



Session Recording 2407

Contents

Session Recording 2407	5
What's new	5
Fixed issues	7
Known issues	8
Third party notices	11
System requirements	11
Get started	14
Plan your deployment	17
Security recommendations	22
Scalability considerations	28
Install, upgrade, and uninstall	40
Dynamic session recording	101
Configure	106
Configure settings on the Session Recording agent	107
Enable or disable recording	107
Enable or disable lossy screen recording	112
Enable fast seeking	116
Configure the connection to the Session Recording server	118
Change your communication protocol	119
Configure settings on the Session Recording server	121
Authorize users	121
CEIP and Google Analytics	123
Customize recording notification messages	127

Enable or disable digital signing	131
Event response reports	132
Session recording storage reports	135
Specify file size for recordings	139
Specify recording storage locations	142
Policies	152
Configure session recording policies	154
Configure recording viewing policies	166
Configure event detection policies	171
Configure event response policies	203
High availability and load balancing	214
Load balance Session Recording servers	215
Configure database high availability	218
View recordings	219
Session Recording player	220
Launch the Session Recording Player	220
Enable or disable live session playback	223
Enable or disable playback protection	224
Search for recordings	224
Place access restrictions on recordings	226
Open and play recordings	229
Cache recordings	236
Highlight idle periods	237
Use events and bookmarks	238

Session Recording web player	240
Access the web player	240
Hide or show content on the web player home page	245
Search for recordings	247
Place access restrictions on recordings	249
Open and play recordings	252
Configure preferences	257
Increase the transport packet size for the web player	258
Highlight idle periods	258
Use events and comments	260
Share recordings as links	262
View graphical event statistics for each recording	268
View data points related to each recorded session	272
Manage recordings	273
Manage and query administrator logging	286
Best practices	294
Configure load balancing in an existing deployment	294
Deploy and load balance Session Recording in Azure	342
Troubleshoot	375
Diagnostic logging	375
Event ID table	378
Installation of server components fails	383
Test connection to the database fails during install	383
Agent cannot connect to the server	383

Server cannot connect to the database	385
Check the recording success rate	386
Sessions are not recording	388
Unable to view live session playback	389
Recordings are corrupted or incomplete	390
Verify component connections	390
Search for recordings using the player fails	393
Record Linux sessions (preview)	396

Session Recording 2407

August 14, 2024

Important:

The product lifecycle strategy for Current Releases (CR) and Long Term Service Releases (LTSR) is described in [Lifecycle Milestones](#).

Session Recording records, catalogs, and archives sessions for retrieval and playback.

Session Recording provides flexible policies to trigger recordings of application and desktop sessions automatically. Session Recording also supports dynamic session recording. Session Recording enables IT personnel to monitor and examine user activity, and so supports internal controls for regulatory compliance and security monitoring. Similarly, Session Recording also aids in technical support by speeding problem identification and time-to-resolution.

Benefits

Enhanced security through logging and monitoring. Session Recording allows organizations to record on-screen user activity for applications that deal with sensitive information, monitoring and preventing the leakage of sensitive information from virtual sessions. Prevention of sensitive information leakage is especially critical in regulated industries such as healthcare and finance.

Powerful activity monitoring. Session Recording captures and archives screen updates, including mouse activity and visible output of keystrokes to provide a record of activity for specific users, applications, and servers.

Session Recording isn't designed for the evidence collection for legal proceedings. However, organizations can use Session Recording together with other techniques for evidence collection, such as conventional video records combined with traditional text-based eDiscovery tools.

Faster problem resolution. When users call with a problem that is difficult to reproduce, help desk support staff can enable recording of user sessions. If the issue recurs, Session Recording provides a time-stamped visual record of the error, which can then be used for faster troubleshooting.

What's new

December 3, 2024

What's new in 2407

This release includes the following new features and addresses [issues](#) to improve the user experience:

Hide screen areas for specific applications during Thinwire screen recording

Previously, hiding screen areas for specific applications was only available for [lossy screen recording](#). Starting with release, you can also hide screen areas for specific applications when recording Thinwire-transmitted session screens.

Tip:

[Thinwire](#), a part of Citrix HDX technology, is the Citrix default display remoting technology used in Citrix Virtual Apps and Desktops. Display remoting technology allows graphics generated on one machine to be transmitted, typically across a network, to another machine for display.

For more information, see [Create a custom recording policy](#).

Capture printing activities in recorded sessions (preview)

We have extended the scope of event detection to monitor printing activities that occur during recorded sessions and tag the printing activities as events in recordings for later search and playback.

To use this feature, make sure that:

- You have configured and activated a session recording policy that specifies sessions to record. For more information, see [Configure session recording policies](#).
- You have created an event detection policy and selected the **Log printing activities** option for it. For more information, see [Create a custom event detection policy](#).

Note:

This is a preview feature. It is available with Session Recording version 2407 and later. Preview features might not be fully localized and are recommended for use in non production environments. Citrix Technical Support doesn't support issues found with preview features.

Report message queue quota exceedance on each VDA to the Session Recording server

In any of the scenarios outlined below, there's a chance of exceeding the maximum size of the Microsoft Message Queuing (MSMQ) directory on a VDA, resulting in packet drops or pushback.

- On the VDA side, the incoming rate of Message Queuing messages exceeds the outgoing rate.
- The network connection between the VDA and the Session Recording server is poor and thus messages are stuck in the queue on the VDA side.
- The queue quota on the Session Recording server side is used up and messages are stuck in the queue on the VDA side.

To facilitate diagnoses and troubleshooting, Session Recording can now capture and report the issues as logs to the Session Recording server for display in the Windows Event Viewer. This feature is enabled by default. You can disable and re-enable the feature by using the following registry value on the target VDA:

HKEY_LOCAL_MACHINE\SOFTWARE\Citrix\SmartAuditor\Agent\DiagnosticLoggingEnabled

Value data: 1 = enabled, 0 = disabled

You can also set how long these logs can be retained on the Session Recording database. To do so, go to the **Logging** tab of Session Recording Server Properties and configure the **Retention period for diagnostic logs**. The default value is 30 days.

For more information, see [Diagnostic logging](#).

Dynamic screen recording through Citrix PowerShell SDKs extended to event-only recording

You can run PowerShell commands that Citrix SDKs provide to **start recording the screen** at any time during a session. Previously, this feature was unavailable for sessions that fall into the scope of an event-only recording policy. Starting with this release, you can run PowerShell commands to dynamically turn an event-only recording into a screen recording so that the screen is also captured in addition to the target events.

For more information, see [Configure session recording policies](#) and [Dynamically start or stop recording by using PowerShell commands in the Citrix SDKs](#).

What's new in earlier releases

For new features included in the releases that shipped after the 1912 LTSR through the 2402 LTSR, see [What's new history](#).

Fixed issues

December 3, 2024

Compared with: Session Recording 2402 LTSR

Session Recording 2407 adds the following fixes:

- When viewing recordings in the player, you might encounter an error message indicating missing data from the recording process, along with a data loss warning in the Event logs (Event ID: 2005) on the Session Recording server. [SRT-12682] [SRT-12707]
- When you disable a rule for an event response policy on the Session Recording policy console, all configurations associated with the rule might be deleted. [SRT-12037]
- When you use Microsoft Edge to access the website **http://<SR Server>/WebPlayer/#/logging/config**, the browser incorrectly opens 3 sign-in windows. [SRT-12274]
- The web player might not support playing the recording files stored in **C:\SessionRecordingsRestored**. [SRT-12599]
- The web player is unable to play recordings when its URL contains the word “cloud.” [SRT-12045]

Known issues

December 3, 2024

The following issues have been identified in this release:

- The [H.264 package dropping feature](#) might not work as expected.
- Attempts to install additional Session Recording servers and connect them to the same Session Recording database might fail when SQL server authentication is selected. The issue doesn't affect the first Session Recording server installed and connected to the Session Recording database, but it does affect subsequent Session Recording servers. To work around the issue, you can install the additional Session Recording servers using a command similar to the following:

```
1  msixexec /i "SessionRecordingAdministrationx64.msi" ADDLOCAL="
    SsRecServer,PolicyConsole,SsRecLogging,StorageDatabase"
    DATABASEINSTANCE="DatabaseConnectionString" DATABASENAME="
    CitrixSessionRecording" LOGGINGDATABASENAME="
    CitrixSessionRecordingLogging" AZURESQLSERVICESUPPORT="1"
    CLOUDDBSUPPORT="1" AZUREUSERNAME="CloudSQLAdminName"
    AZUREPASSWORD="CloudSQLAdminPassword" /q /l*vx "c:\WithLogging
    .log"
```

[SRT-12976]

- If you are using [Citrix Web App Firewall \(WAF\) signatures to mitigate in part the CVE-2021-44228 vulnerability](#), Session Recording might not work as expected. To resolve the issue, exclude the IP addresses of your Session Recording servers from the **mitigate_cve_2021_44228** policy on the NetScaler side. [CVADHELP-24365]

- Attempts to save the Session Recording policy settings might fail and you can obtain the following error message by using [CDFControl](#):

```
1 This operation is blocked. Session Recording Administrator
  Logging failed. The formatter threw an exception while trying
  to deserialize the message: There was an error while trying to
  deserialize parameter http://tempuri.org/:operation. The
  InnerException message was 'There was an error deserializing
  the object of type SmAudLoggingInterface.LogOperation. The
  maximum string content length quota (8192) has been exceeded
  while reading XML data. This quota may be increased by
  changing the MaxStringContentLength property on the
  XmlDictionaryReaderQuotas object used when creating the XML
  reader. Line 186, position 62.'. Please see InnerException for
  more details.
```

To address the issue, perform one of the following operations:

- Add an HTTPS site binding in IIS for communication with the Session Recording server. For example:

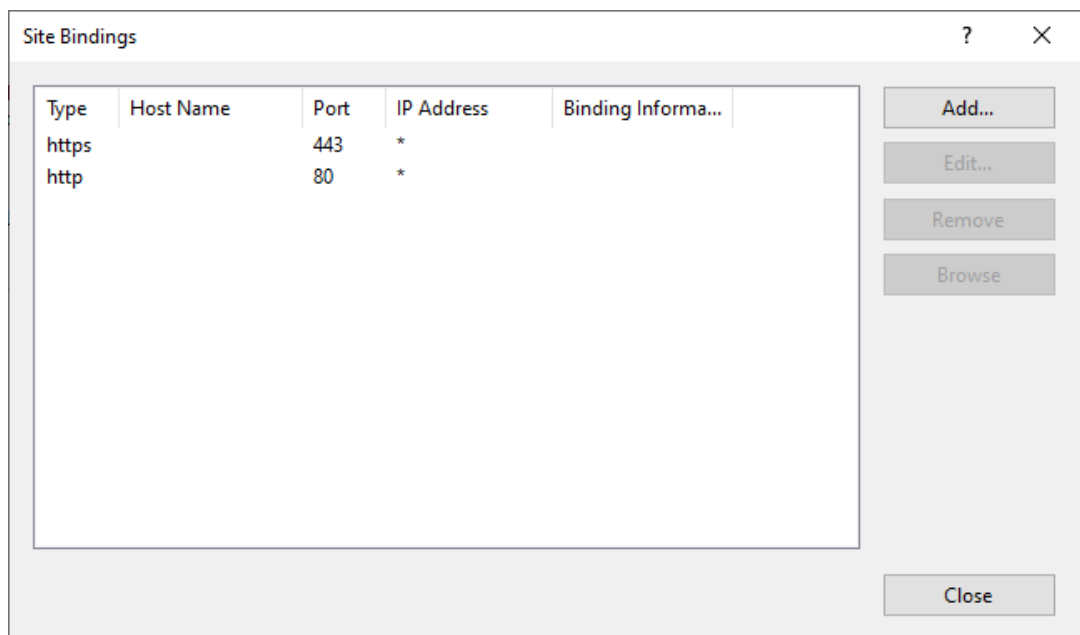

- Add the following lines to the Web.config file available in C:\Program Files\Citrix\SessionRecording\Log

```
1 <readerQuotas maxDepth="32" maxStringContentLength="5242880"
  maxArrayLength="16384" maxBytesPerRead="4096"
  maxNameTableCharCount="16384" />
```

```

Web.config - Notepad
File Edit Format View Help
<?xml version="1.0" encoding="utf-8"?>
<configuration>
  <system.serviceModel>
    <protocolMapping>
      <add scheme="http" binding="wsHttpBinding" bindingConfiguration="MessageSecurity" />
      <add scheme="https" binding="wsHttpBinding" bindingConfiguration="TransportSecurity" />
    </protocolMapping>
    <bindings>
      <wsHttpBinding>
        <binding name="TransportSecurity">
          <security mode="Transport">
            <message clientCredentialType="Windows" />
          </security>
          <readerQuotas maxDepth="32" maxStringContentLength="5242880" maxArrayLength="16384" maxBytesPerRead="4096"
maxNameTableCharCount="16384" />
        </binding>
        <binding name="MessageSecurity">
          <security mode="Message">
            <message clientCredentialType="Windows" establishSecurityContext="false" />
          </security>
          <readerQuotas maxDepth="32" maxStringContentLength="5242880" maxArrayLength="16384" maxBytesPerRead="4096"
maxNameTableCharCount="16384" />
        </binding>
      </wsHttpBinding>
    </bindings>
    <behaviors>
      <serviceBehaviors>
        <behavior>
          <serviceDebug includeExceptionDetailInFaults="False" />
          <serviceAuthorization principalPermissionMode="UseAspNetRoles" roleProviderName="AuthorizationStoreRoleProvider"
/ >
        </behavior>
      </serviceBehaviors>
    </behaviors>
    <serviceHostingEnvironment multipleSiteBindingsEnabled="True" />
  </system.serviceModel>
  <system.web>
    <compilation debug="False" />
  </system.web>
</configuration>
Ln 14, Col 4      100%  Windows (CRLF)  UTF-8 with BOM

```

[SRT-11791]

- Attempts to close unresponsive or dormant live recordings automatically or manually by using the ICLDB DORMANT command might fail. The issue occurs when you update Session Recording to 2308 instead of doing a fresh installation. To resolve the issue, run the following script in PowerShell on the Session Recording server machine and ensure that you have administrative access to the Session Recording database:

```

1 Add-Type -AssemblyName System.data
2 $registryKey = [Microsoft.Win32.Registry]::LocalMachine.
   OpenSubKey("SOFTWARE\Citrix\SmartAuditor\Server")
3 $dbName = $registryKey.GetValue("DatabaseName")
4 $dbInstance = $registryKey.GetValue("SmAudDatabaseInstance")
5 write-host "Connecting to $dbInstance\$dbName"
6 # Connect db
7 $conn = New-Object System.Data.SqlClient.SqlConnection
8 $conn.ConnectionString = "workstation id=.;packet size=4096;
   integrated security=SSPI;data source=$dbInstance;persist
   security info=True;initial catalog=$dbName"
9 $conn.Open()
10 $cmd = $conn.CreateCommand()
11 $cmd.CommandText = "use [$dbName];if not exists(select * from [
   dbo].[EndReason] where ID=5) begin insert [dbo].[EndReason]
   values (5, 'Dormant') end"
12 $cmd.ExecuteNonQuery()

```

[SRT-11119]

- Session Recording doesn't capture file transfers between a native disk on the session host (VDA) and a disk that's mapped to the session from the client. [SRT-10514]
- When you upgrade Session Recording to the latest version, your **image resolution scaling** settings for **lossy screen recording** are lost and the default value 1.0 is restored. [SRT-10130]
- A domain user with local administrator privileges on the Session Recording policy console can add local and domain users to which the action of a policy rule applies. However, a local user with local administrator privileges can add only local users but not domain users. [SRT-5769]
- The web player might not work properly if you upgrade it from Version 2009 or earlier. To work around the issue, clear your browser cache. [SRT-5624]
- Rules of custom policies might be lost after you update Session Recording from the version included in XenApp and XenDesktop 7.6 LTSR to the latest version. As a workaround, update the software to the version included in the latest CU of XenApp and XenDesktop 7.15 LTSR and then update it to the latest release. [SRT-4546]
- When Machine Creation Services (MCS) or Citrix Provisioning (PVS) creates multiple VDAs with Microsoft Message Queuing (MSMQ) installed, those VDAs can have the same **QMID**. This condition might cause various issues, for example:
 - Sessions might not be recorded even if the recording agreement is accepted.
 - The Session Recording server might not be able to receive session-logout signals and therefore, sessions might always be in a live state.

For information about a workaround, see [Install, upgrade, and uninstall](#). [#528678]

Third party notices

December 3, 2024

[Session Recording Version 2407](#) (PDF Download)

This release of Session Recording can include third party software licensed under the terms defined in this document.

System requirements

December 3, 2024

Session Recording includes the Session Recording Administration components, the Session Recording agent, and the Session Recording player. You can install the Session Recording Administration components (Session Recording database, Session Recording server, and Session Recording policy console) on a single server or on different servers. The following section details the requirements for each of the Session Recording components.

For information about using this Current Release (CR) in a Long Term Service Release (LTSR) environment and other FAQs, see [Knowledge Center article](#).

Session Recording database

Supported operating systems:

- Windows Server 2025
- Windows Server 2022
- Windows Server 2019

Supported Microsoft SQL Server versions:

- Microsoft SQL Server 2022 Enterprise, Express, and Standard editions
- Microsoft SQL Server 2019 Enterprise, Express, and Standard editions
- Microsoft SQL Server 2017 Enterprise, Express, and Standard editions
- Microsoft SQL Server 2016 SP2 Enterprise, Express, and Standard editions

Supported Azure SQL database services:

- Azure SQL Managed Instance
- SQL Server on Azure Virtual Machines (VMs)
(Use supported versions of Microsoft SQL Server that are listed earlier.)
- Azure SQL Database

Supported AWS RDS database services:

- SQL Server

Supported database collations:

- Collations ending with `_CI_AS`

Requirement: .NET Framework 4.7.2

Session Recording server

Supported operating systems:

- Windows Server 2025
- Windows Server 2022
- Windows Server 2019

Other requirements:

- Internet Information Services (IIS) 10, 8.5, 8.0, or 7.5
- .NET Framework Version 4.7.2
- If the Session Recording server uses HTTPS as its communications protocol, add a valid certificate. Session Recording uses HTTPS by default, which Citrix recommends.
- Microsoft Message Queuing (MSMQ), with Active Directory integration disabled and MSMQ HTTP support enabled.
- For Administrator Logging: Latest version of Chrome, Firefox, or Internet Explorer 11

Session Recording policy console

Supported operating systems:

- Windows Server 2025
- Windows Server 2022
- Windows Server 2019

Requirement: .NET Framework 4.7.2

Session Recording agent

Install the Session Recording agent on every Windows Virtual Delivery Agent (VDA) on which you want to record sessions.

Supported operating systems:

- Windows Server 2025
- Windows Server 2022
- Windows Server 2019
- Windows 11
- Windows 10, minimum version 1607
- Windows 10 Enterprise for Virtual Desktops

Requirements:

- Citrix Virtual Apps and Desktops 7 2203 with Premium license
- Citrix Virtual Apps and Desktops 7 1912 LTSR CU4 or later with Platinum license
- XenApp and XenDesktop 7.15 LTSR CU8 with Platinum license

- .NET Framework 4.7.2
- Microsoft Message Queuing (MSMQ), with Active Directory integration disabled and MSMQ HTTP support enabled

Note:

Session Recording currently supports Citrix DaaS (formerly Citrix Virtual Apps and Desktops service) Advanced, Advanced Plus, Premium, and Premium Plus editions.

Session Recording player

Supported operating systems:

- Windows Server 2025
- Windows Server 2022
- Windows Server 2019
- Windows 11
- 64-bit Windows 10, minimum version 1607

Requirement: .NET Framework 4.7.2

Note:

On 32-bit Windows 10, you can install the player only by using the SessionRecordingPlayer.msi file. You can find the msi file on the Citrix Virtual Apps and Desktops ISO under `\x86\Session Recording`.

For optimal results, install the Session Recording player on a workstation with:

- Screen resolution of 1024 x 768
- Color depth of at least 32-bit
- 2 GB RAM minimum; more RAM and CPU/GPU resources can improve performance when playing graphics-intensive recordings, especially when recordings contain many animations

The seek response time depends on the size of the recording and your machine's hardware specifications.

Get started

December 3, 2024

Session Recording consists of five components:

Session Recording components

Session Recording consists of the following components:

- **Session Recording Administration components:**
 - **Session Recording policy console.** A console used to configure policies such as session recording policies that specify which sessions to record. For more information, see [Policies](#).
 - **Session Recording server.** A server that hosts:
 - * The Broker. An IIS 6.0+ hosted Web application that serves the following purposes:
 - Handling search queries and file download requests from the Session Recording player and web player.
 - Handling policy administration requests from the Session Recording policy console.
 - Evaluating recording policies for each Citrix Virtual Apps and Desktops or Citrix DaaS (formerly Citrix Virtual Apps and Desktops service) session.
 - * The Storage Manager. A Windows service that manages the recorded session files received from each Session Recording-enabled VDA.
 - * **Administrator logging.** An optional subcomponent installed with the Session Recording server to log the administration activities. All the logging data is stored in a separate SQL Server database named **CitrixSessionRecordingLogging** by default. You can customize the database name.
 - **Session Recording database.** A component that manages the SQL Server database for storing recorded session data. When this component is installed, it creates a database named **CitrixSessionRecording** by default. You can customize the database name.
- **Session Recording agent.** A component installed on each VDA for multi-session OS or single-session OS to enable recording. It is responsible for recording session data.
- **Session Recording player / web player.** A user interface that users access from a workstation to play recorded session files.

To install Session Recording or upgrade an existing installation, go to each machine where you are about to or have already installed the Session Recording components and then run the Citrix Virtual Apps and Desktops ISO.

Tip:

Go to the [Citrix Virtual Apps and Desktops download page](#) to download the appropriate version of Citrix Virtual Apps and Desktops.

For more information about installing Session Recording, see [Install, upgrade, and uninstall](#). You can also refer to the Citrix Tech Zone article [POC Guide: Citrix Session Recording](#) for information on how to quickly set up and configure Citrix Session Recording and Citrix Session Recording service.

Example deployment

The following diagram shows an example deployment:

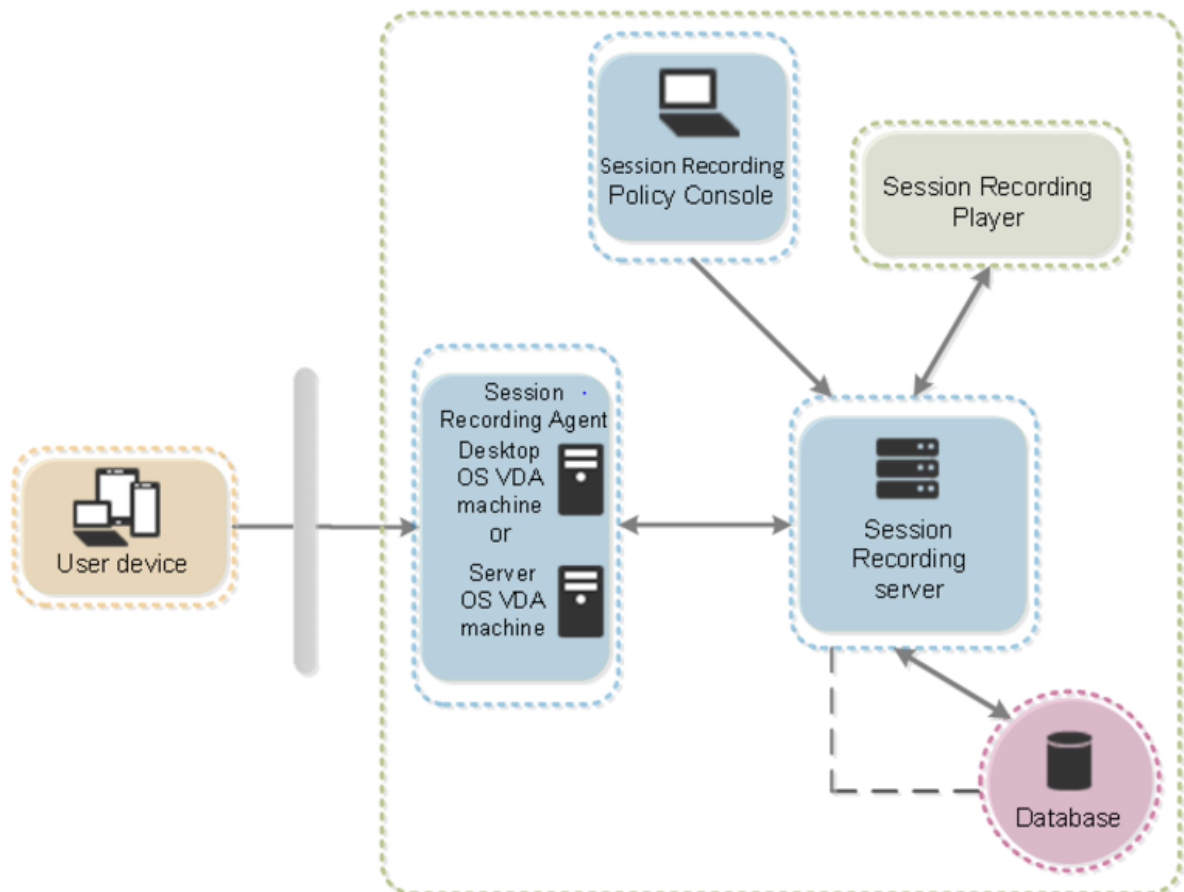

- All the Session Recording components reside behind a security firewall.
- The Session Recording agent is installed on a VDA for multi-session OS or single-session OS.
- A second server hosts the Session Recording policy console, a third server acts as the Session Recording server, and a fourth server hosts the database.
- The Session Recording player is installed on a workstation. Installing the Session Recording server lets you install the Session Recording web player automatically.
- A client device outside the firewall communicates with the VDA where the Session Recording agent is installed.
- Inside the firewall, the Session Recording agent, policy console, player, and database all communicate with the Session Recording server.

Plan your deployment

December 3, 2024

Limitations and caveats

Session Recording doesn't support Desktop Composition Redirection (DCR) display mode. By default, Session Recording disables DCR in a session to be recorded. You can configure this behavior in **Session Recording Agent properties**.

When you browse URLs configured in the [browser content redirection policy](#) in Internet Explorer, graphics activities are not recorded.

Session Recording does not support the Framehawk display mode. Sessions in Framehawk display mode cannot be recorded and played back correctly. Sessions recorded in Framehawk display mode might not contain the sessions' activities.

Session Recording can't record the Lync webcam video when using the HDX RealTime Optimization Pack.

Depending upon your environment, you can deploy the Session Recording components in different scenarios.

A Session Recording deployment is not limited to a single site. Except the Session Recording agent, all components are independent of the server site. For example, you can configure multiple sites to use a single Session Recording server.

A single Session Recording server might experience a high performance demand. For example, you might have a large site with many agents and plan to record many sessions or many graphically intense applications such as AutoCAD. To alleviate performance issues, you can install multiple Session Recording servers and configure load balancing.

Ports

Source	Destination	Type	Port	Details
Virtual Delivery Agent	Session Recording server	TCP	80, 443	Communication between the Session Recording agent installed on Virtual Delivery Agent and the Session Recording server. Default installation uses HTTPS/SSL to secure communications. If SSL is not configured, use HTTP.

Source	Destination	Type	Port	Details
Virtual Delivery Agent	Session Recording server	TCP	1801	By default, Session Recording uses TCP as the communication protocol and thus MSMQ uses port 1801 for sending messages over TCP. Alternatively, MSMQ can use port 80 or 443 for sending messages over HTTP or HTTPS based on your protocol setting on the Connections tab of Session Recording Agent Properties .
Session Recording policy console	Session Recording server	TCP	80, 443	Communication between the server where the Session Recording policy console is installed and the Session Recording server.

Source	Destination	Type	Port	Details
Session Recording player	Session Recording server	TCP	80,443	Communication between the workstation where the Session Recording player is installed and the Session Recording server.
Session Recording server	Microsoft SQL Server	TCP	1433	Connection to the Session Recording database.

Suggested server site deployment

Use this type of deployment for recording sessions for one or more sites. The Session Recording agent is installed on each VDA in a site. The site resides in a data center behind a security firewall. The Session Recording Administration components (Session Recording database, Session Recording server, and Session Recording policy console) are installed on other servers and the Session Recording player is installed on a workstation, all behind the firewall. It is recommended to deploy the Session Recording server in a secure, intranet data center.

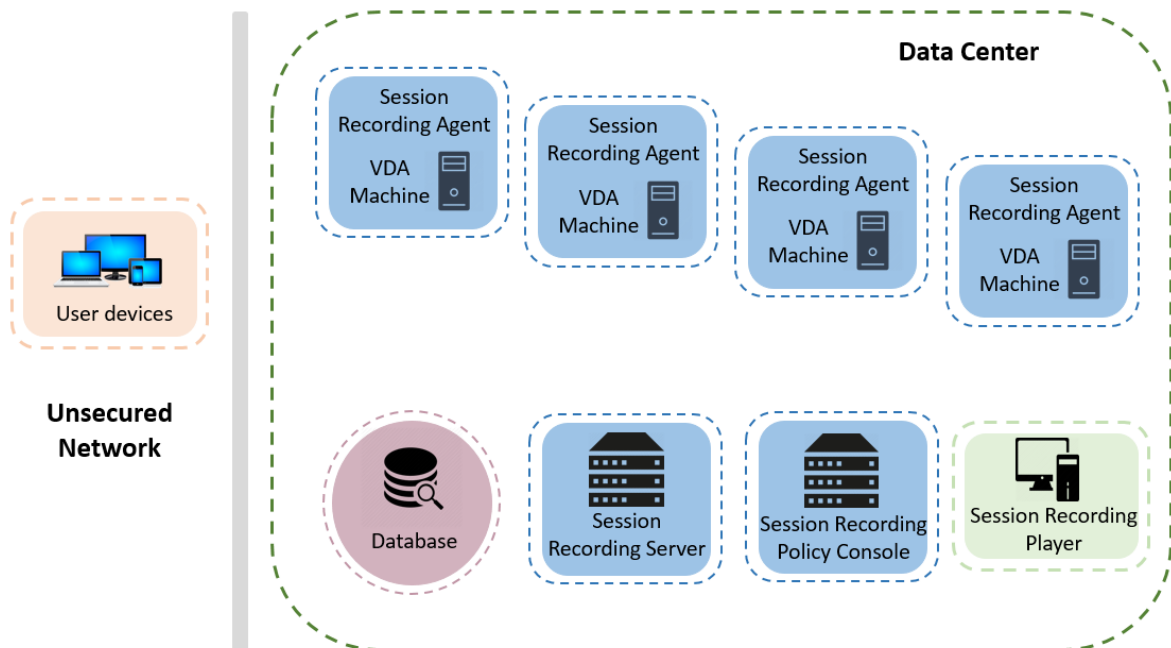

Important deployment notes

- To enable Session Recording components to communicate with each other, install them in the same domain or across trusted domains that have a transitive trust relationship. The system cannot be installed on a workgroup or across domains that have an external trust relationship.
- Considering its intense graphical nature and memory usage when playing back large recordings, we do not recommend installing the Session Recording Player as a published application.
- The Session Recording installation is configured for TLS/HTTPS communication. Install a certificate on the Session Recording server. Make sure the root certificate authority (CA) is trusted on the Session Recording components.
- For the Session Recording server on a standalone server running SQL Server, enable the TCP/IP protocol and run the SQL Server Browser service. These settings are disabled by default, but they must be enabled for the Session Recording server to communicate with the database. For more information, see the Microsoft articles [Enable TCP/IP Network Protocol for SQL Server](#) and [SQL Server Browser service](#).
- Consider the effects of session sharing when planning your Session Recording deployment. Session sharing for published applications can conflict with Session Recording policy rules for published applications. Session Recording matches the active policy with the first published application that a user opens. After the user opens the first application, any subsequent applications opened during the same session continue to follow the policy that is in force for the first application. For example, if a policy states to record only Microsoft Outlook, the recording commences when the user opens Outlook. If the user opens a published Microsoft Word second while Out-

look is running, Word also is recorded. Conversely, if the active policy doesn't specify to record Word and the user launches Word before Outlook, Outlook is not recorded.

- Though you can install the Session Recording server on a Delivery Controller, we don't recommend it because of performance issues.
- You can install the Session Recording Policy Console on a Delivery Controller.
- You can install both the Session Recording server and the Session Recording Policy Console on the same system.
- Ensure that the NetBIOS name of the Session Recording server does not exceed the limit of 15 characters. Microsoft has a 15-character limit on the host name length.
- PowerShell 5.1 or later is required for custom event logging. Upgrade PowerShell if you install the Session Recording agent on Windows Server 2012 R2 that has PowerShell 4.0 installed. Failure to comply can cause failed API calls.
- For step-by-step instructions on deploying and configuring the Citrix Session Recording and Citrix Session Recording service, see this Citrix Tech Zone article: [POC Guide: Citrix Session Recording](#).

Security recommendations

December 3, 2024

Session Recording is deployed within a secure network and accessed by administrators, and as such, is secure. Out-of-the-box deployment is simple and security features such as digital signing and encryption can be configured optionally.

Communication between Session Recording components is achieved through Internet Information Services (IIS) and Microsoft Message Queuing (MSMQ). IIS provides the web services communication link between Session Recording components. MSMQ provides a reliable data transport mechanism to send recorded session data from the Session Recording agent to the Session Recording server.

Warning:

Editing the registry incorrectly can cause serious problems that might require you to reinstall your operating system. Citrix cannot guarantee that problems resulting from the incorrect use of **Registry Editor** can be solved. Use **Registry Editor** at your own risk. Be sure to back up the registry before you edit it.

Consider these security recommendations when planning your deployment:

- Configure Microsoft Internet Information Services (IIS).

You can configure Session Recording with a restricted IIS configuration. On each Session Recording server, open the IIS Manager and set the following recycling limits for each IIS application pool:

- **Virtual Memory Limit:** Set the value to 4,294,967,295.
- **Private Memory Limit:** Set the value to the physical memory of the Session Recording server. For example, if the physical memory is 4 GB, set the value to 4,194,304.
- **Request Limit:** We recommend you leave this setting unspecified. Or you can set the value to 4,000,000,000.

Tip:

To access the preceding settings, highlight each application pool, select **Advanced Settings** in the **Actions** pane, and then scroll down to the **Recycling** section in the **Advanced Settings** dialog box.

- Ensure that you properly isolate the different administrator roles in the corporate network, in the Session Recording system, or on individual machines. By not doing so, security threats that can impact the system functionality or abuse the system might occur. We recommend that you assign different administrator roles to different persons or accounts. Do not allow general session users to have administrator privileges to the VDA system.
 - Do not grant VDA local administrator role to any users of published apps or desktops. If the local administrator role is a requirement, protect the Session Recording agent components by using Windows mechanisms or third-party solutions.
 - Separately assign the Session Recording database administrator and Session Recording policy administrator.
 - Do not assign VDA administrator privileges to general session users, especially when using Remote PC Access.
 - The Session Recording server's local administration account must be strictly protected.
 - Control access to machines where the Session Recording player is installed. If a user is not authorized for the Player role, do not grant that user the local administrator role for any player machine. Disable anonymous access.
 - We recommend using a physical machine as a storage server for Session Recording.
- Session Recording records session graphics activities without regard to the sensitivity of the data. Under certain circumstances, sensitive data (including but not limited to user credentials, privacy information, and third-party screens) might be recorded unintentionally. Take the following measures to prevent risks:
 - Disable core memory dump for VDAs unless for specific troubleshooting cases.
To disable core memory dump:
 1. Right-click **My Computer**, and then select **Properties**.

2. Click the **Advanced** tab, and then under **Startup and Recovery**, click **Settings**.
 3. Under **Write Debugging Information**, select **(none)**.
 - See the Microsoft article at <https://support.microsoft.com/en-us/kb/307973>.
- Session owners notify attendees that online meetings and remote assistance software might be recorded if a desktop session is being recorded.
 - Ensure that logon credentials or security information does not appear in all local and Web applications published or used inside the corporation. Otherwise, they are recorded by Session Recording.
 - Close any application that might expose sensitive information before switching to a remote ICA session.
 - We recommend only automatic authentication methods (for example, single sign-on, smartcard) for accessing published desktops or Software as a Service (SaaS) applications.
- Session Recording relies on certain hardware and hardware infrastructure (for example, corporate network devices, operation system) to function properly and to meet security needs. Take measures at the infrastructure levels to prevent damage or abuse to those infrastructures and make the Session Recording function secure and reliable.
 - Properly protect and keep network infrastructure supporting Session Recording available.
 - We recommend using a third-party security solution or Windows mechanism to protect Session Recording components. Session Recording components include:
 - ★ On the Session Recording server
 - Processes: SsRecStoragemanager.exe and SsRecAnalyticsService.exe
 - Services: CitrixSsRecStorageManager and CitrixSsRecAnalyticsService
 - All files in the Session Recording server installation folder
 - Registry values within HKEY_LOCAL_MACHINE\SOFTWARE\Citrix\SmartAuditor\Server
 - ★ On the Session Recording agent
 - Process: SsRecAgent.exe
 - Service: CitrixSmAudAgent
 - All files in the Session Recording agent installation folder
 - Registry values under [HKEY_LOCAL_MACHINE\SOFTWARE\Citrix\SmartAuditor\Agent](#)
- As a security best practice, Citrix recommends using HTTPS on IIS.
 - Set the access control list (ACL) for Message Queuing (MSMQ) on the Session Recording server to restrict VDA or VDI machines that can send MSMQ data to the Session Recording server and prevent unauthorized machines from sending data to the Session Recording server.
 1. Install server feature **Directory Service Integration** on each Session Recording server and VDA or VDI machine where Session Recording is enabled. Then restart the **Message Queuing** service.

2. From the Windows **Start** menu on each Session Recording server, open **Administrative Tools > Computer Management**.
3. Open **Services and Applications > Message Queuing > Private Queues**.
4. Click the private queue **citrixsmauddata** to open the **Properties** page and select the **Security** tab.

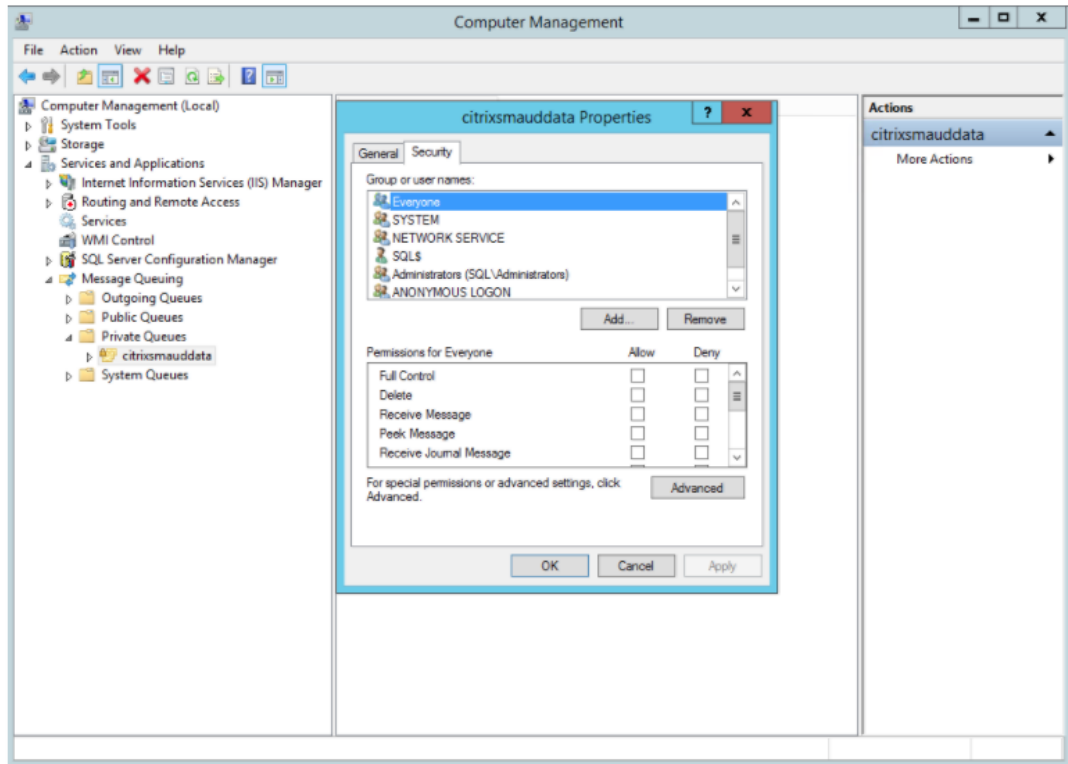

5. Add the computers or security groups of the VDAs that send MSMQ data to this server and grant them the **Send Message** permission.

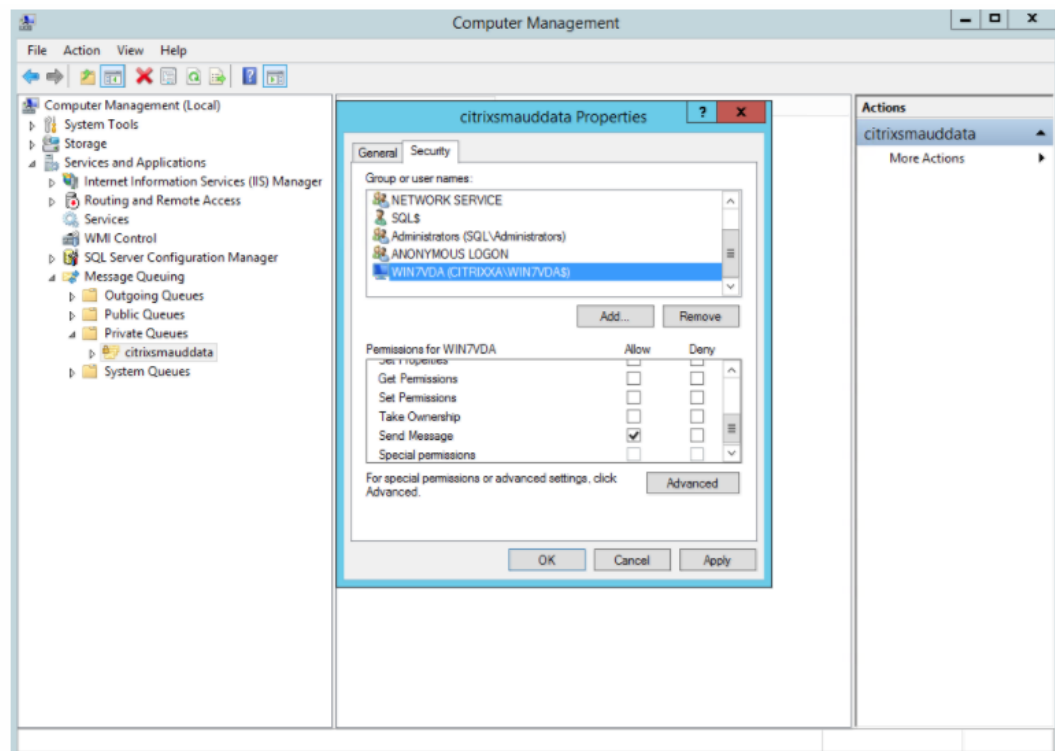

- Properly protect the event log for the Session Record server and Session Recording agents. We recommend using a Windows or third-party remote logging solution to protect the event log or redirect the event log to the remote server.
- Ensure that servers running the Session Recording components are physically secure. If possible, lock these computers in a secure room to which only authorized personnel can gain direct access.
- Isolate servers running the Session Recording components on a separate subnet or domain.
- Protect the recorded session data from users accessing other servers by installing a firewall between the Session Recording server and other servers.
- Keep the Session Recording Administration Server and SQL database up-to-date with the latest security updates from Microsoft.
- Restrict non-administrators from logging on to the administration machine.
- Strictly limit who is authorized to make recording policy changes and view recorded sessions.
- Install digital certificates, use the Session Recording file signing feature, and set up TLS communications in IIS.
- Set up MSMQ to use HTTPS as its transport. The way is to set the MSMQ protocol listed in **Session Recording Agent Properties** to HTTPS. For more information, see [Troubleshoot MSMQ](#).

- Use TLS 1.1 or TLS 1.2 (recommended) and disable SSLv2, SSLv3, TLS 1.0 on the Session Recording server and Session Recording Database.
- Disable RC4 cipher suites for TLS on the Session Recording server and Session Recording database:
 1. Using the Microsoft Group Policy Editor, navigate to **Computer Configuration > Administrative Templates > Network > SSL Configuration Settings**.
 2. Set the **SSL Cipher Suite Order** policy to **Enabled**. By default, this policy is set to **Not Configured**.
 3. Remove any RC4 cipher suites.
- Use playback protection. Playback protection is a Session Recording feature that encrypts recorded files before they are downloaded to the Session Recording player. By default, this option is enabled and is in **Session Recording Server Properties**.
- Follow NSIT guidance for cryptographic key lengths and cryptographic algorithms.
- Configure TLS 1.2 support for Session Recording.

We recommend using TLS 1.2 as the communication protocol to ensure the end-to-end security of the Session Recording components.

To configure TLS 1.2 support of Session Recording:

1. Log on to the machine hosting the Session Recording server. Install the proper SQL Server client component and driver, and set strong cryptography for **.NET Framework** (version 4 or later).
 - a) Install the Microsoft ODBC Driver 11 (or a later version) for SQL Server.
 - b) Apply the latest hotfix rollup of **.NET Framework**.
 - c) Install **ADO.NET – SqlClient** based on your version of **.NET Framework**. For more information, see <https://support.microsoft.com/en-us/kb/3135244>.
 - d) Add a DWORD value `SchUseStrongCrypto=1` under `HKEY_LOCAL_MACHINE\SOFTWARE\Microsoft\` and `HKEY_LOCAL_MACHINE\SOFTWARE\Wow6432Node\Microsoft\`.`.NetFramework\v4.0.30319`.
 - e) Restart the machine.
2. Log on to the machine hosting the Session Recording policy console. Apply the latest hotfix rollup of **.NET Framework**, and set strong cryptography for **.NET Framework** (version 4 or later). The method for setting strong cryptography is the same as substeps 1–4 and 1–5. You can omit these steps if you choose to install the Session Recording policy console on the same computer as the Session Recording server.

To configure the TLS 1.2 support for SQL Server with versions earlier than 2016, see <https://support.microsoft.com/en-us/kb/3135244>. To use TLS 1.2, configure HTTPS as the communication protocol for the Session Recording components.

Scalability considerations

December 3, 2024

Session Recording is a highly scalable system that handles thousands or tens of thousands of sessions. Installing and running Session Recording requires few extra resources beyond what is necessary to run Citrix Virtual Apps and Desktops or Citrix DaaS (formerly Citrix Virtual Apps and Desktops service). However, we still recommend you consider the performance of your system if you plan to record many sessions. Or, the sessions you plan to record might result in large session files (for example, graphically intense applications).

This article explains how Session Recording achieves high scalability and how you can get the most out of your recording system at a lowest cost.

Why Session Recording scales well

There are two major reasons that Session Recording scales well compared with competitive products:

- Small file size

A recorded session file made with Session Recording is highly compact. It is many orders of magnitude smaller than an equivalent video recording made with solutions that screen-scrape. The network bandwidth, disk space, and disk IOPS required to transport/store a recorded session file is typically at least 10 times less than an equivalent video file.

The small size of recorded session files means faster and smoother rendering of video frames. Recordings are also lossless and have no pixelation that is common in most compact video formats. Text in recordings is easy to read during playback as it is in the original sessions. To maintain small file sizes, Session Recording does not record key frames within the files. Session Recording can drop H.264 packages while recording sessions that have videos running and thus reduce the recording file sizes. This feature is incompatible with the [Compressed recording](#) feature. To use this feature, set `HKEY_LOCAL_MACHINE\SOFTWARE\Citrix\SmartAuditor\Agent\DropH264Enabled` to 1 on the Session Recording agent and set the value of **Use video codec for compression** to **For actively changing regions**.

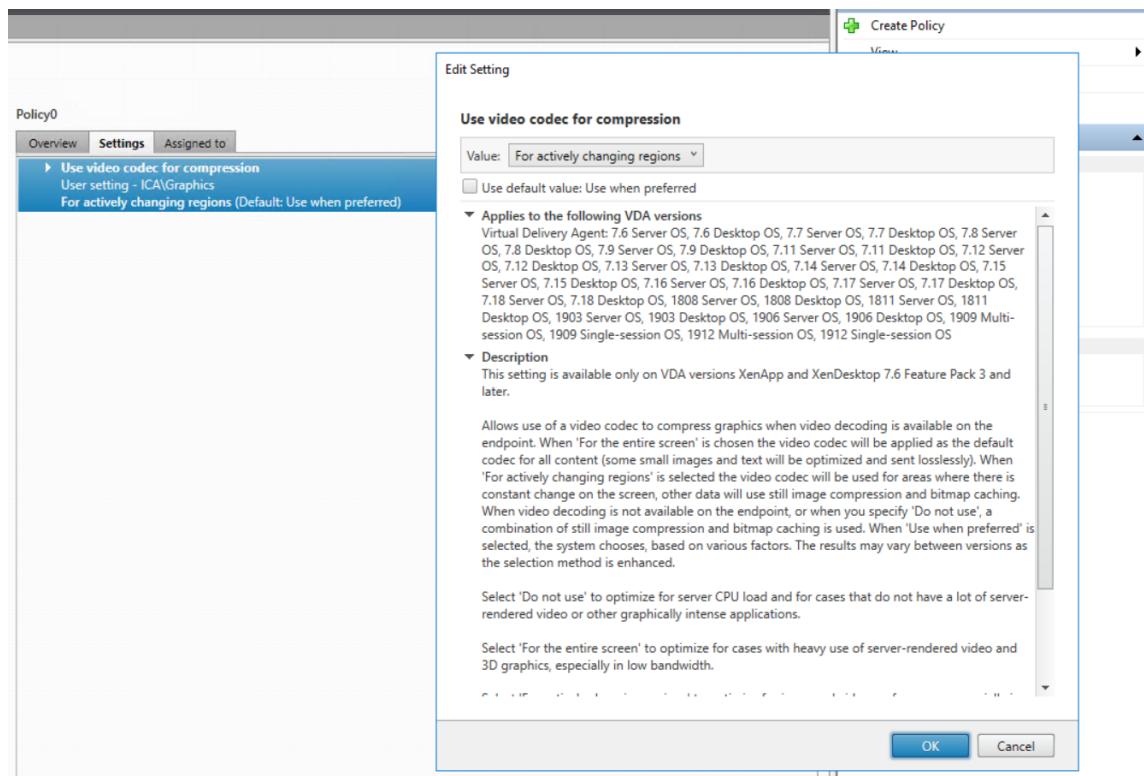

- Low processing required to generate files

A recorded session file contains the ICA protocol data for a session that is extracted virtually in its native format. The file captures the ICA protocol data stream that is used to communicate with Citrix Workspace app. There is no need to run expensive transcoding or encoding software components to change the format of data in real time. The low amount of processing is also important for VDA scalability. It ensures the end-user experience is maintained when many sessions are recorded from the same VDA.

Moreover, only those ICA virtual channels that can be played back are recorded, which results in a further optimization. For example, the printer and client drive mapping channels aren't recorded. The channels can generate high volumes of data without any benefit in video playback.

Estimate data input and processing rates

The Session Recording server is the central collection point for recorded session files. Each machine that is running a multi-session OS VDA with Session Recording enabled sends recorded session data to the Session Recording server. Session Recording can handle high volumes of data and can tolerate bursts and faults. But there are physical limits on how much data any one server can handle.

Consider how much data you send to each Session Recording server. Estimate how quickly the servers can process and store the data. The rate at which your system can store incoming data must be higher

than the data input rate.

To estimate your data input rate, do the following calculation:

1. Multiply the number of recorded sessions by the average session size.
2. Divide the product by the time for which you are recording sessions.

For example, you might record 5,000 Microsoft Outlook sessions of 20 MB each over an 8-hour work day. In this case, the data input rate is approximately 28 Mbps (5,000 sessions multiplied by 20 MB, divided by 8 hours, divided by 3,600 seconds per hour, and multiplied by 8 for conversion to Mbps). A typical Session Recording server connected to a 100 Mbps LAN with sufficient disk space to store the recorded data can process data at around 5.0 Mbps. This rate is the processing rate based on the physical limits imposed by disk and network IOPS. In the example, the processing rate (5.0 Mbps) is lower than the input rate (28 Mbps), so recording the 5,000 Outlook sessions is impossible.

The amount of data per session varies greatly depending on what is being recorded. Other factors such as screen resolution, color depth, and graphics mode also have impacts. A session where CAD is running likely generates a much larger recording than a session where the user sends and receives emails in Outlook. Therefore, recording the same number of CAD sessions can generate a high input rate and require the use of more Session Recording servers.

Bursts and faults

The previous example assumes a simple uniform throughput of data but doesn't explain how the system deals with short periods of higher activity, known as bursts. A burst might occur when all users log on at the same time in the morning, known as the 9 o'clock rush. It can also occur when they receive the same email in their Outlook inbox at once. The 5.0 Mbps processing rate of the Session Recording server is highly inadequate at dealing with this sudden demand.

The Session Recording agent running on each VDA uses Microsoft Message Queuing (MSMQ) to send recorded data to the Storage Manager running on the central Session Recording server. The data is sent in a store-and-forward manner similar to how an email is delivered between the sender, mail server, and receiver. If the Session Recording server or network can't handle a high rate of data in bursts, the recorded data is temporarily stored. The data message might be temporarily stored in the outgoing queue on the VDA if the network is congested. The other case is that the data has traversed the network but the Storage Manager is busy processing other messages. In this case, the data message is stored on the Session Recording server's receiving queue.

MSMQ also serves as a fault tolerance mechanism. If the Session Recording server goes down or the link is broken, recorded data stays in the outgoing queue on each VDA. When the fault is rectified, all queued data is sent together. MSMQ also allows you to take a server offline for upgrade or maintenance without interrupting session recording and losing data.

The main limitation of MSMQ is that disk space for the temporary storage of data messages is finite. This limitation limits how long a burst, fault, or maintenance event can last before data is eventually lost. The overall system can continue after data loss, but in this situation, individual recordings have chunks of data missing. A file with missing data is still playable but only up to the point where data was first lost. Note the following:

- Adding more disk space to each server, especially the Session Recording server, and making it available to MSMQ can increase the tolerance to bursts and faults.
- It is important to configure the Message Life setting for each Session Recording agent to an appropriate level (on the **Connections** tab in Session Recording agent Properties). The default value is 7,200 seconds (two hours). It means that each recorded data message has two hours to reach the Storage Manager before the Storage Manager discards it and damages the recording file. With more disk space available (or fewer sessions to record), you can choose to increase this value. The maximum value is 365 days.

The other limitation with MSMQ is that when data backlogs, there is extra disk IOPS in the queue to read and write data messages. Normally, the Storage Manager receives and processes data from the network directly, without data messages ever being written to disk. Storing the data involves a single write operation to disk that appends the recorded session file. When data is backlogged, the disk IOPS is tripled: each message must be written to disk, read from disk, and written to file. As the Storage Manager is heavily IOPS bound, the processing rate of the Session Recording server drops until the backlog of messages is cleared. To mitigate the effects of this extra IOPS, adopt the following recommendations:

- Make sure that the disk on which MSMQ stores messages is different from the recording file storage folders. Even though IOPS bus traffic is tripled, the drop in the true processing rate is never as severe.
- Plan outages at off-peak times only. Depending on budget constraints, follow recognized approaches to building high availability servers. The approaches include the use of Uninterruptible Power Supply (UPS), dual NICs, redundant switches, and hot swappable memory and disks.

Design for spare capacity

The data rate of recorded session data is unlikely to be uniform, bursts and faults might occur, and the clearing of message backlogs is expensive in IOPS. For this reason, design each Session Recording server with plenty of spare capacity. Adding more servers or improving the specification of existing servers, as described in later sections, always gains you extra capacity. The general rule of thumb is to run each Session Recording server at a maximum of 50% of its total capacity. In the earlier example, if the server can process 5.0 Mbps, target the system to run only at 2.5 Mbps.

Backlogs and live playback

Live playback is when a reviewer opens a session recording for playback while the session is still active. During live playback, the responsible Session Recording agent switches to a streaming mode for that session. Recording data is sent immediately to the Storage Manager without internal buffering. Because the recording file is constantly updated, the player can continue to be fed with the latest data from the live session. However, data sent from the agent to the Storage Manager is through MSMQ, so the queuing rules described earlier apply. A problem can occur in this scenario. When MSMQ is backlogged, the new recorded data available for live playback is queued like all other data messages. The reviewer can still play the file, but viewing the latest live recorded data is delayed. If live playback is an important feature for reviewers, ensure a low probability of backlog. You can design spare capacity and fault tolerance into your deployment.

System scalability

Session Recording never reduces session performance and never stops sessions in response to recorded data backlogs. Maintaining the end-user experience and single-server scalability is paramount in the design of the Session Recording system. If the recording system becomes irreversibly overloaded, recorded session data is discarded. Recording ICA sessions has a low impact on the performance and scalability of VDAs. The size of the impact depends on the platform, the memory available, and the graphical nature of the sessions being recorded. With the following configuration, you can expect a single-server scalability impact of between 1% and 5%. In other words, if a server can host 100 users without Session Recording installed, it can host 95–99 users after installation:

- 64-bit server with 8 GB RAM running a multi-session OS VDA
- All sessions running Office productivity applications, such as Outlook and Excel
- The use of applications is active and sustained
- All sessions are recorded as configured by the Session Recording policies

With fewer sessions recorded or session activity less sustained and more sporadic, the impact is less. Often times, the scalability impact is negligible and user density per server remains the same. As mentioned earlier, the low impact results from the simple processing requirements of the Session Recording components on each VDA. Recorded data is extracted from the ICA session stack and sent as-is to the Session Recording server through MSMQ. There is no expensive encoding of data.

There is a minor overhead of using Session Recording even when no sessions are recorded. If you are not going to record any sessions from a particular server, you can disable recording on that server. Removing Session Recording is one way. A less invasive approach is to clear the **Enable session recording for this VDA machine** check box on the **Session Recording** tab in **Session Recording Agent Properties**. If session recording is required in future, reselect this check box.

Measuring throughput

You can measure the throughput of recorded session data from the sending VDA to the receiving Session Recording server. A simple and effective approach is to observe the size of recording files and the rate at which disk space on the Session Recording server is being consumed. The volume of data written to disk closely reflects the volume of network traffic being generated. The Windows Performance Monitor tool (perfmon.exe) has standard system counters that you can observe in addition to some counters provided by Session Recording. Counters can be used to measure throughput, and identify bottlenecks and system problems. The following table outlines some of the most useful performance counters.

Performance Object	Counter Name	Description
Citrix Session Recording Agent	Active Recording Count	The number of sessions that are currently being recorded on a particular VDA.
Citrix Session Recording Agent	Bytes read from the Session Recording Driver	The number of bytes read from the kernel components responsible for acquiring session data. Useful for determining how much data a single VDA generates for all sessions recorded on that server.
Citrix Session Recording Storage Manager	Active Recording Count	Similar to the Citrix Session Recording agent counter except for the Session Recording server. Indicates the total number of sessions currently being recorded for all servers.

Performance Object	Counter Name	Description
Citrix Session Recording Storage Manager	Message bytes/sec	The throughput of all recorded sessions. Can be used to determine the rate at which the Storage Manager is processing data. If MSMQ is backlogged with messages, the Storage Manager runs at full speed. This value can be used to indicate the maximum processing rate of the Storage Manager.
LogicalDisk	Disk Write Bytes/sec	Can be used to measure disk write-through performance, which is important in achieving high scalability for the Session Recording server. Performance of individual drives can also be observed.
MSMQ Queue	Bytes in Queue	Can be used to determine the amount of data backlogged in the CitrixSmAudData message queue. If this value increases over time, the rate of recorded data received from the network is greater than the rate at which the Storage Manager can process data. This counter is useful for observing the effect of data bursts and faults.
MSMQ Queue	Message in Queue	Similar to the Bytes in Queue counter but measures the number of messages.

Performance Object	Counter Name	Description
Network Interface	Bytes Total/sec	Can be used to measure on both sides of the link to observe how much data is generated when sessions are recorded. When measured on the Session Recording server, this counter indicates the rate at which incoming data is received. Contrasts with the Citrix Session Recording Storage Manager Message bytes/sec counter that measures the processing rate of data. If the network rate is greater than this value, messages build in the message queue.
Processor	% Processor Time	Worth monitoring even though CPU is unlikely to be a bottleneck.

Session Recording server hardware

You can increase the capacity of your deployment by carefully selecting the Session Recording server hardware. You have two choices: scaling up (by increasing the capacity of each server) or scaling out (by adding more servers). In making either of the choices, your aim is to increase scalability at a lowest cost.

Scaling up

When examining a single Session Recording server, consider the following best practices to ensure optimal performance for available budgets. The system depends on IOPS that can ensure a high throughput of recorded data from the network onto the disk. So it is important to invest in appropriate network and disk hardware. For a high-performance Session Recording server, a dual CPU or dual core CPU is recommended but little is gained from any higher specification. 64-bit processor architecture is recommended but an x86 processor type is also suitable. 4 GB of RAM is recommended but again there is little benefit from adding more.

Scaling out

Even with the best scaling up practices, there are limits to performance and scalability that can be reached with a single Session Recording server when recording many sessions. It might be necessary to add extra servers to meet the load. You can install more Session Recording servers on different machines to have the Session Recording servers work as a load balancing pool. In this type of deployment, the Session Recording servers share the storage and the database. To distribute the load, point the Session Recording agents to the load balancer that is responsible for the workload distribution.

Network capacity

A 100 Mbps network link is suitable for connecting a Session Recording server. A Gb Ethernet connection might improve performance, but does not result in 10 times greater performance than a 100 Mbps link. In practice, the gain in throughput is less.

Ensure that network switches used by Session Recording are not shared with third-party applications that might compete for available network bandwidth. Ideally, network switches are dedicated for use with the Session Recording server. If network congestion proves to be the bottleneck, a network upgrade is a relatively inexpensive way to increase the scalability of the system.

Storage

Investment in disk and storage hardware is the single most important factor in server scalability. The faster that data can be written to disk, the higher the performance of the overall system. When selecting a storage solution, take more note of the write performance than the read performance.

Store data on a RAID or a SAN.

Note:

Storing data on a NAS, based on file-based protocols such as SMB and NFS, might have performance and security implications. Use the latest version of the protocol in place to avoid security implications and perform scale testing to ensure proper performance.

For a local drive setup, aim for a disk controller with built-in cache memory. Caching allows the controller to use elevator sorting during write-back. It minimizes disk head movement and ensures that write operations are completed without waiting for the physical disk operation to complete. It can improve write performance significantly at a minimal extra cost. Caching does however raise the problem of data loss after a power failure. To ensure the integrity of data and the file system, consider a battery backup facility for the caching disk controller.

Consider using a suitable RAID storage solution. There are many RAID levels available depending on performance and redundancy requirements. The following table specifies each of the RAID levels and how applicable each standard is to Session Recording.

RAID Level	Type	Minimum Number of Disks	Description
RAID 0	Striped set without parity	2	Provides high performance but no redundancy. Loss of any disk destroys the array. RAID 0 is a low cost solution for storing recorded session files where the impact of data loss is low. Easy to scale up performance by adding more disks.
RAID 1	Mirrored set without parity	2	No performance gain over one disk, making it a relatively expensive solution. Use this solution only if a high level of redundancy is required.

RAID Level	Type	Minimum Number of Disks	Description
RAID 3	Striped set with dedicated parity	3	Provides high write performance with redundancy characteristics similar to RAID 5. RAID 3 is recommended for video production and live streaming applications. As Session Recording is this type of application, RAID 3 is most highly recommended but it is not common.
RAID 5	Striped set with distributed parity	3	Provides high read performance with redundancy but at the cost of slower write performance. RAID 5 is the most common for general purpose usages. But due to the slow write performance, RAID 5 is not recommended for Session Recording. RAID 3 can be deployed at a similar cost but with better write performance.

RAID Level	Type	Minimum Number of Disks	Description
RAID 10	Mirrored set and striped set	4	Provides performance characteristics of RAID 0 with redundancy benefits of RAID 1. An expensive solution that is not recommended for Session Recording.

RAID 0 and RAID 3 are the most recommended RAID levels. RAID 1 and RAID 5 are popular standards but are not recommended for Session Recording. RAID 10 does provide some performance benefits but is too expensive for the additional gain.

Decide on the type and specification of disk drives. IDE/ATA drives and external USB or Firewire drives are not suitable for use in Session Recording. The main choice is between SATA and SCSI. SATA drives provide reasonably high transfer rates at a reduced cost per MB compared with SCSI drives. However, SCSI drives provide better performance and are more common in server deployments. Server RAID solutions mostly support SCSI drives but some SATA RAID products are now available. When evaluating the specifications of disk drive products, consider the rotational speed of disk and other performance characteristics.

Because the recording of thousands of sessions per day can consume significant amounts of disk space, you must choose between overall capacity and performance. From the earlier example, recording 5,000 Outlook sessions over an 8-hour work day consumes about 100 GB of storage space. To store 10 days' worth of recordings (that is, 50,000 recorded session files), you need 1,000 GB (1 TB). This pressure on disk space can be eased by shortening the retention period before archiving or deleting old recordings. If 1 TB of disk space is available, a seven-day retention period is reasonable, ensuring disk space usage remains around 700 GB, with 300 GB remaining as a buffer for busy days. In Session Recording, the archiving and deleting of files is supported with the ICLDB utility. It has a minimum retention period of two days. You can schedule a background task to run once a day at some off-peak time. For more information about the **ICLDB** commands and archiving, see [Manage your database records](#).

The alternative to using local drive and controllers is to use a SAN storage solution based on block-level disk access. To the Session Recording server, the disk array appears as a local drive. SANs are more expensive to set up, but as the disk array is shared, SANs do have the advantage of simplified and centralized management. There are two main types of SAN: Fibre Channel and iSCSI. iSCSI is essentially SCSI over TCP/IP and is gaining popularity over Fibre Channel since the introduction of Gb Ethernet.

Database scalability

The volume of data sent to the Session Recording database is small because the database stores only metadata about the recorded sessions. The files of the recorded sessions themselves are written to a separate disk. Typically, each recorded session requires only about 1 KB of space in the database, unless the Session Recording Event API is used to insert searchable events to the session.

The Express Editions of Microsoft SQL Server 2019, Microsoft SQL Server 2017, Microsoft SQL Server 2016, Microsoft SQL Server 2014, Microsoft SQL Server 2012, and Microsoft SQL Server 2008 R2 impose a database size limitation of 10 GB. At 1 KB per recording session, the database can catalog about 4,000,000 sessions. Other editions of Microsoft SQL Server have no database size restrictions and are limited only by available disk space. As the number of sessions in the database increases, performance of the database and speed of searches diminishes only negligibly.

If you are not making customizations through the [Session Recording Event API](#), each recorded session generates four database transactions: two when recording starts, one when the user logs on to the session being recorded, and one when recording ends. If you use the Session Recording Event API to customize sessions, each searchable event recorded generates one transaction. Because even the most basic database deployment can handle hundreds of transactions per second, the processing load on the database is unlikely to be stressed. The impact is light enough that the Session Recording database can run on the same SQL Server as other databases, including the Citrix Virtual Apps and Desktops data store database.

If your Session Recording deployment requires many millions of recorded sessions to be cataloged in the database, follow Microsoft guidelines for SQL Server scalability.

Install, upgrade, and uninstall

December 11, 2024

Note:

To configure server high availability through load balancing, see [Configure load balancing in an existing deployment](#) and [Deploy and load balance Session Recording in Azure](#).

To learn more about how to quickly set up and configure Citrix Session Recording and Citrix Session Recording service, see the Citrix Tech Zone article [POC Guide: Citrix Session Recording](#).

You can install the Session Recording server and agent on an Azure AD joined machine and enable Azure AD support for them. Later when you configure various policies and playback permissions from the cloud, you can specify Azure AD users and groups who launch sessions from Azure AD joined machines. The **Enable Azure AD support** option is **not** available on the GUI when you

install the Session Recording server using the Citrix Virtual Apps and Desktops installer.

This article contains the following sections:

[Installation checklist](#)

Use Citrix scripts to install the Windows roles and features prerequisites

[Install Session Recording using the Citrix Virtual Apps and Desktops installer](#)

[Automate installation](#)

Install the Session Recording database on cloud SQL database services

[Upgrade Session Recording](#)

[Uninstall Session Recording](#)

[Integrate with Citrix Analytics for Security](#)

Installation checklist

Before you start the installation, complete this list:

☒	Step
	<p>Select the machines on which you want to install each Session Recording component. Ensure that each computer meets the hardware and software requirements for the components to be installed on it.</p> <p>Use your Citrix account credentials to access the Citrix Virtual Apps and Desktops download page and download the product ISO file. Unzip the ISO file or burn a DVD of it.</p> <p>To use the TLS protocol for communication between the Session Recording components, install the correct certificates in your environment.</p> <p>Install any hotfixes required for the Session Recording components. The hotfixes are available from the Citrix Support.</p>

☒	Step
	Configure the Citrix Director to create and activate the Session Recording policies. For more information, see Configure Director to use the Session Recording Server .

Note:

- We recommend that you divide the published applications into separate Delivery Groups based on your recording policies. Session sharing for published applications can conflict with the active policy if the applications are in the same Delivery Group. Session Recording matches the active policy with the first published application that a user opens. Starting with the 7.18 release, you can use the dynamic session recording feature to start or stop recording sessions at any time during the sessions. This feature can help to mitigate the conflict issue with the active policy. For more information, see [Dynamic session recording](#).
- If you are planning to use Machine Creation Services (MCS) or Provisioning Services, prepare a unique **QMID**. Failure to comply can cause recording data losses.
- SQL Server requires TCP/IP, running SQL Server Browser service, and enabled Windows Authentication.
- To use HTTPS, configure server certificates for TLS/HTTPS.
- Ensure that users under **Local Users and Groups > Groups > Users** have write permission to the `C:\windows\Temp` folder.

(Required only for msi installation) Use Citrix scripts to install the Windows roles and features prerequisites

For Session Recording to work properly, use the following Citrix scripts to install the necessary Windows roles and features prerequisites before installing Session Recording:

- `InstallPrereqsforSessionRecordingAdministration.ps1`

```

1 <#
2 .Synopsis
3     Installs Prereqs for Session Recording Administration
4 .Description
5     Supports Windows Server 2025, Windows Server 2022, Windows
6     Server 2019.
7     Install below windows feature on this machine:
8     -Application Development
9     -Security - Windows Authentication
    -Management Tools - IIS 6 Management Compatibility

```

```
10     IIS 6 Metabase Compatibility
11     IIS 6 WMI Compatibility
12     IIS 6 Scripting Tools
13     IIS 6 Management Console
14     -Microsoft Message Queuing (MSMQ), with Active Directory
        integration disabled, and MSMQ HTTP support enabled.
15 #>
16 function AddFeatures($featurename)
17 {
18
19     try
20     {
21
22         $feature=Get-WindowsFeature | ? {
23     $_.DisplayName -eq $featurename -or $_.Name -eq $featurename }
24
25         Add-WindowsFeature $feature
26     }
27
28     catch
29     {
30
31         Write-Host "Addition of Windows feature $featurename
32             failed"
33         Exit 1
34     }
35
36     Write-Host "Addition of Windows feature $featurename
37         succeeded"
38 }
39
40 $system= gwmi win32_operatingSystem | select name
41
42 if (-not (($system -Like '*Microsoft Windows Server 2025*') -or (
43     $system -Like '*Microsoft Windows Server 2022*') -or ($system
44     -Like '*Microsoft Windows Server 2019*'))
45 {
46
47     Write-Host("This is not a supported server platform.
48         Installation aborted.")
49     Exit
50 }
51
52 # Start to install Windows feature
53 Import-Module ServerManager
54
55 AddFeatures('Web-Asp-Net45') #ASP.NET 4.5
56 AddFeatures('Web-Mgmt-Console') #IIS Management Console
57 AddFeatures('Web-Windows-Auth') # Windows Authentication
58 AddFeatures('Web-Metabase') #IIS 6 Metabase Compatibility
59 AddFeatures('Web-WMI') #IIS 6 WMI Compatibility
```

```
57 AddFeatures('Web-Lgcy-Scripting')#IIS 6 Scripting Tools
58 if (($system -Like '*Microsoft Windows Server 2022*') -or (
    $system -Like '*Microsoft Windows Server 2019*'))
59 {
60
61     AddFeatures('Web-Lgcy-Mgmt-Console') #IIS 6 Management
        Console
62 }
63
64
65 AddFeatures('MSMQ-HTTP-Support') #MSMQ HTTP Support
66 AddFeatures('web-websockets') #IIS Web Sockets
67 AddFeatures('NET-WCF-HTTP-Activation45') #http activate
```

- InstallPrereqsforSessionRecordingAgent.ps1

```
1 <#
2 .Synopsis
3     Installs Prereqs for Session Recording Agent
4 .Description
5     Supports Windows Server 2025, Windows Server 2022, Windows
        Server 2019, windows 11, and Windows 10.
6     Install below windows feature on this machine:
7     -Microsoft Message Queuing (MSMQ), with Active Directory
        integration disabled, and MSMQ HTTP support enabled.
8 #>
9 function AddFeatures($featurename)
10 {
11
12     try
13     {
14
15         $feature=Get-WindowsFeature | ? {
16 $_.DisplayName -eq $featurename -or $_.Name -eq $featurename }
17
18         Add-WindowsFeature $feature
19     }
20
21     catch
22     {
23
24         Write-Host "Addition of Windows feature $featurename
                failed"
25         Exit 1
26     }
27
28     Write-Host "Addition of Windows feature $featurename
                succeeded"
29 }
30
31
32 # Start to install Windows feature
33 $system= gwmi win32_operatingSystem | select name
```

```
34
35 if (-not (($system -Like '*Microsoft Windows Server 2025*') -or (
    $system -Like '*Microsoft Windows Server 2022*') -or ($system
    -Like '*Microsoft Windows Server 2019*') -or ($system -Like '*
    Microsoft Windows 11*') -or ($system -Like '*Microsoft Windows
    10*')))
36 {
37
38     Write-Host("This is not a supported platform. Installation
        aborted.")
39     Exit
40 }
41
42
43 if ($system -Like '*Microsoft Windows Server*')
44 {
45
46     Import-Module ServerManager
47     AddFeatures('MSMQ') #Message Queuing
48     AddFeatures('MSMQ-HTTP-Support')#MSMQ HTTP Support
49 }
50
51 else
52 {
53
54     try
55     {
56
57         dism /online /enable-feature /featurename:MSMQ-HTTP /all
58     }
59
60     catch
61     {
62
63         Write-Host "Addition of Windows feature MSMQ HTTP Support
            failed"
64         Exit 1
65     }
66
67     write-Host "Addition of Windows feature MSMQ HTTP Support
        succeeded"
68 }
```

To install the Windows roles and features prerequisites, complete the following steps:

1. On the machine where you plan to install the Session Recording administration components:
 - a) Make sure that the execution policy is set to **RemoteSigned** or **Unrestricted** in PowerShell.

```
1 Set-ExecutionPolicy RemoteSigned
```
 - b) Start a command prompt as an administrator and run the `powershell.exe -file`

`InstallPrereqsforSessionRecordingAdministration.ps1` command.

The script displays the features that are successfully added and then stops.

- c) After the script runs, make sure that the execution policy is set to a proper value based on your company policy.

2. On the machine where you plan to install the Session Recording agent component:

- a) Make sure that the execution policy is set to **RemoteSigned** or **Unrestricted** in PowerShell.

```
1 Set-ExecutionPolicy RemoteSigned
```

- b) Start a command prompt as an administrator and run the `powershell.exe -file InstallPrereqsforSessionRecordingAgent.ps1` command.

The script displays the features that are successfully added and then stops.

- c) After the script runs, make sure that the execution policy is set to a proper value based on company policy.

Install Session Recording using the Citrix Virtual Apps and Desktops installer

Citrix Session Recording comprises the following components:

- Session Recording Administration (including the Session Recording database, Session Recording server, and Session Recording policy console)
- Session Recording agent
- Session Recording player
- Session Recording web player

While installing all the components on a single server is acceptable for a **proof of concept**, we recommend installing them on separate servers as follows:

- Install the Microsoft SQL Server on Machine A.
- Install the Session Recording server, Session Recording administrator logging, and Session Recording database on Machine B.

Note:

The Session Recording database isn't an actual database. It is a component that creates and configures the required databases in the Microsoft SQL Server instance during installation.

Installing the Session Recording server lets you install the Session Recording web player automatically.

- Install the Session Recording policy console on Machine C.
- Install the Session Recording player on either Machine C or Machine D.
- Install the Session Recording agent on the VDA.

[Install the Session Recording Administration components](#)

[Install the Session Recording agent](#)

[Install the Session Recording player](#)

Install the Session Recording Administration components

Note:

Before installing the Session Recording Administration components on Windows Server where TLS 1.0 is disabled and the version of the .NET Framework is earlier than 4.6, complete the following steps:

1. Install Microsoft OLE DB Driver for SQL Server.
2. Under the `HKEY_LOCAL_MACHINE\SOFTWARE\Microsoft\ .NETFramework\v4.0.30319` registry key, add the `SchUseStrongCrypto` DWORD (32-bit) value and set the value data to 1.
3. Restart Windows Server.

For more information, see [Transport Layer Security \(TLS\) best practices with the .NET Framework](#).

The Session Recording Administration components include the Session Recording database, Session Recording server, and Session Recording policy console. You can choose the component to install on a server.

Step 1: Download the product software and launch the wizard

1. Use your Citrix account credentials to access the Citrix Virtual Apps and Desktops download page and download the product ISO file. Unzip the ISO file or burn a DVD of it.
2. Use a local administrator account to log on to the machine where you are installing the Session Recording Administration components. Insert the DVD in the drive or mount the ISO file. If the installer does not launch automatically, double-click the **AutoSelect** application or the mounted drive.

The installation wizard launches.

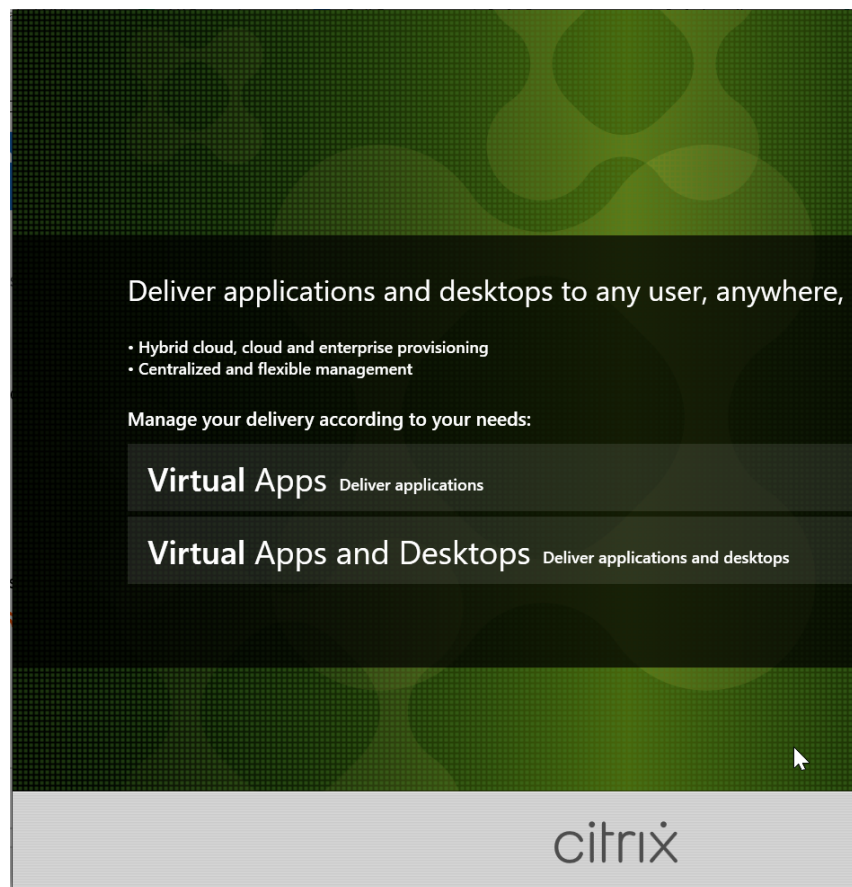

Step 2: Choose which product to install

Click **Start** next to the product to install **Citrix Virtual Apps** or **Citrix Virtual Desktops**.

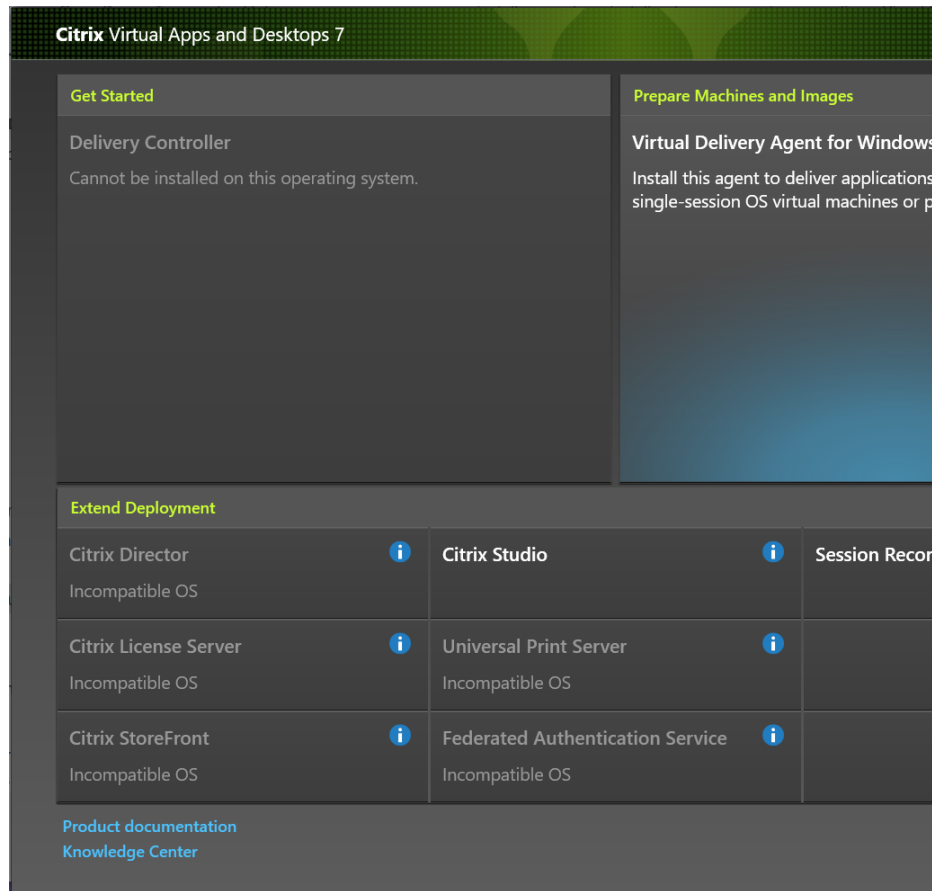

Step 3: Select Session Recording

Select the **Session Recording** entry.

The screenshot shows the 'Citrix Virtual Apps and Desktops 7' interface. On the left, a navigation pane under 'Licensing Agreement' lists 'Core Components', 'Summary', 'Install', and 'Finish'. The main content area is titled 'Software License Agreement' and contains the following text:

Last Revised: August 19, 2020

CITRIX LICENSE AGREEMENT

This is a legal agreement ("AGREEMENT") between you, the end user, and Citrix, the providing Citrix entity (the applicable "CITRIX"). This AGREEMENT includes the Citrix Services Security Exhibit and any other documents located at the location of receipt of the Citrix product (hereinafter "MAINTENANCE") determined at www.citrix.com/buy/licensing/citrix-provisioning. BY USING THE PRODUCT, YOU AGREE TO THIS AGREEMENT. IF YOU DO NOT AGREE TO THIS AGREEMENT, DO NOT INSTALL AND/OR USE THE PRODUCT OR ANY ORDER OR ANY OTHER DOCUMENT SUBMITTED BY YOU TO THIRD PARTY PRODUCTS SOLD BY CITRIX, WHICH MAY BE SUBJECT TO THE TERMS AND CONDITIONS CONTAINED IN THIS AGREEMENT.

1. **PRODUCT LICENSES.**

a. **End User Licenses.** Citrix hereby grants you a license to use the Citrix product on a non-exclusive, non-transferable, non-assignable, and non-sublicensable basis. This license is subject to the terms and conditions of the Citrix End User License Agreement (EULA) located at www.citrix.com/buy/licensing/citrix-provisioning.

I have heard, understand, and accept the terms and conditions of the license agreement checked to be able to continue installation.

I do not accept the terms of the license agreement.

Step 4: Read and accept the license agreement

On the **Software License Agreement** page, read the license agreement, accept it, and then click **Next**.

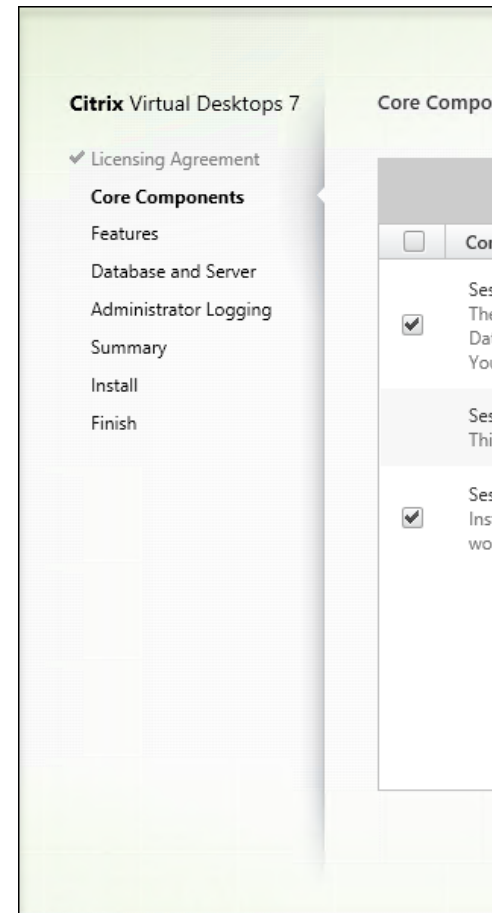

Step 5: Select the components to install and the installation location

On the **Core Components** page:

- **Location:** By default, components are installed in C:\Program Files\Citrix. The default location works for most deployments. You can specify a custom installation location.
- **Component:** By default, all the check boxes next to the components that can be installed are selected. The installer knows whether it is running on a single-session OS or a multi-session OS. It allows the Session Recording Administration components to be installed on a multi-session OS only. It allows the Session Recording agent to be installed only on a machine that has a VDA installed. If you install the Session Recording agent on a machine that has no VDA installed in advance, the **Session Recording Agent** option is unavailable.

Select **Session Recording Administration** and click **Next**.

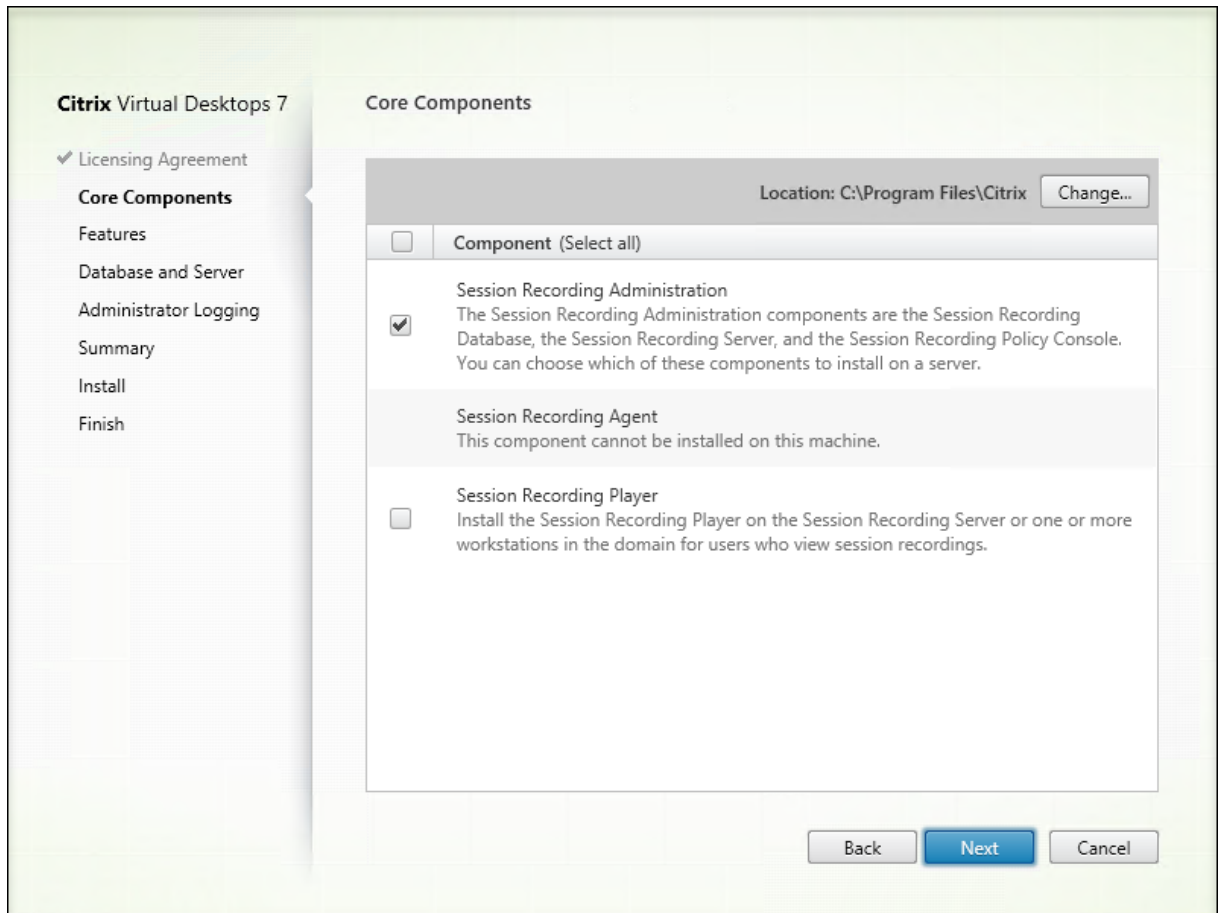

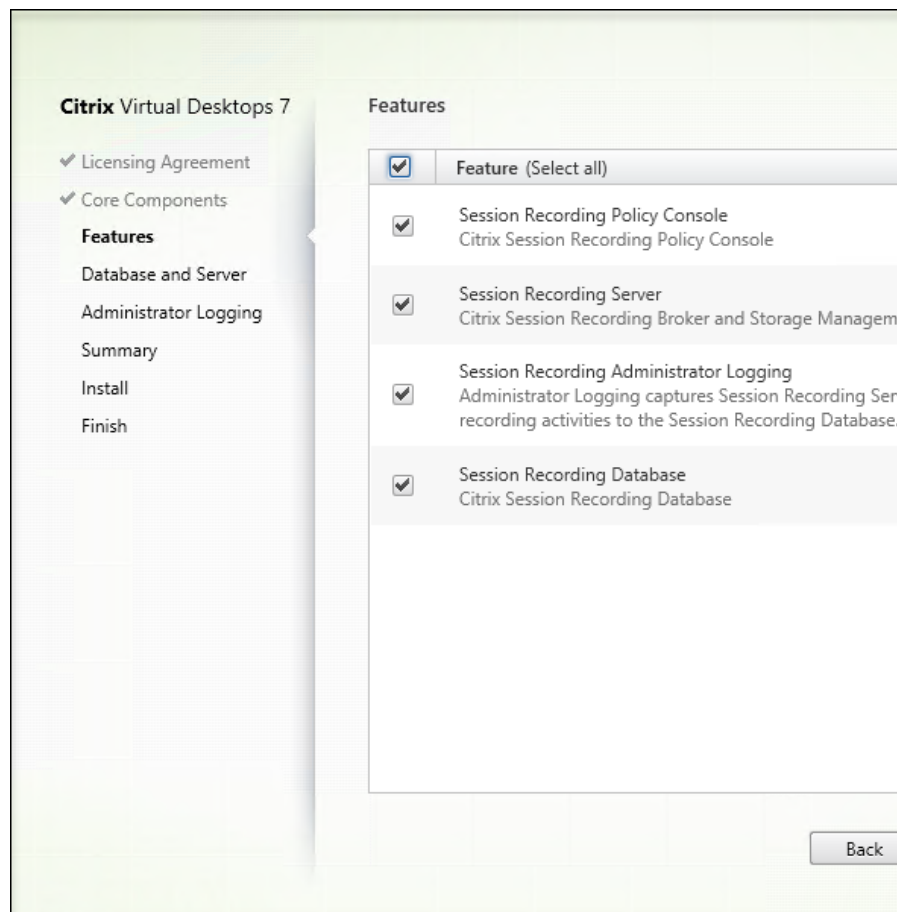

Step 6: Select the features to install

On the **Features** page:

- By default, all the check boxes next to the features that can be installed are selected. Installing all these features on a single server is fine for a proof of concept. For a large production environment, install the Session Recording policy console on a separate server. Install the Session Recording server, administrator logging, and database on another separate server.
- The Session Recording administrator logging is an optional subfeature of the Session Recording server. Select the Session Recording server before you can select the Session Recording administrator logging. The Session Recording database is a mandatory subfeature of the Session Recording server. When the Session Recording server is selected for installation, the Session Recording database is also selected automatically and cannot be unselected.

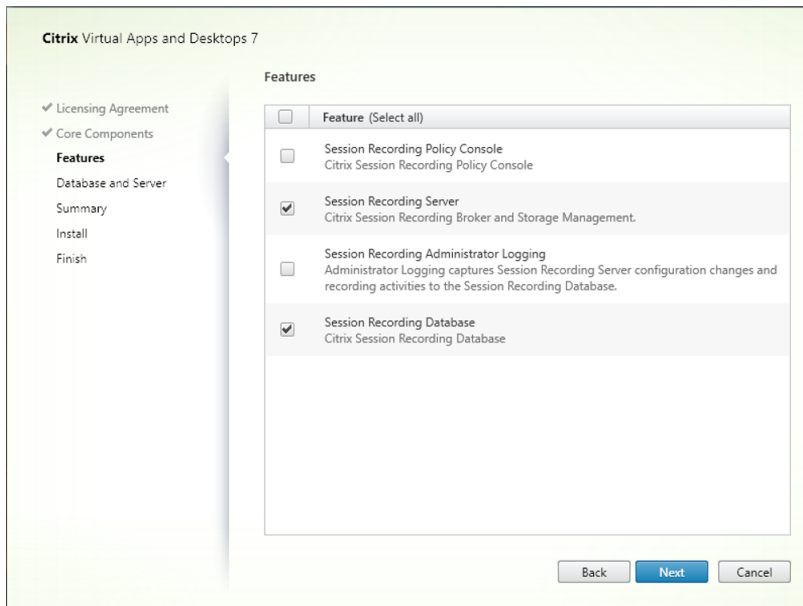
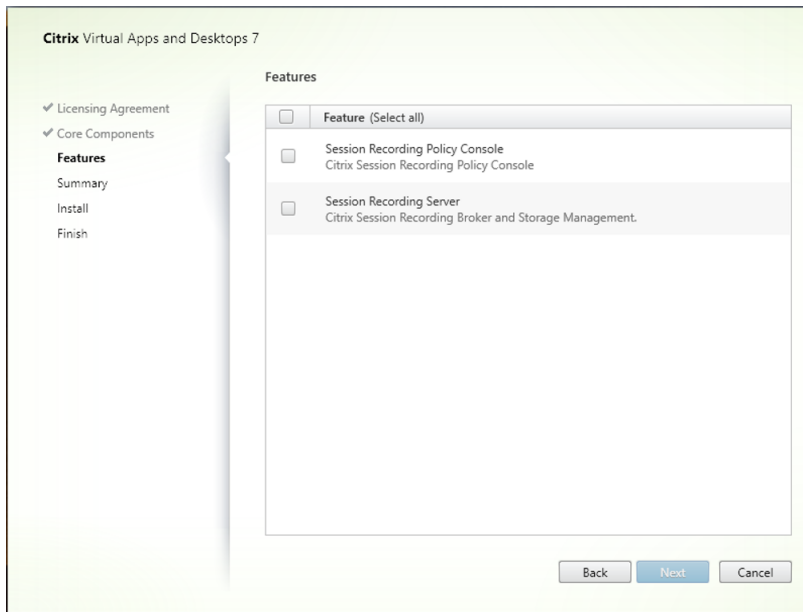

- If you select the Session Recording server, the Session Recording web player is installed too.
- To add features on the same server after you select and install features on it, you can only use the msi package. You cannot run the installer again.
- **Session Recording server**

The Session Recording server is a server that hosts:

- The Broker. An IIS 6.0+ hosted Web application that serves the following purposes:
 - * Handling search queries and file download requests from the Session Recording player and web player.
 - * Handling policy administration requests from the Session Recording policy console.

- * Evaluating recording policies for each Citrix Virtual Apps and Desktops or Citrix DaaS (formerly Citrix Virtual Apps and Desktops service) session.
- The Storage Manager. A Windows service that manages the recorded session files received from each Session Recording-enabled VDA.
- Administrator Logging. An optional subcomponent installed with the Session Recording server to log the administration activities. All the logging data is stored in a separate SQL Server database named **CitrixSessionRecordingLogging** by default. You can customize the database name.

- **Session Recording database**

- The Session Recording database isn't an actual database. It is a component that creates and configures the required databases in the Microsoft SQL Server instance during installation. Session Recording supports three solutions for database high availability based on Microsoft SQL Server. For more information, see [Database high availability](#).
- You can install the Session Recording database on the following cloud SQL database services:
 - * Azure SQL Database
 - * Azure SQL Managed Instance
 - * SQL Server on Azure Virtual Machines (VMs)
 - * AWS RDS
 - * Google Cloud SQL Server

- **Session Recording admin logging**

We recommend that you install the Session Recording administrator logging together with the Session Recording server at the same time. If you don't want the administrator logging feature to be enabled, you can disable it on a later page. However, if you choose not to install this feature at the beginning but want to add it later, you can only manually add it by using Session-RecordingAdministrationx64.msi.

- **Session Recording policy console**

You can use the Session Recording policy console to configure [policies](#).

Step 6.1: Install the Session Recording server, database, and administrator logging As described earlier, the Session Recording database is a mandatory subfeature of the Session Recording server and we recommend that you install the Session Recording administrator logging together with the Session Recording server at the same time. Therefore, this section walks you through installing the three components on the same machine.

1. On the **Features** page, select **Session Recording Server** and **Session Recording Administrator Logging**. With **Session Recording Server** selected, **Session Recording Database** is also selected automatically. Click **Next**.

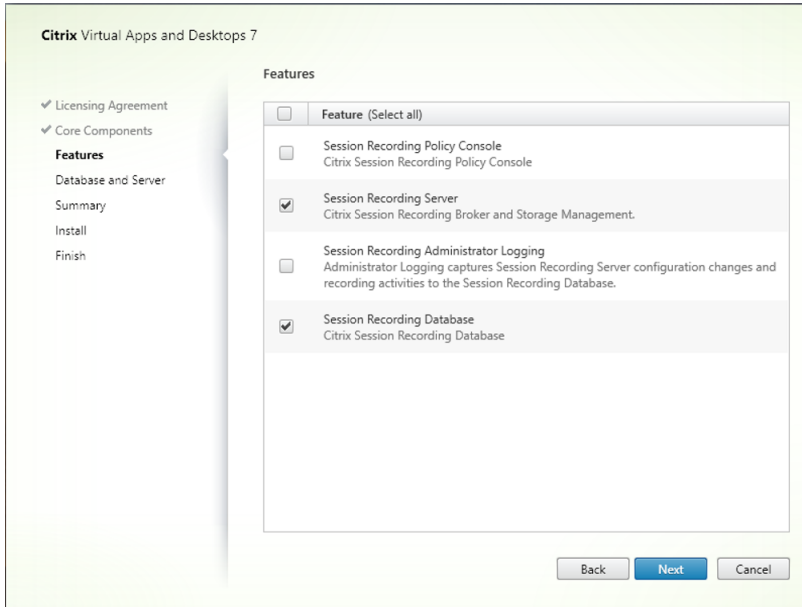

2. On the **Database and Server Configuration** page, specify the instance name and database name of the Session Recording database, enable **SQL Server authentication** as needed, and click **Next**.

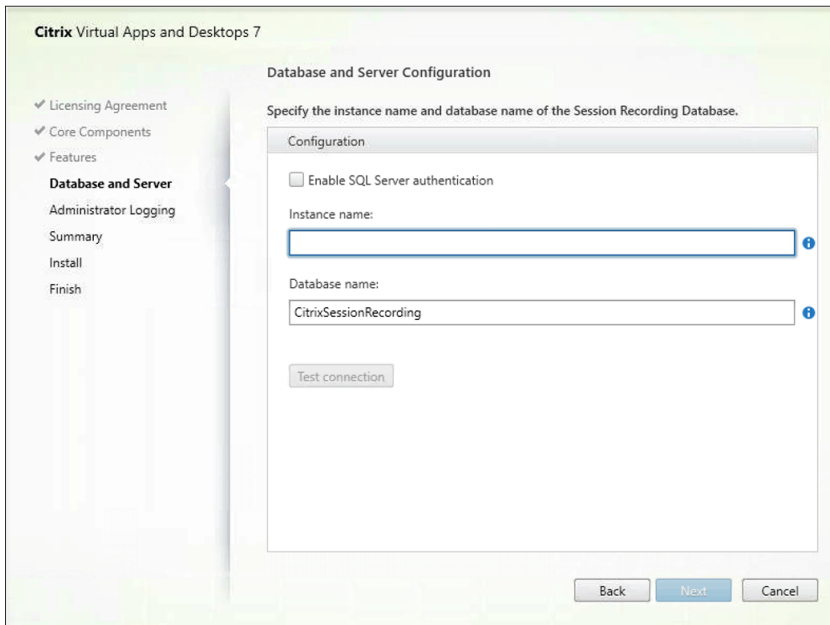

On the **Database and Server Configuration** page:

- **Enable SQL Server authentication:** This option lets you connect to the Session Recording database using SQL Server authentication.

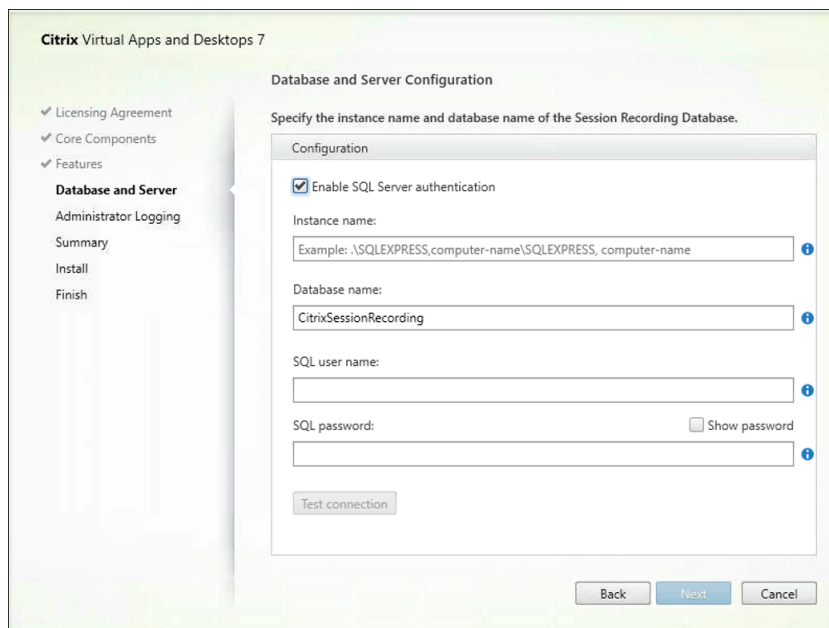

- **Instance name:** If the database instance isn't a named instance, you can use only the computer name of the SQL Server. If you have named the instance during the instance setup, use computer-name\instance-name as the database instance name. To determine the server instance name that you are using, run **select @@servername** on the SQL Server. The return value is the exact database instance name. If your SQL server is configured to be listening on a custom port other than the default port 1433, set the custom listener port by appending a comma to the instance name. For example, type **DXSBC-SRD-1,2433** in the **Instance name** text box, where 2433, following the comma, denotes the custom listener port.
- **Database name:** Type a custom database name in the **Database name** text box or use the default database name preset in the text box. Click **Test connection** to test the connectivity to the SQL Server instance and the validity of the database name.

Note:

The Session Recording server default installation uses HTTPS/TLS to secure communications. If TLS is not configured in the default Internet Information Services (IIS) site of the Session Recording server, use HTTP. To do so, cancel the selection of SSL in the IIS Management Console by navigating to the Session Recording Broker site, opening the SSL settings, and clearing the **Require SSL** check box.

Important:

A custom database name must contain only A-Z, a-z, 0–9, and underscores, and cannot exceed 123 characters.

You must have the **securityadmin** and **dbcreator** server role permissions of the SQL

Server instance. If you do not have the permissions, you can:

- Ask the database administrator to assign the permissions for the installation. After the installation completes, the **securityadmin** and **dbcreator** server role permissions are no longer necessary and can be safely removed.
- Or, use the SessionRecordingAdministrationx64.msi package under **\x64\Session Recording** on the Citrix Virtual Apps and Desktops ISO. During the msi installation, a dialog box prompts for the credentials of a database administrator with the **securityadmin** and **dbcreator** server role permissions. Type the correct credentials and then click **OK** to continue the installation.

The installation creates the Session Recording database and adds the machine account of the Session Recording server as **db_owner**.

3. On the **Administration Logging Configuration** page, specify configurations for the administration logging feature.

The screenshot shows the 'Administrator Logging Configuration' dialog box. The left sidebar lists navigation options: Citrix Virtual Desktops 7, Licensing Agreement, Core Components, Features, Database and Server, Administrator Logging (selected), Summary, Install, and Finish. The main area is titled 'Administrator Logging Configuration' and contains a 'Specify Session Recording logging configuration' section. This section includes a 'Configuration' box with two text inputs: 'The Administrator Logging database is installed on the SQL Server instance:' (value: YVDFX-SRD-1) and 'Administrator Logging database name:' (value: CitrixSessionRecordingLogging). Below these is a 'Test connection...' button. At the bottom of the configuration box are two checked checkboxes: 'Enable Administrator Logging' (with subtext 'This option enables the Session Recording Administrator Logging service.') and 'Enable mandatory blocking' (with subtext 'This option blocks policy and server property changes if logging fails.'). At the very bottom of the dialog are 'Back', 'Next', and 'Cancel' buttons.

On the **Administration Logging Configuration** page:

- **The Administration Logging database is installed on the SQL Server instance:** This text box is not editable. The SQL Server instance name of the Administration Logging database is automatically grabbed from the instance name that you typed on the **Database and Server Configuration** page.
- **Administrator Logging database name:** To install the Session Recording administrator logging feature, type a custom database name for the administrator logging database in this text box or use the default database name **CitrixSessionRecordingLogging** that is preset in the text box.

Note:

The administrator logging database name must be different from the Session Recording database name that is set in the **Database name** text box on the previous **Database and Server Configuration** page.

- After typing the administrator logging database name, click **Test connection** to test the connectivity to the administrator logging database.
- **Enable Administration Logging:** By default, the administration logging feature is enabled. You can disable it by clearing the check box.
- **Enable mandatory blocking:** By default, mandatory blocking is enabled. The normal features might be blocked if logging fails. You can disable mandatory blocking by clearing the check box.

Click **Next** to continue the installation.

4. Review the prerequisites and confirm the installation.

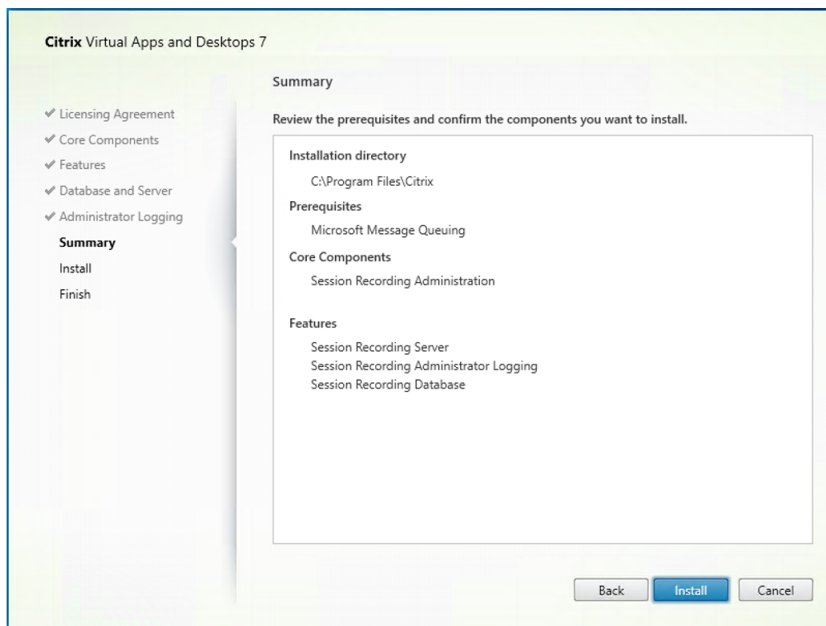

The **Summary** page shows your installation choices. You can click **Back** to return to the earlier wizard pages and make changes, or click **Install** to start the installation.

5. Complete the installation.

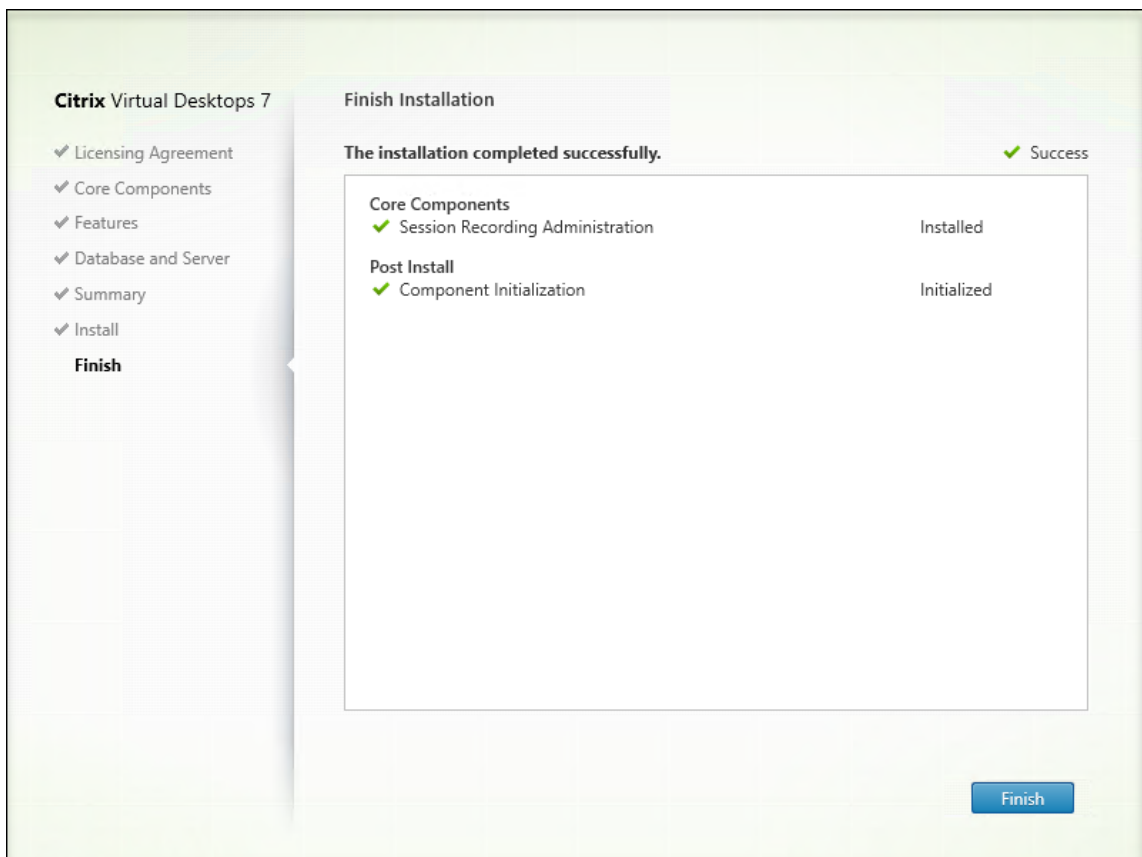

The **Finish Installation** page shows green check marks for all the prerequisites and components that have been installed and initialized successfully.

Click **Finish** to complete the installation of the Session Recording server, database, and administrator logging.

Step 6.2: Install the Session Recording policy console To install the Session Recording policy console, complete the following steps:

1. On the **Features** page, select **Session Recording Policy Console** and click **Next**.

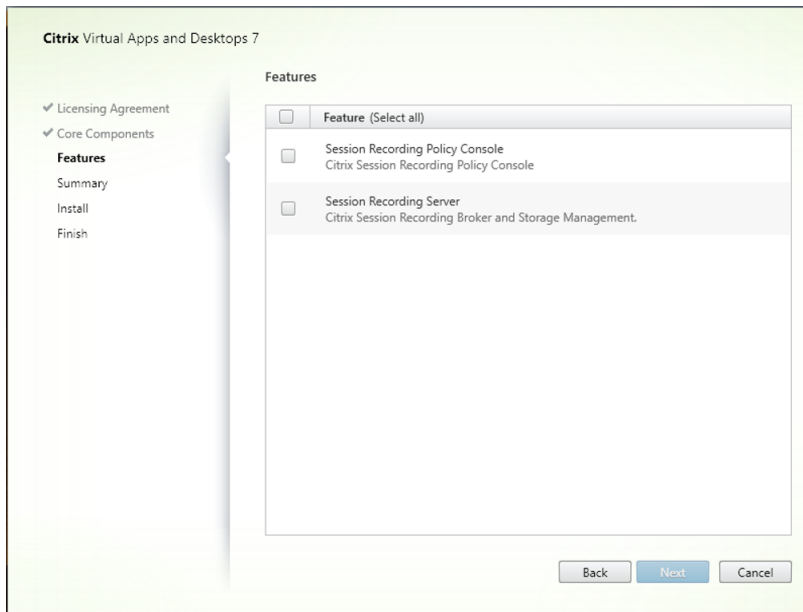

2. Review the prerequisites and confirm the installation.

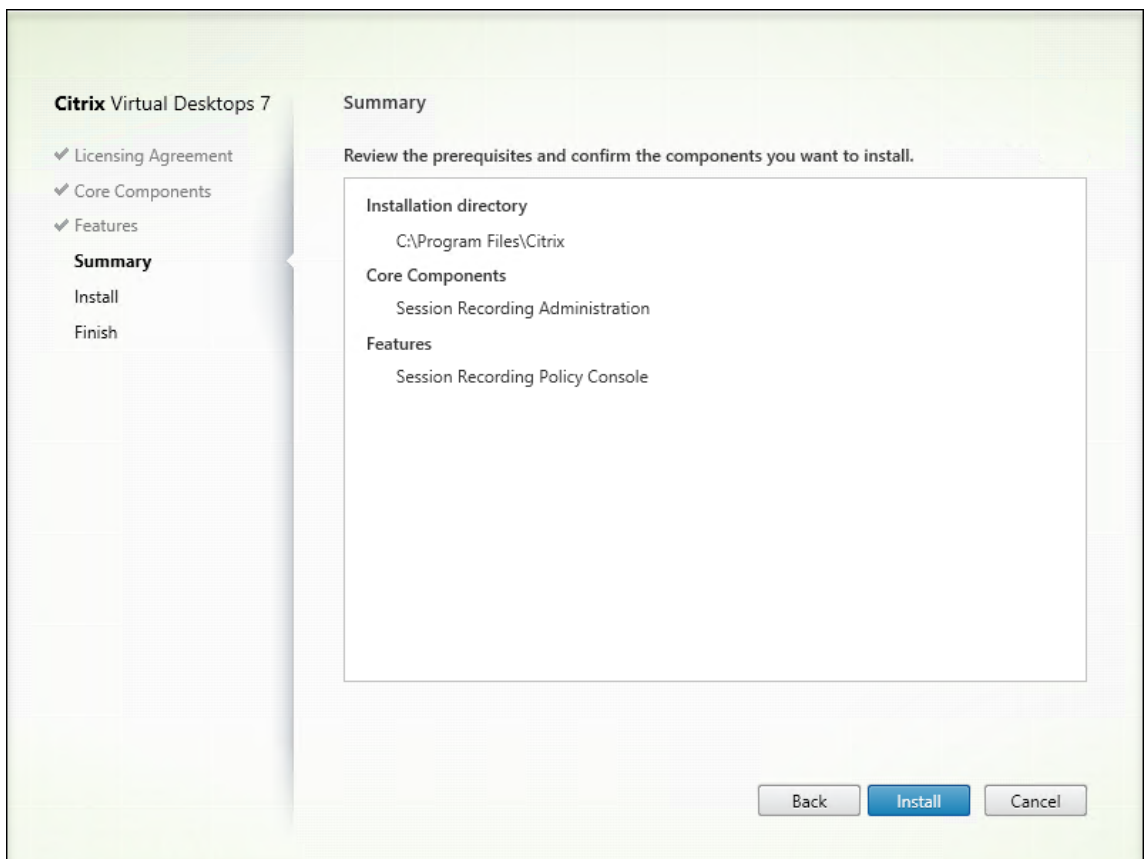

The **Summary** page shows your installation choices. You can click **Back** to return to the earlier wizard pages and make changes, or click **Install** to start the installation.

3. Complete the installation.

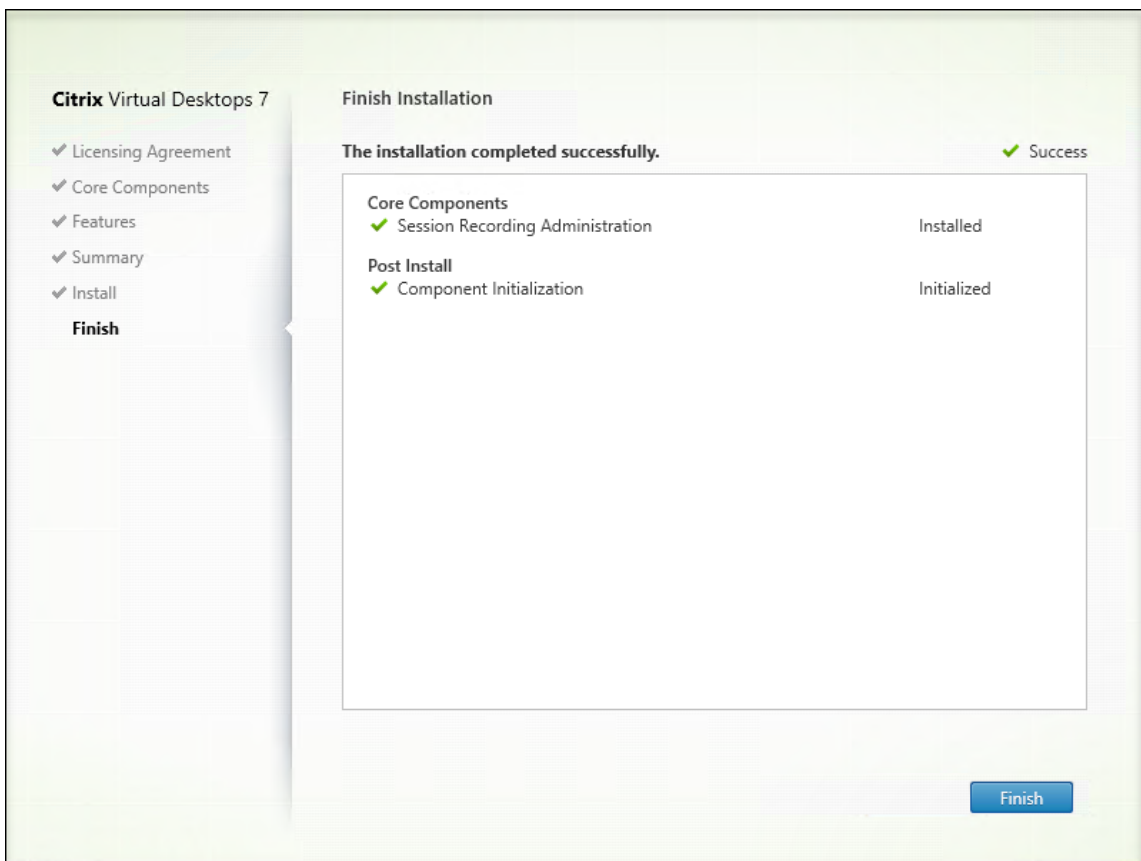

The **Finish Installation** page shows green check marks for all the prerequisites and components that have been installed and initialized successfully.

Click **Finish** to complete your installation of the Session Recording policy console.

Step 7: Install Broker_PowerShellSnapIn_x64.msi

Important:

To use the Session Recording policy console, install the Broker PowerShell Snap-in (Broker_PowerShellSnapIn_x64.msi) manually. Locate the snap-in on the Citrix Virtual Apps and Desktops ISO (\x64\Citrix Desktop Delivery Controller) and follow the instructions for installing it. Failure to comply can cause an error.

Install the Session Recording agent

The Session Recording agent is a component installed on each VDA for multi-session OS or single-session OS to enable recording. It is responsible for recording session data.

Step 1: Download the product software and launch the wizard Use a local administrator account to log on to the machine where you are installing the Session Recording agent. Insert the DVD in the

drive or mount the ISO file. If the installer does not launch automatically, double-click the **AutoSelect** application or the mounted drive.

The installation wizard launches.

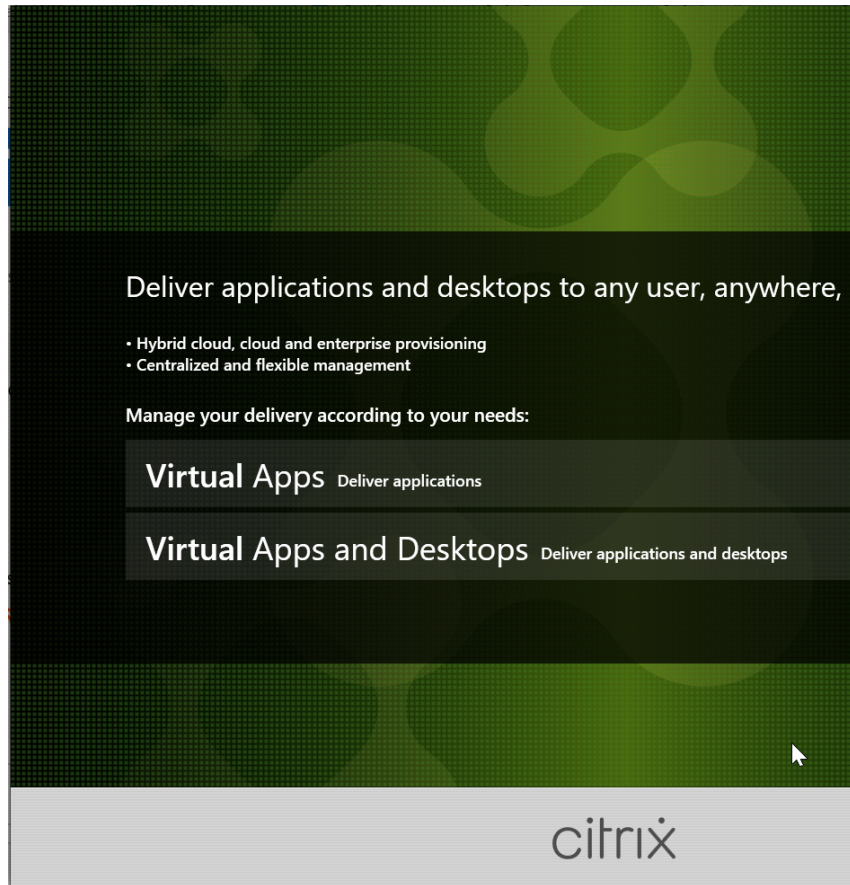

Step 2: Choose which product to install

Click **Start** next to the product to install **Citrix Virtual Apps** or **Citrix Virtual Desktops**.

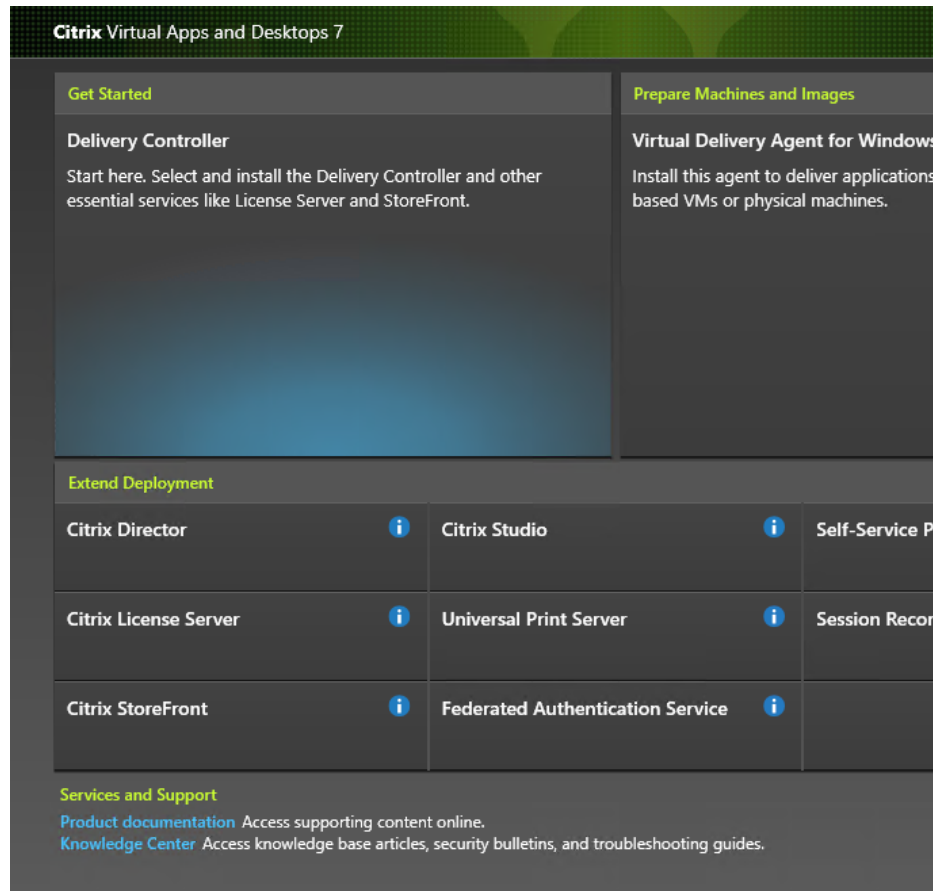

Step 3: Select Session Recording

Select the **Session Recording** entry.

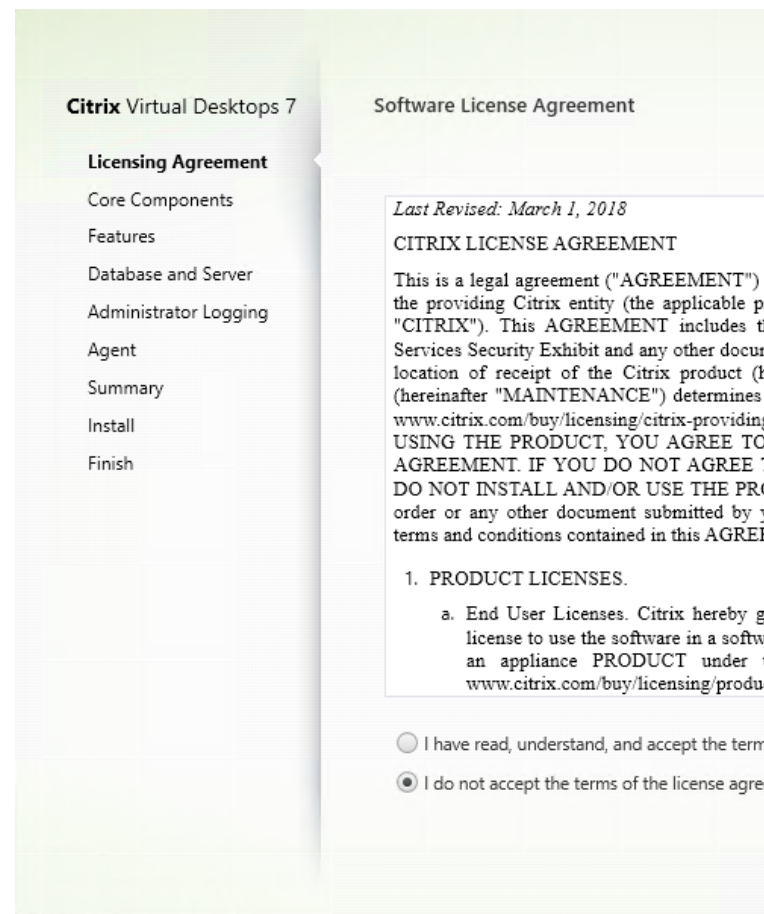

Step 4: Read and accept the license agreement

On the **Software License Agreement** page, read the license agreement, accept it, and then click **Next**

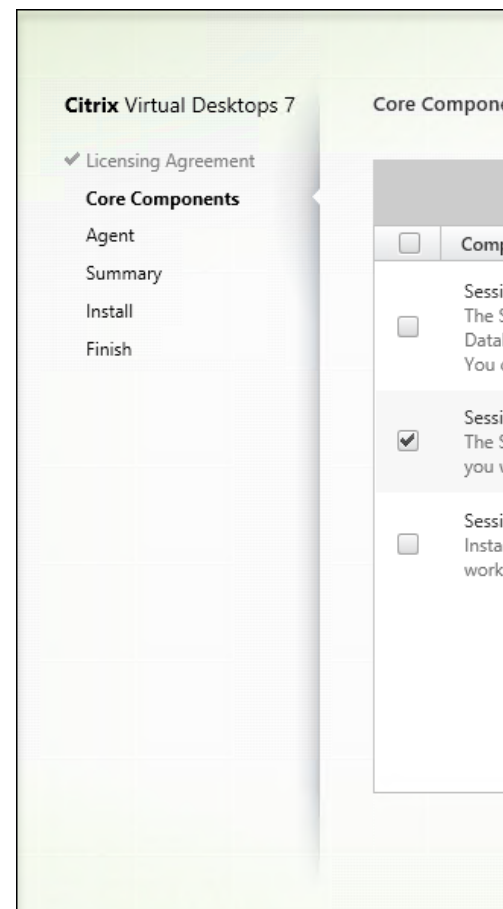

Step 5: Select the component to install and the installation location

Select **Session Recording Agent** and click **Next**.

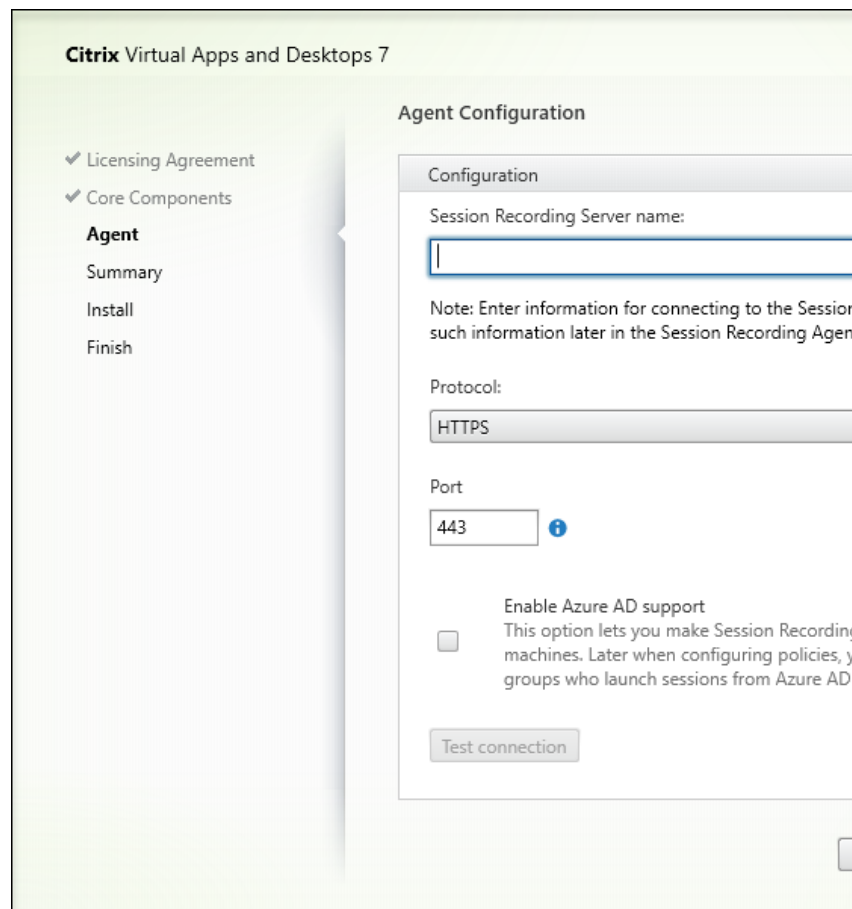

Step 6: Specify the agent configuration

On the **Agent Configuration** page, complete the following settings:

- Type the computer name of the machine where you installed the Session Recording server and the protocol and port information for connecting to the Session Recording server. If you have not installed Session Recording yet, you can change such information later in **Session Recording Agent Properties**.
- If you are installing the Session Recording agent on an Azure AD joined machine, select **Enable Azure AD support**. To fully enable Azure AD identity support for configuring [playback permissions](#) and various Session Recording [policies](#) from the cloud, complete the following steps and then restart the VDA:

Note:

Azure AD support is a preview feature. It is available with Session Recording version 2402 and later.

Preview features might not be fully localized and are recommended for use in non-production environments. Citrix Technical Support doesn't support issues found with preview features.

- Use the MSI package to install the Session Recording server on an Azure AD joined machine

as well. Select **Enable Azure AD support** during the MSI installation.

- [Connect Citrix Cloud to Azure AD](#).
- Go to the home page for the Full Configuration interface and enable the **SessionRecordingSupportAAD** and **Send User Identity Info In Prepare Session** toggles under the **Preview features** section. To access the home page for the Full Configuration interface, complete the following steps:
 1. Sign in to [Citrix Cloud](#).
 2. In the upper left menu, select **My Services > DaaS**. By default, the home page for the Full Configuration interface appears.

Note:

There is a limitation with the test connection function of the installer. It does not support the “HTTPS requires TLS 1.2” scenario. If you use the installer in this scenario, the test connection fails but you can ignore the failure and click **Next** to continue the installation. It does not affect normal functioning.

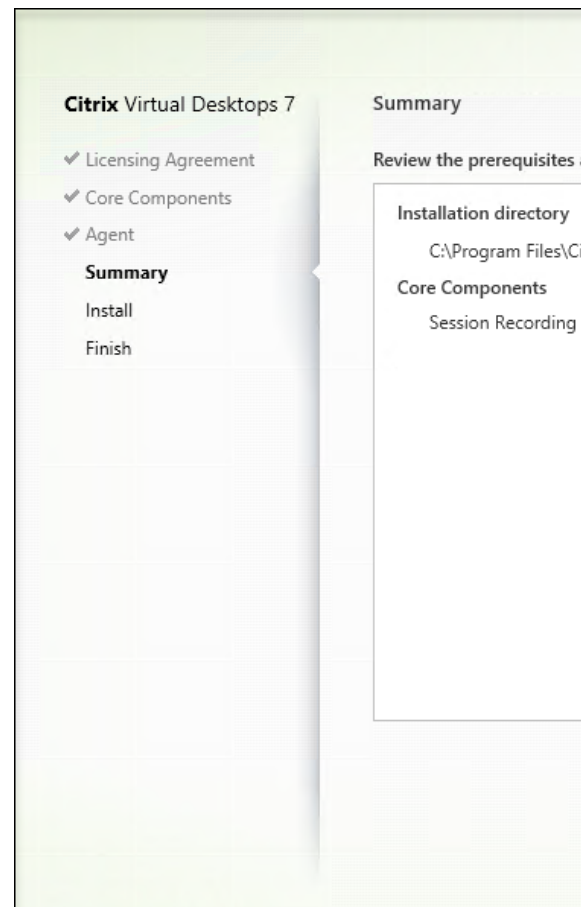

Step 7: Review the prerequisites and confirm the installation

The **Summary** page shows your installation choices. You can click **Back** to return to the earlier wizard pages and make changes, or click **Install** to start the installation.

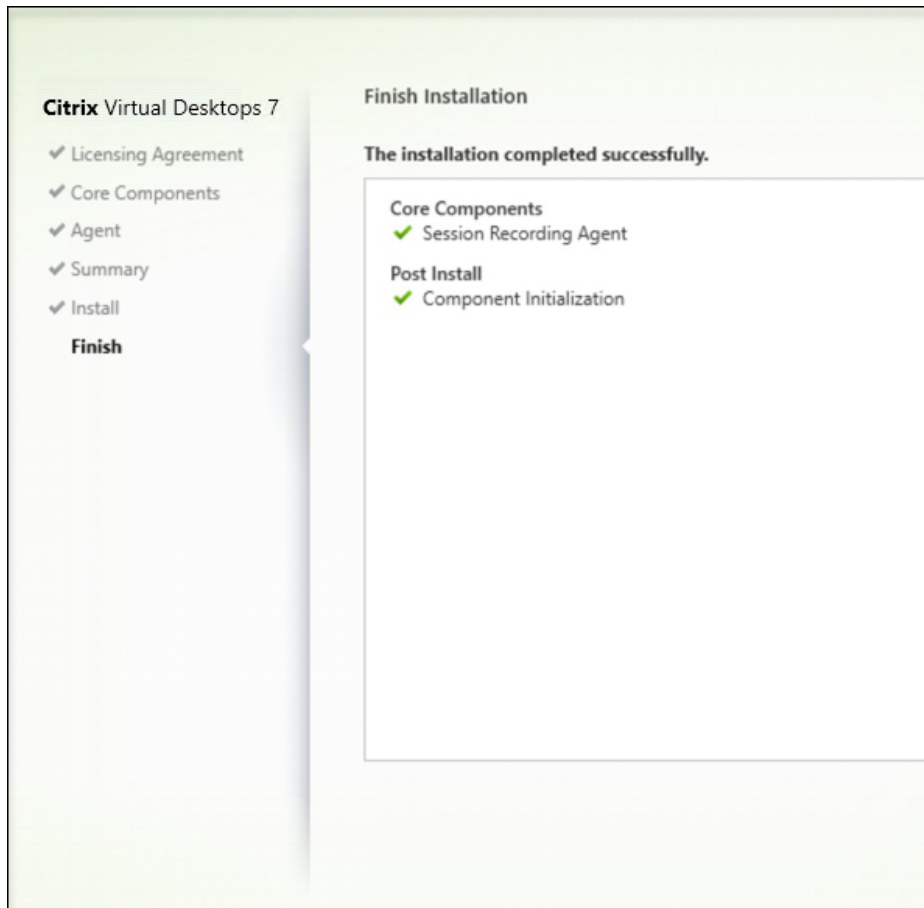

Step 8: Complete the installation

The **Finish Installation** page shows green check marks for all the prerequisites and components that have been installed and initialized successfully.

Click **Finish** to complete the installation of the Session Recording Agent.

Note:

When Machine Creation Services (MCS) or Citrix Provisioning creates multiple VDAs with a master image and Microsoft Message Queuing (MSMQ) installed, the VDAs might have the same **QMId**. The same **QMId** might cause various issues, for example:

- Sessions might not be recorded even if the recording agreement is accepted.
- The Session Recording Server might not be able to receive session logoff signals and therefore, sessions might always be in Live status.

As a workaround, create a unique **QMId** for each VDA and it differs depending on the deployment methods.

No extra actions are required if single-session OS VDAs with the Session Recording agent installed are created with PVS 7.7 or later and MCS 7.9 or later in the static desktop mode that is, for example, configured to make all changes persistent with a separate Personal vDisk or the local disk of your VDA.

For multi-session OS VDAs created with MCS or PVS and single-session OS VDAs that are configured to discard all changes when a user logs off, use the **GenRandomQMID.ps1** script to change the **QMID** on system startup. Change the power management strategy to ensure that enough VDAs are running before user logon attempts.

To use the **GenRandomQMID.ps1** script, do the following:

1. Ensure that the execution policy is set to **RemoteSigned** or **Unrestricted** in PowerShell.
Set-ExecutionPolicy RemoteSigned
2. Create a scheduled task, set the trigger as on system startup, and run with the SYSTEM account on the PVS or MCS master image machine.
3. Add the command as a startup task.

```
powershell .exe -file C:\\GenRandomQMID.ps1
```

Summary of the GenRandomQMID.ps1 script:

1. Remove the current **QMID** from the registry.
2. Add `SysPrep = 1` to `HKEY_LOCAL_MACHINE\SOFTWARE\Microsoft\MSMQ\Parameters`.
3. Stop related services, including CitrixSmAudAgent and MSMQ.
4. To generate a random **QMID**, start the services that stopped previously.

Example GENRANDOMQMID.PS1:

```
1 # Remove old QMID from registry and set SysPrep flag for MSMQ
2
3 Remove-ItemProperty -Path HKLM:Software\Microsoft\MSMQ\Parameters\
  MachineCache -Name QMID -Force
4
5 Set-ItemProperty -Path HKLM:Software\Microsoft\MSMQ\Parameters -
  Name "SysPrep" -Type DWord -Value 1
6
7 # Get dependent services
8
9 $depServices = Get-Service -name MSMQ -dependentservices | Select -
  Property Name
10
11 # Restart MSMQ to get a new QMID
12
13 Restart-Service -force MSMQ
```

```
14
15 # Start dependent services
16
17 if ($depServices -ne $null) {
18
19     foreach ($depService in $depServices) {
20
21         $startMode = Get-WmiObject win32_service -filter "NAME = '$
22 ($depService.Name)'" | Select -Property StartMode
23
24         if ($startMode.StartMode -eq "Auto") {
25
26             Start-Service $depService.Name
27         }
28     }
29 }
30
31 }
32
33
34 }
```

Install the Session Recording player

The Session Recording player is a user interface that you access from a workstation to play recorded session files. Install the Session Recording player on the Session Recording server or on workstations in the domain.

Tip:

- Installing the Session Recording server lets you install the Session Recording web player automatically.
- Before or after you install the Session Recording player, install the Microsoft Visual C++ Redistributable package called **VC_redist.x86.exe**. You can find the package on the Citrix Virtual Apps and Desktops ISO under **\Support\VcRedist**.

Step 1: Download the product software and launch the wizard Use a local administrator account to log on to the machine where you are installing the Session Recording player component. Insert the DVD in the drive or mount the ISO file. If the installer does not launch automatically, double-click the **AutoSelect** application or the mounted drive.

The installation wizard launches.

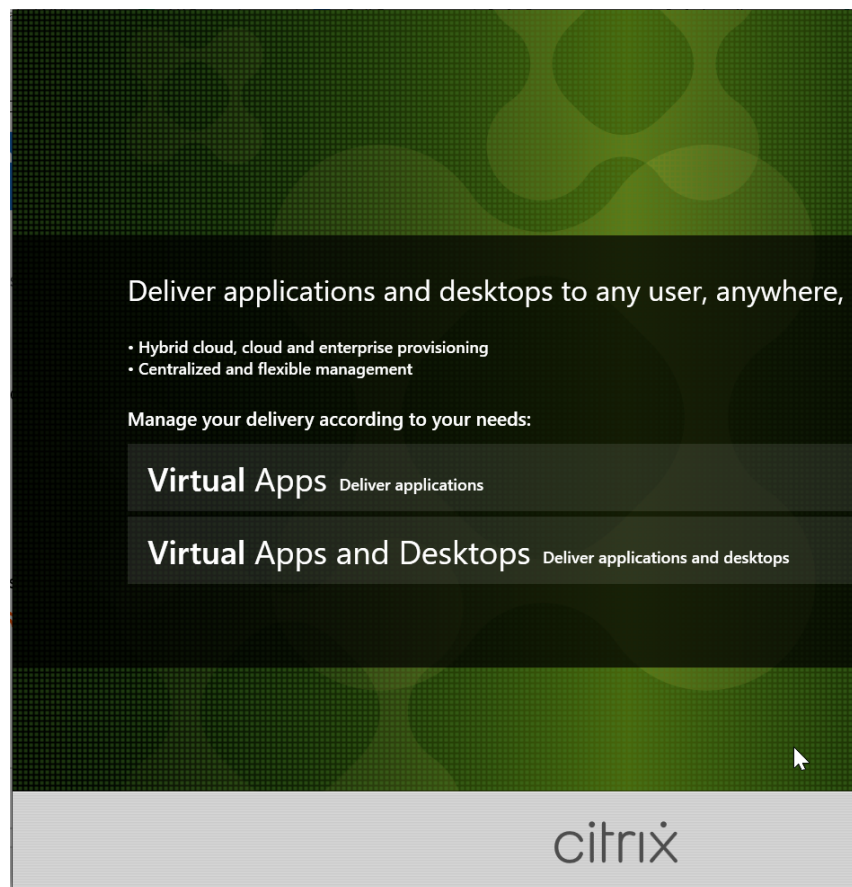

Step 2: Choose which product to install

Click **Start** next to the product to install **Citrix Virtual Apps** or **Citrix Virtual Desktops**.

The screenshot shows the navigation menu for Citrix Virtual Apps and Desktops 7. It is divided into three main sections: 'Get Started', 'Prepare Machines and Images', and 'Extend Deployment'. The 'Get Started' section includes 'Delivery Controller' with a brief description. The 'Prepare Machines and Images' section includes 'Virtual Delivery Agent for Windows' with a brief description. The 'Extend Deployment' section is a grid of links for various components, each with an information icon. At the bottom, there is a 'Services and Support' section with links to 'Product documentation' and 'Knowledge Center'.

Get Started			Prepare Machines and Images		
Delivery Controller Start here. Select and install the Delivery Controller and other essential services like License Server and StoreFront.			Virtual Delivery Agent for Windows Install this agent to deliver applications based VMs or physical machines.		
Extend Deployment					
Citrix Director		Citrix Studio		Self-Service P	
Citrix License Server		Universal Print Server		Session Recor	
Citrix StoreFront		Federated Authentication Service			

Services and Support
[Product documentation](#) Access supporting content online.
[Knowledge Center](#) Access knowledge base articles, security bulletins, and troubleshooting guides.

Step 3: Select Session Recording

Select the **Session Recording** entry.

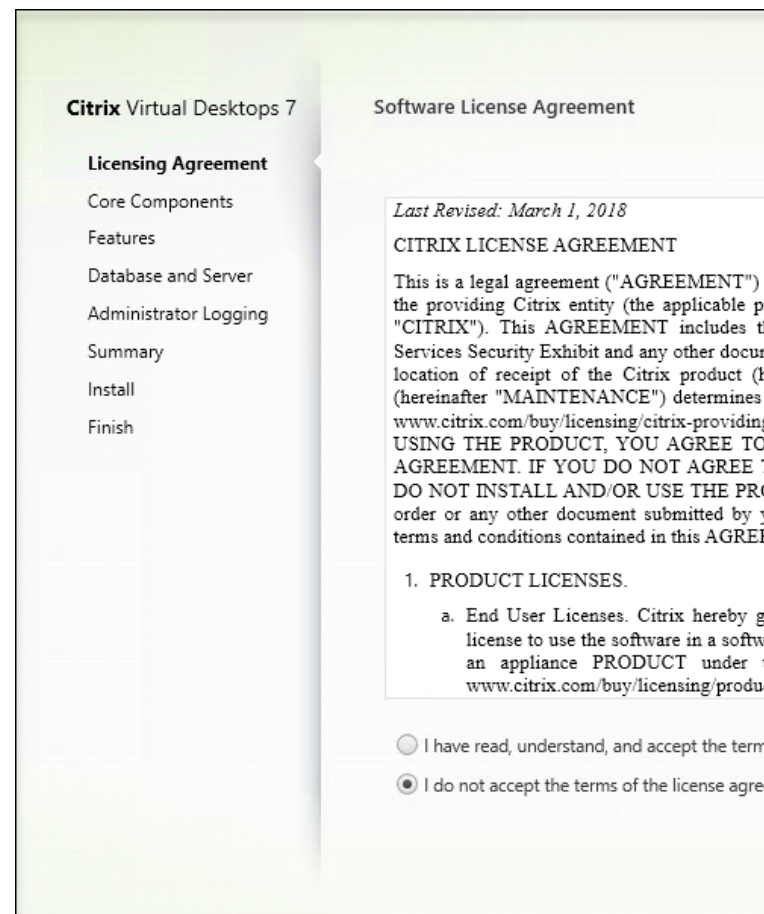

Step 4: Read and accept the license agreement

On the **Software License Agreement** page, read the license agreement, accept it, and then click **Next**.

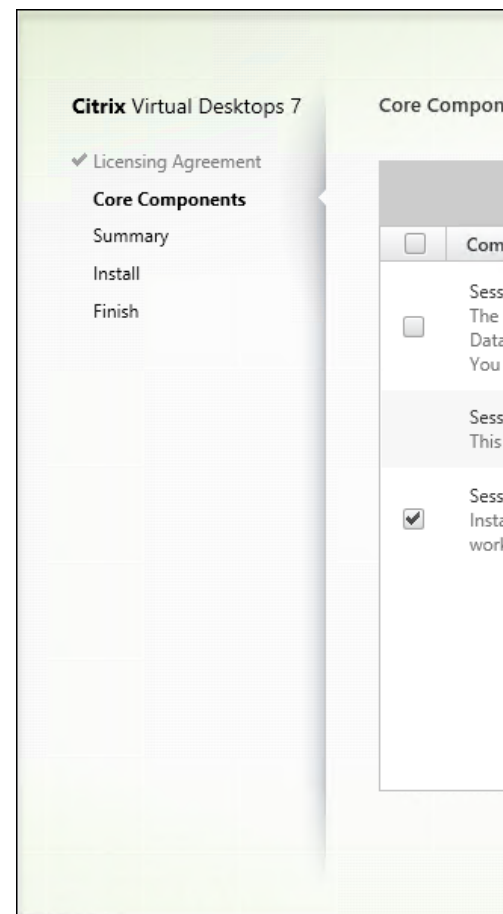

Step 5: Select the component to install and the installation location

Select **Session Recording Player** and click **Next**.

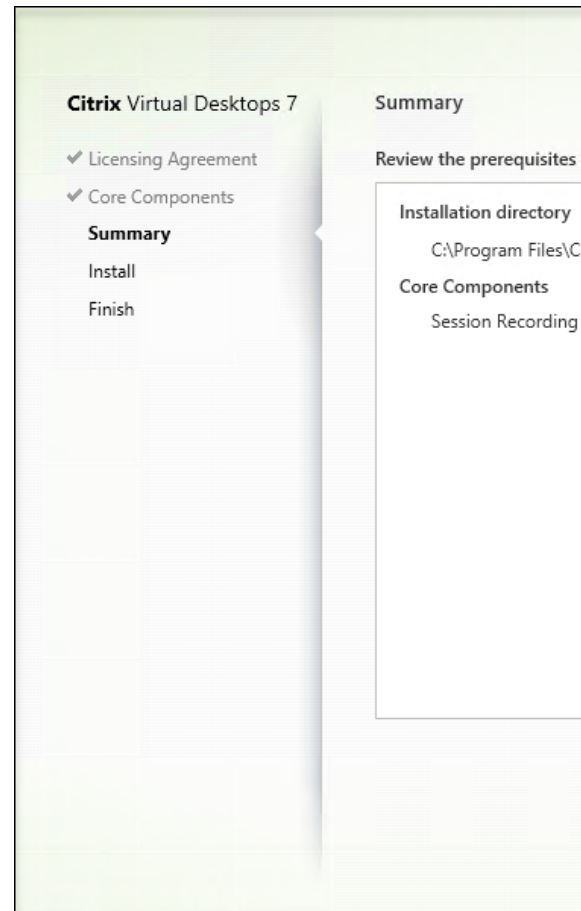

Step 6: Review the prerequisites and confirm the installation

The **Summary** page shows your installation choices. You can click **Back** to return to the earlier wizard pages and make changes, or click **Install** to start the installation.

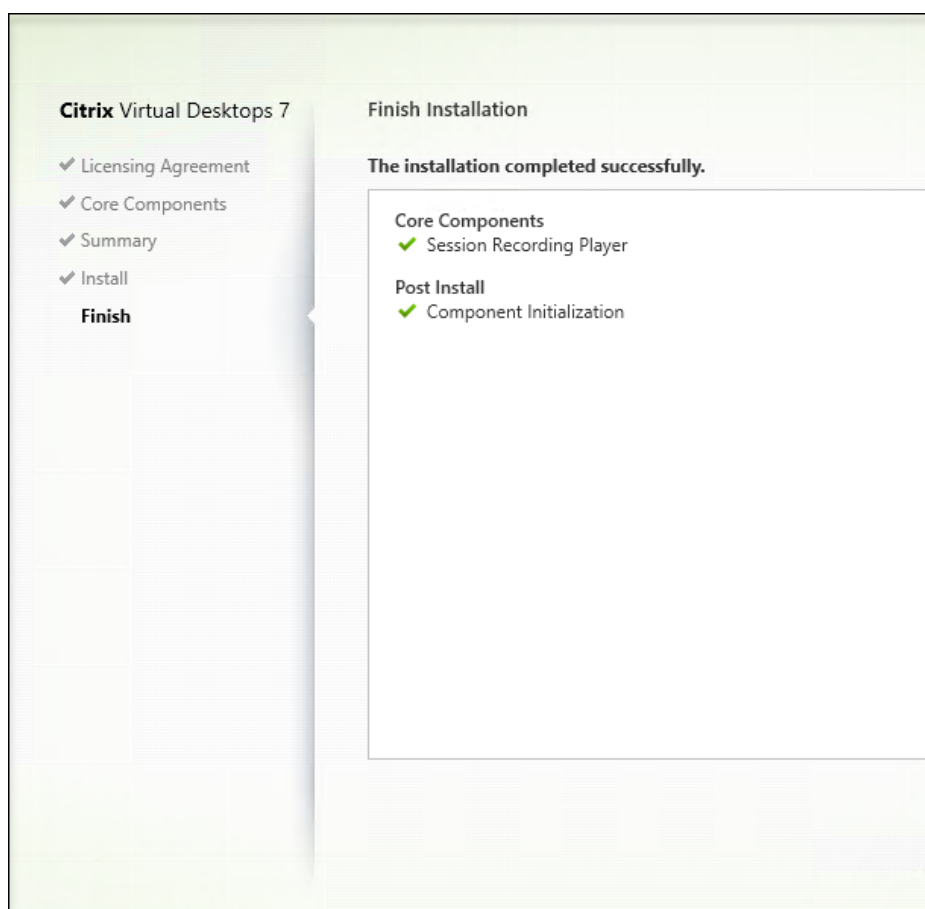

Step 7: Complete the installation

The **Finish Installation** page shows green check marks for all the prerequisites and components that have been installed and initialized successfully.

Click **Finish** to complete the installation of the Session Recording player.

Automate installation

Session Recording supports silent installation with options.

Automate installation of the Session Recording Administration components

Install the complete set of the Session Recording Administration components by using a single command For example, either of the following commands installs the complete set of the Session Recording Administration components and creates a log file to capture the installation information.

```
1 msixexec /i "c:\SessionRecordingAdministrationx64.msi" ADDLOCAL="
  SsRecServer,PolicyConsole,SsRecLogging,StorageDatabase"
  DATABASEINSTANCE="WNBIO-SRD-1" DATABASENAME="CitrixSessionRecording"
  LOGGINGDATABASENAME="CitrixSessionRecordingLogging" DATABASEUSER="
  localhost" /q /l*v "yourinstallationlog"
```

```
1 msixexec /i "SessionRecordingAdministrationx64.msi" ADDLOCAL="
  SsRecServer,PolicyConsole,SsRecLogging,StorageDatabase"
  DATABASEINSTANCE="CloudSQL" DATABASENAME="CitrixSessionRecording"
  LOGGINGDATABASENAME="CitrixSessionRecordingLogging"
  AZURESQLSERVICESUPPORT="1" AZUREUSERNAME="CloudSQLAdminName"
  AZUREPASSWORD="CloudSQLAdminPassword" SERVICEKEYAUTHENABLE="1" /q /l
  *vx "c:\WithLogging.log"
```

Note:

You can find the `SessionRecordingAdministrationx64.msi` file on the Citrix Virtual Apps and Desktops ISO under `\x64\Session Recording`.

Where:

- **ADDLOCAL** provides the features for you to select. You can select more than one option. SsRecServer is the Session Recording server. PolicyConsole is the Session Recording policy console. SsRecLogging is the Administrator Logging feature. StorageDatabase is the Session Recording database. Session Recording Administrator Logging is an optional subfeature of the Session Recording server. Select the Session Recording server before you can select Session Recording administrator logging.
- **DATABASEINSTANCE** is the instance name of the Session Recording database. For example, `.\SQLEXPRESS,computer-name\SQLEXPRESS,computer-name` or `tcp:srt-sql-support.public.ca7b16b60789.database.windows.net,3342` if you are using Azure SQL Managed Instance.
- **DATABASENAME** is the database name of the Session Recording database.
- **LOGGINGDATABASENAME** is the name of the administrator logging database.
- **AZURESQLSERVICESUPPORT** determines whether SQL Server authentication is supported. To use SQL Server authentication, set it to 1.
- **DATABASEUSER** is the computer account of the Session Recording server.
- **AZUREUSERNAME** is the SQL Server administrator name.
- **AZUREPASSWORD** is the SQL Server administrator password.
- **SERVICEKEYAUTHENABLE** enables the service key authentication between the Session Recording agent and the Session Recording server. This parameter is required only when you want to enable Azure AD support and you must set it to **1**. Otherwise, do not add this parameter.
- **/q** specifies quiet mode.
- **/l*v** specifies verbose logging.
- **yourinstallationlog** is the location of your installation log file.

Create a master image for deploying the Session Recording server You might already have the Session Recording database and the administration logging database in place from an existing deployment. For such scenarios, you can now forego database checks when you are installing the Session

Recording Administration components using `SessionRecordingAdministrationx64.msi`. You can create a master image for deploying the Session Recording server easily on many other machines. After deploying the Session Recording server on target machines using the master image, run a command on each machine to connect to the existing Session Recording database and administration logging database. This master image support facilitates deployment and minimizes the potential impact of human error. It applies only to fresh installations and consists of the following steps:

1. Start a command prompt and run a command similar to the following:

```
1 msixexec /i "SessionRecordingAdministrationx64.msi" ADDLOCAL="
  SsRecServer,PolicyConsole,SsRecLogging,StorageDatabase"
  DATABASEINSTANCE="sqlnotexists" DATABASENAME="
  CitrixSessionRecording2" LOGGINGDATABASENAME="
  CitrixSessionRecordingLogging2" DATABASEUSER="localhost" /q /l*
  vx "c:\WithLogging.log" IGNOREDBCHECK="True"
```

This command installs the Session Recording Administration components without configuring and testing connectivity to the Session Recording database and the administration logging database.

Set the **IGNOREDBCHECK** parameter to **True** and use random values for **DATABASEINSTANCE**, **DATABASENAME**, and **LOGGINGDATABASENAME**.

2. Create a master image on the machine that you are operating.
3. Deploy the master image to other machines for deploying the Session Recording server.
4. On each of the machines, run commands similar to the following:

```
1 .\SsRecUtils.exe -modifydbconnectionpara DATABASEINSTANCE
  DATABASENAME LOGGINGDATABASENAME
2
3 iisreset /noforce
```

The commands connect the Session Recording server installed earlier to an existing Session Recording database and administration logging database.

You can find the `SsRecUtils.exe` file at `\Citrix\SessionRecording\Server\bin\.` Set the **DATABASEINSTANCE**, **DATABASENAME**, and **LOGGINGDATABASENAME** parameters as needed.

Retain databases when uninstalling the Session Recording Administration components With **KEEPDB** set to **True**, the following command retains the Session Recording database and the administration logging database when uninstalling the Session Recording Administration components:

```
1 msixexec /x "SessionRecordingAdministrationx64.msi" KEEPDB="True"
```

Automate installation of the Session Recording player and web player

For example, the following commands install the Session Recording player and web player, respectively.

```
1 msiexec /i "c:\SessionRecordingPlayer.msi" /q /l*\vx "
  yourinstallationlog"
```

```
1 msiexec /i "c:\SessionRecordingWebPlayer.msi" /q /l*vx "
  yourinstallationlog"
```

Note:

You can find `SessionRecordingPlayer.msi` on the Citrix Virtual Apps and Desktops ISO under `\x86\Session Recording`.

You can find `SessionRecordingWebPlayer.msi` on the Citrix Virtual Apps and Desktops ISO under `\x64\Session Recording`.

Where:

- **/q** specifies quiet mode.
- **/l*v** specifies verbose logging.
- **yourinstallationlog** is the location of your installation log file.

Automate installation of the Session Recording agent For example, the following command installs the Session Recording agent and creates a log file to capture the installation information.

```
1 msiexec /i SessionRecordingAgentx64.msi /q /l*vx yourinstallationlog
  SESSIONRECORDINGSERVERNAME=yourservername
2 SESSIONRECORDINGBROKERPROTOCOL=yourbrokerprotocol
  SESSIONRECORDINGBROKERPORT=yourbrokerport
  SESSIONRECORDINGAUTHENTICATION="Citrix Cloud" SESSIONRECORDINGRPC="
  Websocket" SESSIONRECORDINGIDP="IDP"
```

Note:

You can find `SessionRecordingAgentx64.msi` on the Citrix Virtual Apps and Desktops ISO under `\x64\Session Recording`.

Where:

- **yourservername** is the NetBIOS name or FQDN of the machine hosting the Session Recording server. If not specified, this value defaults to **localhost**.
- **yourbrokerprotocol** is the HTTP or HTTPS that the Session Recording agent uses to communicate with the Session Recording Broker. If not specified, this value defaults to HTTPS.

- **yourbrokerport** is the port number that the Session Recording agent uses to communicate with the Session Recording Broker. If not specified, this value defaults to zero, which directs the Session Recording Agent to use the default port number for your selected protocol: 80 for HTTP or 443 for HTTPS.
- **SESSIONRECORDINGAUTHENTICATION** is the authentication type between the Session Recording agent and the Session Recording server. This parameter is required only when you want to enable Azure AD support. To enable Azure AD support, add this parameter and set it to **Citrix Cloud**.
- **SESSIONRECORDINGRPC** is the communication method between the Session Recording agent and the Session Recording server. This parameter is required only when you want to enable Azure AD support. To enable Azure AD support, add this parameter and set it to **Websocket**.
- **SESSIONRECORDINGIDP** specifies the identity type. This parameter is required only when you want to enable Azure AD support. To enable Azure AD support, add this parameter and set it to **IDP**.
- **/q** specifies quiet mode.
- **/l*v** specifies verbose logging.
- **yourinstallationlog** is the location of your installation log file.

Upgrade Session Recording

You can upgrade certain deployments to later versions without having to first set up new machines or sites. You can upgrade from the version of Session Recording included in the latest CU of XenApp and XenDesktop 7.6 LTSR, and from any later version, to the latest release of Session Recording.

Note:

When you upgrade Session Recording Administration from 7.6 to 7.13 or later and choose **Modify** in Session Recording Administration to add the administrator logging service, the SQL Server instance name does not appear on the **Administrator Logging Configuration** page. The following error message appears when you click **Next: Database connection test failed. Please enter correct Database instance name**. As a workaround, add the **read** permission for localhost users to the following SmartAuditor Server registry folder: `HKEY_LOCAL_MACHINE\SOFTWARE\Citrix\SmartAuditor\Server`.

You cannot upgrade from a Technical Preview version.

Requirements, preparation, and limitations

- Use the Session Recording installer's graphical or command-line interface to upgrade the Session Recording components on the machine where you installed the components.

- Before any upgrade activity, back up the database named CitrixSessionRecording in the SQL Server instance. In this way, you can restore it if any issues are discovered after the database upgrade.
- In addition to being a domain user, you must be a local administrator on the machines where you are upgrading the Session Recording components.
- If the Session Recording server and Session Recording database aren't installed on the same server, you must have the database role permission to upgrade the Session Recording database. Otherwise, you can:
 - Ask the database administrator to assign the **securityadmin** and **dbcreator** server role permissions for the upgrade. After the upgrade completes, the **securityadmin** and **dbcreator** server role permissions are no longer necessary and can be safely removed.
 - Or, use the SessionRecordingAdministrationx64.msi package to upgrade. During the msi upgrade, a dialog box prompts for the credentials of a database administrator who has the **securityadmin** and **dbcreator** server role permissions. Type the correct credentials and then click **OK** to continue the upgrade.
- You can choose not to upgrade all Session Recording agents at the same time. Session Recording agent 7.6.0 (and later) is compatible with the latest (current) release of the Session Recording server. However, some new features and bug fixes might not take effect.
- Any sessions started during the upgrade of the Session Recording server are not recorded.
- The **Graphics Adjustment** option in Session Recording agent Properties is enabled by default after a fresh installation or upgrade to keep compatible with the Desktop Composition Redirection mode. You can disable this option manually after a fresh installation or upgrade.
- The administrator logging feature is not installed after you upgrade Session Recording from a previous release where the feature is unavailable. To add the feature, modify the installation after the upgrade.
- If there are live recording sessions when the upgrade process starts, there is little chance that the recording can be complete.
- Review the following upgrade sequence, so that you can plan and mitigate potential outages.

Upgrade sequence

To upgrade an existing installation, go to each machine where a Session Recording component is installed and then run the Citrix Virtual Apps and Desktops ISO.

Tip:

Go to the [Citrix Virtual Apps and Desktops download page](#) to download the appropriate version of Citrix Virtual Apps and Desktops.

Upgrading an existing installation generally follows the following sequence:

1. Upgrade the Session Recording server component.

If there is more than one Session Recording server, first upgrade the one where the Session Recording database component is installed. After that, upgrade the rest Session Recording servers.

To do so, complete the following steps:

- a) Stop the Session Recording Storage Manager service manually on the Session Recording server.
 - b) Through the Internet Information Services (IIS) Manager, ensure that the Session Recording Broker is running.
 - c) Run the Citrix Virtual Apps and Desktops ISO and select the Session Recording entry to upgrade.
2. The Session Recording service is back online automatically when the upgrade of the Session Recording server is completed.
 3. Upgrade the Session Recording agent (on the master image).
 4. Upgrade the Session Recording policy console with or after the Session Recording server.
 5. Upgrade the Session Recording player.

Install the Session Recording database on cloud SQL database services

This section describes how to install the Session Recording database on the following cloud SQL database services:

- Azure SQL Database
- Azure SQL Managed Instance
- SQL Server on Azure VMs
- AWS RDS
- Google Cloud SQL Server

Install the Session Recording database on Azure SQL Database

1. Create an Azure SQL Database.
 - a) Sign in to the Azure portal using your Azure account.
 - b) From the portal menu, select **Create a resource**.
 - c) In the portal search box, enter **SQL database**.
 - d) From the list of search results, select **SQL databases**.

- e) Click **Create** to create an Azure SQL Database.
- f) In the **Create SQL Database** section, provide the following information:
 - **Subscription:** Select the Azure subscription that you want.
 - **Resource Group:** Select **Create new** or choose an existing resource group.
 - **Database Name:** A unique name is required.
 - **Server:** Select Create new, and fill out the **New Server** form with the following values:
 - **Server name:** Enter a unique name. Server names must be globally unique for all servers in Azure.
 - **Location:** Select a location from the drop-down list.
 - **Authentication method:** Select Use SQL authentication.
 - **Server admin login:** Enter a SQL Server administrator name.
 - **Password:** Enter a SQL Server administrator password that meets requirements and enter it again in the **Confirm password** field.
 - Select **OK**.

After providing the preceding information, click **Review + Create**. Click the **Create** button to complete the Azure SQL Database.

2. Repeat Step 1 to create a different Azure SQL Database on the same **Server**.
3. Get the server connection string for the created Azure SQL Databases.
 - a) In the Azure portal, search for and click either of the Azure SQL Databases that you have created.
 - b) Click **Connection strings** from the left navigation.
 - c) Keep a record of the **Server** string that is to be used as the instance name of the Session Recording database and the Session Recording logging database later.
4. Run a command similar to the following to install the Session Recording database on the Azure SQL Database that you have created earlier.

Note:

On Azure SQL Database, installation of the Session Recording database can be done **only by** running a command similar to the following:

```
msiexec /i "SessionRecordingAdministrationx64.msi"ADDLOCAL="SsRecServer,PolicyConsole,SsRecLogging,StorageDatabase"DATABASEINSTANCE="DatabaseConnectionString"DATABASENAME="CitrixSessionRecording"LOGGINGDATABASENAME="CitrixSessionRecordingLogging"AZURESQLSERVICESUPPORT="1"CLOUDDSUPPORT="1"AZUREUSERNAME="CloudSQLAdminName"AZUREPASSWORD="CloudSQLAdminPassword"/q /l*vx "c:\WithLogging.log"
```

Where:

- **ADDLOCAL** provides the features for you to select. You can select more than one option. SsRecServer is the Session Recording server. PolicyConsole is the Session Recording policy console. SsRecLogging is the Administrator Logging feature. StorageDatabase is the Session Recording database. Session Recording Administrator Logging is an optional sub-feature of the Session Recording server. Select the Session Recording server before you can select Session Recording administrator logging.
- **DATABASEINSTANCE** is the instance name of the Session Recording database, which is specified by the Azure SQL Database connection string.
- **DATABASENAME** is the database name of the Session Recording database.
- **LOGGINGDATABASENAME** is the name of the administrator logging database.
- **AZURESQLSERVICESUPPORT** determines whether SQL Server authentication is supported. To use SQL Server authentication, set it to 1.
- **DATABASEUSER** is the computer account of the Session Recording server.
- **AZUREUSERNAME** is the SQL Server administrator name.
- **AZUREPASSWORD** is the SQL Server administrator password.
- **/q** specifies quiet mode.
- **/l*v** specifies verbose logging.
- **yourinstallationlog** is the location of your installation log file.

Install the Session Recording database on Azure SQL Managed Instance or on AWS RDS

Tip:

On Azure SQL Managed Instance and on AWS RDS, you can install the Session Recording database by:

- Double-clicking and running the SessionRecordingAdministrationx64.msi package.
- Running a command similar to the following:

```
1  msixec /i "SessionRecordingAdministrationx64.msi" ADDLOCAL="
    SsRecServer,PolicyConsole,SsRecLogging,StorageDatabase"
    DATABASEINSTANCE="CloudSQL" DATABASENAME="
    CitrixSessionRecording" LOGGINGDATABASENAME="
    CitrixSessionRecordingLogging" AZURESQLSERVICESUPPORT="1"
    AZUREUSERNAME="CloudSQLAdminName" AZUREPASSWORD="
    CloudSQLAdminPassword" /q /l*vx "c:\WithLogging.log"
```

1. Create an Azure SQL Managed instance or create a SQL Server instance through the Amazon RDS console.
2. (For Azure SQL only) Keep a record of the **Server** strings that appear in the properties panel. The strings are the instance name of the Session Recording database. For an example, see the following screen capture.

```
ADO.NET  JDBC  ODBC  PHP
ADO.NET (SQL authentication) - private endpoint
Server=tcp:sr-sqlinstance.3141e49e4d94.database.windows.net,1433;Persist Security Info=False;User ID={your_username};Password={your_password};MultipleActiveResultSets=False;Encrypt=True;TrustServerCertificate=False;Connection Timeout=30;
ADO.NET (SQL authentication) - public endpoint
Server=tcp:sr-sqlinstance.public.3141e49e4d94.database.windows.net,3342;Persist Security Info=False;User ID={your_username};Password={your_password};MultipleActiveResultSets=False;Encrypt=True;TrustServerCertificate=False;Connection Timeout=30;
```

- 3. (For AWS RDS only) Keep a record of the **Endpoint** and **Port** information. We use it as the instance name of your database, in the format of **<Endpoint, Port>**.

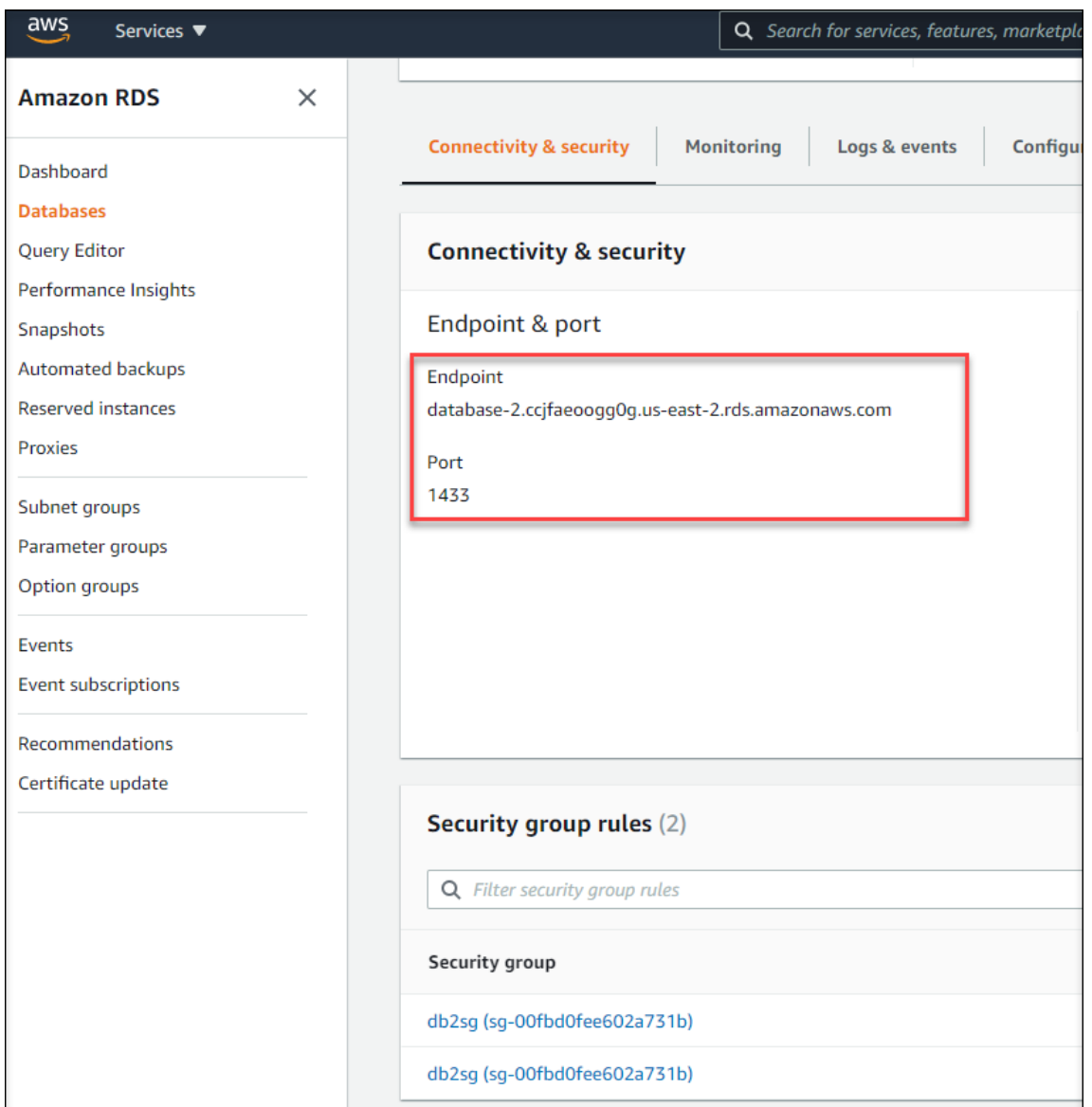

- 4. Run SessionRecordingAdministrationx64.msi to install the Session Recording database.

Select the **Enable SQL Server authentication** check box and fill in the SQL Server administrator name and password. Make other required configurations.

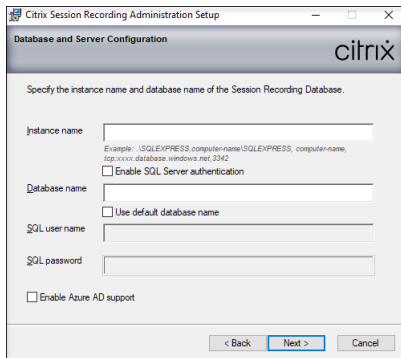

The screenshot shows a Windows dialog box titled "Citrix Session Recording Administration Setup" with a sub-tab "Database and Server Configuration". The Citrix logo is in the top right. The main text says "Specify the instance name and database name of the Session Recording Database." There are four input fields: "Instance name" (with a small example text below it: ".\SQLEXPRESS, computer-name\SQLEXPRESS, computer-name, top=cn=cn=database.windows.net,3142"), "Database name" (with a checkbox "Enable SQL Server authentication" and "Use default database name" below it), "SQL user name", and "SQL password". At the bottom left is a checkbox "Enable Azure AD support". At the bottom right are three buttons: "< Back", "Next >", and "Cancel".

Note:

If you change the SQL Server administrator password, you must update the password in **Session Recording Server Properties**. When you open **Session Recording Server Properties**, an error message appears. Click **OK** to proceed, select the **Cloud DB** tab, and type the new SQL Server administrator password. Restart the Citrix Session Recording Analytics service, the Citrix Session Recording Storage Manager service, and the IIS service.

Azure AD authentication is not supported.



Migrate an on-premises database to cloud SQL Managed Instance

1. Migrate your on-premises database according to <https://docs.microsoft.com/en-us/data-migration/> or <https://docs.aws.amazon.com/prescriptive-guidance/latest/patterns/migrate-an-on-premises-microsoft-sql-server-database-to-amazon-rds-for-sql-server.html>.
2. To make Session Recording work properly after the migration, run SsRecUtils.exe on the Session Recording server.

```
C:\Program Files\Citrix\SessionRecording\Server\bin\SsRecUtils.exe -modifyazuredbconnectionpara { Database Instance } { Session
```

```
Recording Database Name } { Session Recording Logging Database  
Name } { AzureAdminName } { AzureAdminPassword } iisreset /  
noforce
```

3. On the Session Recording server, restart the Citrix Session Recording Analytics service, the Citrix Session Recording Storage Manager service, and the IIS service.

Migrate a production database from Azure SQL Managed Instance to an on-premises database

1. Migrate the database according to <https://docs.microsoft.com/en-us/data-migration/>.
2. To make Session Recording work properly after the migration, run SsRecUtils.exe on the Session Recording server.

```
C:\Program Files\Citrix\SessionRecording\Server\bin\SsRecUtils  
.exe -modifydbconnectionpara { Database Instance } { Session  
Recording Database Name } { Session Recording Logging Database  
Name } iisreset /noforce
```

3. On the Session Recording server, restart the Citrix Session Recording Analytics service, the Citrix Session Recording Storage Manager service, and the IIS service.

Install the Session Recording database on SQL Server on Azure VMs

On SQL Server on Azure VMs, you can install the Session Recording database by double-clicking and running the SessionRecordingAdministrationx64.msi package or by using the Citrix Virtual Apps and Desktops installer.

1. Check out an Azure SQL VM.
2. Configure the VM and add it to the domain where you install the Session Recording components.
3. Use the VM's FQDN as the instance name during the installation of the Session Recording database.

Note: If you are using SessionRecordingAdministrationx64.msi for the installation, clear the **Enable SQL Server authentication** check box.

4. Follow the installation user interface to complete installing the Session Recording database.

Install the Session Recording database on Google Cloud SQL Server

Tip:

On Google Cloud SQL Server, installation of the Session Recording database can be done by running a command similar to the following or by double-clicking and running the Session-

RecordingAdministrationx64.msi package. For a description of the command parameters, see the preceding [Automate installation](#) section in this article.

```
1 msiexec /i "SessionRecordingAdministrationx64.msi" ADDLOCAL="
  SsRecServer,PolicyConsole,SsRecLogging,StorageDatabase"
  DATABASEINSTANCE="CloudSQL" DATABASENAME="CitrixSessionRecording
  " LOGGINGDATABASENAME="CitrixSessionRecordingLogging"
  AZURESQLSERVICESUPPORT="1" AZUREUSERNAME="CloudSQLAdminName"
  AZUREPASSWORD="CloudSQLAdminPassword" /q /l*vx "c:\WithLogging.
  log"
```

This section details the installation method by using SessionRecordingAdministrationx64.msi that you can find on the Citrix Virtual Apps and Desktops ISO under **\x64\Session Recording**.

1. Create a SQL Server instance in Google Cloud.

- a) Go to the Google Cloud console and open the SQL instances page.
- b) Click **CREATE INSTANCE**. For example:

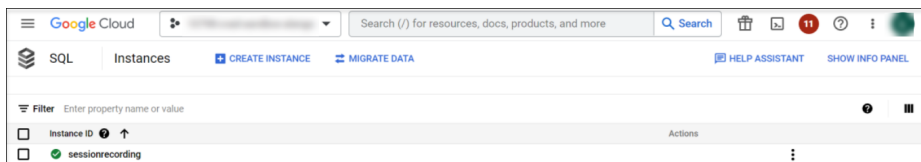

c) Choose **SQL Server** as your database engine.

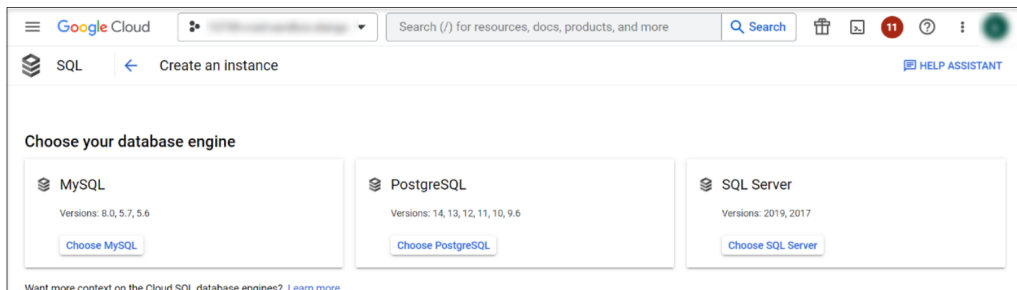

- d) Fill in the **Instance ID** field and enter a password for the user. Keep a record of the password. Select a SQL Server version for your instance. Do other configurations as needed. For example:

Instance info

Instance ID *
testinstance

Use lowercase letters, numbers, and hyphens. Start with a letter.

Password *

GENERATE

Your default service admin username is "sqlserver" [Learn more](#)

Database version *
SQL Server 2019 Standard

Choose a configuration to start with

These suggested configurations will pre-fill this form as a starting point for creating an instance. You can customize as needed later.

i You've made changes that override the selected configuration. [RESET](#)

Production
Optimized for the most critical workloads. Highly available, performant, and durable.

Development
Performant but not highly available, while reducing cost by provisioning less compute and storage.

[CONFIGURATION DETAILS](#)

Choose region and zonal availability

For better performance, keep your data close to the services that need it. Region is permanent, while zone can be changed any time.

Region
us-central1 (Iowa)

Zonal availability

Single zone
In case of outage, no failover. Not recommended for production.

Multiple zones (Highly available)
Automatic failover to another zone within your selected region. Recommended for production instances. Increases cost.

Primary zone
Any

[HIDE ZONES](#)

Summary

Region	us-central1 (Iowa)
DB Version	SQL Server 2019 Standard
vCPUs	4 vCPU
Memory	26 GB
Storage	100 GB
Network throughput (MB/s)	1,000 of 2,000
Disk throughput (MB/s)	Read: 48.0 of 240.0 Write: 48.0 of 240.0
IOPS	Read: 3,000 of 15,000 Write: 3,000 of 15,000
Connections	Public IP
Backup	Automated
Availability	Single zone
Point-in-time recovery	Disabled

- e) Assign the instance a public IP address and set an authorized network that can connect to the instance. In the **Network** field, enter the IP address of the machine where the Session Recording server is installed. For example:

Create a SQL Server instance

Customize your instance
You can also customize instance configurations later

Machine type
Machine has 4 vCPUs and 26 GB of memory.

Storage
Storage type is SSD. Storage size is 100 GB, and will automatically scale as needed. Google-managed key enabled (most common).

Connections
Choose how you want your source to connect to this instance, then define which networks are authorized to connect. You can use the Cloud SQL Proxy for extra security with either option.

Instance IP assignment
 Private IP
 Public IP

Authorized networks
You can specify CIDR ranges to allow IP addresses in those ranges to access your instance.

New network
 Name: test
 Network: [redacted]
 Example: 199.27.25.0/24
 CANCEL DONE

ADD A NETWORK

Authentication
No Active Directory domain selected

Data Protection
Automatic backups enabled. Point-in-time recovery (via transaction logs) disabled. Instance deletion protection enabled.

Summary

Region	us-central1 (Iowa)
DB Version	SQL Server 2019 Standard
vCPUs	4 vCPU
Memory	26 GB
Storage	100 GB
Network throughput (MB/s)	1,000 of 2,000
Disk throughput (MB/s)	Read: 48.0 of 240.0 Write: 48.0 of 240.0
IOPS	Read: 3,000 of 15,000 Write: 3,000 of 15,000
Connections	Public IP
Backup	Automated
Availability	Single zone
Point-in-time recovery	Disabled

f) Click **CREATE INSTANCE** and wait for a few minutes.

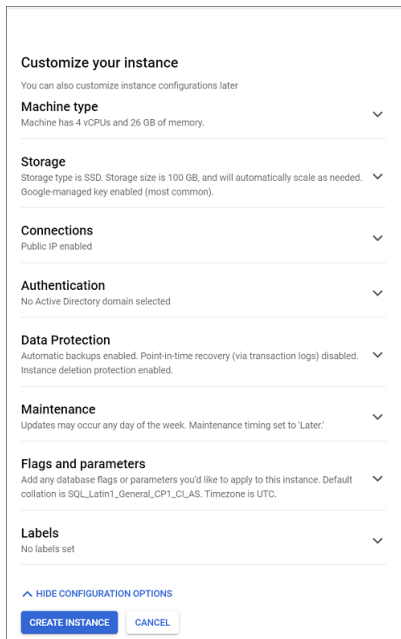

g) On the page of the newly created instance, find the public IP address and keep a record of it.

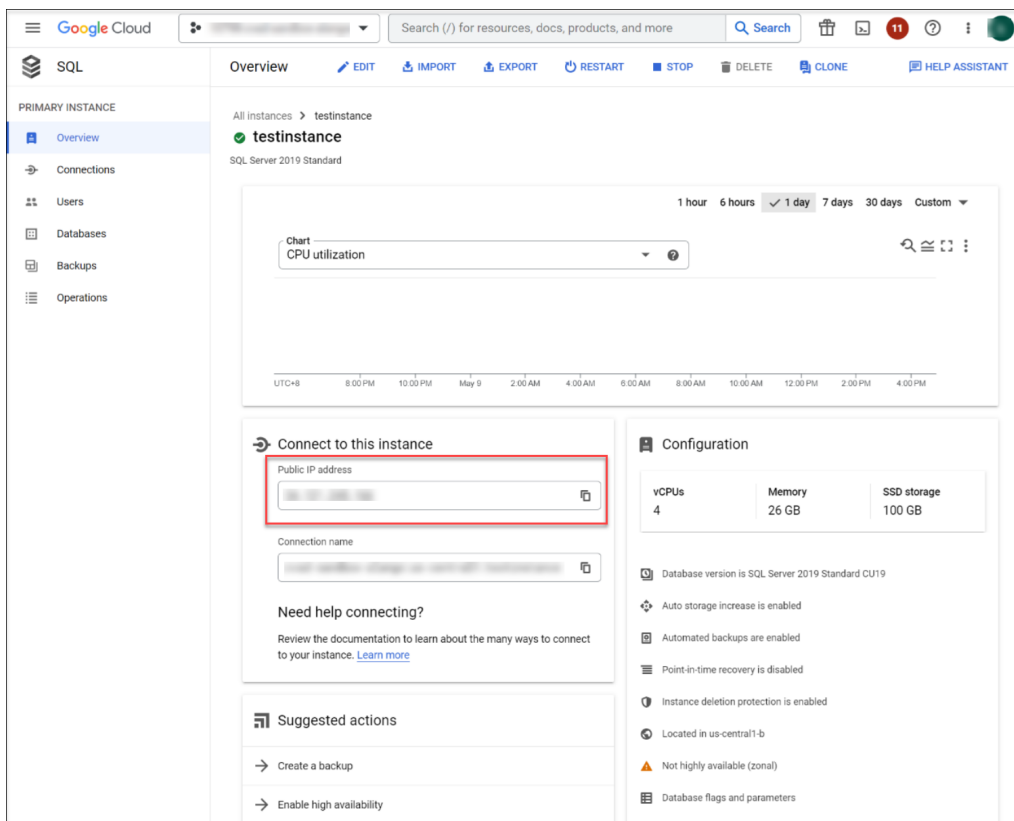

h) Run SessionRecordingAdministrationx64.msi to install the Session Recording database.

On the following page during the installation, make the following configurations:

- Select the **Enable SQL Server authentication** check box.
- In the **Instance name** field, enter the public IP address of the SQL Server instance that you created earlier.
- Fill in the SQL Server administrator name and password.

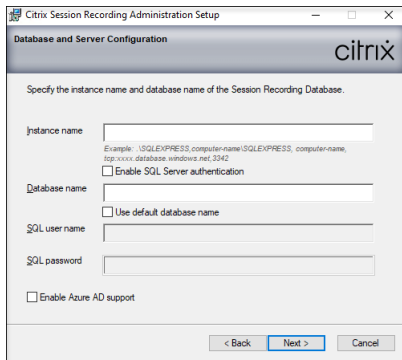

Uninstall Session Recording

To remove the Session Recording components from a server or workstation, use the uninstall or remove programs option available from the Windows Control Panel. To remove the Session Recording database, you must have the same **securityadmin** and **dbcreator** SQL Server role permissions as when you installed it.

For security reasons, the administrator logging database is not removed after the components are uninstalled.

Integrate with Citrix Analytics for Security

You can configure Session Recording servers to send user events to Citrix Analytics for Security, which processes the user events to provide actionable insights into user behaviors.

Prerequisites

Before you begin, ensure the following:

- The Session Recording server must be able to connect to the following addresses:
 - https://*.cloud.com
 - https://*.citrixdata.com
 - <https://api.analytics.cloud.com>

- The Session Recording deployment must have port 443 open for outbound internet connections. Any proxy servers on the network must allow this communication with Citrix Analytics for Security.
- If you are using Citrix Virtual Apps and Desktops 7 1912 LTSR, the supported Session Recording version is 2103 or later.

Connect your Session Recording server to Citrix Analytics for Security

1. Sign in to Citrix Cloud.
2. Find Citrix Analytics for Security and click **Manage**.
3. From the top bar, click **Settings > Data Sources**.
4. On the **Virtual Apps and Desktops- Session Recording** site card, click **Connect Session Recording server**.

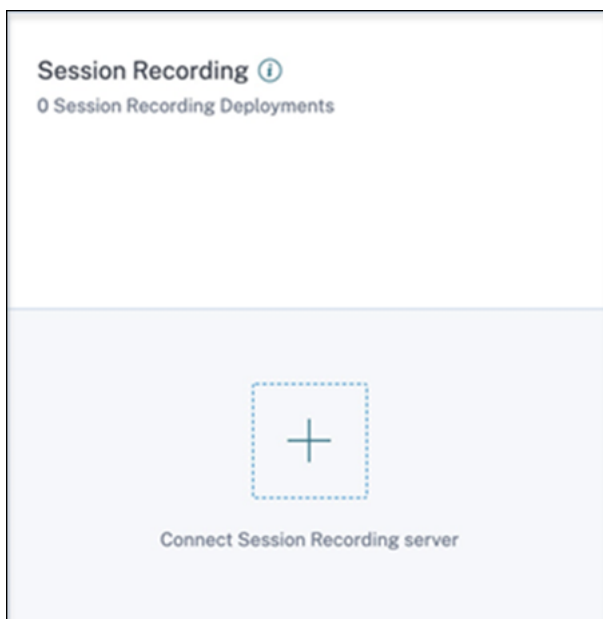

5. On the **Connect Session Recording Server** page, review the checklist, and select all the mandatory requirements. If you do not select a mandatory requirement, the **Download File** option is disabled.

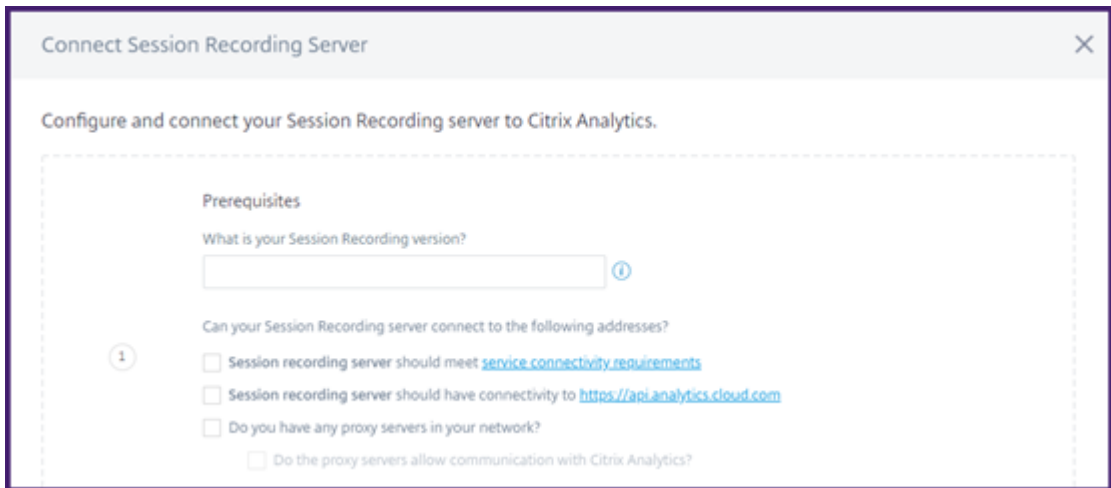

6. If you have proxy servers in your network, enter the proxy address in the *SsRecStorageManager.exe.config* file in your Session Recording server.

You can find the configuration file at <Session Recording server installation path>\bin\SsRecStorageManager.exe.config

For example: C:\Program Files\Citrix\SessionRecording\Server\Bin\SsRecStorageManager.exe.config

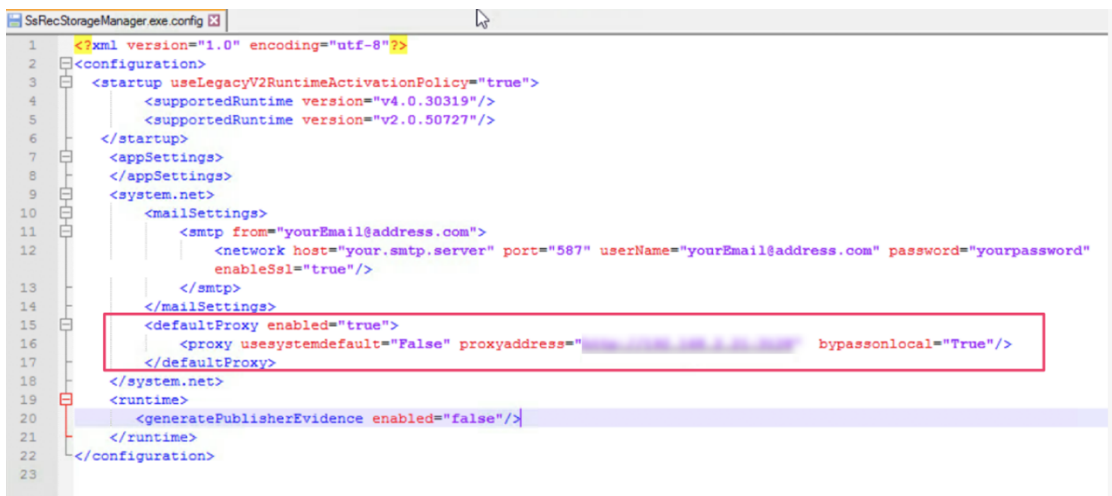

7. Click **Download File** to download the *SessionRecordingConfigurationFile.json* file.

Note:

The file contains sensitive information. Keep the file in a safe and secure location.

8. Copy the file to the Session Recording server that you want to connect to Citrix Analytics for Security.
9. If you have multiple Session Recording servers in your deployment, you must copy the file in each server that you want to connect and follow the steps to configure each server.

10. On the Session Recording server, run the following command to import the settings:

```
1 <Session Recording server installation path>\bin\SsRecUtils.exe -
  Import_SRCasConfigurations <configuration file path>
```

For example:

```
1 C:\Program Files\Citrix\SessionRecording\Server\bin\SsRecUtils.exe
  -Import_SRCasConfigurations C:\Users\administrator\Downloads\
  SessionRecordingConfigurationFile.json
```

11. Restart the following services:

- Citrix Session Recording Analytics Service
- Citrix Session Recording Storage Manager

12. After configuration is successful, go to Citrix Analytics for Security to view the connected Session Recording server. Click **Turn On Data Processing** to allow Citrix Analytics for Security to process the data.

Note:

If you are using Session Recording server version 2103 or 2104, you must first launch a Virtual Apps and Desktops session to view the connected Session Recording server on Citrix Analytics for Security. Otherwise the connected Session Recording server fails to get displayed. This requirement is not applicable for Session Recording server version 2106 and later.

View the connected deployments

The server deployments appear on the Session Recording site card only if the configuration is successful. The site card shows the number of configured servers that have established connections with Citrix Analytics for Security.

If you don't see your Session Recording servers even after the configuration was successful, refer to the troubleshooting section at [Configured Session Recording server fails to connect](#).

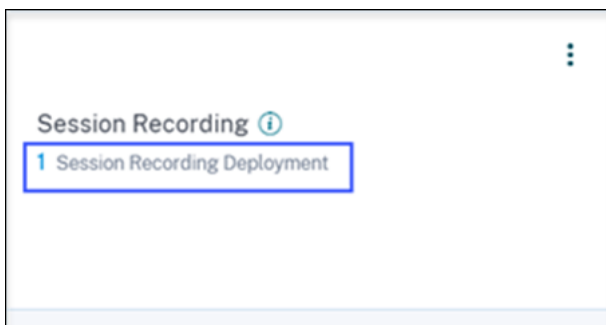

On the site card, click the number of deployments to view the connected server groups with Citrix Analytics for Security. For example, click **1 Session Recording Deployment** to view the connected server or server groups. Each Session Recording server is represented by a base URL and a ServerGroupID.

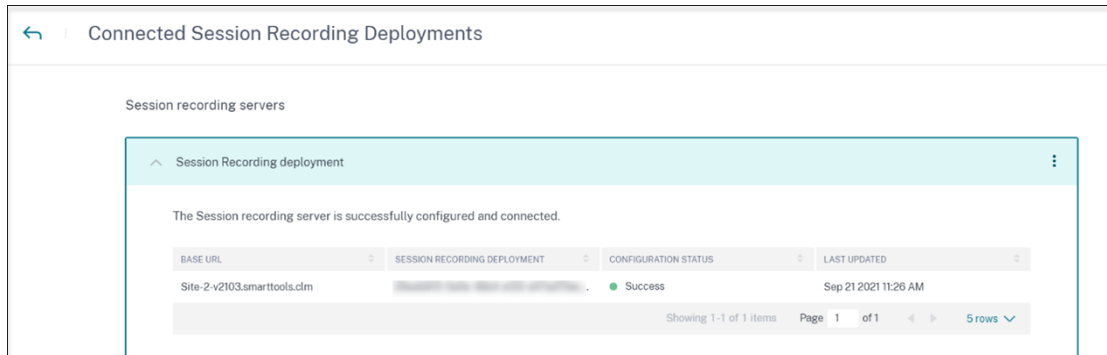

View received events

The site card displays the connected Session Recording deployments and the events received from these deployments for the last one hour, which is the default time selection. You can also select 1 week (1 W) and view the data. Click the number of received events to view the events on the self-service search page.

After you have enabled data processing, the site card might display the **No data received** status. This status appears for two reasons:

1. If you have turned on data processing for the first time, the events take some time to reach the event hub in Citrix Analytics. When Citrix Analytics receives the events, the status changes to **Data processing on**. If the status does not change after some time, refresh the Data Sources page.
2. Citrix Analytics has not received any events from the data source in the last one hour.

Add Session Recording servers

To add a Session Recording server, do one of the following:

- On the **Connected Session Recording Deployments** page, click **Connect to Session recording server**.

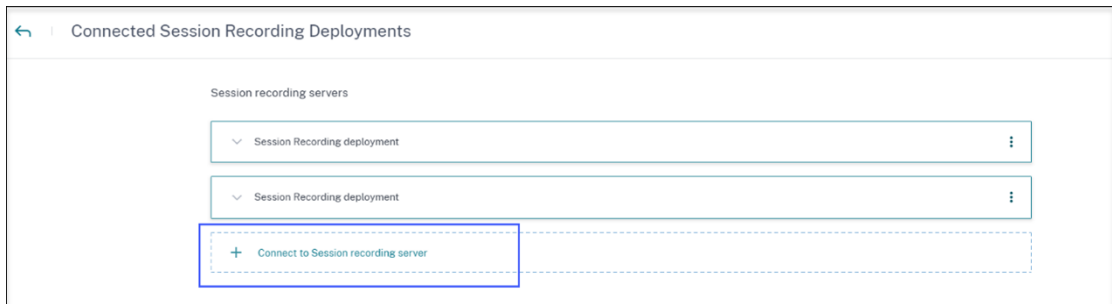

- On the **Virtual Apps and Desktops- Session Recording** site card, click the vertical ellipsis (⋮) and then select **Connect Session Recording server**.

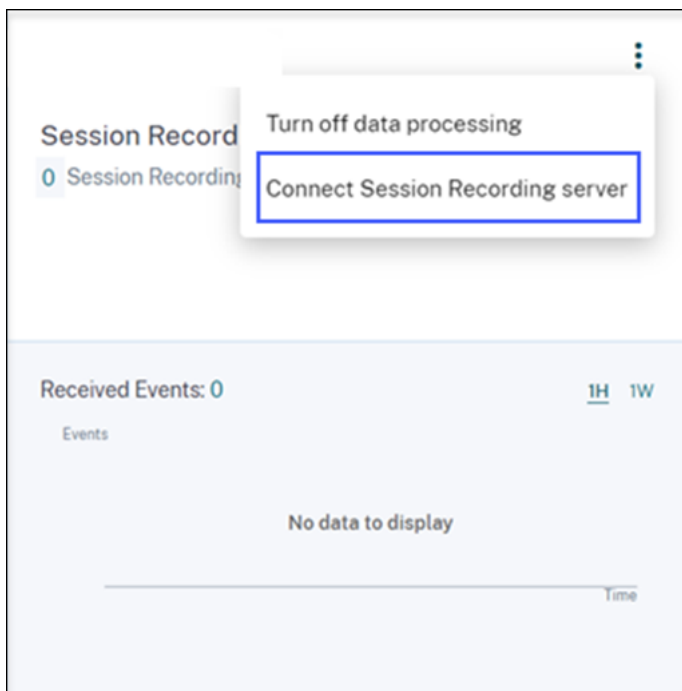

Follow the steps to download the configuration file and configure a Session Recording server.

Remove Session Recording servers

To remove a Session Recording server:

1. On Citrix Analytics for Security, go to the **Connected Session Recording Deployments** page and select the server deployment that you want to remove.
2. Click the vertical ellipses (⋮) and select **Remove Session Recording server from Analytics**.

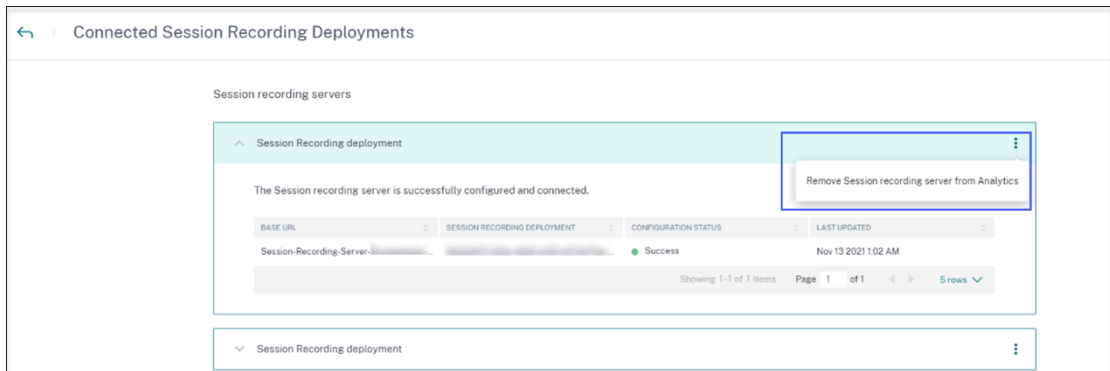

3. On the Session Recording server that you have removed from Citrix Analytics, run the following command:

```
1 <Session Recording server installation path>\bin\SsRecUtils.exe - Remove_SRCAsConfigurations
```

For example:

```
1 C:\Program Files\Citrix\SessionRecording\Server\bin\SsRecUtils.exe -Remove_SRCAsConfigurations
```

Turn on or off data processing on the data source

You can stop the data processing at any time for a particular data source- Director and Workspace app. On the data source site card, click the vertical ellipsis (⋮) and then select **Turn off data processing**. Citrix Analytics stops processing data for that data source. You can also stop the data processing from the Virtual Apps and Desktops site card. This option applies to both data sources- Director and Workspace app.

To enable data processing again, click **Turn On Data Processing**.

Configured Session Recording server fails to connect

Your Session Recording server fails to connect to Citrix Analytics after configuration. Therefore, you don't see the configured server on the **Session Recording** site card.

To troubleshoot this issue, do the following:

1. On your configured Session Recording server, run the following PowerShell command to check the Client Machine Identification (CMID):

```
1 Get-WmiObject -class SoftwareLicensingService | select Clientmachineid
```

2. If CMID is empty, add the following registry files in the specified paths:

Registry name	Registry path	Key type	Value
AuditorUniqueID	Computer\ HKEY_LOCAL_MACHINE\ \SOFTWARE\ Citrix\ SmartAuditor\ Server\ Computer\ HKEY_LOCAL_MACHINE	String	Enter your UUID.
EnableCASUseAuditor	Computer\ HKEY_LOCAL_MACHINE /SOFTWARE/ Citrix/ SmartAuditor/ Server/	REG_DWORD	1

3. Restart the following services:

- Citrix Session Recording Analytics Service
- Citrix Session Recording Storage Manager

Dynamic session recording

December 3, 2024

Previously, session recording started strictly at the very beginning of sessions that met the recording policies and stopped strictly when those sessions ended.

Starting with the 7.18 release, Citrix introduces the dynamic session recording feature. With this feature, you can start or stop recording a specific session or sessions that a specific user launches, at any time during the sessions.

Note:

To make the feature work as expected, upgrade Session Recording, VDA, and Delivery Controller to Version 7.18 or later.

Enable or disable dynamic session recording

On the Session Recording agent, a registry value is added for enabling or disabling the feature. The registry value is set to **1** by default, which means that the feature is enabled by default.

To enable or disable the feature, complete the following steps:

1. After the Session Recording installation is complete, log on as an administrator to the machine where you installed the Session Recording agent.
2. Open the Registry Editor.
3. Browse to `HKEY_LOCAL_MACHINE\SOFTWARE\Citrix\SmartAuditor`.
4. Set the value of **DynamicControlAllowed** to **0** or use the default value, **1**.
 - 1**: enable dynamic recording
 - 0**: disable dynamic recording
5. Restart the Session Recording agent to make your setting take effect.
If you are using MCS or PVS for deployment, change the setting on your master image and perform an update to make your change take effect.

Warning:

Incorrectly editing the registry can cause serious problems that might require you to reinstall your operating system. Citrix cannot guarantee that problems resulting from the incorrect use of the Registry Editor can be solved. Use the Registry Editor at your own risk. Be sure to back up the registry before you edit it.

Dynamically start or stop recording by using PowerShell commands in the Citrix SDKs

You can use the dynamic session recording feature in both on-premises and Citrix Cloud environments. To use the feature in an on-premises environment, use the Citrix Virtual Apps and Desktops PowerShell SDK. To use the feature in a Citrix Cloud environment, use the Citrix DaaS Remote PowerShell SDK (formerly Citrix Virtual Apps and Desktops Remote PowerShell SDK).

To determine which SDK to install and use, be aware of the Delivery Controller that you specified when creating your recording policy. If you select the **Citrix Cloud Controller** check box to record sessions in a Citrix Cloud environment, you must validate your Citrix Cloud credentials.

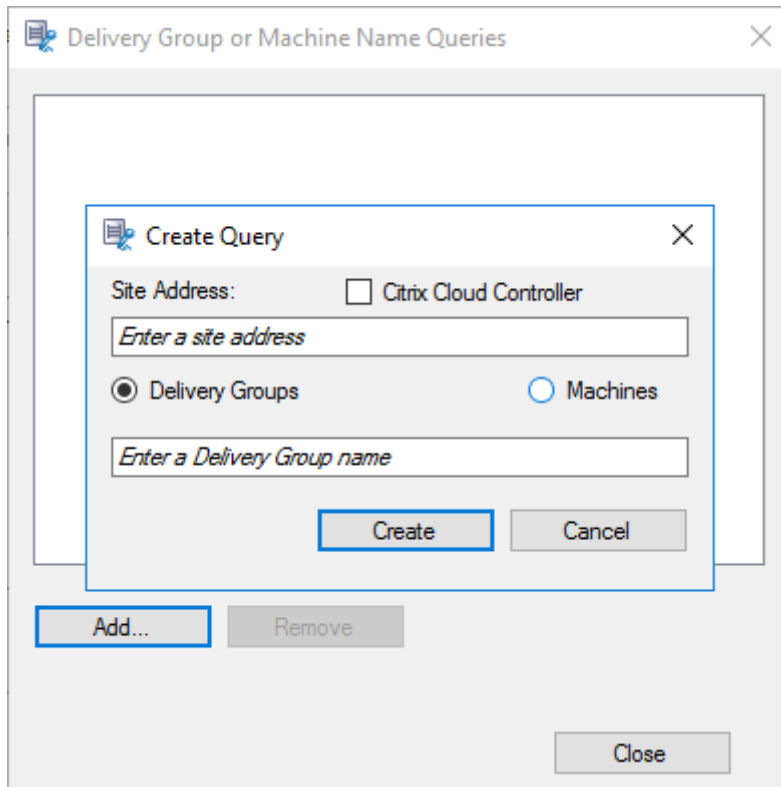

Note:

Do not install the Citrix DaaS Remote PowerShell SDK on a Citrix Cloud Connector machine. You can install the Remote PowerShell SDK on any domain-joined machine within the same resource location. We recommend that you do not run this SDK’s cmdlets on Cloud Connectors. The SDK’s operation does not involve the Cloud Connectors.

The following table lists three PowerShell commands that both Citrix SDKs provide for dynamic session recording.

Command	Description
Start-BrokerSessionRecording	Lets you start recording a specific active session, a list of active sessions, or sessions launched by a specific user. If a specific session is originally set up for an event-only recording according to policy settings, using this command allows you to start capturing the screen in addition to the target events. For more information, run Get-Help Start-BrokerSessionRecording to see the command online help.

Command	Description
Stop-BrokerSessionRecording	Lets you stop recording a specific active session, a list of active sessions, or sessions launched by a specific user. For more information, run Get-Help Stop-BrokerSessionRecording to see the command online help.
Get-BrokerSessionRecordingStatus	Lets you get the recording status of a specific active session. For more information, run Get-Help Get-BrokerSessionRecordingStatus to see the command online help.

For example, when a user reports an issue and needs timely support, you can use the feature to dynamically start recording the user’s active sessions. You can play the live recording to proceed with the follow-up troubleshooting. You can do the following:

1. (For Citrix Virtual Apps and Desktops PowerShell SDK only) Launch PowerShell from the Citrix Studio console.

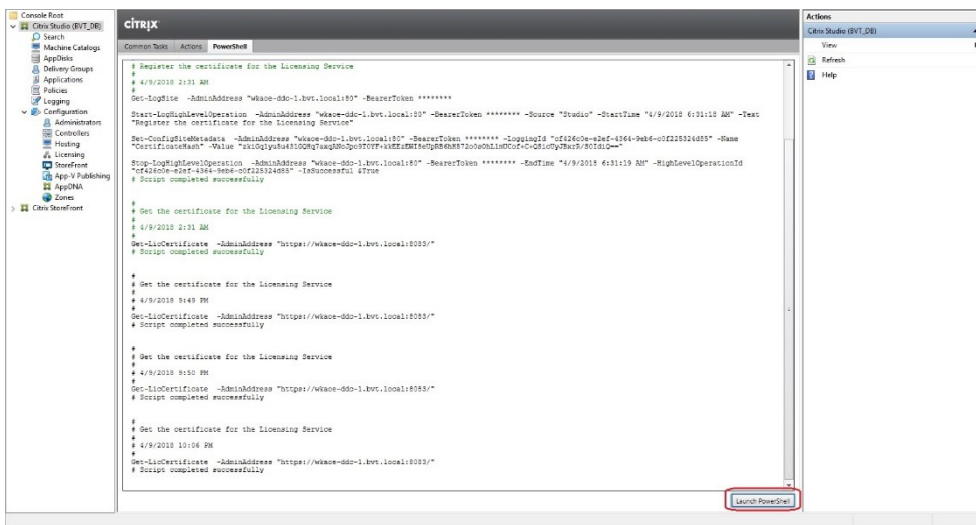

2. Use the `Get-BrokerSession` command to get all the active sessions of the target user.

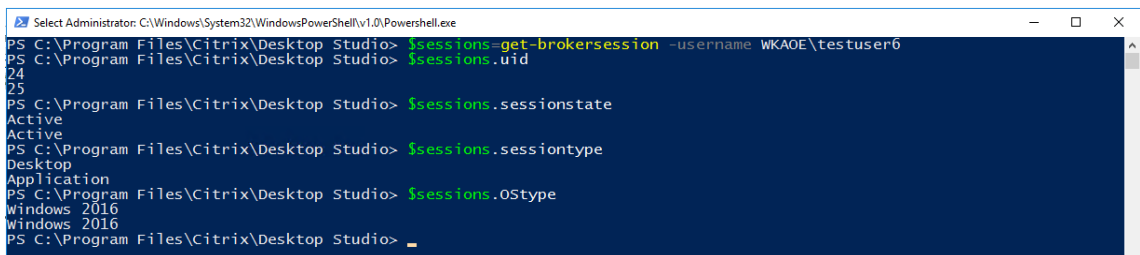

- Use the `Get-BrokerSessionRecordingStatus` command to get the recording status of the specified session.

```
PS C:\Program Files\Citrix\Desktop Studio> Get-BrokerSessionRecordingStatus -Session 24
SessionNotRecorded
PS C:\Program Files\Citrix\Desktop Studio> Get-BrokerSessionRecordingStatus -Session 25
SessionNotRecorded
PS C:\Program Files\Citrix\Desktop Studio> _
```

Note:

The **-Session** parameter can accept only one session UID at a time.

- Use the `Start-BrokerSessionRecording` command to start recording. By default, a notification message appears to inform users of the recording activity.

The following table shows common ways of using the `Start-BrokerSessionRecording` command.

Command	Description
<code>Start-BrokerSessionRecording - User DomainA \ UserA</code>	Starts recording all sessions of user UserA in the domain named DomainA and notifies UserA.
<code>Start-BrokerSessionRecording - User DomainA \ UserA -NotifyUser \$false</code>	Starts recording all sessions of user UserA in the domain named DomainA and does not notify UserA.
<code>Start-BrokerSessionRecording - Sessions \$SessionObject</code>	Starts recording all sessions in the object named \$SessionObject and notifies the user. To get the object \$SessionObject, run <code>\$SessionObject=Get-BrokerSession -username UserA</code> . The name of an object is prefixed with a dollar sign \$. For more information, see Step 2 and the command online help.
<code>Start-BrokerSessionRecording - Sessions uid1,uid2,...,uidn</code>	Starts recording the sessions UID1, UID2, ..., and UIDn, and notifies the users.

- Use the `Get-BrokerSessionRecordingStatus` command to get the recording status of each target session. The status is supposed to be **SessionBeingRecorded**.
- Play back the **Live** or **Complete** recordings and proceed with the follow-up troubleshooting.

Note □

When you play a **Complete** recording ended by the `Stop-BrokerSessionRecording` command, the last section of the timeline on the player progress bar might show gray. And,

the last section of the recorded session is idle. It is not obvious when the recorded session has constant activities.

7. Use the `Stop-BrokerSessionRecording` command to stop recording when the reported issue has been triaged or resolved.

The following table shows common ways of using this command:

Command	Description
<code>Stop-BrokerSessionRecording -User DomainA\UserA</code>	Stops recording all sessions of user UserA in the domain named DomainA.
<code>Stop-BrokerSessionRecording -Sessions \$SessionObject</code>	Stops recording all sessions in the \$SessionObject.
<code>Stop-BrokerSessionRecording -Sessions uid1,uid2,...,uidn</code>	Stops recording the sessions UID1, UID2, ..., and UIDn.

On the Citrix Studio **Logging** screen, you can view the resulting logs of the `Start-BrokerSessionRecording` and `Stop-BrokerSessionRecording` commands.

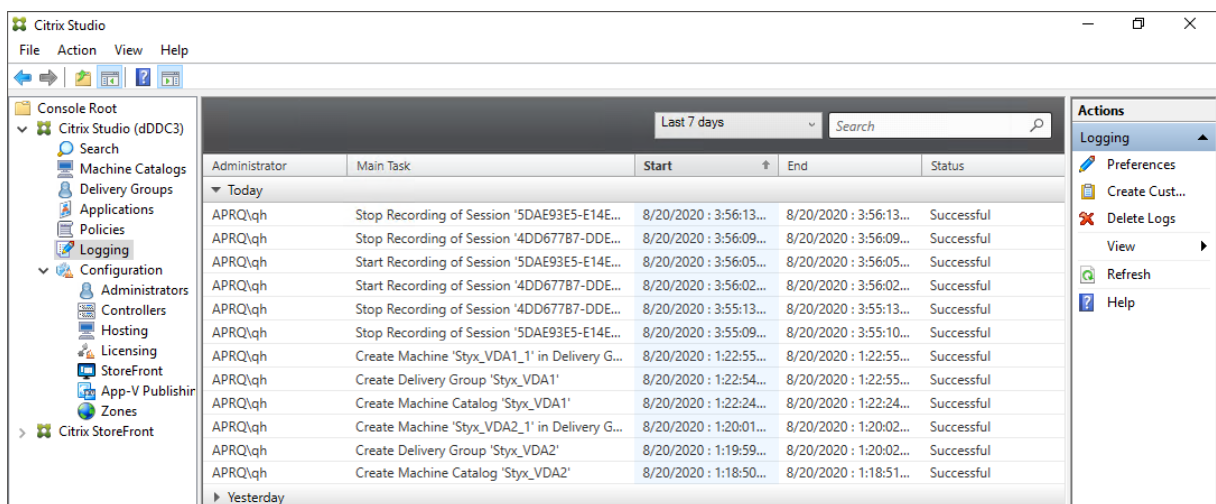

Configure

December 3, 2024

This section provides instructions for you to configure the following settings:

- [Settings on the Session Recording agent](#)

- [Enable or disable recording](#)
- [Configure the connection to the Session Recording Server](#)
- [Configure the communication protocol](#)
- [Settings on the Session Recording server](#)
 - [Authorize users](#)
 - [Customize recording notification messages](#)
 - [Specify where recordings are stored](#)
 - [Specify file size for recordings](#)
 - [Enable or disable digital signing](#)
 - [CEIP and Google Analytics](#)
- [Policies](#)
 - [Configure session recording policies](#)
 - [Configure recording viewing policies](#)
 - [Configure event detection policies](#)
 - [Configure event response policies](#)
- [High availability and load balancing](#)
 - [Load balance Session Recording servers](#)
 - [Configure database high availability](#)

Configure settings on the Session Recording agent

December 3, 2024

This section guides you through the following settings:

- [Enable or disable recording](#)
- [Configure the connection to the Session Recording Server](#)
- [Configure the communication protocol](#)

Enable or disable recording

December 3, 2024

You can install the Session Recording agent on both multi-session OS and single-session OS VDAs for recording sessions hosted on those VDAs. Within each agent is a setting that enables recording for

the VDA on which it is installed. After recording is enabled, Session Recording evaluates the active recording policy that determines which sessions are recorded.

We recommend you disable session recording on VDAs that are not recorded. There is a small impact on performance, even if no recording takes place.

Enable or disable recording on a VDA

1. Log on to the server where the Session Recording agent is installed.
2. From the **Start** menu, choose **Session Recording Agent Properties**.
3. Under **Session Recording**, select or clear the **Enable session recording for this VDA machine** check box to specify whether sessions can be recorded for this VDA.

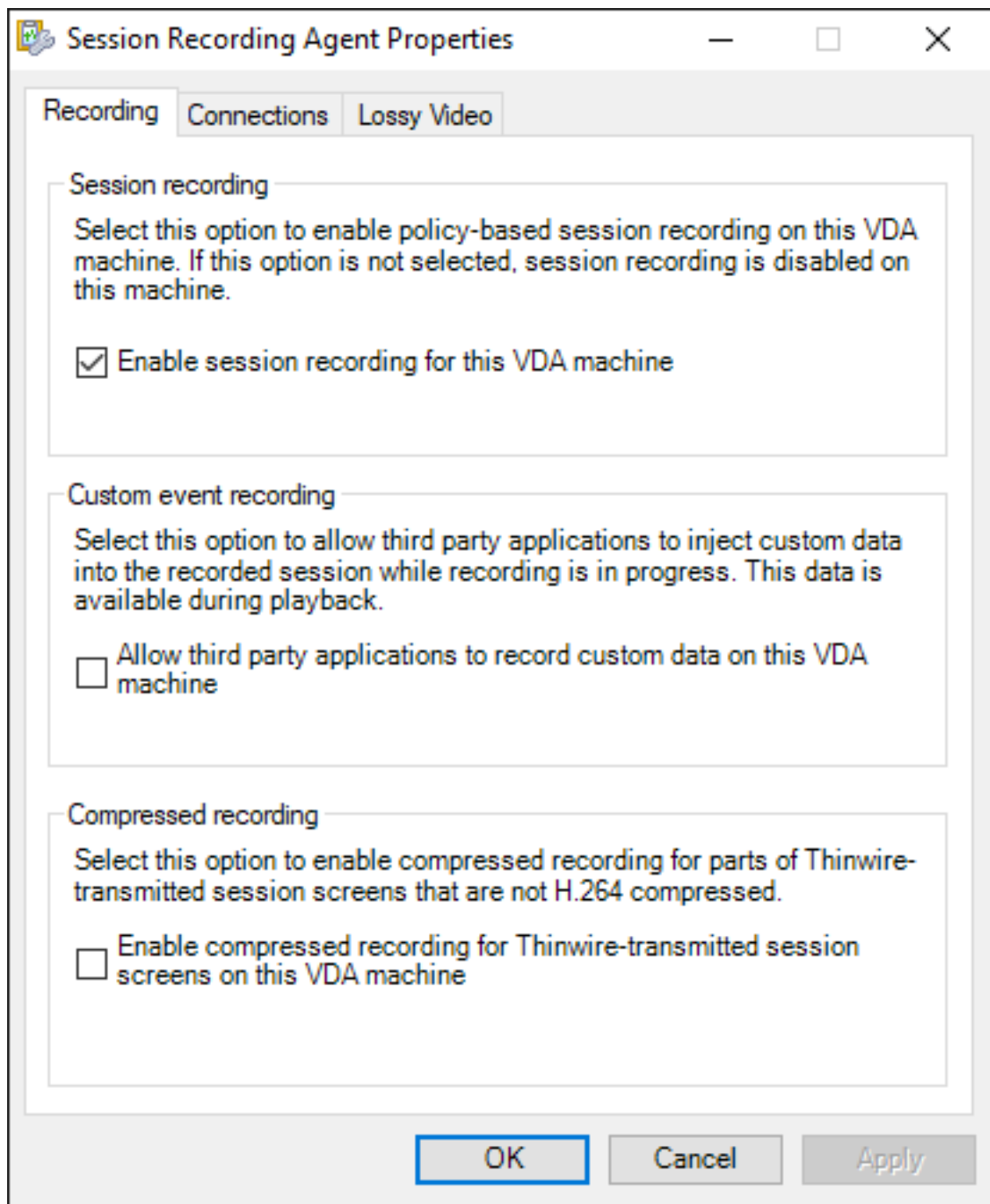

4. When prompted, restart the Session Recording agent service to accept the change.

Note:

When you install Session Recording, the active policy is

Do not record (no sessions are recorded on any server). To begin recording, use the Session Recording policy console to activate a different policy.

Enable custom event recording

Session Recording allows you to use third-party applications to insert custom data, known as events, to recorded sessions. These events appear when the recorded session is played back. Events are part of the recorded session file and can't be modified after the session is recorded.

For example, an event might contain the following text: "User opened a browser." Each time a user opens a browser during a session being recorded, the text inserts to the recording at that point. When a viewer plays back the recorded session, the viewer can locate and count the times that the user opened a browser by noting the number of markers.

To insert custom events to recordings on a server:

- Use **Session Recording Agent Properties** to enable a setting on each server where you want to insert custom events. Enable each server separately. You can't globally enable all servers in a site.
- Write applications built on the Event API that runs within each user's virtual session, to inject the data into the recording.

The Session Recording installation includes an event recording COM application (API) that allows you to insert text from third-party applications to a recording. You can use the API from many programming languages including Visual Basic, C++, or C#. For more information, see the Knowledge Center article [CTX226844](#). The Session Recording Event API .dll is installed as part of the Session Recording installation. You can find it at `C:\Program Files\Citrix\SessionRecording\Agent\Bin\Interop.UserApi.dll`.

To enable custom event recording on a server, complete the following steps:

1. Log on to the server where the Session Recording agent is installed.
2. From the **Start** menu, choose **Session Recording Agent Properties**.
3. In **Session Recording Agent Properties**, click the **Recording** tab.
4. Under **Custom event recording**, select the **Allow third party applications to record custom data on this server** check box.

Enable compressed recording

You can enable compressed recording for parts of Thinwire-transmitted session screens that are not H.264 compressed. This feature reduces recording file size significantly.

Note:

- This feature is disabled by default.

- This feature is incompatible with the [H.264 package dropping feature](#).
- The minimum version required for the VDA is 2303.

To enable compressed recording, complete the following steps:

1. Log on to the server where the Session Recording agent is installed.
2. From the **Start** menu, choose **Session Recording Agent Properties**.
3. In **Session Recording Agent Properties**, click the **Recording** tab.
4. Under **Compressed recording**, select the **Enable compressed recording for Thinwire-transmitted session screens on this VDA machine** check box.

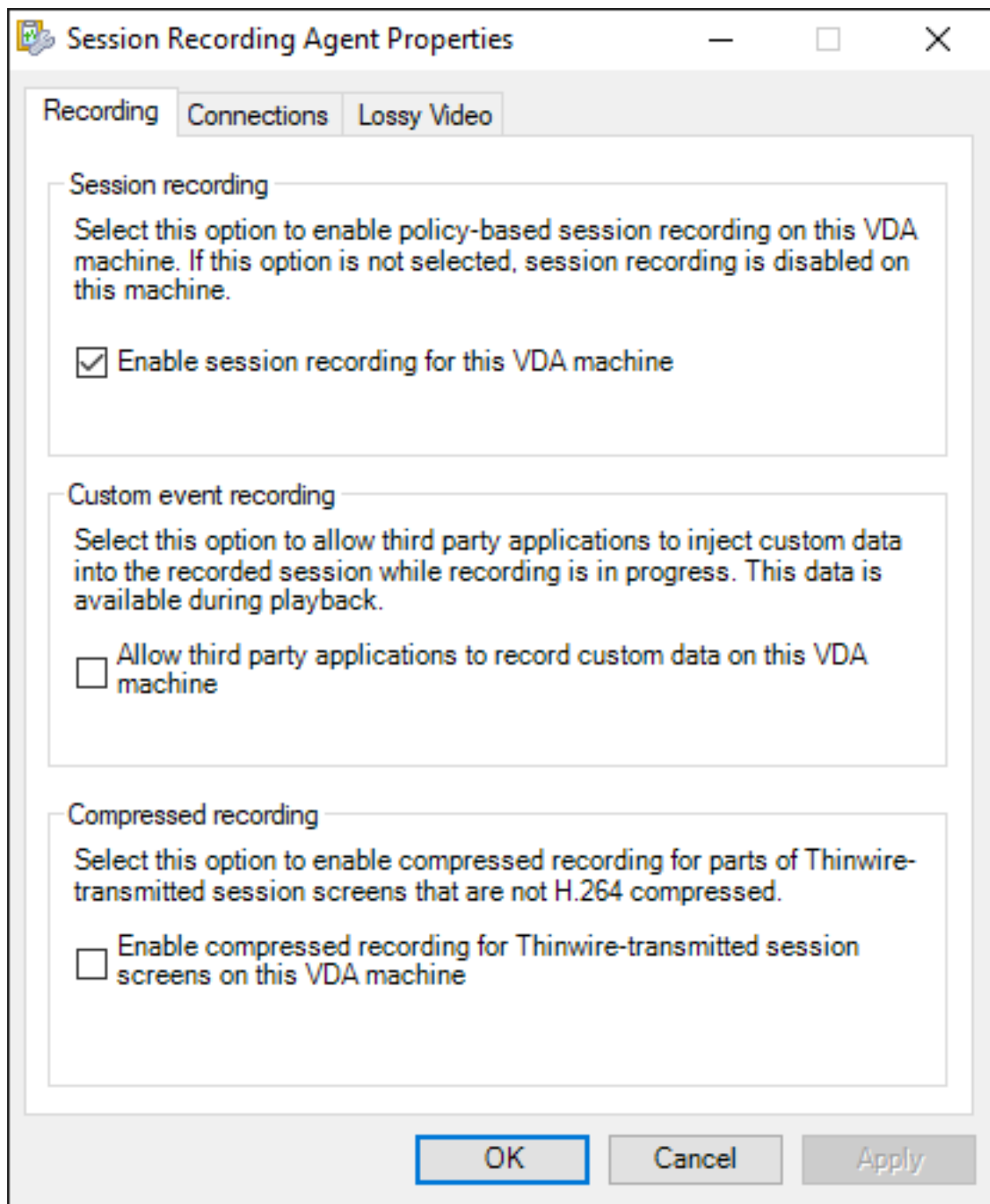

Enable or disable lossy screen recording

December 3, 2024

Lossy screen recording lets you adjust compression options to reduce the size of recording files and to accelerate navigating recorded sessions during playback. Lossy screen recording is suitable for use

when:

- the size of recording files per time unit is too large, or
- there is a lag while you fast forward or rewind during recording playback.

You can now enable lossy screen recording in any of the following ways:

- Activate a system-defined session recording policy that has lossy screen recording enabled.
- Create and activate a custom session recording policy, and make sure to select **Enable lossy screen recording** when creating the custom policy.
- Select **Enable lossy screen recording** when configuring an event response policy. When a monitored event is detected later, lossy screen recording is triggered.

For more information, see [Configure session recording policies](#) and [Configure event response policies](#).

When the active session recording or event response policy doesn't have lossy screen recording enabled, compression options are unavailable.

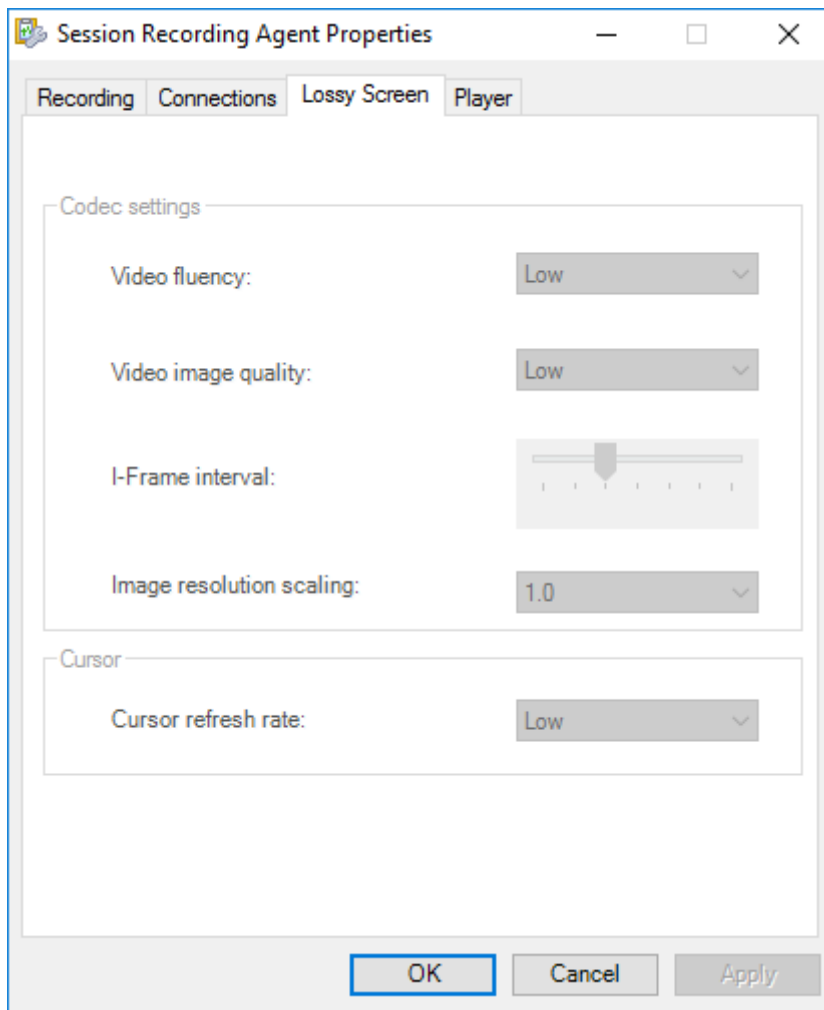

When the active session recording or event response policy has lossy screen recording enabled, compression options are available on the **Lossy Screen** tab of **Session Recording Agent Properties**.

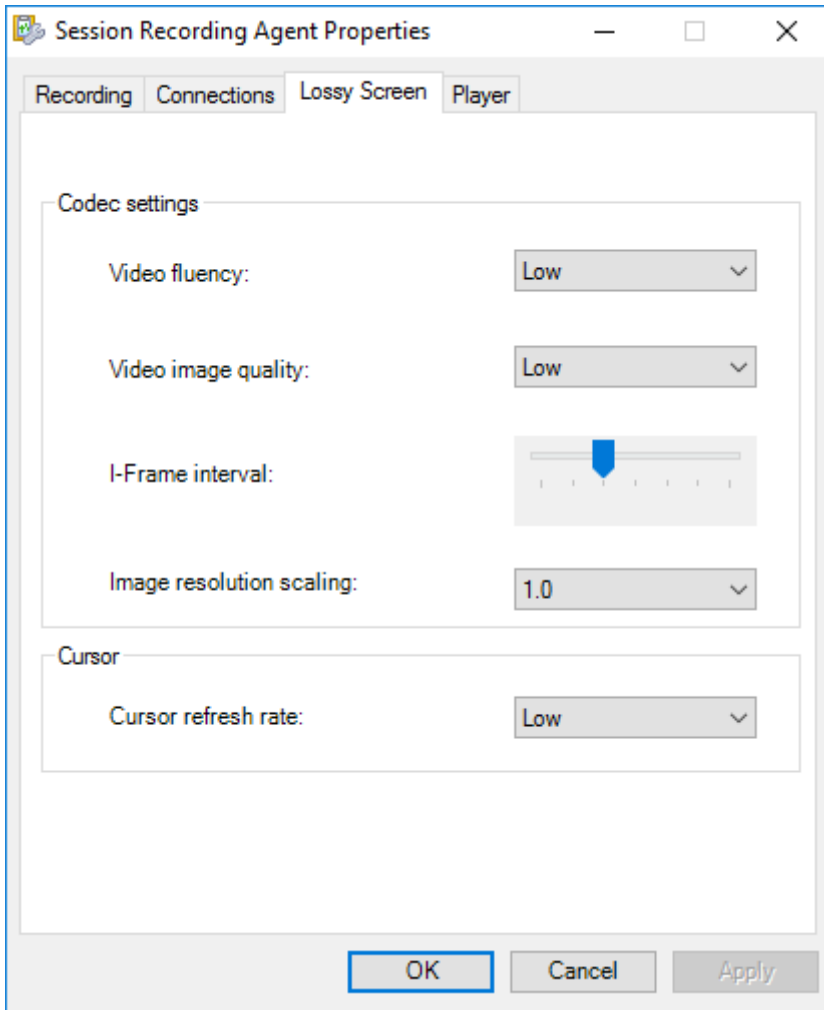

You can adjust the compression options to your needs. We recommend you use the default values unless there is a practical need to change the values.

For a description of compression options, see the following table:

Compression option	Description	Default value	Remarks
Video fluency (FPS)	Low: 1; Medium: 5; High: 10	Low	N/A

Compression option	Description	Default value	Remarks
Video image quality	Low: <code>bitrate:140</code> (kbps); Medium: <code>bitrate:280</code> (kbps); High: <code>bitrate:420</code> (kbps)	Low	Session Recording uses Average Bitrate (ABR) for video bitrate encoding. Higher values mean less compression. You can also set a custom value between 40 kbps and 80,000 kbps by editing the Registry at <code>HKEY_LOCAL_MACHINE\SOFTWARE</code>
I-Frame interval (seconds)	60, 120, 300, 600, 1200, 1800, 3600	600	The larger the I-Frame interval value, the smaller the storage space occupied by the compressed video. The smaller the I-Frame interval value, the better the seeking experience (fast forward and rewind). You can downscale the resolution of recorded screens to a percentage, for example, 0.9 means 90% . If you don't want to change the resolution, use the default value 1.0 . You can also set the image resolution scaling by editing the Registry at <code>HKEY_LOCAL_MACHINE\SOFTWARE</code>
Image resolution scaling	1.0, 0.9, 0.8, 0.7, 0.6, 0.5, 0.4	1	N/A
Cursor refresh rate (times per second)	Low: 3; Medium: 5; High: 10	Low	N/A

Enable fast seeking

December 3, 2024

Fast seeking allows to accelerate navigating ICA screen recordings during playback. It significantly improves the playback seeking experience.

Note:

Fast seeking is valid only for the sessions that are recorded after the feature is enabled in **Session Recording Agent Properties**.

Enable fast seeking

To enable fast seeking, complete the following steps:

1. Open the **Player** tab of **Session Recording Agent Properties**.
2. Select **Enable fast seeking** and configure how often an I-Frame is generated.

You can select a system-defined I-Frame interval or configure a custom I-Frame (in seconds, ranging from 10 to 1,800 seconds). By default, the system-defined I-Frame interval **Medium** (60 seconds) is selected.

For a description of the system-defined I-Frame intervals, see the following table:

System-defined I-Frame interval	Description
Low	300 seconds
Medium	60 seconds
High	30 seconds

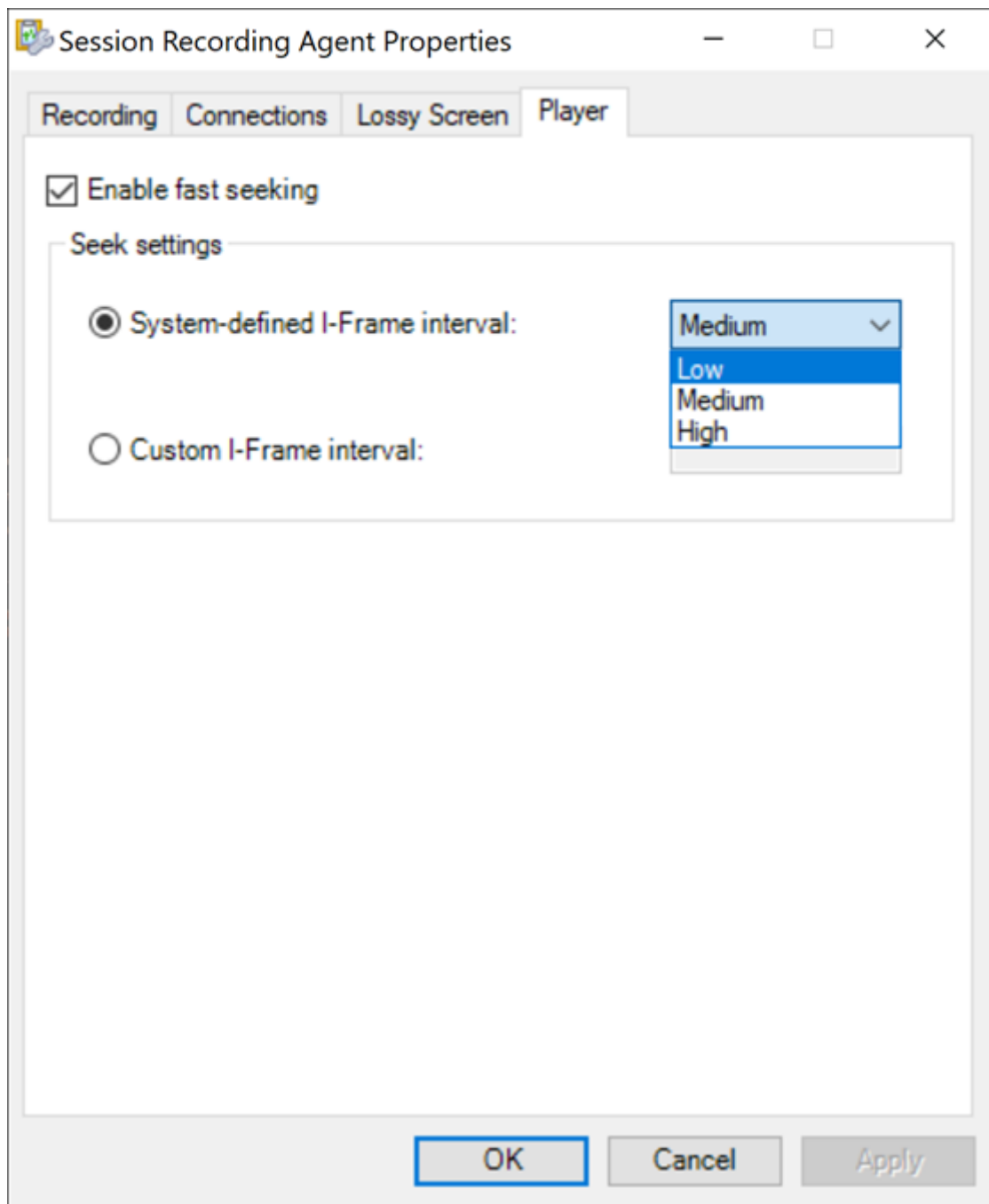

3. (Optional) If you also want to enable fast seeking for the Session Recording web player, navigate to **Configuration > Preferences** on the web player page and ensure that **Enable fast seeking** is selected.

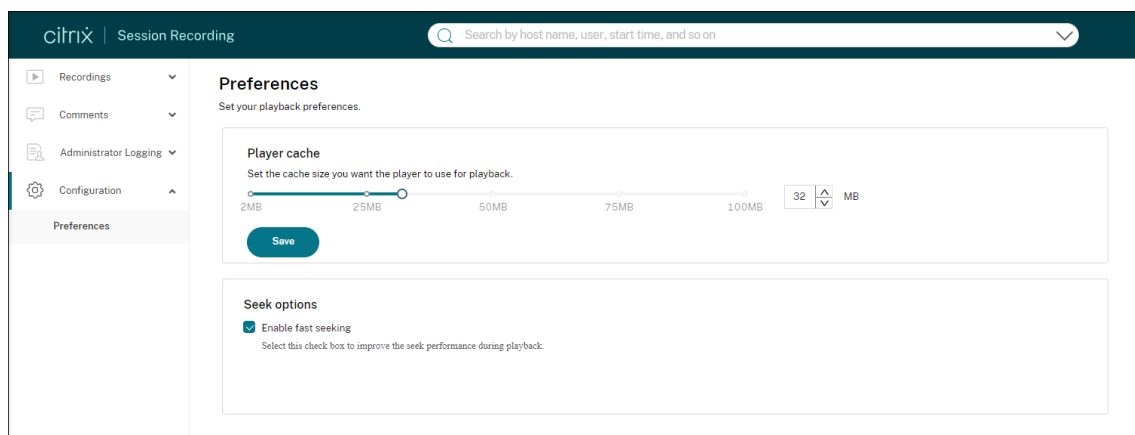

Configure the connection to the Session Recording server

December 3, 2024

Configure the connection of the Session Recording player to the Session Recording server

Before a Session Recording player can play sessions, configure it to connect to the Session Recording server that stores the recorded sessions. Each player can be configured with the ability to connect to multiple Session Recording servers, but can connect to only one Session Recording server at a time. If a player is configured with the ability to connect to multiple Session Recording servers, users can change which Session Recording server the player connects to.

1. Log on to the workstation where the Session Recording player is installed.
2. Start the Session Recording player.
3. From the Session Recording player menu bar, choose **Tools > Options**.
4. On the **Connections** tab, click **Add**.
5. In the **Hostname** field, type the name or IP address of the machine hosting the Session Recording server and select the protocol. By default, Session Recording is configured to use HTTPS/SSL to secure communications. If SSL is not configured, select HTTP.
6. To configure the Session Recording player with the ability to connect to multiple Session Recording servers, repeat Steps 4 and 5 for each Session Recording server.
7. Ensure that you select the check box of the Session Recording server you want to connect to.

Configure the connection of the Session Recording agent to the Session Recording server

The connection is typically configured when the Session Recording agent is installed. To configure this connection after the Session Recording agent is installed, use **Session Recording Agent Properties**.

1. Log on to the server where the Session Recording agent is installed.
2. From the **Start** menu, choose **Session Recording Agent Properties**.
3. Click the **Connections** tab.
4. In the **Session Recording Server** field, type the FQDN of the Session Recording server.

Note:

To use Message Queuing over HTTPS (TCP is used by default), type an FQDN in the **Session Recording Server** field. Otherwise, session recording fails.

5. In the **Session Recording Storage Manager message queue** section, select the protocol that is used by the Session Recording Storage Manager to communicate and change the default port number if necessary.

Note:

To use Message Queuing over HTTP and HTTPS, install all the IIS recommended features.

6. In the **Message life** field, accept the default 7,200 seconds (two hours) or type a new value for the number of seconds each message is retained in the queue if there is a communication failure. After this time elapses, the message is deleted and the file is playable until the point where the data is lost.
7. In the **Session Recording Broker** section, select the communication protocol that the Session Recording Broker uses to communicate and change the default port number if necessary.
8. When prompted, restart the Session Recording agent service to accept the changes.

Change your communication protocol

December 3, 2024

For security reasons, Citrix does not recommend using HTTP as a communication protocol. The Session Recording installation is configured to use HTTPS. To use HTTP instead of HTTPS, you must change several settings.

Use HTTP as the communication protocol

1. Log on to the machine hosting the Session Recording server and disable secure connections for Session Recording Broker in IIS.
2. Change the protocol setting from HTTPS to HTTP in **Session Recording Agent Properties** on each server where the Session Recording agent is installed:
 - a) Log on to each server where the Session Recording agent is installed.
 - b) From the **Start** menu, choose **Session Recording Agent Properties**.
 - c) In **Session Recording Agent Properties**, choose the **Connections** tab.
 - d) In the **Session Recording Broker** area, select **HTTP** from the **Protocol** drop-down list and click **OK** to accept the change. If you are prompted to restart the service, click **Yes**.
3. Change the protocol setting from HTTPS to HTTP in the Session Recording Player settings:
 - a) Log on to each workstation where the Session Recording Player is installed.
 - b) From the **Start** menu, choose **Session Recording Player**.
 - c) From the **Session Recording Player** menu bar, choose **Tools > Options > Connections**, select the server, and choose **Modify**.
 - d) Select **HTTP** from the **Protocol** drop-down list and click **OK** twice to accept the change and exit the dialog box.
4. Change the protocol setting from HTTPS to HTTP in the Session Recording policy console:
 - a) Log on to the server where the Session Recording policy console is installed.
 - b) From the **Start** menu, choose **Session Recording Policy Console**.
 - c) Select **HTTP** from the **Protocol** drop-down list and click **OK** to connect. If the connection is successful, this setting is remembered the next time you start the Session Recording policy console.

Revert to HTTPS as the communication protocol

1. Log on to the machine hosting the Session Recording server and enable secure connections for the Session Recording Broker in IIS.
2. Change the protocol setting from HTTP to HTTPS in **Session Recording Agent Properties** on each server where the Session Recording agent is installed:
 - a) Log on to each server where the Session Recording agent is installed.
 - b) From the **Start** menu, choose **Session Recording Agent Properties**.
 - c) In **Session Recording Agent Properties**, choose the **Connections** tab.
 - d) In the **Session Recording Broker** area, select **HTTPS** from the **Protocol** drop-down list and click **OK** to accept the change. If you are prompted to restart the service, click **Yes**.
3. Change the protocol setting from HTTP to HTTPS in the Session Recording Player settings:

- a) Log on to each workstation where the Session Recording Player is installed.
 - b) From the **Start** menu, choose **Session Recording Player**.
 - c) From the **Session Recording Player** menu bar, choose **Tools > Options > Connections**, select the server, and choose **Modify**.
 - d) Select **HTTPS** from the **Protocol** drop-down list and click **OK** twice to accept the change and exit the dialog box.
4. Change the protocol setting from HTTP to HTTPS in the Session Recording policy console:
- a) Log on to the server where the Session Recording policy console is installed.
 - b) From the **Start** menu, choose **Session Recording Policy Console**.
 - c) Select **HTTPS** from the **Protocol** drop-down list and click **OK** to connect. If the connection is successful, this setting is remembered the next time you start the Session Recording policy console.

Configure settings on the Session Recording server

December 3, 2024

This section guides you through the following settings:

- [Authorize users](#)
- [Customize recording notification messages](#)
- [Specify where recordings are stored](#)
- [Specify file size for recordings](#)
- [Enable or disable digital signing](#)
- [CEIP and Google Analytics](#)

Authorize users

December 3, 2024

To grant users the rights, you assign users to roles using the Session Recording Authorization Console on the Session Recording server. Five roles are available:

Important:

For security reasons, grant users only the rights they need to perform specific functions, such as viewing recorded sessions.

- **PolicyAdministrator.** Grants the right to view, create, edit, delete, and enable recording policies. By default, administrators of the machine hosting the Session Recording server are members of this role.
- **PolicyQuery.** Allows the servers hosting the Session Recording agent to request recording policy evaluations. By default, authenticated users are members of this role.
- **LoggingWriter.** Grants the right to write the Administrator Logging logs. By default, local administrators and the Network Service group are members of this role. Changing the default **LoggingWriter** membership can cause log writing failure.
- **LoggingReader.** Grants the right to query the Administrator Logging logs. There is no default membership in this role.
- **PrivilegedPlayer.** Grants the right to place and remove access restrictions on recordings and the right to archive and delete recordings.
- **Player.** Grants the right to view recorded Citrix Virtual Apps and Desktops and Citrix DaaS (formerly Citrix Virtual Apps and Desktops service) sessions. There is no default membership in this role. When you install Session Recording, no user has the right to play recorded sessions. A user without the permission to play recorded sessions receives the following error message when trying to play a recorded session:

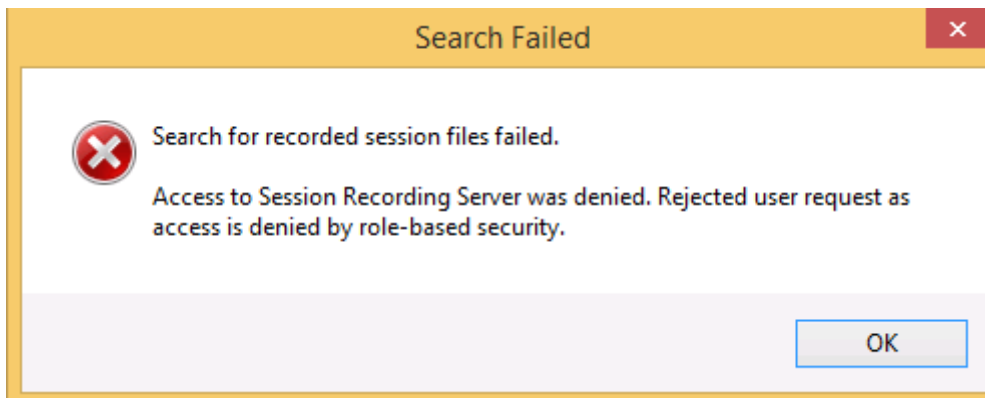

To assign users to a role, do the following:

1. Log on as an administrator to the machine hosting the Session Recording server.
2. Start the Session Recording Authorization Console.
3. Select the role to which you want to assign users.
4. From the menu bar, choose **Action > Assign Users and Groups**.
5. Add the users and groups.

Session Recording supports users and groups defined in the Active Directory.

Any changes made to the console take effect during the update that occurs once every minute. Also, starting with the 1906 release, you can use the Session Recording policy console to create recording viewing policies. For more information, see [Recording viewing policies](#).

CEIP and Google Analytics

December 3, 2024

When you participate in the Citrix Customer Experience Improvement Program (CEIP), anonymous configuration and usage data is collected and sent to Citrix. The data helps improve the product quality and performance. In addition, a copy of the anonymous data can be sent to Google Analytics for fast and efficient analysis.

CEIP setting

By default, you automatically participate in CEIP when you install Session Recording. The first upload of data occurs approximately seven days after you install Session Recording. To unsubscribe from CEIP, do the following:

1. Log on to the machine hosting the Session Recording server.
2. From the **Start** menu, choose **Session Recording Server Properties**.
3. In **Session Recording Server Properties**, click the **CEIP** tab.
4. Clear the **Participate in the Customer Experience Improvement Program** check box.
5. Restart the **Citrix Session Recording Analytics Service** for the setting to take effect.

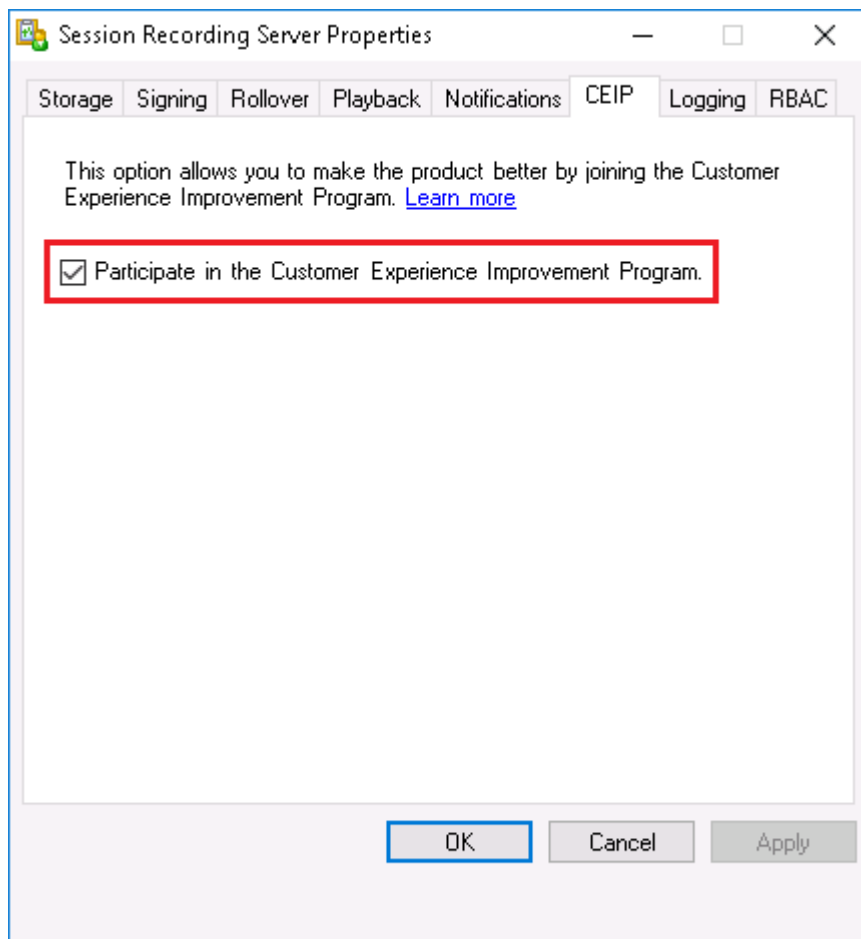

Google Analytics setting

When Google Analytics is enabled, the heartbeat data between Google Analytics and the Session Recording server is collected every 5 hours. User behavior data on the web player is also sent to Google Analytics. User behavior includes activities such as opening the web player and playing or searching recordings in it.

Google Analytics is enabled by default, except for EU customers. If the time zone or region you selected when installing Session Recording belong to the EU, you are considered an EU customer and Google Analytics is disabled for you by default.

Registry setting that enables or disables Google Analytics:

Location: HKEY_LOCAL_MACHINE\SOFTWARE\Citrix\SmartAuditor\Server\

Name: CeipHeartBeatDisable

Value: 1 = disabled, 0 = enabled

To disable Google Analytics, complete the following steps:

1. Log on to the machine hosting the Session Recording server.
2. Open the **Registry Editor**.
3. Browse to `HKEY_LOCAL_MACHINE\SOFTWARE\Citrix\SmartAuditor\Server\`.
4. Locate or add the registry value **CeipHeartBeatDisable**.
5. Set the value data of **CeipHeartBeatDisable** to 1.
6. Restart the Citrix Session Recording Analytics Service for the setting to take effect.

To enable Google Analytics, complete the following steps:

1. Log on to the machine hosting the Session Recording server.
2. Open the Registry Editor.
3. Browse to `HKEY_LOCAL_MACHINE\SOFTWARE\Citrix\SmartAuditor\Server\`.
4. Remove the registry value **CeipHeartBeatDisable** or set its value data to 0.
5. Restart the Citrix Session Recording Analytics Service to make for the setting to take effect.

Data collected from the Session Recording server

The following table gives an example of the types of anonymous information collected. The data does not contain any details that identify you as a customer.

Data Point	Key Name	Description
Machine GUID	<code>machine_guid</code>	Identifying the machine where the data originates. With Google Analytics enabled, heartbeat data is sent to Google Analytics regardless of whether CEIP is enabled.
Operating System version	<code>OS_version</code>	Text string denoting the machine's operating system. With Google Analytics enabled, heartbeat data is sent to Google Analytics regardless of whether CEIP is enabled.

Data Point	Key Name	Description
Session Recording server version	<code>SRS_version</code>	Text string denoting the installed version of the Session Recording server. With Google Analytics enabled, heartbeat data is sent to Google Analytics regardless of whether CEIP is enabled.
Number of application recordings	<code>application-recording-number</code>	Integer denoting the number of application recording files. The data is sent when both Google Analytics and CEIP are enabled.
Number of recordings	<code>recording-number</code>	Integer denoting the number of both application and desktop recording files. The data is sent when both Google Analytics and CEIP are enabled.
Number of dynamic recordings	<code>dynamic-recording-number</code>	Integer denoting the number of dynamically recorded files. The data is sent when both Google Analytics and CEIP are enabled.
Number of agents hosting recorded sessions	<code>recorded-agent-number</code>	Integer denoting the number of VDAs hosting recorded sessions. The data is sent when both Google Analytics and CEIP are enabled.
Number of agents hosting recorded sessions containing logged events	<code>event-logging-enabled-agent-number</code>	Integer denoting the number of VDAs hosting recorded sessions that contain logged events. The data is sent when both Google Analytics and CEIP are enabled.
Number of recordings containing logged events	<code>event-logging-recording-number</code>	Integer denoting the number of recording files that contain logged events. The data is sent when both Google Analytics and CEIP are enabled.

Data Point	Key Name	Description
Administrator logging enablement	<code>admin-logging-status</code>	Digit indicating the enablement of administrator logging. “1” means enabled. “0” means disabled. The data is sent when both Google Analytics and CEIP are enabled.
Number of logged events	<code>collected-events-number</code>	Integer denoting the number of logged events. The data is sent when both Google Analytics and CEIP are enabled.
Number of custom policies	<code>customized-policies-number</code>	Integer denoting the number of custom session recording and event logging policies. The data is sent when both Google Analytics and CEIP are enabled.
Load balancing enablement	<code>load-balancing-status</code>	Digit indicating the enablement of load balancing. “1” means enabled. “0” means disabled. The data is sent when both Google Analytics and CEIP are enabled.
Recording viewing policy enablement	<code>rbac-status</code>	Digit indicating the enablement of recording viewing policies. “1” means enabled. “0” means disabled. The data is sent when both Google Analytics and CEIP are enabled.

Customize recording notification messages

December 3, 2024

If the active recording policy records sessions with notifications, users receive recording notifications after typing credentials.

- When **Allow end user to deny recording of their session** is enabled on the **Notifications** tab of

the **Session Recording Server Properties**, the default notification message reads as follows:

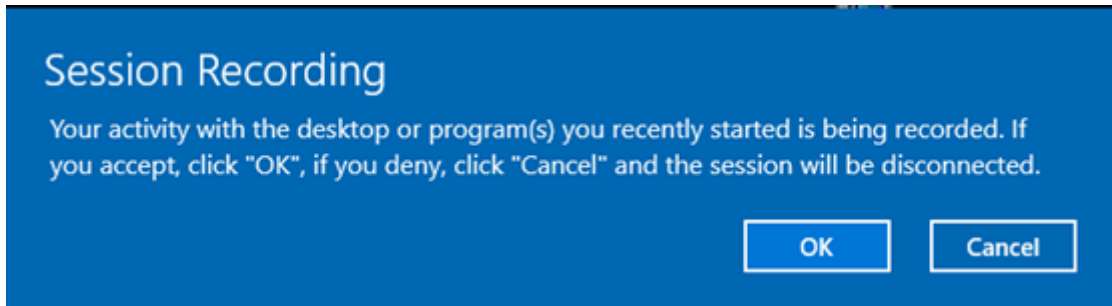

Allow end user to deny recording of their session. This feature forces end users to explicitly consent to the session recording disclaimer before they can continue with their session. If end users accept the disclaimer, their session continues with session recording enabled. If end users deny the disclaimer, their session is terminated.

- When **Allow end user to deny recording of their session** is not enabled, the default notification message is **Your activity with the desktop or program(s) you recently started is being recorded. If you object to this condition, close the desktop or program(s).** Users can click **OK** to dismiss the window and continue their sessions.

The default notification message appears in the language of the operating system on the VDA. You can change the default message title and message body as needed.

You can also create notification messages in specific languages that you choose. While doing so, you can customize the message title and message body too. You can have only one notification message for each language. Your users see notification messages in the languages of their preferred local settings. The language-specific notification messages take precedence over the default notification message.

Customize recording notification messages

1. Log on to the machine hosting the Session Recording server.
2. From the **Start** menu, choose **Session Recording Server Properties**.
3. In **Session Recording Server Properties**, click the **Notifications** tab.

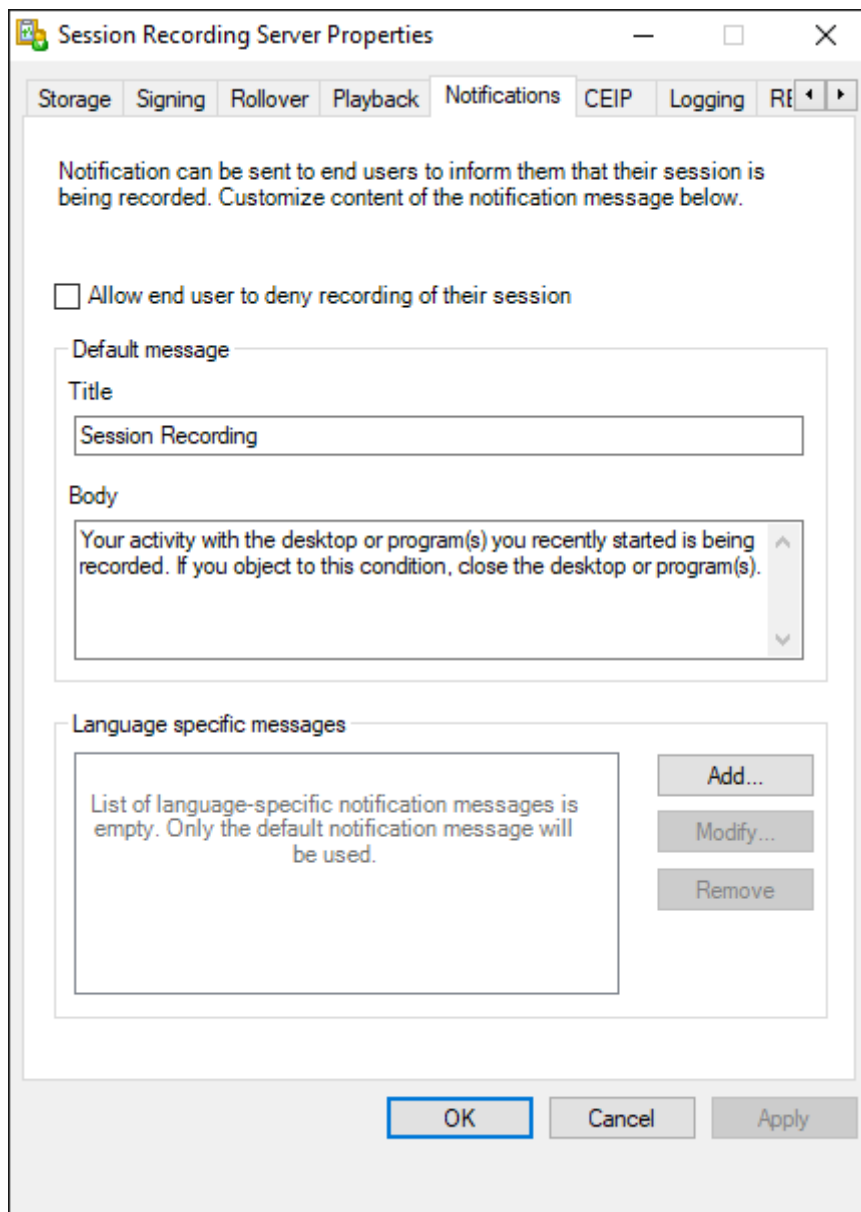

4. To enable explicit user consent before recording sessions, select **Allow end user to deny recording of their session**.

After you select **Allow end user to deny recording of their session**, the default message body changes accordingly:

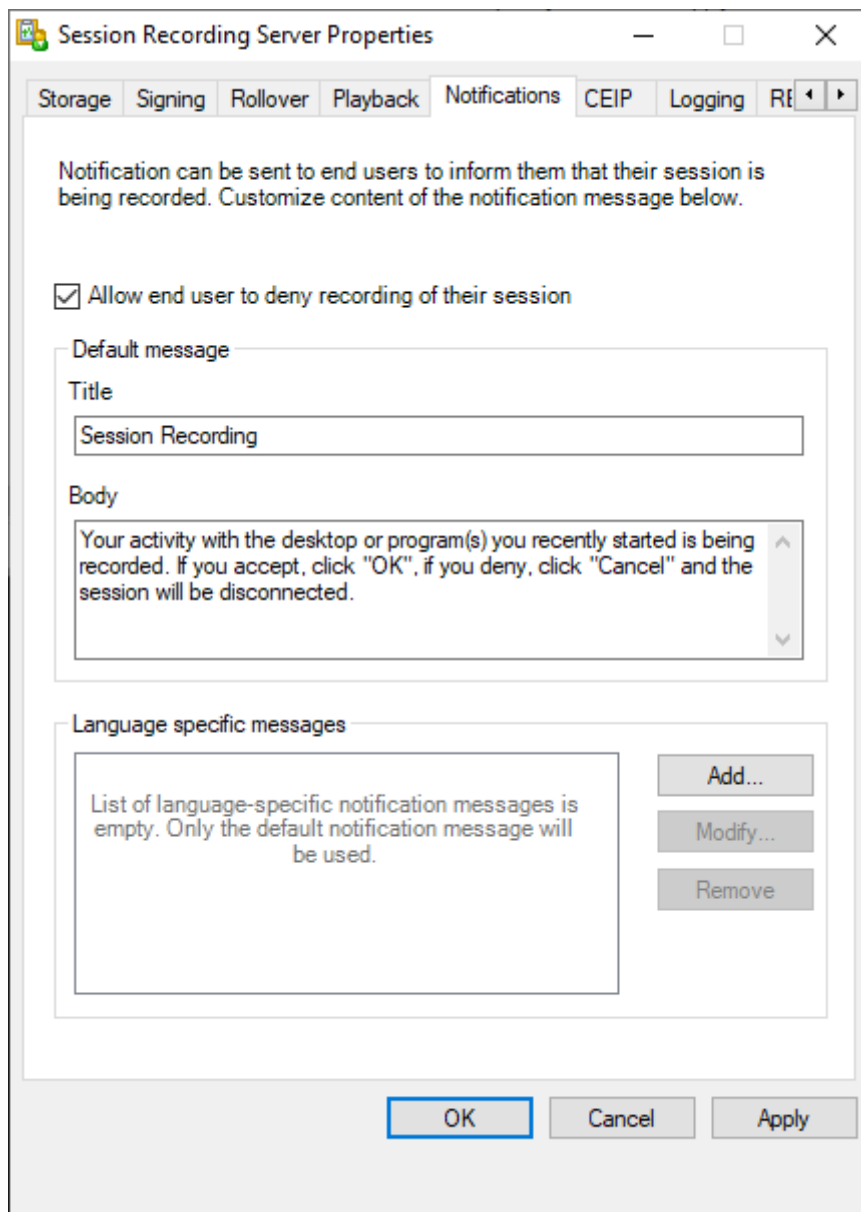

5. If you want to use the default notification message, change the default message title and message body as needed and then click **OK** to complete the settings. If you want to use a language-specific notification message, proceed to the following steps.
6. Click **Add** in the **Language specific messages** section.
7. Choose the language for the message and type the message title and message body. You can create only one message for each language.

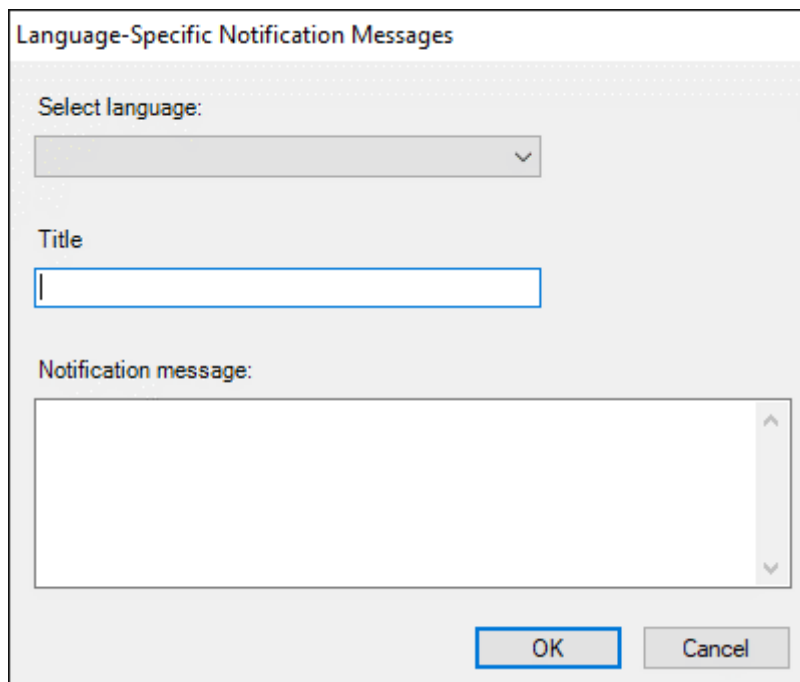

After accepting and activating, the new message appears in the language-specific notification message box.

Enable or disable digital signing

December 3, 2024

You can install certificates on machines where you installed the Session Recording server and the Session Recording player. Doing so can enhance the security of your deployment by assigning digital signatures to Session Recording.

By default, digital signing is disabled. After you select the certificate to sign the recordings, Session Recording grants the read permission to the Session Recording Storage Manager Service.

Enable digital signing

1. Log on to the machine hosting the Session Recording server.
2. From the **Start** menu, choose **Session Recording Server Properties**.
3. In **Session Recording Server Properties**, click the **Signing** tab.
4. Browse to the certificate that enables secure communication among the machines where you installed the Session Recording components.

Disable digital signing

1. Log on to the machine hosting the Session Recording server.
2. From the **Start** menu, choose **Session Recording Server Properties**.
3. In **Session Recording Server Properties**, click the **Signing** tab.
4. Click **Clear**.

Event response reports

December 3, 2024

Overview

You can receive emailed event response reports on a daily or weekly basis. An event response report contains a digest chart as the email body and a csv file as the attachment. The csv file includes a full list of the events during the day or week that have triggered various event responses.

Note:

By selecting email notifications as the event response in your custom event response policy, you can still be notified about each **individual** occurrence. You can choose regular event response reports, individual notifications, or both.

The following are example digest charts contained in a weekly and a daily event response report:

Weekly

Daily



Session Recording Event Response Report

Aug 7 - Aug 13, 2023

Statistics on responses triggered by your event response policy.

Database instance name: sessionrecording-db

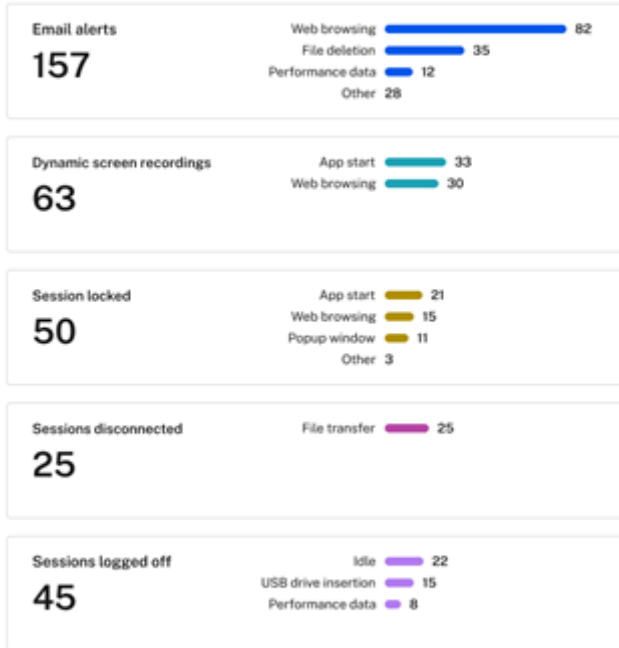

You can find the full list of events and responses attached to this email.

This is an automated email from Citrix Session Recording. Do not reply.



Session Recording Event Response Report

Aug 8, 2023

Statistics on responses triggered by your event response policy.

Database instance name: sessionrecording-db

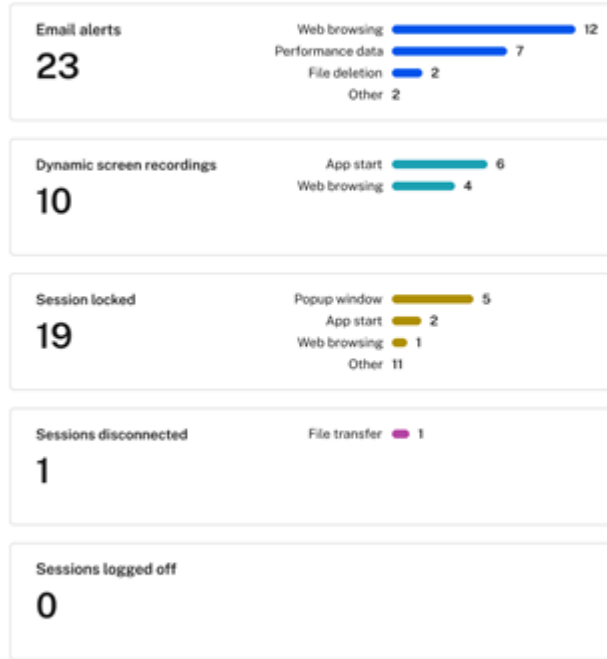

You can find the full list of events and responses attached to this email.

This is an automated email from Citrix Session Recording. Do not reply.

See the screen capture below for an example csv file that can be linked to an event response report:

← EventResponses_9_21_2023.csv Open with ▾

	A	B	C	D	E	F	G
1	User	Trigger time	Trigger description	Recording file	Trigger type	Trigger detail	Event detail
2	XF4B5\Administrator	9/20/2023 3:21:50 A		C:\SessionRecordings\2023\09\19\i_fab04	Session Start	Email alert when a s	Session Start
3	XF4B5\Administrator	9/20/2023 3:26:53 A	perf	C:\SessionRecordings\2023\09\19\i_fab04	Session Start	and start screen recording when a is detected	
4	XF4B5\Administrator	9/18/2023 8:52:36 A		C:\SessionRecordings\2023\09\18\i_3c71c	Session Start	Email alert when a s	Session Start
5	XF4B5\Administrator	9/18/2023 8:53:09 A	perf	C:\SessionRecordings\2023\09\18\i_3c71c	Session Start	and disconnect session when a is detected	
6	XF4B5\Administrator	9/16/2023 3:03:56 A		C:\SessionRecordings\2023\09\16\i_98cdc	Session Start	Email alert when a s	Session Start
7	XF4B5\Administrator	9/18/2023 3:09:06 A		C:\SessionRecordings\2023\09\18\i_98cdc	Session Start	Email alert when a s	Session Start
8	XF4B5\Administrator	9/18/2023 6:58:15 A	web search	C:\SessionRecordings\2023\09\18\i_98cdc	WebBrowsing	Email alert and lock	WebBrowsing<SPLT
9	XF4B5\Administrator	9/20/2023 5:41:04 A	perf	C:\SessionRecordings\2023\09\19\i_98cdc	Session Start	and start screen recording when a is detected	
10	XF4B5\Administrator	9/20/2023 5:50:37 A	perf	C:\SessionRecordings\2023\09\19\i_98cdc	Session Start	and start screen recording when a is detected	
11	XF4B5\Administrator	9/20/2023 5:51:07 A	perf	C:\SessionRecordings\2023\09\19\i_98cdc	Session Start	and start screen recording when a is detected	
12	XF4B5\Administrator	9/20/2023 6:14:43 A	perf	C:\SessionRecordings\2023\09\19\i_98cdc	Session Start	and start screen recording when a is detected	
13	XF4B5\Administrator	9/20/2023 6:26:47 A	perf	C:\SessionRecordings\2023\09\19\i_98cdc	Session Start	and start screen recording when a is detected	
14	XF4B5\Administrator	9/20/2023 6:56:26 A	perf	C:\SessionRecordings\2023\09\19\i_98cdc	Session Start	and start screen recording when a is detected	
15	XF4B5\Administrator	9/20/2023 3:28:23 A	perf	C:\SessionRecordings\2023\09\19\i_98cdc	Session Start	and start screen recording when a is detected	
16	XF4B5\Administrator	9/20/2023 3:29:24 A	perf	C:\SessionRecordings\2023\09\19\i_98cdc	Session Start	and start screen recording when a is detected	
17	XF4B5\Administrator	9/20/2023 3:29:54 A	perf	C:\SessionRecordings\2023\09\19\i_98cdc	Session Start	and start screen recording when a is detected	
18	XF4B5\Administrator	9/20/2023 3:30:24 A	perf	C:\SessionRecordings\2023\09\19\i_98cdc	Session Start	and start screen recording when a is detected	
19	XF4B5\Administrator	9/20/2023 3:31:25 A	perf	C:\SessionRecordings\2023\09\19\i_98cdc	Session Start	and start screen recording when a is detected	
20	XF4B5\Administrator	9/20/2023 3:31:54 A	perf	C:\SessionRecordings\2023\09\19\i_98cdc	Session Start	and start screen recording when a is detected	
21	XF4B5\Administrator	9/20/2023 6:44:52 A	perf	C:\SessionRecordings\2023\09\19\i_98cdc	Session Start	and start screen recording when a is detected	
22	XF4B5\Administrator	9/20/2023 6:46:52 A	perf	C:\SessionRecordings\2023\09\19\i_98cdc	Session Start	and start screen recording when a is detected	
23	XF4B5\Administrator	9/20/2023 3:32:24 A	perf	C:\SessionRecordings\2023\09\19\i_98cdc	Session Start	and start screen recording when a is detected	
24	XF4B5\Administrator	9/20/2023 3:32:54 A	perf	C:\SessionRecordings\2023\09\19\i_98cdc	Session Start	and start screen recording when a is detected	
25	XF4B5\Administrator	9/20/2023 3:33:24 A	perf	C:\SessionRecordings\2023\09\19\i_98cdc	Session Start	and start screen recording when a is detected	
26	XF4B5\Administrator	9/20/2023 6:19:45 A	perf	C:\SessionRecordings\2023\09\19\i_98cdc	Session Start	and start screen recording when a is detected	
27	XF4B5\Administrator	9/20/2023 6:20:15 A	perf	C:\SessionRecordings\2023\09\19\i_98cdc	Session Start	and start screen recording when a is detected	
28	XF4B5\Administrator	9/20/2023 6:26:17 A	perf	C:\SessionRecordings\2023\09\19\i_98cdc	Session Start	and start screen recording when a is detected	
29	XF4B5\Administrator	9/20/2023 6:27:18 A	perf	C:\SessionRecordings\2023\09\19\i_98cdc	Session Start	and start screen recording when a is detected	
30	XF4B5\Administrator	9/20/2023 6:27:47 A	perf	C:\SessionRecordings\2023\09\19\i_98cdc	Session Start	and start screen recording when a is detected	
31	XF4B5\Administrator	9/20/2023 6:52:54 A	perf	C:\SessionRecordings\2023\09\19\i_98cdc	Session Start	and start screen recording when a is detected	
32	XF4B5\Administrator	9/20/2023 5:41:33 A	perf	C:\SessionRecordings\2023\09\19\i_98cdc	Session Start	and start screen recording when a is detected	

Configuration

To receive emailed event response reports on a daily or weekly basis, schedule reports through Session Recording Server Properties. Make sure to configure outgoing email settings on the **Email** tab too.

Note:

If your Session Recording servers are configured in a load balancing manner, schedule reports on one of the servers. Otherwise, create a schedule on each of your Session Recording servers.

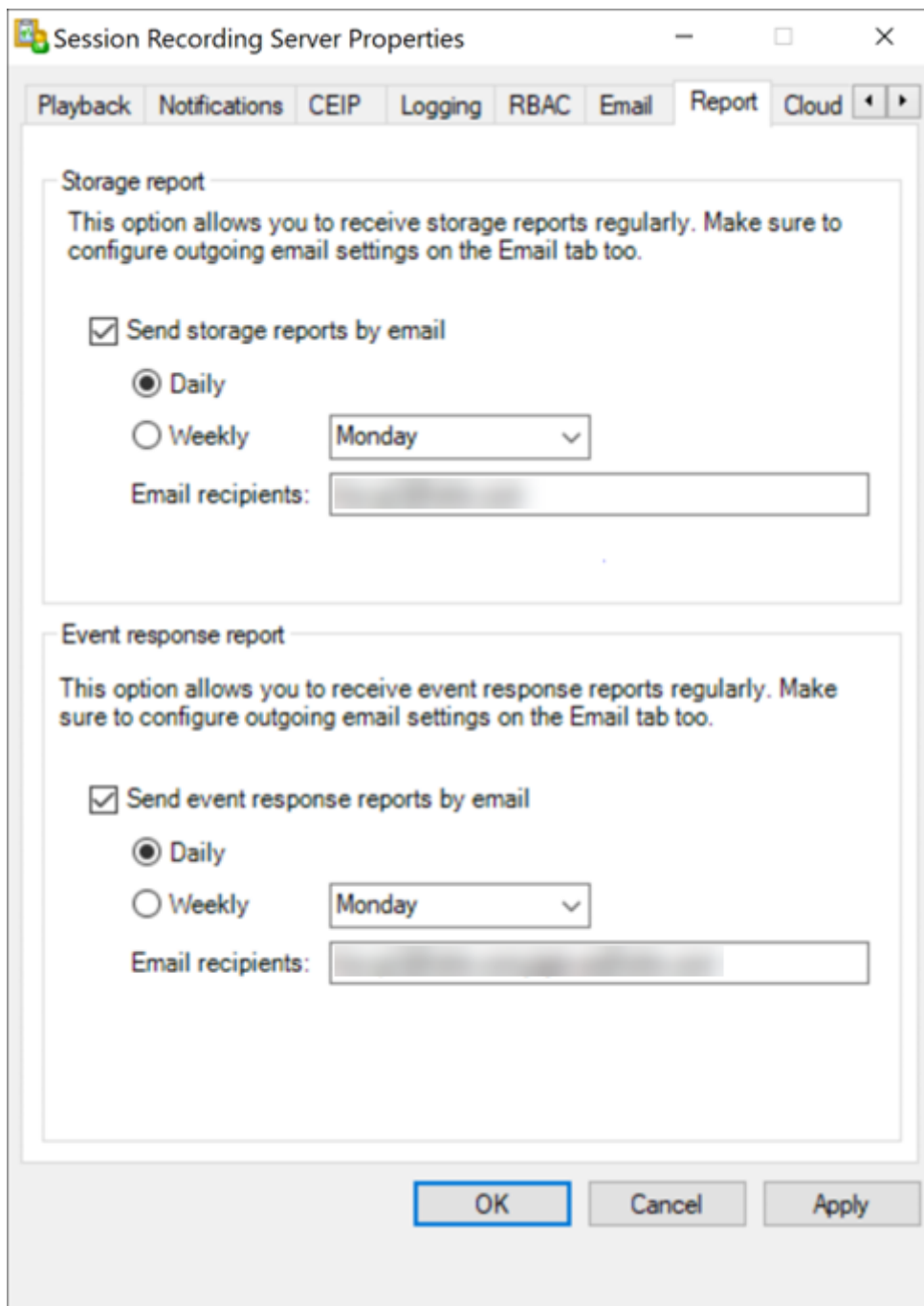

Session recording storage reports

December 3, 2024

Overview

A session recording storage report provides weekly statistics on screen recordings of a single or multiple load-balanced Session Recording servers. It is emailed to you and contains digest charts similar to the following:

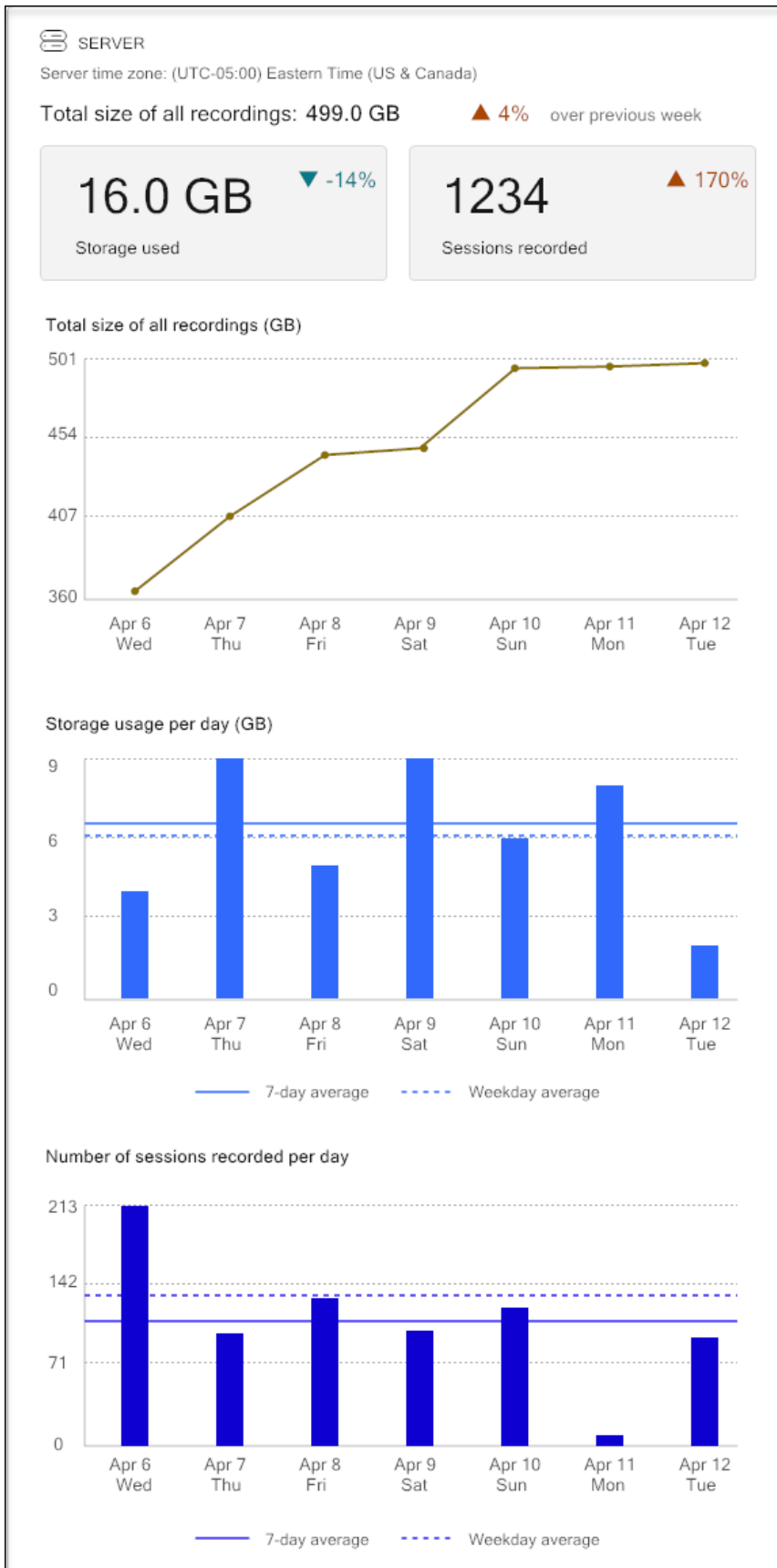

Configuration

To receive emailed session recording storage reports on a daily or weekly basis, schedule reports through Session Recording Server Properties. Make sure to configure outgoing email settings on the **Email** tab too.

Note:

If your Session Recording servers are configured in a load balancing manner, schedule reports on one of the servers. Otherwise, create a schedule on each of your Session Recording servers.

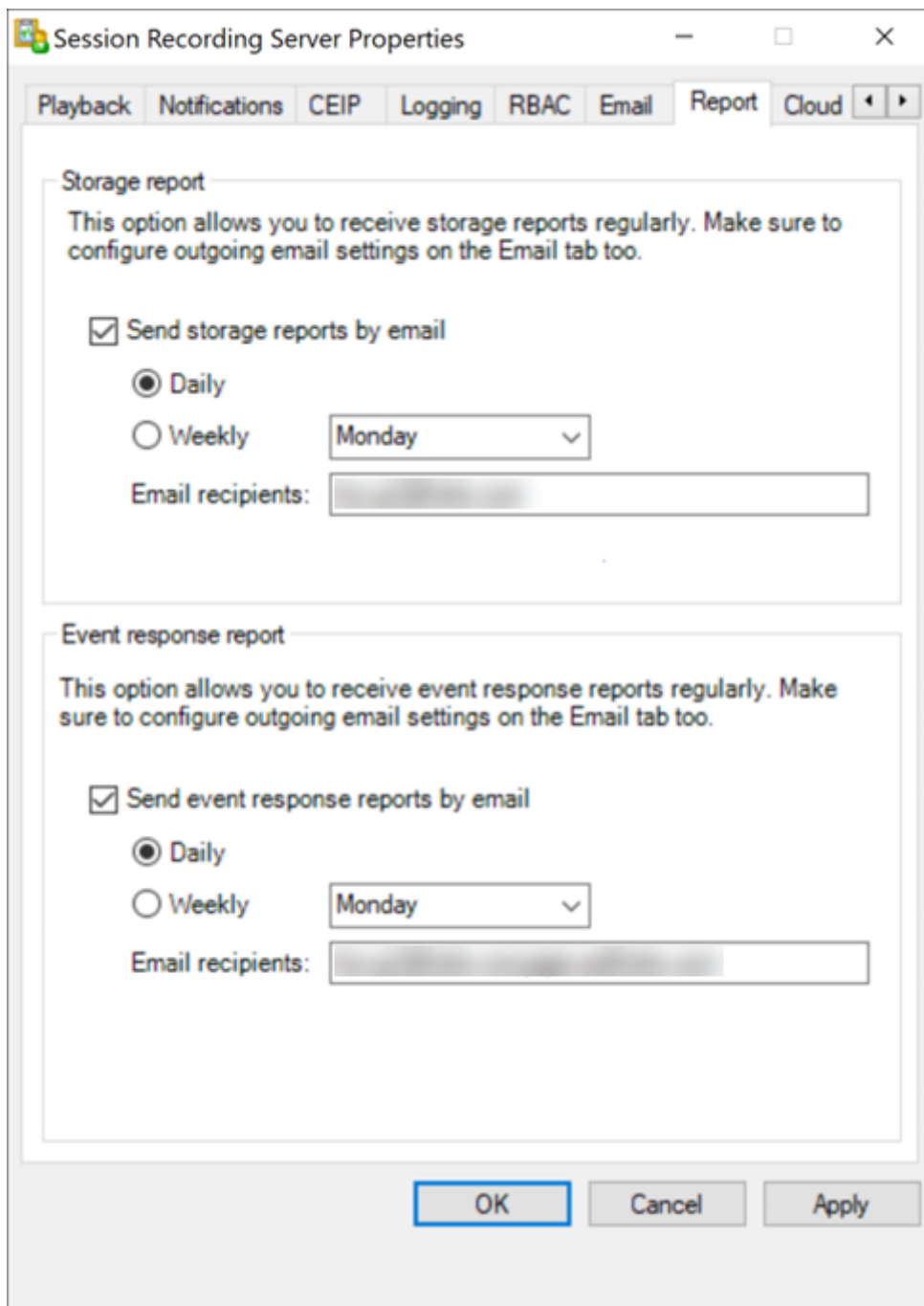

Specify file size for recordings

December 3, 2024

As recordings grow in size, recording files take longer to download and respond more slowly when you use the seek slider to navigate during playback. To control file size, specify a threshold limit for a

file. When the recording reaches this limit, Session Recording closes the file and creates an extra file to continue recording. This action is called a rollover.

You can specify two thresholds for a rollover:

- **File size.** The current file closes when it reaches the size, and a new file opens. By default, the rollover occurs when the size exceeds 50 MB. Supported values: 10-300.
- **Duration.** When the duration is reached, the current file closes and a new file opens. By default, the rollover occurs when the session records for 12 hours. Supported values: 1-24.

Rollovers occur when the first of the two conditions above is met. For example, you specify 17 MB for the size and 6 hours for the duration. When your recording reaches 17 MB in 3 hours, Session Recording closes the file and opens a new one.

To prevent the creation of many small files, Session Recording doesn't roll over until at least one hour elapses regardless of the value specified for the file size. The exception to this rule is if the file size surpasses 300 MB.

Specify the maximum file size for recordings

1. Log on to the machine hosting the Session Recording server.
2. From the **Start** menu, choose **Session Recording Server Properties**.
3. In **Session Recording Server Properties**, click the **Rollover** tab.

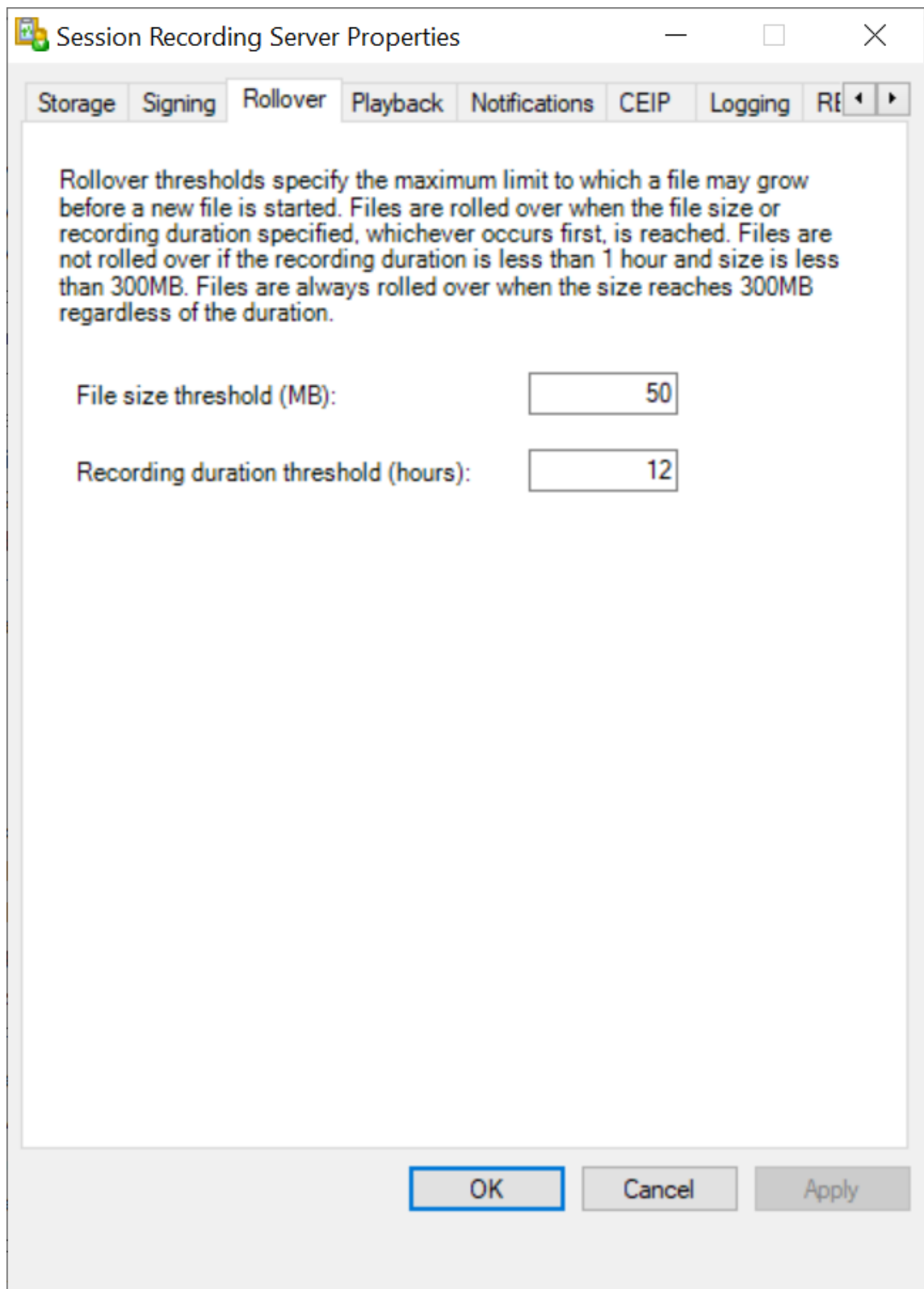

The screenshot shows a Windows-style dialog box titled "Session Recording Server Properties". The "Rollover" tab is selected, and the following text is displayed:

Rollover thresholds specify the maximum limit to which a file may grow before a new file is started. Files are rolled over when the file size or recording duration specified, whichever occurs first, is reached. Files are not rolled over if the recording duration is less than 1 hour and size is less than 300MB. Files are always rolled over when the size reaches 300MB regardless of the duration.

Below the text are two input fields:

- File size threshold (MB):
- Recording duration threshold (hours):

At the bottom of the dialog are three buttons: "OK", "Cancel", and "Apply".

4. Type an integer between 10 and 300 to specify the maximum file size in MB.
5. Type an integer between 1 and 24 to specify the maximum recording duration in hours.

Specify recording storage locations

December 11, 2024

You can store recordings on a local drive, a SAN volume, and a location specified by a UNC network path. You can also store recordings in Azure file shares and Amazon Simple Storage Service (Amazon S3).

Note:

- Storing data on a NAS, based on file-based protocols such as SMB and NFS, might have performance and security implications. Use the latest version of the protocol to avoid security implications and perform scale testing to ensure proper performance.
- To archive files or restore deleted files, use the [ICLDB](#) command.

This article walks you through the following procedures:

- Specify recording storage locations in Session Recording Server Properties
- Store recordings in an Azure file share
- Store recordings in Amazon S3
- Store recordings in a network shared folder

Specify recording storage locations in Session Recording Server Properties

This section provides a general procedure for setting storage locations in Session Recording Server Properties.

1. Log on to the machine hosting the Session Recording server.
2. From the **Start** menu, choose **Session Recording Server Properties**.
3. In **Session Recording Server Properties**, click the **Storage** tab.
4. Use the **File storage directories** list to manage the folders where recordings are stored.

After you select the folders, Session Recording grants its service with Full Control permission to these folders.

By default, recordings are stored in the **<drive>:\SessionRecordings** folder of the machine hosting the Session Recording server. You can change the folder where you store recordings, add extra folders to load-balance across multiple volumes, or make use of more space. Multiple folders in the list indicate that recordings are load-balanced across the folders. Load balancing cycles through the folders.

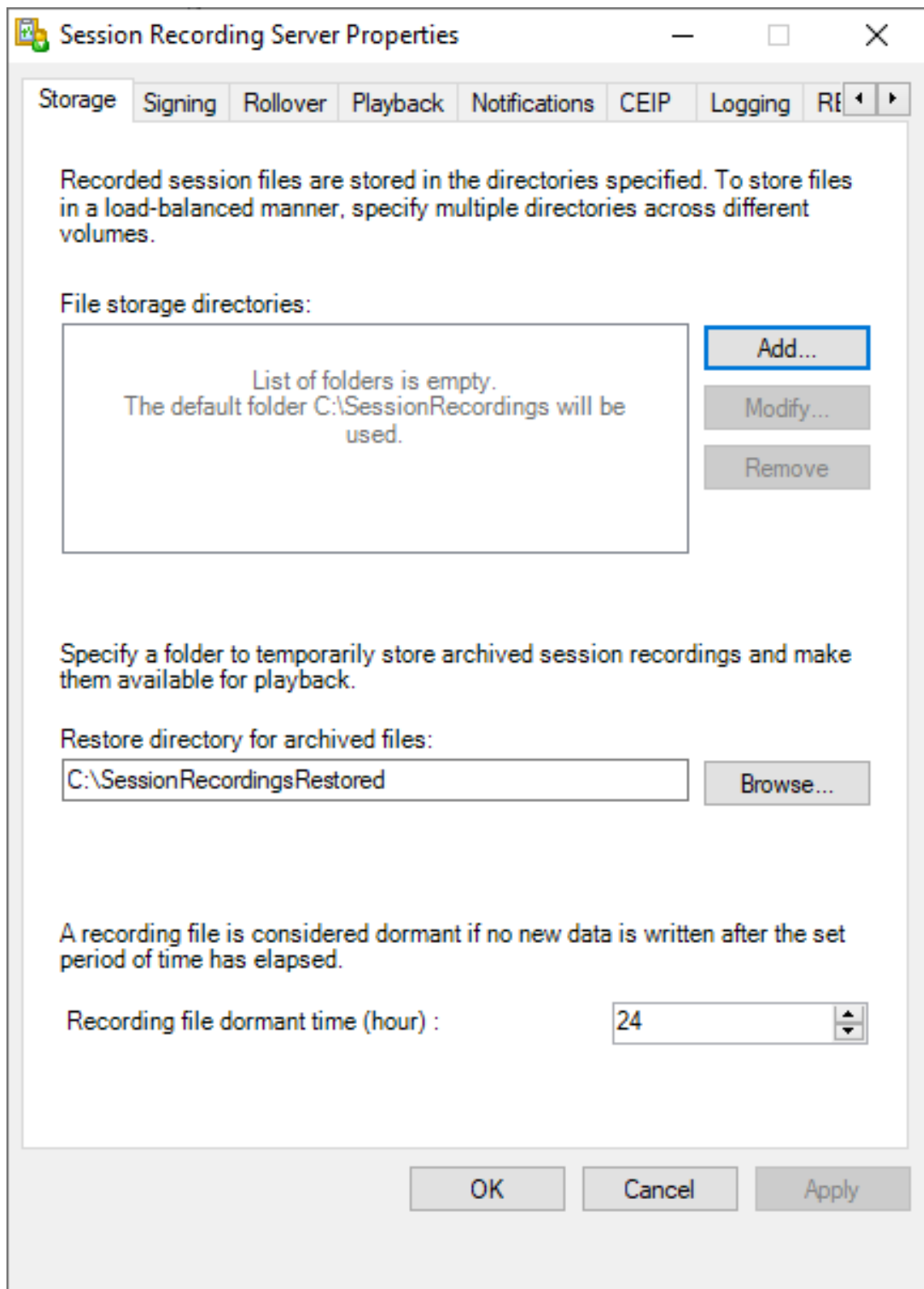

5. In the **Restore directory for archived files** field, specify a folder for restoring archived recordings. You can specify only one folder for restoring archived recordings.

By default, archived recordings are restored in the **<drive>:\SessionRecordingsRestore** folder of the machine hosting the Session Recording server. You can change the folder.

Store recordings in an Azure file share

To store recordings in an Azure file share, complete the following steps:

1. In the [Azure portal](#), create a storage account and then create an Azure file share.

For a quick start guide, see [Create and manage Azure file shares with the Azure portal](#). The following table recommends configurations for your consideration.

Recording File Size MB/hour	Session Quantity	File Share Type	File Share Quota (TB)	Session Recording Server Quantity	Session Recording Server Size
< 6.37	< 1,000	HDD Standard (StorageV2)	2	1	Standard D4as_v4
< 6.37	1,000–2,000	SSD Premium	3	1	Standard D4as_v4
< 6.37	2,000–3,000	SSD Premium	5	1	Standard D4as_v4
< 6.37	3,000–4,000	SSD Premium	6	1	Standard D4as_v4
Approx.10	< 1,000	HDD Standard (StorageV2)	3	1	Standard D4as_v4
Approx.10	1,000–2,500	SSD Premium	6	1	Standard D4as_v4
Approx.10	2,500–4,000	SSD Premium	10	2	Standard D4as_v4

The file share quota is calculated based on eight hours per day, 23 working days per month, and a one-month retention period for each recording file.

2. Add the Azure file share credentials to the host where you installed the Session Recording server.
 - a) Start a command prompt as an administrator and change the drive to the **<Session Recording Server installation path>\Bin** folder.

By default, the Session Recording server is installed in `C:\Program Files\Citrix\SessionRecording\Server`.

- b) Run the **SsRecUtils.exe -AddAzureFiles <storageAccountName> <fileShareName> <accesskey>** command.

Where,

- **<storageaccountname>** is the name of your storage account in Azure.
- **<filesharename>** is the name of the file share contained within your storage account.
- **<accesskey>** is your storage account key that can be used to access the file share.

There are two ways to obtain your storage account key:

- You can obtain your storage account key from the connection string that appears when you click the **Connect** icon in your file share page.

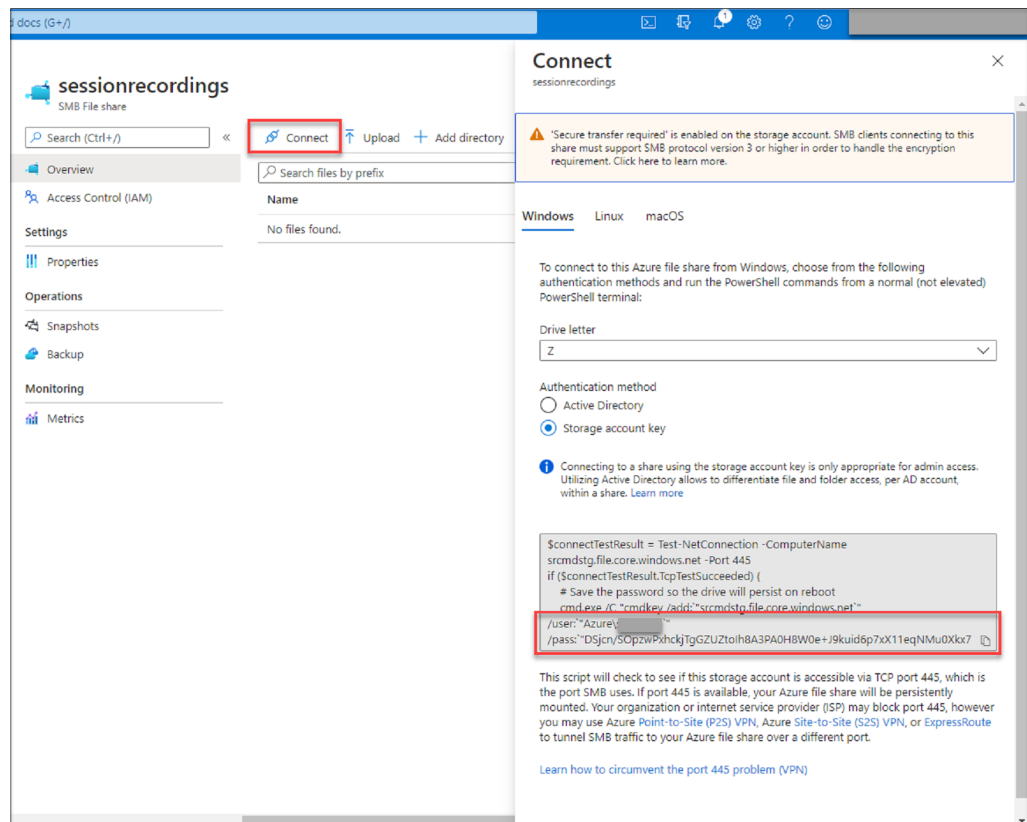

- You can also obtain your storage account key by clicking **Access keys** in the left navigation of your storage account page.

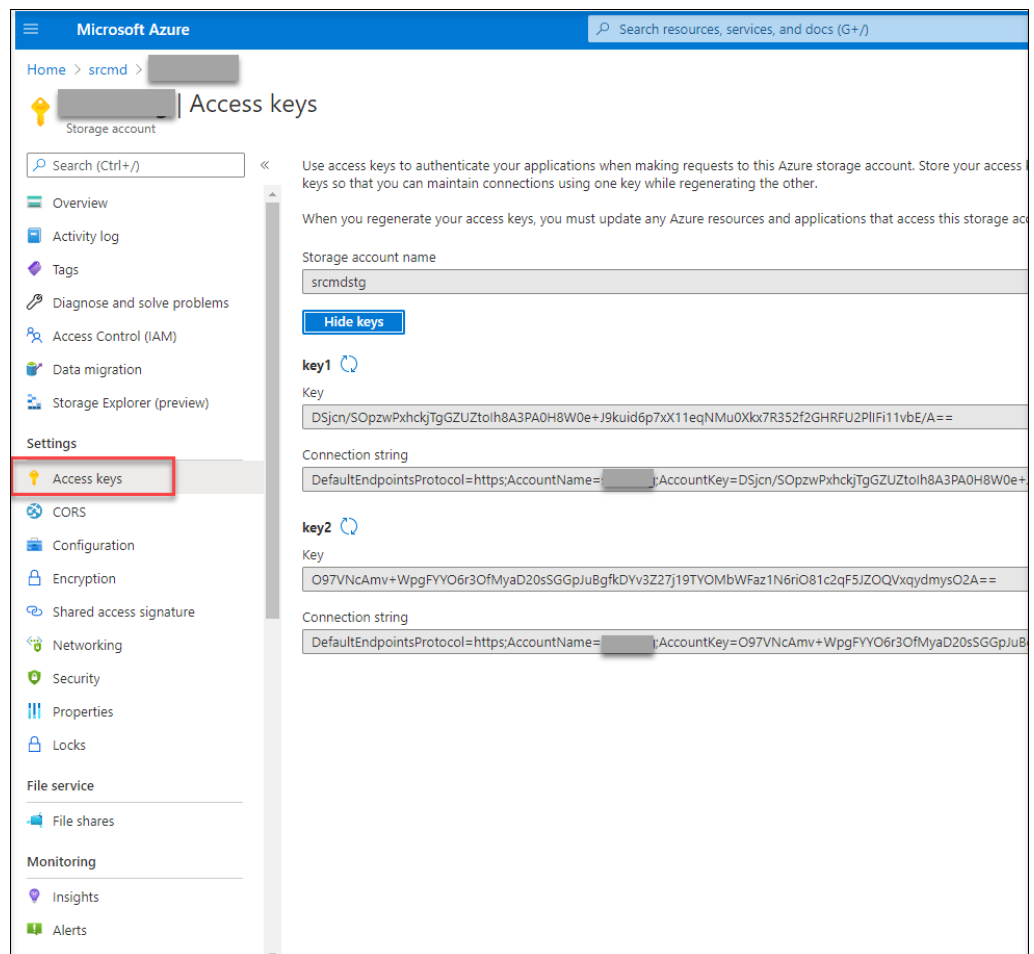

- c) Mount the Azure file share to the host where you installed the Session Recording server.
- i. Open **Session Recording Server Properties**.
 - ii. Click **Add** on the **Storage** tab.
 - iii. Enter the UNC path in the format of `\\<storageaccountname>.file.core.windows.net\<fileshare>`
- Specify a subfolder under the file share to store your recording files. The Session Recording server then automatically creates the subfolder for you.

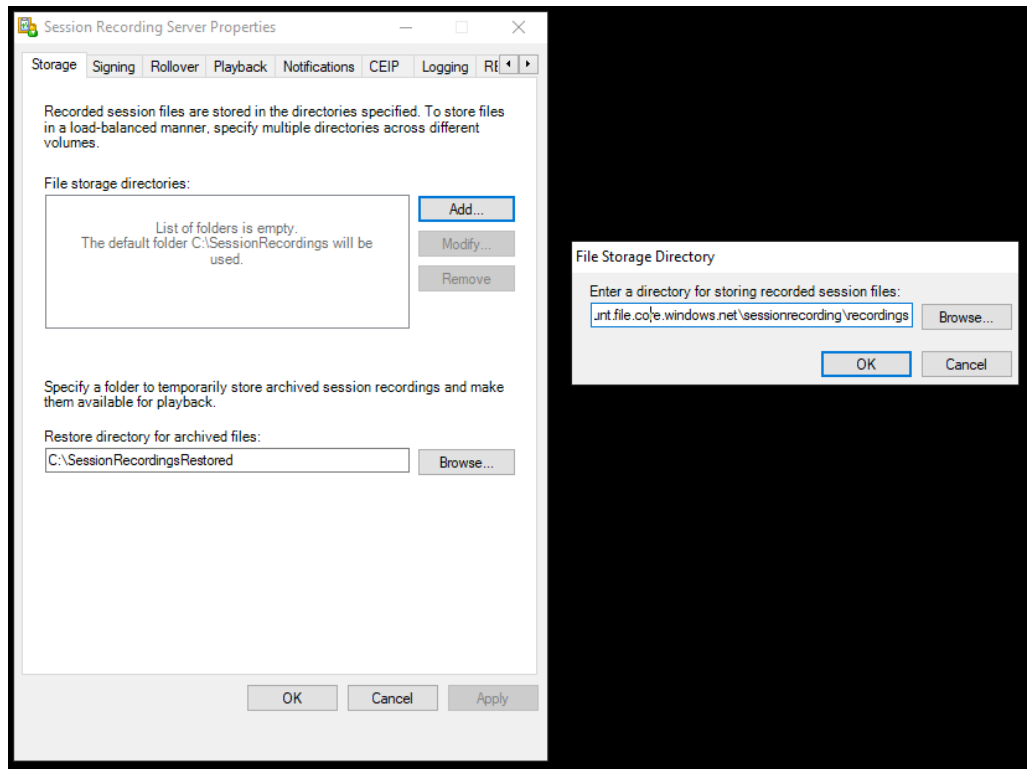

- iv. Click **OK** in the **File Storage Directory** dialog box.
- v. Click **Apply** in the **Session Recording Server Properties** window.
- vi. Click **OK** after **Apply** becomes grayed out.
- vii. Click **Yes** when you're prompted to restart the Session Recording Storage Manager service.

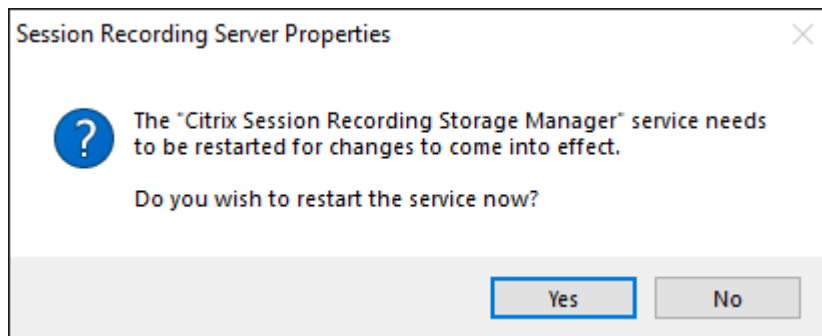

Store recordings in Amazon S3

Recommendations

1. Install the Session Recording server on t2.xlarge or other AWS EC2 instances with higher specifications.

2. Set the storage limit on Message Queues to a minimum of 4,194,304 KB (4 GB).

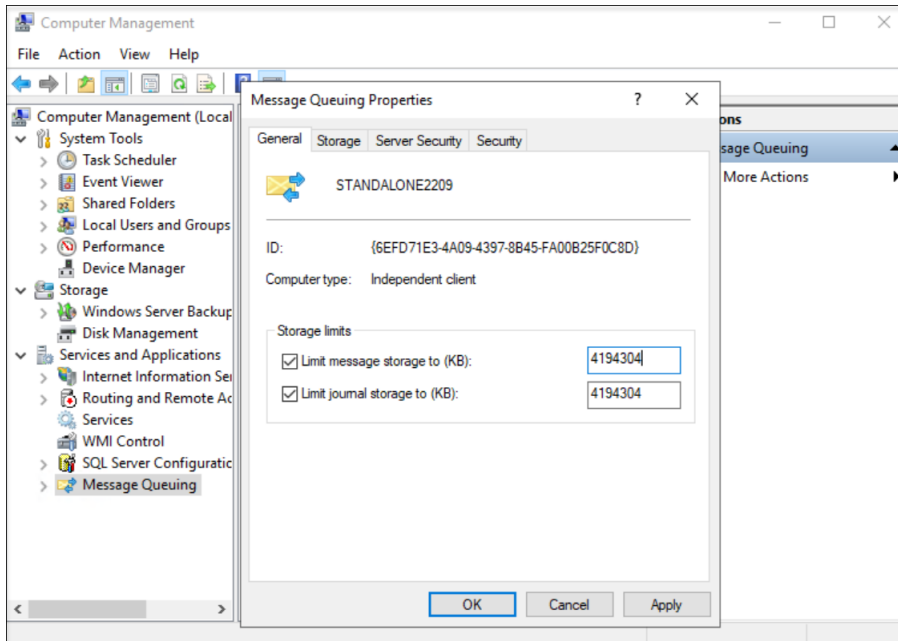

3. In Session Recording Agent Properties, set the lifetime of the messages on Message Queues to 14,400 seconds (4 hours).

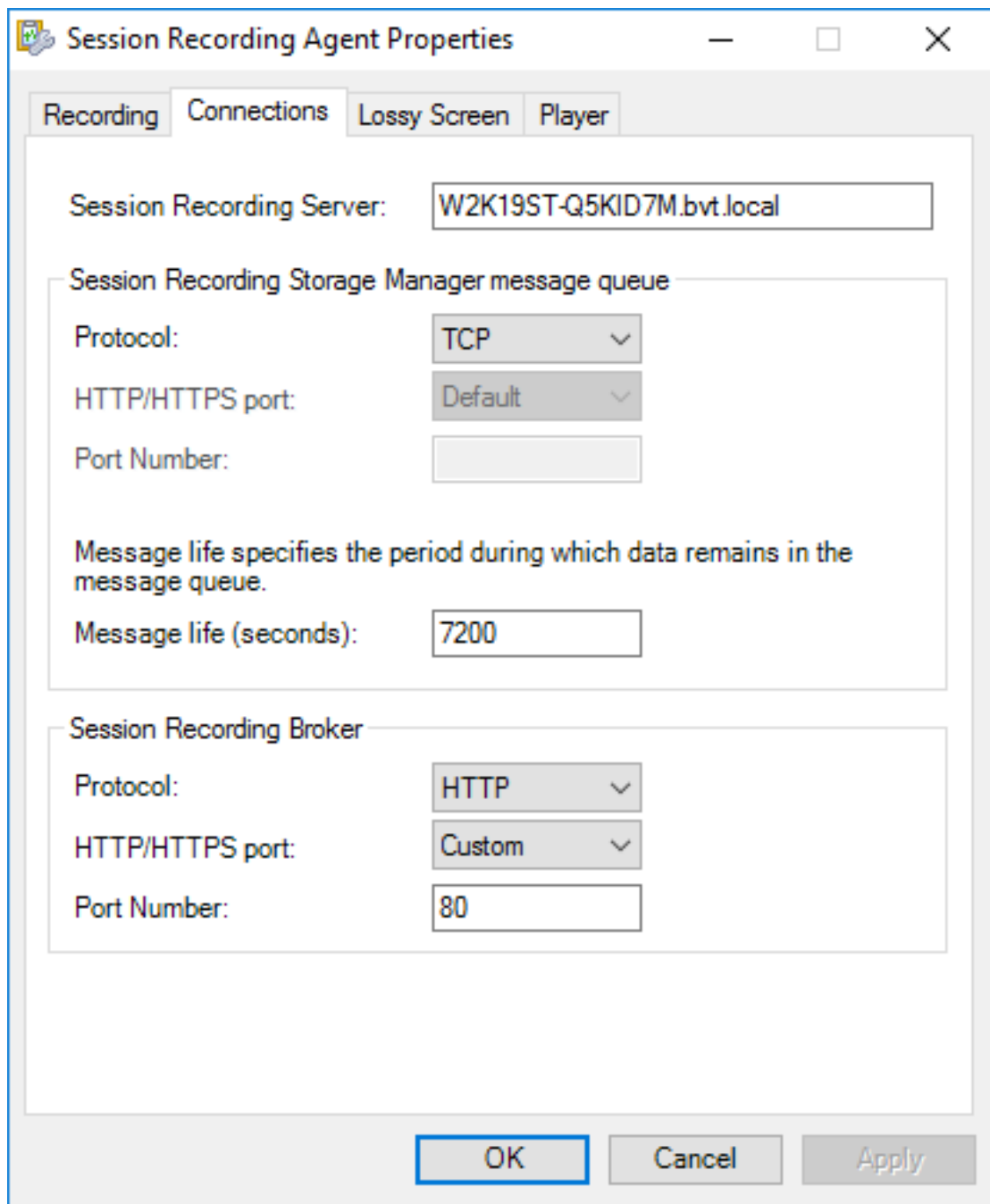

The screenshot shows the 'Session Recording Agent Properties' dialog box with the 'Connections' tab selected. The 'Recording' tab is also visible. The 'Session Recording Server' field contains 'W2K19ST-Q5KID7M.bvt.local'. The 'Session Recording Storage Manager message queue' section includes a 'Protocol' dropdown set to 'TCP', an 'HTTP/HTTPS port' dropdown set to 'Default', and an empty 'Port Number' field. Below this is a text box explaining 'Message life specifies the period during which data remains in the message queue.' and a 'Message life (seconds)' field set to '7200'. The 'Session Recording Broker' section includes a 'Protocol' dropdown set to 'HTTP', an 'HTTP/HTTPS port' dropdown set to 'Custom', and a 'Port Number' field set to '80'. At the bottom are 'OK', 'Cancel', and 'Apply' buttons.

Field	Value
Session Recording Server	W2K19ST-Q5KID7M.bvt.local
Protocol (Storage Manager)	TCP
HTTP/HTTPS port (Storage Manager)	Default
Port Number (Storage Manager)	
Message life (seconds)	7200
Protocol (Broker)	HTTP
HTTP/HTTPS port (Broker)	Custom
Port Number (Broker)	80

Note:

During the update or maintenance of the AWS Storage Gateway, recording files might not be saved from the Session Recording server to the file share. Data losses can occur.

Steps

To store recordings in Amazon S3, complete the following steps:

1. Create an Amazon S3 bucket. For more information, see the Amazon documentation [Creating a bucket](#).

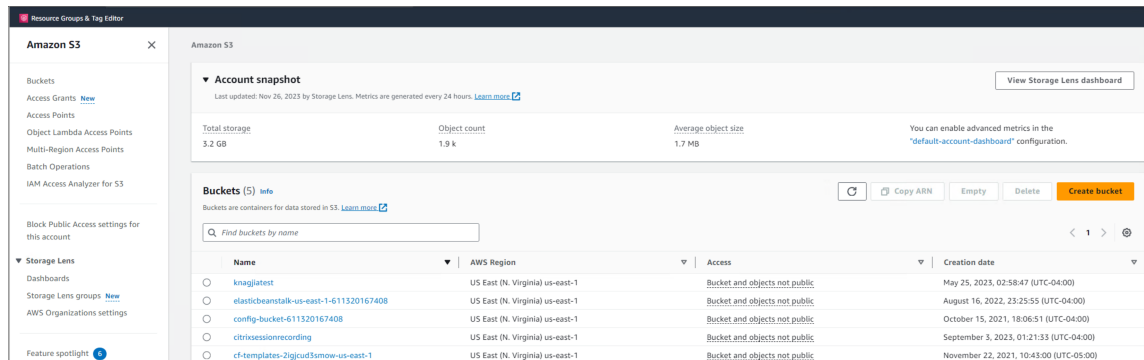

2. Create and activate an Amazon S3 File Gateway. Doing so enables data transfer to and from the Amazon S3 bucket created earlier.

For step-by-step instructions, see the following Amazon documentation:

- [Create and activate an Amazon S3 File Gateway](#)
- [Getting an activation key for your gateway](#)

3. Create a file share with guest access. When creating the file share, select the Amazon S3 File Gateway that you created earlier and connect the file share to your Amazon S3 bucket. For more information, see the Amazon documentation [Create a file share](#).
4. Go to the machine where you installed the Session Recording server and complete the following steps:

- a) Add the file share credentials to the Session Recording server. To do so, start a command prompt as an administrator and change the drive to the **<Session Recording Server installation path>\Bin** folder. By default, the Session Recording server is installed in C:\Program Files\Citrix\SessionRecording\Server. Then run the **SsRecUtils.exe -AddAwsS3 <GatewayIPAddress> <S3Path> <GatewayID> <Password>** command.

Where,

- **<GatewayIPAddress>** is the IP address of your Amazon S3 File Gateway.
- **<S3Path>** is the name of your Amazon S3 bucket.
- **<GatewayID>** is the ID of your Amazon S3 File Gateway.
- **<Password>** is the guest password that you set when creating the file share.

All the information except for the guest password is available on the file share page similar to the following. As for the guest password, you must keep a careful record yourself.

Example Commands

You can use the following example commands to connect to the file share.

On Microsoft Windows: `net use [WindowsDriveLetter]: \\[GatewayIPAddress]\citrixsessionrecording /user:sgw-56599C3F\smbguest`

- b) Set the file share as the location for storing your recordings.
- i. Open **Session Recording Server Properties**.
 - ii. Click **Add** on the **Storage** tab.
 - iii. Enter the UNC path in the format of `\<GatewayIPAddress>\<S3Path>\<subfolder>`. Specify a subfolder under the file share to store your recording files. The Session Recording server then automatically creates the subfolder for you.

Store recordings in a network shared folder**Note:**

- For an accessible network shared folder, the Session Recording server accesses it through SMB by default.
- Storing data on a NAS, based on file-based protocols such as SMB and NFS, might have performance and security implications. Use the latest version of the protocol to avoid security implications and perform scale testing to ensure proper performance.

Steps

To store recordings in a network shared folder, complete the following steps:

1. Create an account with read and write permissions for the network shared folder to be created later. To do so, use the Windows GUI or run a PowerShell command similar to the following:

```
1 New-LocalUser -Name "YourUserName" -Password (ConvertTo-SecureString -String "YourPassword" -AsPlainText -Force)
```

2. Create a network shared folder and ensure that the shared folder is accessible to the Session Recording Server. To do so, use the Windows GUI or run the PowerShell commands similar to the following:

```
1 New-SmbShare -Name "YourShareName" -Path "YourSharePath" -
  FullAccess "YourUserName"
2
3 Grant-SmbShareAccess -Name "YourShareName" -AccessRight Change -
  AccountName "YourUserName"
```

3. Go to the machine where you installed the Session Recording server and complete the following steps:

- a) Add the credentials for the created account to the Session Recording server. To do so, start a command prompt as an administrator and change the drive to the **<Session Recording Server installation path>\Bin** folder. By default, the Session Recording server is installed in C:\Program Files\Citrix\SessionRecording\Server. Then run the **SsRecUtils.exe -AddSharedFolder <IPAddress> <ShareName> <Protocol> <Username> <Password>** command.

Where,

- **<IPAddress>** is the IP address of the machine where the shared folder resides.
- **<ShareName>** is the share name.
- **<Protocol>** is fixed to SMB.
- **<Username>** is the user name that you set for the shared folder.
- **<Password>** is the password that you set for the shared folder.

For example, if **\\10.100.100.100\myshare** is your shared folder, you can run a command similar to **SsRecUtils -AddSharedFolder 10.100.100.100 myshare SMB myusername mypassword**.

- b) Set the shared folder as the location for storing your recordings.
 - i. Open **Session Recording Server Properties**.
 - ii. Click **Add** on the **Storage** tab.
 - iii. Enter the UNC path in the format of **\<IPAddress><ShareName>\<subfolder>**. Specify a subfolder under the shared folder to store your recording files. The Session Recording server then automatically creates the subfolder for you.

Policies

December 3, 2024

Use the Session Recording Policy Console to create recording policies, event detection policies, event response policies, and recording viewing policies. When creating the policies, you can specify Delivery Controllers from both the Citrix Cloud and on-premises environments.

Important:

To use the Session Recording Policy Console, you must have the Broker PowerShell Snap-in (Broker_PowerShellSnapIn_x64.msi) or the Citrix DaaS Remote PowerShell SDK (CitrixPoshSdk.exe) installed manually. Locate the Broker PowerShell snap-in on the Citrix Virtual Apps and Desktops

ISO (\x64\Citrix Desktop Delivery Controller). Or, download the [Citrix DaaS Remote PowerShell SDK](#) from the [Citrix DaaS \(formerly Citrix Virtual Apps and Desktops service\) download page](#).

Tip:

You can edit the registry to prevent recording file losses in case that your Session Recording server might fail unexpectedly. Log on as an administrator to the machine where you installed the Session Recording Agent, open the Registry Editor, and add a DWORD value `DefaultRecordActionOnError =1` under `HKEY_LOCAL_MACHINE\SOFTWARE\Citrix\SmartAuditor\Agent`.

Activate a policy

1. Log on as an administrator to the machine where you installed the Session Recording Policy Console.
2. Start the Session Recording Policy Console.
3. If the **Connect to Session Recording Server** window appears, ensure that the name of the Session Recording server, protocol, and port are correct. Click **OK**.
4. In the Session Recording Policy Console, expand the target policy type.
5. Select the policy to activate.
6. From the menu bar, choose **Activate Policy**.

Modify a policy

1. Log on as an administrator to the machine where you installed the Session Recording Policy Console.
2. Start the Session Recording Policy Console.
3. If the **Connect to Session Recording Server** window appears, ensure that the name of the Session Recording server, protocol, and port are correct. Click **OK**.
4. In the Session Recording Policy Console, expand the target policy type.
5. Select the policy that you want to modify. The rules for the policy appear in the right pane.
6. To add, modify, or delete a rule:
 - From the menu bar, choose **Add New Rule**. If the policy is active, a pop-up window appears requesting confirmation of the action. Use the **Rules** wizard to create a rule.
 - Select the rule that you want to modify, right-click, and choose **Properties**. Use the **Rules** wizard to modify the rule.
 - Select the rule that you want to delete, right-click, and choose **Delete Rule**.

Delete a policy

Note:

You cannot delete a system-defined policy or a policy that is active.

1. Log on as an administrator to the machine where you installed the Session Recording Policy Console.
2. Start the Session Recording Policy Console.
3. If the **Connect to Session Recording Server** window appears, ensure that the name of the Session Recording server, protocol, and port are correct. Click **OK**.
4. In the Session Recording Policy Console, expand the target policy type.
5. In the left pane, select the policy to delete. If the policy is active, you must activate another policy.
6. From the menu bar, choose **Delete Policy**.
7. Select **Yes** to confirm the action.

Configure session recording policies

December 3, 2024

You can activate system-defined recording policies or create and activate your own custom recording policies. System-defined recording policies apply a single rule to entire sessions. Custom recording policies specify which sessions are recorded.

The active recording policy determines which sessions are recorded. Only one recording policy is active at a time.

System-defined recording policies

Session Recording provides the following system-defined recording policies:

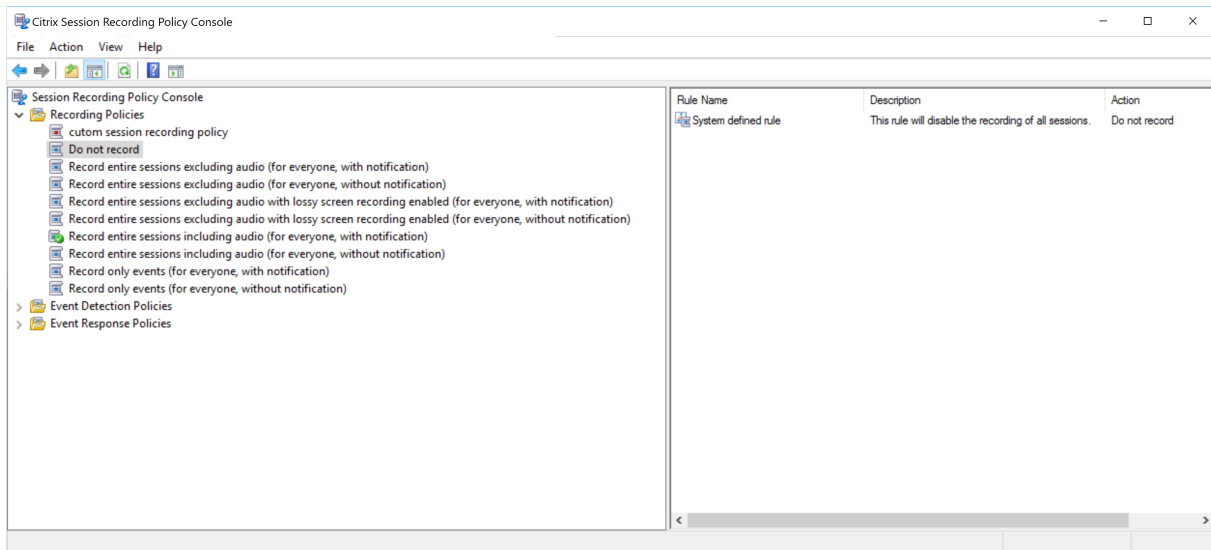

- **Do not record.** The default policy. If you do not specify another policy, no sessions are recorded.
- **Record entire sessions excluding audio (for everyone, with notification).** This policy records entire sessions (including screens and events but excluding audio). Users receive recording notifications in advance.
- **Record entire sessions excluding audio (for everyone, without notification).** This policy records entire sessions (including screens and events but excluding audio). Users do not receive recording notifications.
- **Record entire sessions excluding audio with lossy screen recording enabled (for everyone, with notification).** This policy records entire sessions (including screens and events but excluding audio). Lossy screen recording is enabled to reduce the size of recording files. Users receive recording notifications in advance.
- **Record entire sessions excluding audio with lossy screen recording enabled (for everyone, without notification).** This policy records entire sessions (including screens and events but excluding audio). Lossy screen recording is enabled to reduce the size of recording files. Users do not receive recording notifications.
- **Record entire sessions including audio (for everyone, with notification).** This policy records entire sessions (including screens, events, and audio). Users receive recording notifications in advance. You can now enable audio recording for non-optimized HDX audio. The audio that is handled on the VDA and delivered to/from the client where the Citrix Workspace app is installed is referred to as non-optimized HDX audio. Unlike non-optimized HDX audio, optimized HDX audio has its processing offloaded to the client, as seen in the Browser Content Redirection (BCR) and Optimization for Microsoft Teams scenarios.

- **Record entire sessions including audio (for everyone, without notification).** This policy records entire sessions (including screens, events, and audio). Users do not receive recording notifications.
- **Record only events (for everyone, with notification).** This policy records only events that your event detection policy specifies. It does not record screens or audio. Users receive recording notifications in advance.
- **Record only events (for everyone, without notification).** This policy records only events that your event detection policy specifies. It does not record screens or audio. Users do not receive recording notifications.

You can't modify or delete the system-defined recording policies.

Create a custom recording policy

Considerations

You can record sessions of specific users or groups, published applications or desktops, delivery groups or VDA machines, and Citrix Workspace app client IP addresses. To obtain the lists of published applications or desktops and delivery groups or VDA machines, you must have the **read** permission as a site administrator. Configure the administrator **read** permission on the Delivery Controller of the site.

You can also specify smart access tags to use as scopes for a custom recording policy to apply to. **This feature is available for Session Recording 2402 and later.** It lets you apply policies based on the user access context including:

- The user's location
- IP address range
- Delivery group
- Device type
- Installed applications

A wizard within the Session Recording policy console helps you create rules. For each rule you create, you specify a recording action and rule criteria. The recording action applies to sessions that meet the rule criteria.

For each rule, choose one recording action:

The screenshot shows the 'Rules Wizard' dialog box with the following content:

Step 1: Select a recording option to specify if and how a session is recorded.

- Enable session recording with notification
 - Enable audio recording
 - Enable lossy screen recording
- Enable session recording without notification
 - Enable audio recording
 - Enable lossy screen recording
- Enable event only session recording with notification
- Enable event only session recording without notification
- Disable session recording

Step 1-2: Set parameters for screen recording

Hide specific applications during screen recording.

Type the process names of the applications that you want to hide. Separate the process names with a semicolon (;) Black ▾

< Back Next > Cancel

- **Enable session recording with notification.** This option records entire sessions (screens and events). Users receive recording notifications in advance. With this option selected, you can further select to enable audio recording or lossy screen recording. Additionally, you can choose to hide specific applications in screen recordings.
- **Enable session recording without notification.** This option records entire sessions (screens and events). Users do not receive recording notifications. With this option selected, you can further select to enable audio recording or lossy screen recording. Additionally, you can choose to hide specific applications in screen recordings.
- **Enable event only session recording with notification.** Recording only specific events helps to free up storage space. This option records throughout sessions only events that your event detection policy specifies. It does not record screens. Users receive recording notifications in advance.
- **Enable event only session recording without notification.** Recording only specific events helps to free up storage space. This option records throughout sessions only events that your

event detection policy specifies. It does not record screens. Users do not receive recording notifications.

- **Disable session recording.** This option means that no sessions are recorded.
- **Hide specific applications during screen recording.** This feature lets you hide specific applications with a layer mask during screen recording. The color for the layer mask is configurable, which can be Black, Gray, or White.

For example, you can see that an application is hidden during the recording playback:

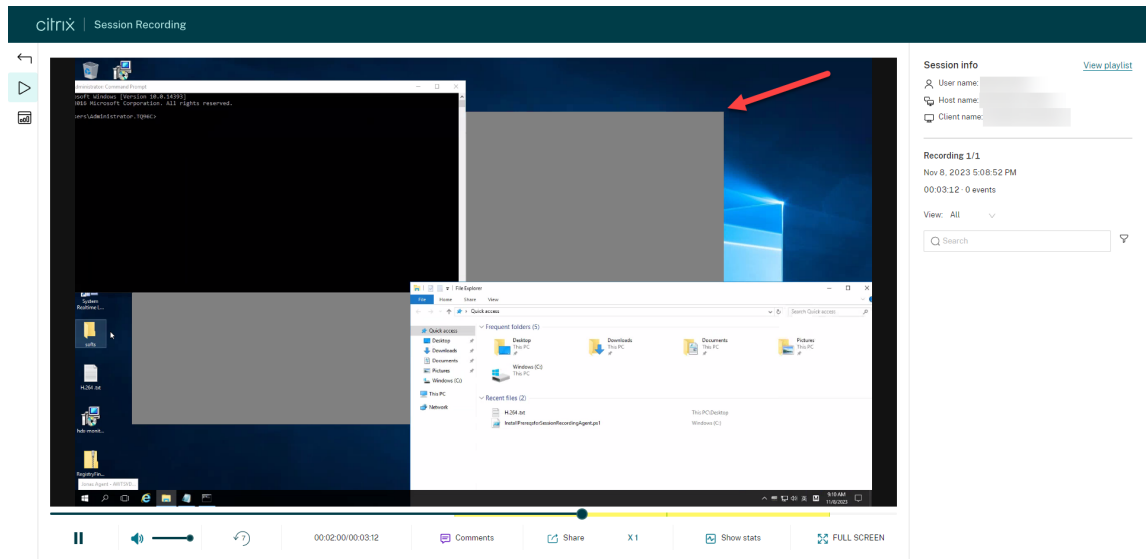

For each rule, choose at least one of the following items to create the rule criteria:

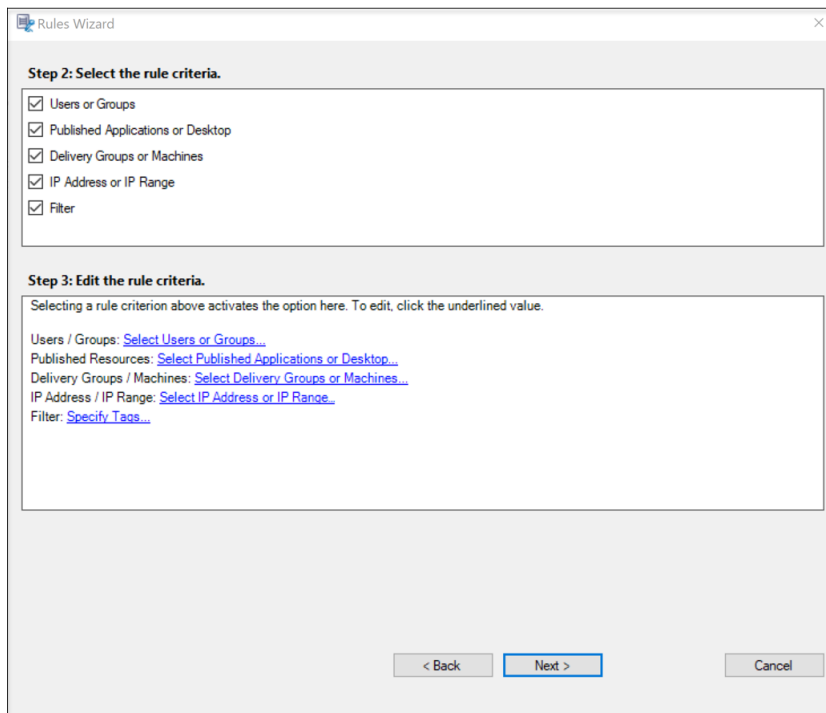

- **Users or Groups.** Creates a list of users or groups to which the action of the rule applies. Session Recording allows you to [use Active Directory groups](#) and [white list users](#).
- **Published Applications or Desktop.** Creates a list of published applications or desktops to which the action of the rule applies. In the **Rules** wizard, choose the Citrix Virtual Apps and Desktops or Citrix DaaS (formerly Citrix Virtual Apps and Desktops service) sites on which the applications or desktops are available.
- **Delivery Groups or Machines.** Creates a list of Delivery Groups or machines to which the action of the rule applies. In the **Rules** wizard, choose the location of the Delivery Groups or machines.
- **IP Address or IP Range.** Creates a list of IP addresses or ranges of IP addresses to which the action of the rule applies. On the **Select IP Address and IP Range** screen, add a valid IP address or IP range for which recording is enabled or disabled. The IP addresses mentioned here are the IP addresses of the Citrix Workspace apps.
- **Filter.** Creates a list of smart access tags to which the action of the rule applies. You can configure contextual access (smart access) using smart access policies on Citrix NetScaler.

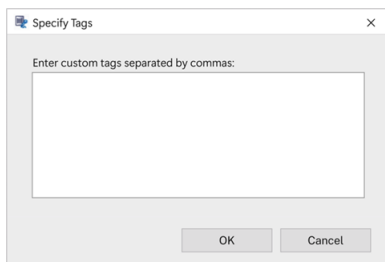
**Note:**

The Session Recording policy console supports configuring multiple criteria within a single rule. When a rule applies, both the “AND” and the “OR” logical operators are used to compute the final action. Generally speaking, the “OR” operator is used between items within a criterion, and the “AND” operator is used between separate criteria. If the result is true, the Session Recording policy engine takes the rule’s action. Otherwise, it goes to the next rule and repeats the process.

When you create more than one rule in a recording policy, some sessions might match the criteria for more than one rule. In these cases, the rule with the highest priority is applied to the sessions.

The recording action of a rule determines its priority:

- Rules with the **Disable session recording** action have the highest priority.
- Rules with the **Enable session recording with notification** action have the second-to-highest priority.
- Rules with the **Enable session recording without notification** action have the second-to-lowest priority.
- Rules with the **Enable event only session recording with notification** action have the medium priority.

- Rules with the **Enable event only session recording without notification** action have the lowest priority.

Some sessions might not meet any rule criteria in a recording policy. For these sessions, the action of the policy fallback rule applies. The action of the fallback rule is always **Disable session recording**. You can't modify or delete the fallback rule.

Steps

To create a custom recording policy:

1. Log on as an authorized Policy Administrator to the server where the Session Recording policy console is installed.
2. Start the Session Recording policy console and select **Recording Policies** in the left pane. From the menu bar, choose **Add New Policy**.
3. Right-click the **New policy** and select **Add Rule**.
4. In the rules wizard, select a recording option and then click **Next**.

Rules Wizard

Step 1: Select a recording option to specify if and how a session is recorded.

Enable session recording with notification
 Enable audio recording
 Enable lossy screen recording

Enable session recording without notification
 Enable audio recording
 Enable lossy screen recording

Enable event only session recording with notification
 Enable event only session recording without notification
 Disable session recording

Step 1-2: Set parameters for screen recording

Hide specific applications during screen recording.

Type the process names of the applications that you want to hide. Separate the process names with a semicolon (;)

Black

< Back Next > Cancel

When you select **Enable session recording with notification** or **Enable session recording without notification**, you can further select to enable audio recording or lossy screen recording.

5. Select the rule criteria - You can choose one or more rule criteria:

- **Users or Groups**
- **Published Applications or Desktop**
- **Delivery Groups or Machines**
- **IP Address or IP Range**
- **Filter**

6. Edit the rule criteria - To edit, click the underlined values. The values are underlined based on the criteria that you chose in the previous step.

Note:

If you choose the **Published Applications or Desktop** underlined value, the **Site Address** is the IP address, a URL, or a machine name if the Controller is on a local network. The **Name of Application** list shows the display name.

When choosing **Published Applications or Desktop** or **Delivery Groups or Machines**, specify the Delivery Controller for your Session Recording policy console to communicate with.

The Session Recording policy console is the only channel to communicate with Delivery Controllers from the Citrix Cloud and on-premises environments.

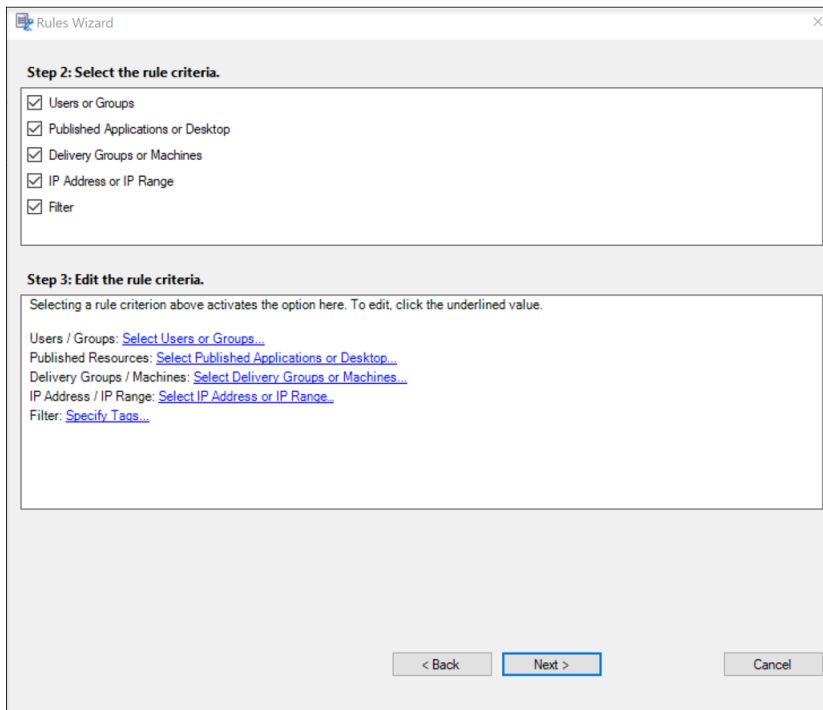

For example, when choosing **Delivery Groups or Machines**, click the corresponding hyperlink in the preceding screenshot and click **Add** to add queries to the Controller.

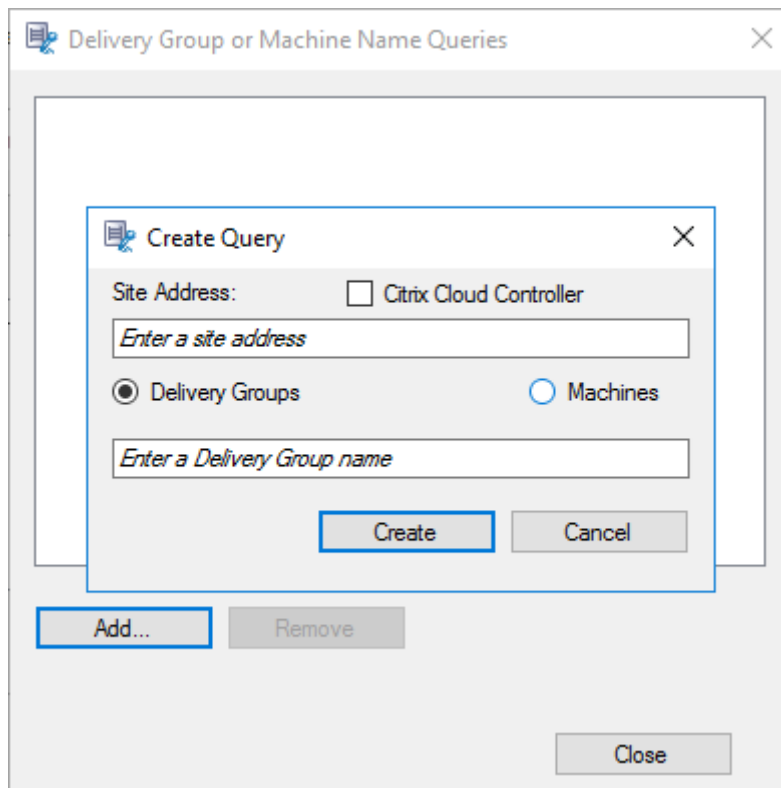

For a description of use cases that cover the on-premises and the Citrix Cloud Delivery Controllers, see the following table:

Use Case	Action Required
On-Premises Delivery Controller	<ol style="list-style-type: none"> a) Install Broker_PowerShellSnapIn_x64.msi. 2. Clear the Citrix Cloud Controller check box.
Citrix Cloud Delivery Controller	<ol style="list-style-type: none"> a) Install the Citrix DaaS Remote PowerShell SDK. 2. Validate the Citrix Cloud account credentials. 3. Select the Citrix Cloud Controller check box.

Use Case	Action Required
Switch from an on-premises Delivery Controller to a Citrix Cloud Delivery Controller	a) Uninstall Broker_PowerShellSnapIn_x64.msi and restart the machine. 2. Install the Citrix DaaS Remote PowerShell SDK. 3. Validate the Citrix Cloud account credentials. 4. Select the Citrix Cloud Controller check box.
Switch from a Citrix Cloud Delivery Controller to an on-premises Delivery Controller	a) Uninstall the Citrix DaaS Remote PowerShell SDK and restart the machine. 2. Install Broker_PowerShellSnapIn_x64.msi. 3. Clear the Citrix Cloud Controller check box.

Validating the Citrix Cloud credentials

To query Delivery Controllers hosted in the Citrix Cloud, manually validate your Citrix Cloud credentials on the machine where the Session Recording policy console is installed. Failure to comply can cause an error and your Session Recording policy console might not work as expected.

To do the manual validation:

- a) Log on to the Citrix Cloud console and locate **Identity and Access Management > API Access**. Create an **API access Secure Client** for obtaining an authentication profile that can bypass the Citrix Cloud authentication prompts. Download your Secure Client, rename, and save it in a safe location. The file name is defaulted to secureclient.csv.

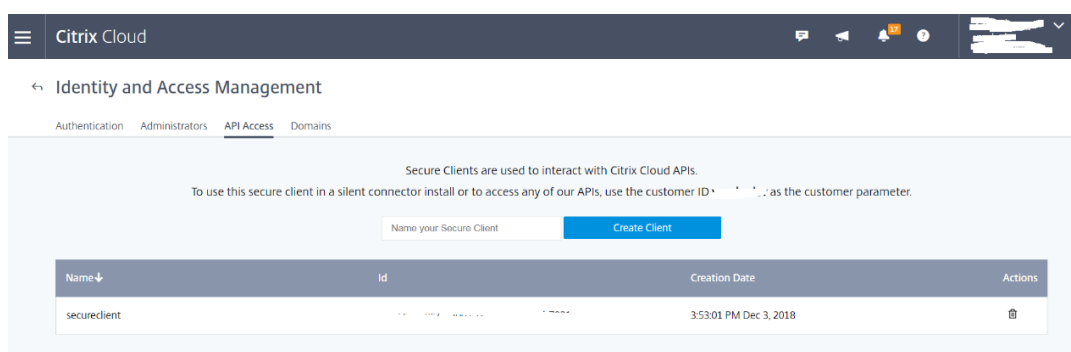

- b) Open a PowerShell session and run the following command to have the authentication profile (obtained in the preceding step) take effect.

```
1 asnp citrix.*
2 Set-XDCredentials -CustomerId "citrixdemo" -SecureClientFile "
  c:\temp\secureclient.csv" -ProfileType CloudAPI - StoreAs "
  default"
```

Set **CustomerId** and **SecureClientFile** as required. The preceding command creates a default authentication profile for the customer `citrixdemo` to bypass authentication prompts in the current and all subsequent PowerShell sessions.

7. Follow the wizard to finish the configuration.

Note: Limitation regarding prelaunched application sessions:

- If the active policy tries to match an application name, it can't match applications that are opened in a prelaunched session. As a result, the prelaunched session can't be recorded.
- If the active policy records every application and session prelaunch is enabled, a recording notification appears when a user logs on to Citrix Workspace app for Windows. The prelaunched (empty) session and any applications to be launched in that session going forward are recorded.

As a workaround, publish applications in separate Delivery Groups according to their recording policies. Do not use an application name as a recording condition. This approach ensures that prelaunched sessions can be recorded. However, notifications still appear.

Use Active Directory groups

Session Recording allows you to use Active Directory groups when creating policies. Using Active Directory groups instead of individual users simplifies the creation and management of rules and policies. For example, if users in your company's finance department are contained in an Active Directory group named **Finance**, you can create a rule that applies to all the group members by selecting the **Finance** group in the **Rules** wizard.

White list users

You can create Session Recording policies ensuring that the sessions of some users in your organization are never recorded. This case is called *white listing* these users. White listing is useful for users who handle privacy-related information or when your organization does not want to record the sessions of a certain class of employees.

For example, if all managers in your company are members of an Active Directory group named **Executive**, you can ensure that sessions of these users are never recorded by creating a rule that disables

session recording for the **Executive** group. While the policy containing this rule is active, no sessions of members of the Executive group are recorded. The sessions of other members of your organization are sessions recorded based on other rules in the active policy.

Configure the Director to use the Session Recording server

You can use the Director console to create and activate the recording policies.

1. For an HTTPS connection, install the certificate to trust the Session Recording server in the Trusted Root Certificates of the Director server.
2. To configure the Director server to use the Session Recording server, run the `C:\inetpub\wwwroot\Director\tools\DirectorConfig.exe /configsessionrecording` command.
3. Type the IP address or FQDN of the Session Recording server and the port number and connection type (HTTP/HTTPS) that the Session Recording agent uses to connect to the Session Recording Broker on the Director server.

Understand rollover behavior

When you activate a policy, the previously active policy remains in effect until the session being recorded ends or the session recording file rolls over. Files roll over when they've reached the maximum size or recording duration. For more information about the rollover thresholds, see [Specify file size for recordings](#).

The following table details what happens when you apply a new recording policy while a session is being recorded and a rollover occurs:

If the previous recording policy was	And the new recording policy is	After a rollover, the recording policy will be
Do not record	Any other policy	No change. The new policy takes effect only when the user logs on to a new session.
Record without notification	Do not record	The recording stops.
Record without notification	Record with notification	Recording continues and a notification message appears.
Record with notification	Do not record	The recording stops.
Record with notification	Record without notification	Recording continues. No message appears the next time a user logs on.

Configure recording viewing policies

December 3, 2024

Session Recording supports role-based access control. You can create recording viewing policies in the Session Recording policy console and add multiple rules to each policy. Each rule helps you select a user or user group as the recording viewer and set whose recordings are visible to the viewer.

Create a custom recording viewing policy

Before you can create recording viewing policies, enable the feature as follows:

1. Log on to the machine hosting the Session Recording server.
2. From the **Start** menu, choose **Session Recording Server Properties**.
3. In **Session Recording Server Properties**, click the **RBAC** tab.
4. Select the **Allow to configure recording viewing policies** check box.

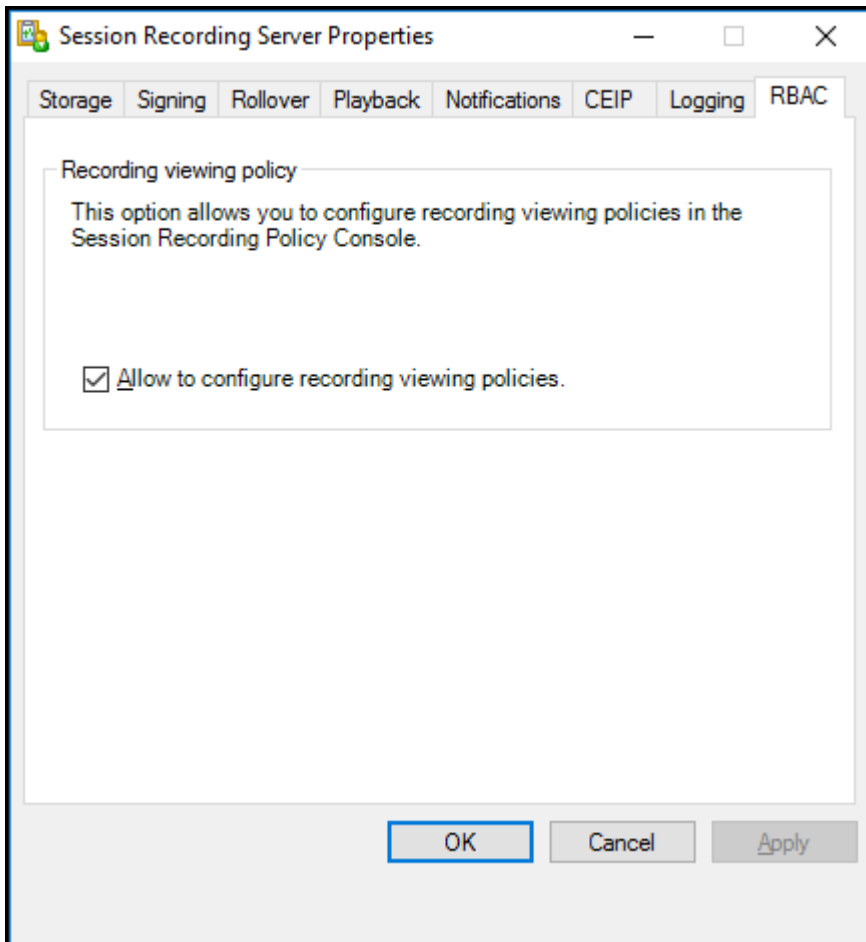

To create a custom recording viewing policy:

Note: Different from recording policies and event detection policies, a recording viewing policy (including all rules added within) is active immediately when it is created. You do not have to activate it.

1. Log on as an authorized Policy Administrator to the server where the Session Recording policy console is installed.
2. Start the Session Recording policy console. By default, there is no recording viewing policy.

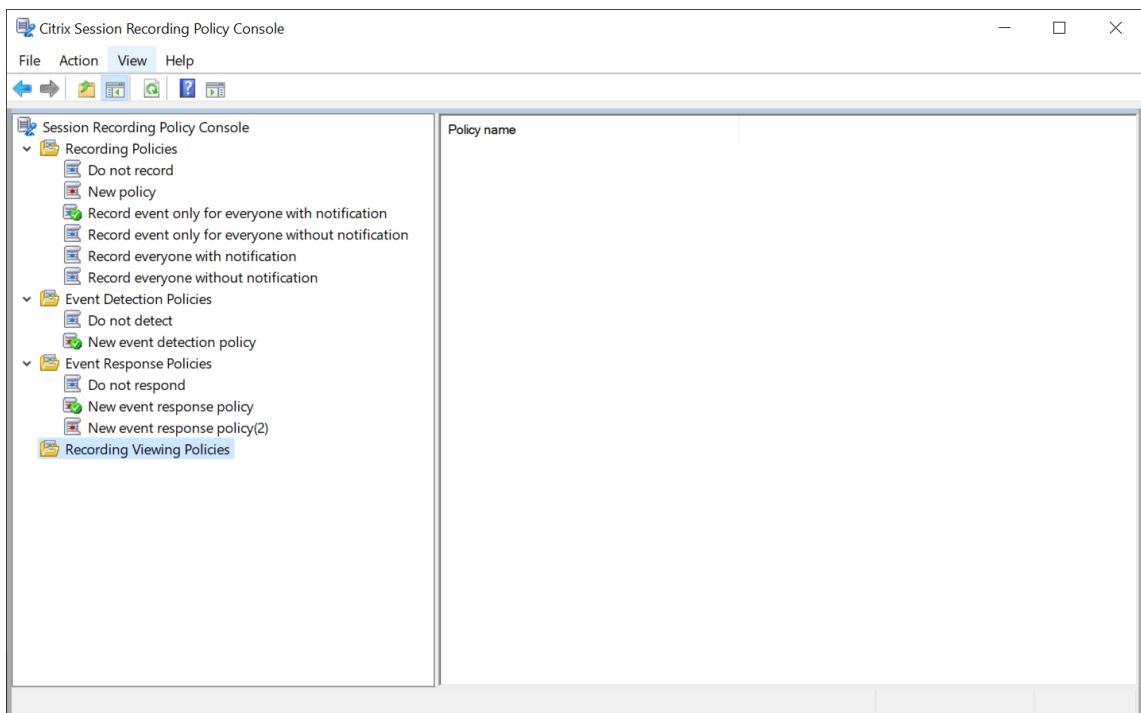

Note: To make **Recording Viewing Policies** available, enable the feature in **Session Recording Server Properties** first.

3. Select **Recording Viewing Policies** in the left pane. From the menu bar, choose **Add New Policy** to create a recording viewing policy.
4. (Optional) Right-click the new policy and rename it.
5. Right-click the new policy and select **Add rule**.

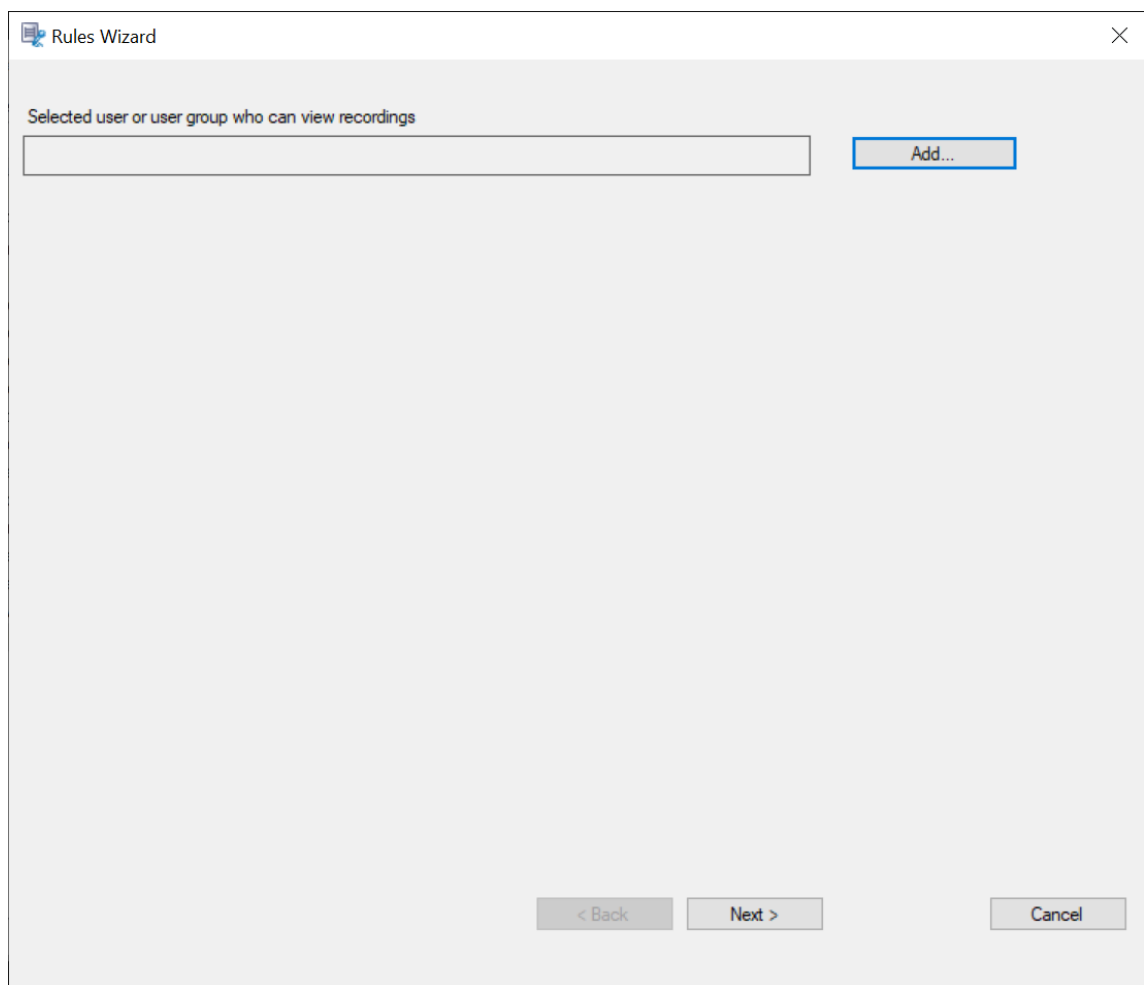

6. Click **Add**.
7. In the **Select Users or Groups** dialog, select a user or user group as the recording viewer.

Note:

A viewer must be assigned the Player role to view recorded sessions. For more information, see [Authorize users](#).

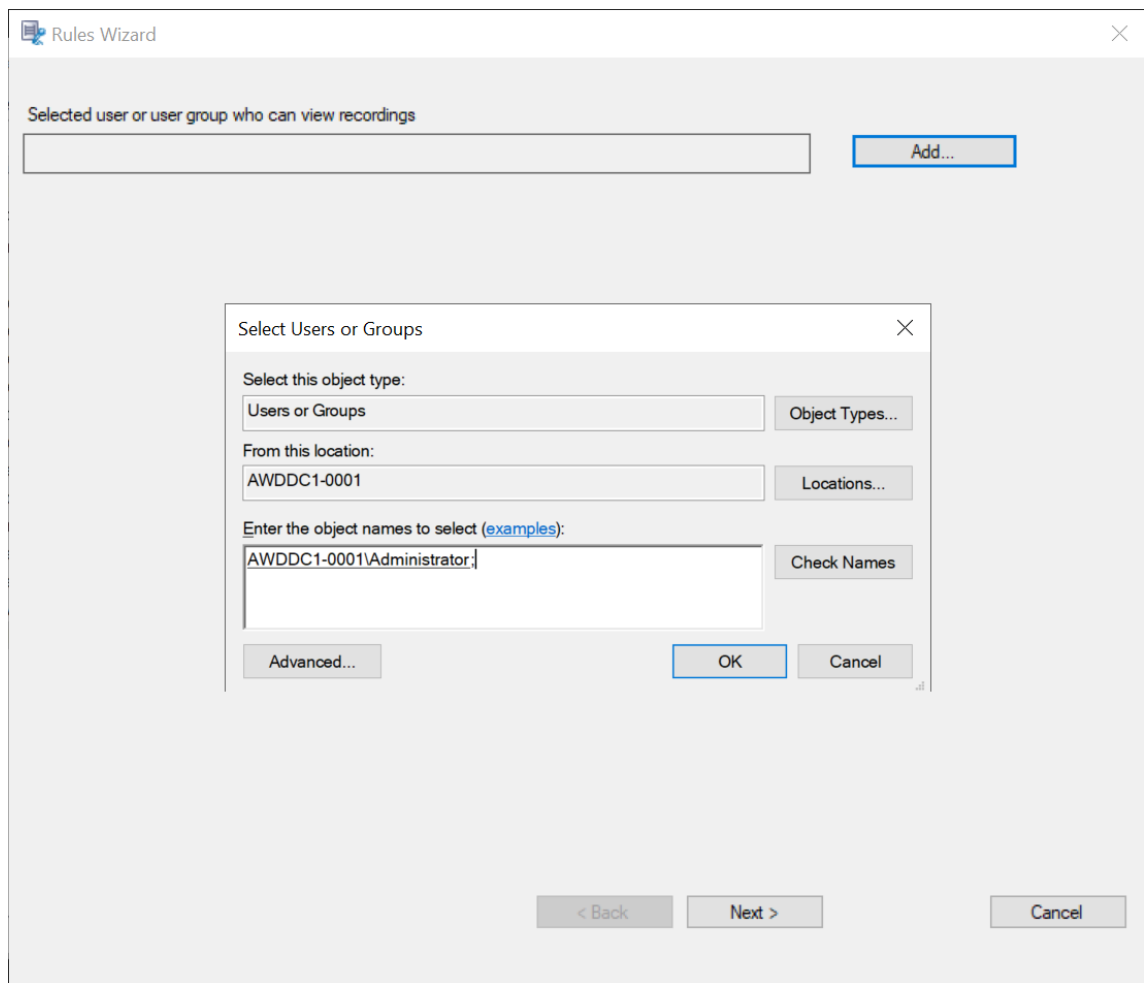
**Note:**

In each rule, you can select only one user or user group as the recording viewer. If you select multiple users or user groups, only your most recent selection takes effect and appears in the text box.

When you specify a recording viewer, ensure that you have assigned the viewer to the Player role. A user without the permission to play recorded sessions receives an error message when trying to play a recorded session. For more information, see [Authorize users](#).

8. Click **OK** and then **Next**. The dialog for setting rule criteria appears.
9. Select and edit the rule criteria to specify whose recordings are visible to the viewer you specified earlier:
 - **Users or Groups**
 - **Published Applications or Desktop**
 - **Delivery Groups or Machines**

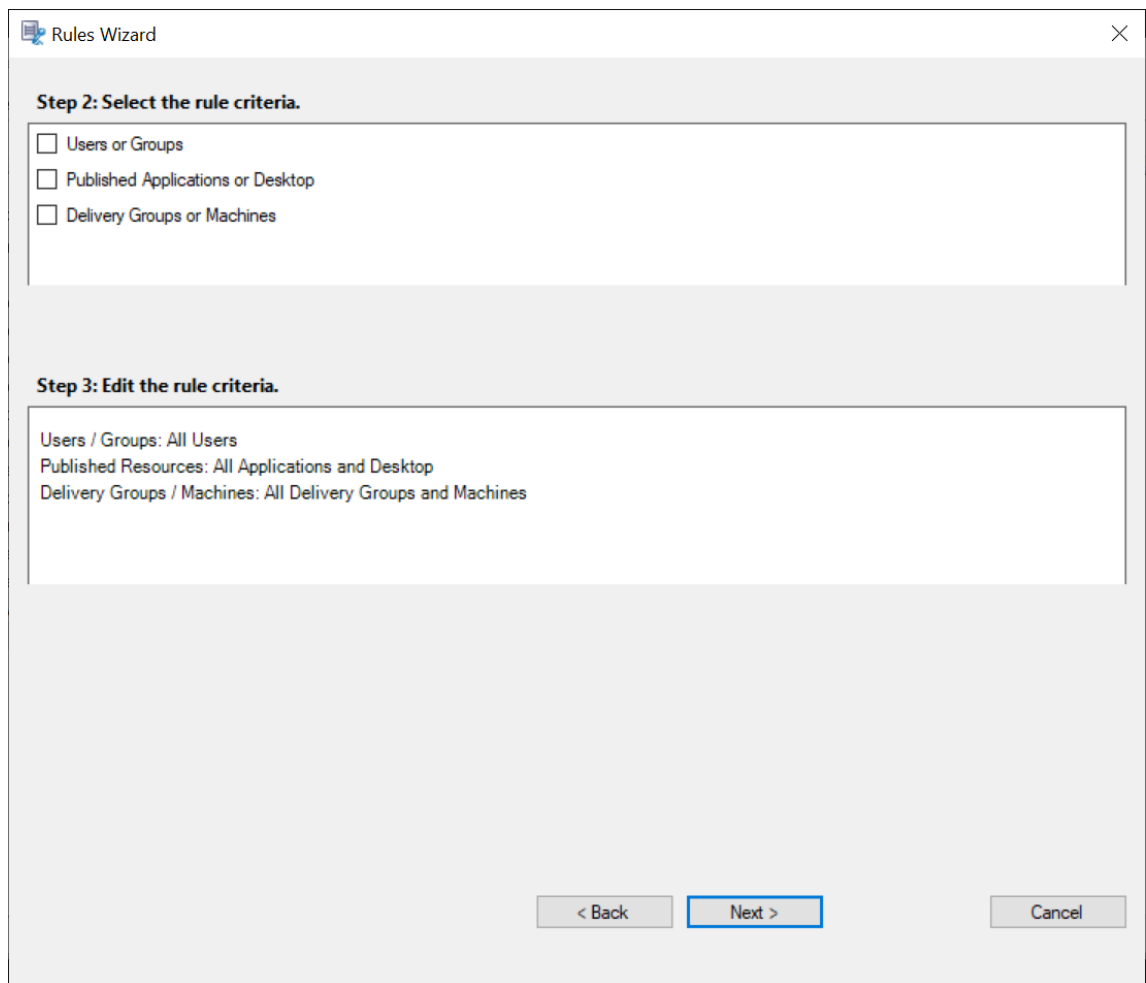

Note:

The “OR” logical operator is used both between items within a rule criterion and between separate rule criteria.

If you leave the rule criteria unspecified, the viewer specified earlier has no recordings to view.

10. Follow the wizard to complete the configuration.

For example:

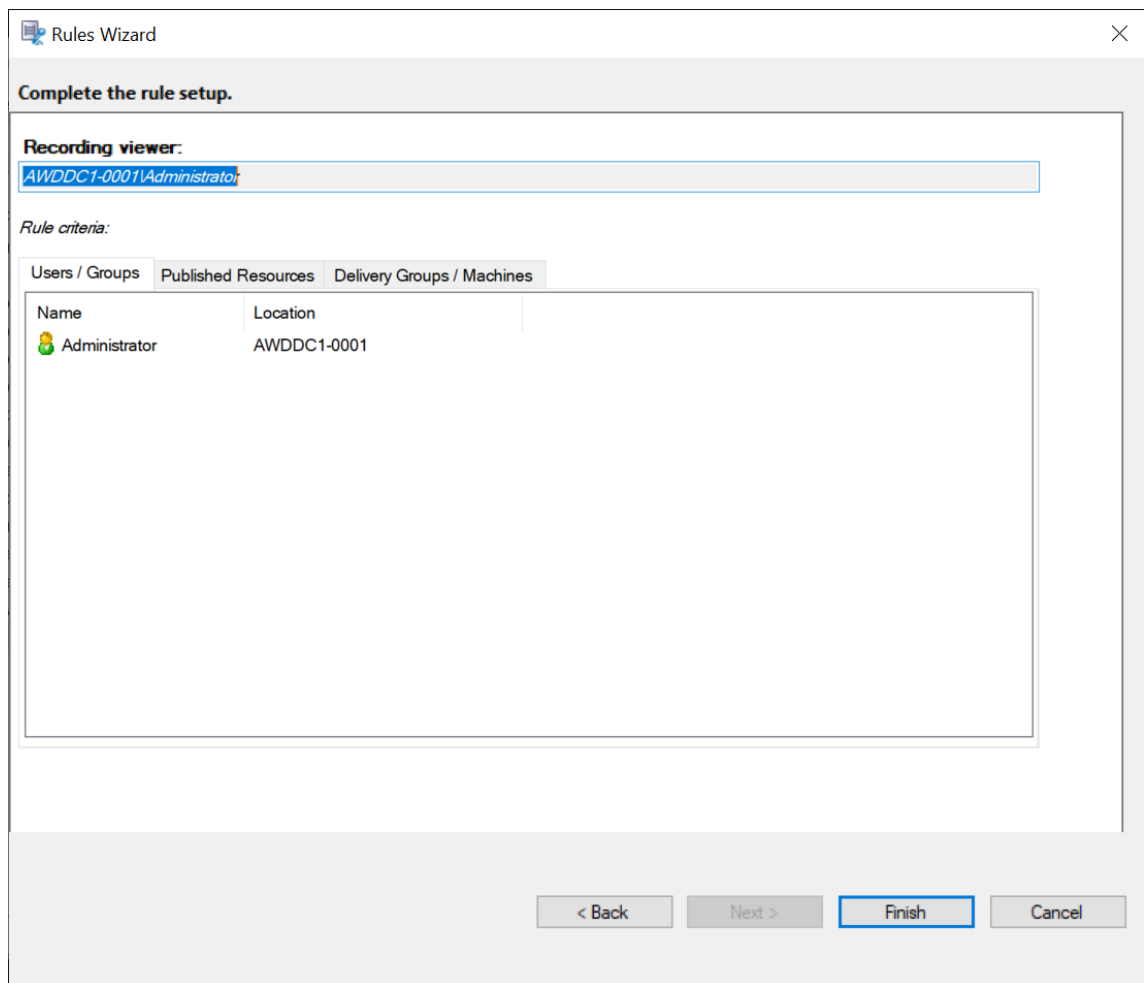

Configure event detection policies

December 3, 2024

Session Recording supports centralized configuration of event detection policies. You can create policies in the Session Recording policy console to log various events.

Events that can be detected

Session Recording detects target events and tags those events in recordings for later search and playback. You can search for events of interest from large amounts of recordings and locate those events during playback.

System-defined events

Session Recording can detect and log the following system-defined events that occur during recorded sessions:

- Insertion of USB mass storage devices
- Application starts and ends
- App failures
- App installs and uninstalls
- File renaming, creation, deletion, and moving operations within sessions
- File transfers between session hosts (VDAs) and client devices (including mapped client drives and generic redirected mass storage devices)
- Web browsing activities
- Topmost window events
- Clipboard activities
- Windows registry modifications
- User account modifications
- RDP connections
- Performance data (data points related to the recorded session)
- Popup window events
- Printing activities

For example:

- Events in an event-only recording in the web player:

Session Recording 2407

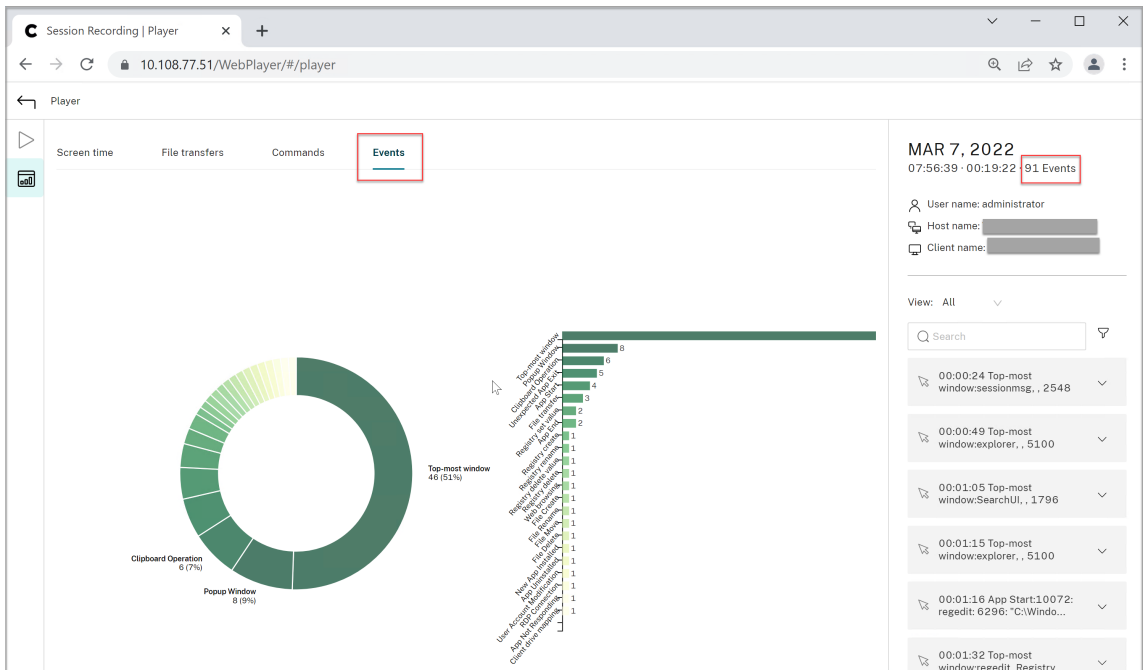

- Events in a screen recording in the web player:

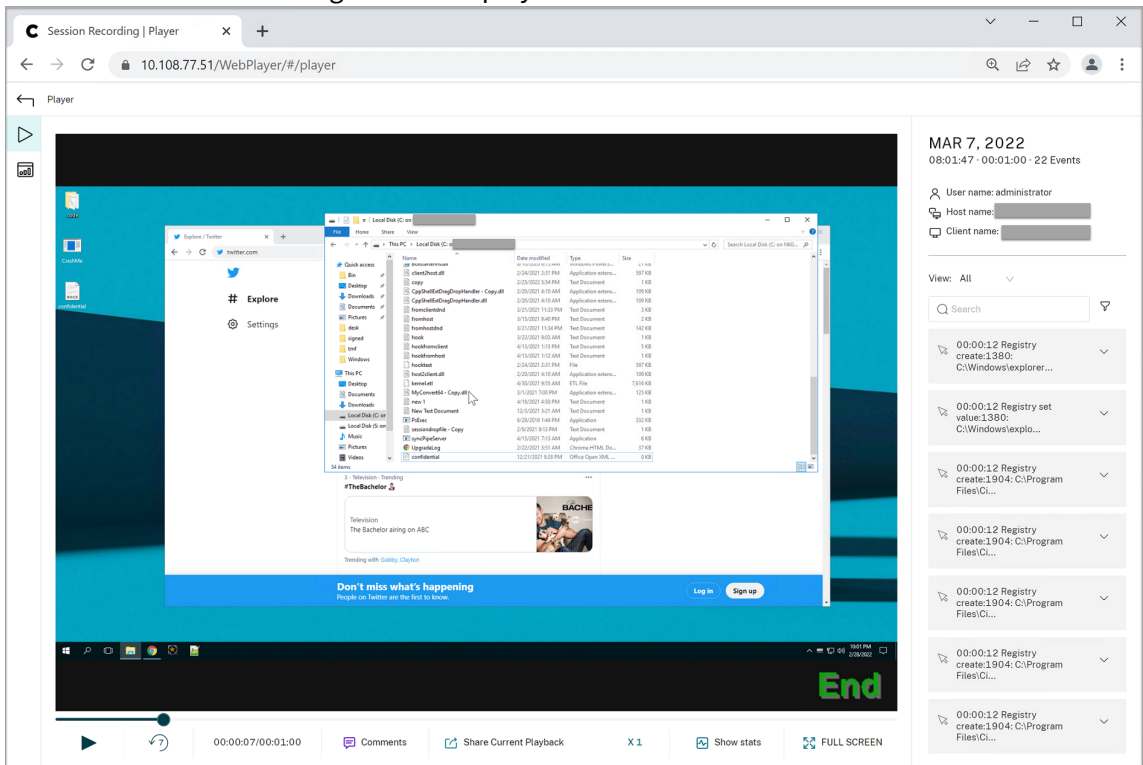

- Events in the Session Recording player:

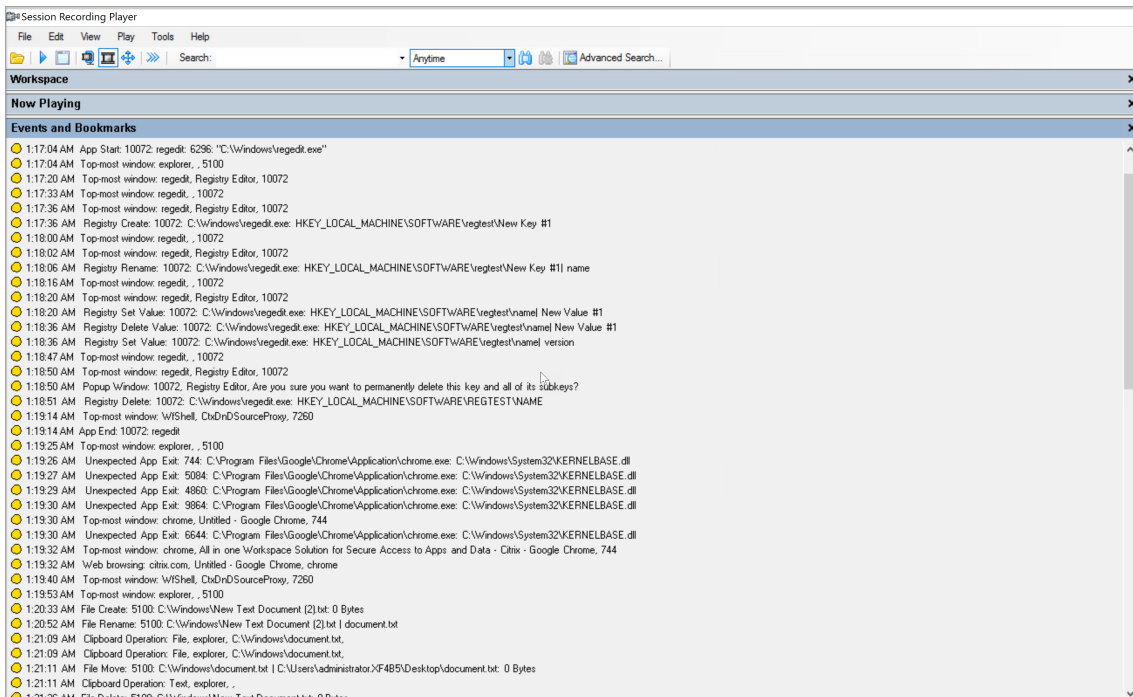

For more events in the Session Recording player, see the event descriptions later in this article.

Note:

Applications built by PowerBuilder might exit unexpectedly when there are active policies detecting web browsing activities and topmost window events. To avoid the issue, use PowerBuilder 2019 R3 to build your applications.

Insertion of USB mass storage devices Session Recording can detect the insertion of a Client Drive Mapping (CDM) mapped or generic redirected USB mass storage device in a client where Citrix Workspace app for Windows or for Mac is installed. Session Recording tags these events in the recording.

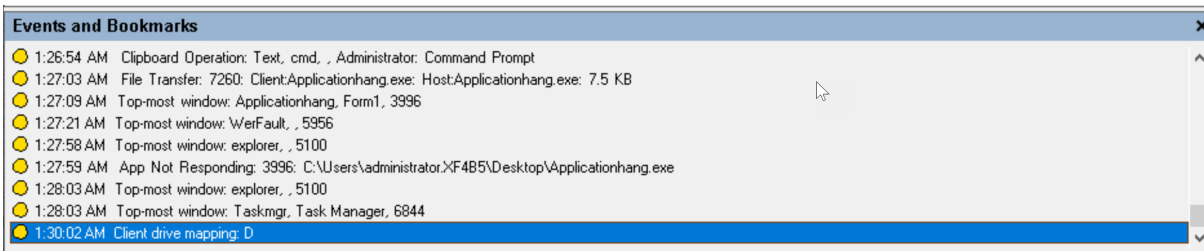

Note:

To use an inserted USB mass storage device and detect the insertion events, set the **Client USB device redirection** policy to **Allowed** in Citrix Studio.

Currently, only the insertion of USB mass storage devices (USB Class 08) can be detected.

Application starts and ends Session Recording supports detection of both application starts and ends. When you add a process to the **App monitoring list**, apps driven by the added process and its child processes are monitored. Child processes of a parent process that starts before Session Recording runs can also be captured.

Session Recording adds the process names, `cmd.exe`, `powershell.exe`, and `wsl.exe`, to the **App monitoring list** by default. If you select **Log app start events** and **Log app end events** for an event detection policy, the starts and ends of the Command Prompt, PowerShell, and Windows Subsystem for Linux (WSL) apps are logged no matter whether you manually add their process names to the **App monitoring list**. The default process names are not visible on the **App monitoring list**.

In addition, Session Recording provides a full command line for each app start event logged.

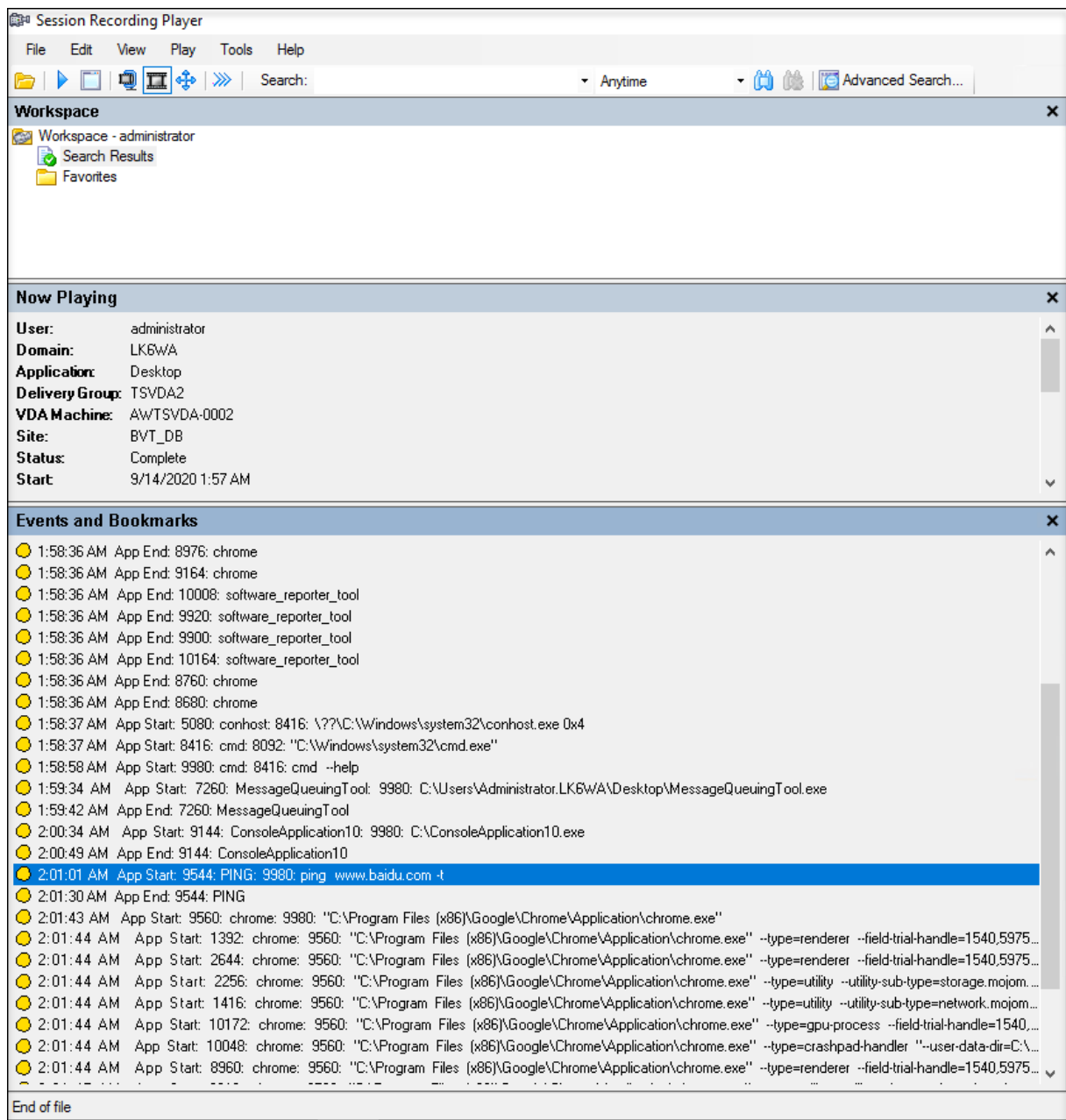

Application failures Session Recording detects app exits and unresponsive apps if you select **Log app failures** when creating your event detection policy. The **Log app failures rule** applies to all apps.

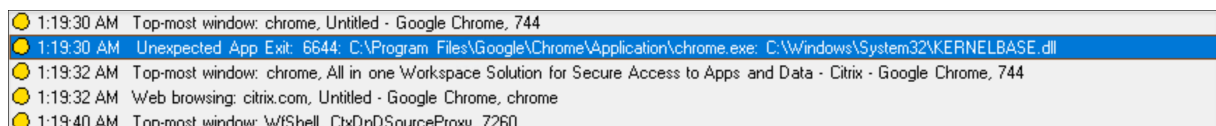

App installs and uninstalls The **Log app installs and uninstalls** rule applies to all apps.

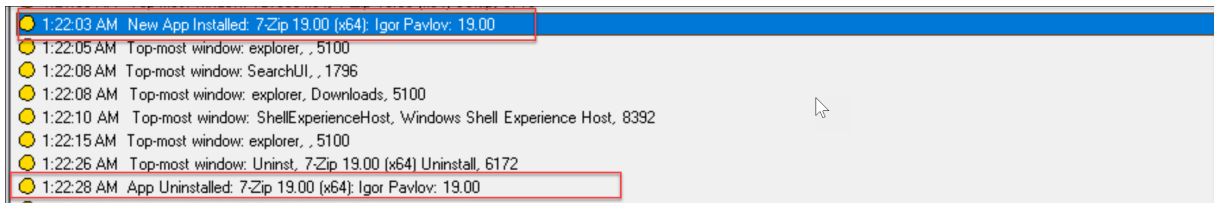

User account modifications Session Recording can detect account creation, enablement, disablement, deletion, name changes, and password modification attempts.

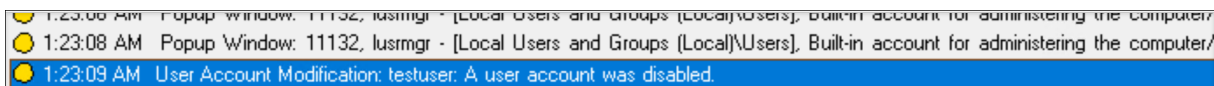

RDP connections Session Recording can detect RDP connections initiated from the VDA hosting the recorded session.

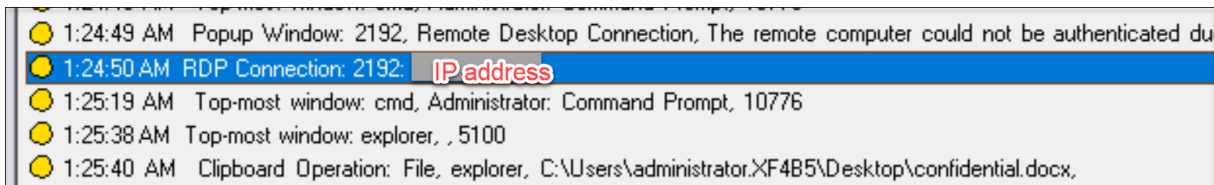

File renaming, creation, deletion, and moving operations within sessions and file transfers between session hosts (VDAs) and client devices Session Recording can detect renaming, creation, deletion, and moving operations on target files and folders that you specify in the **File monitoring list**. Session Recording can also detect file transfers between session hosts (VDAs) and client devices (including mapped client drives and generic redirected mass storage devices). Selecting the **Log sensitive file events** option triggers the detection of file transfers, no matter whether you specify the **File monitoring list**.

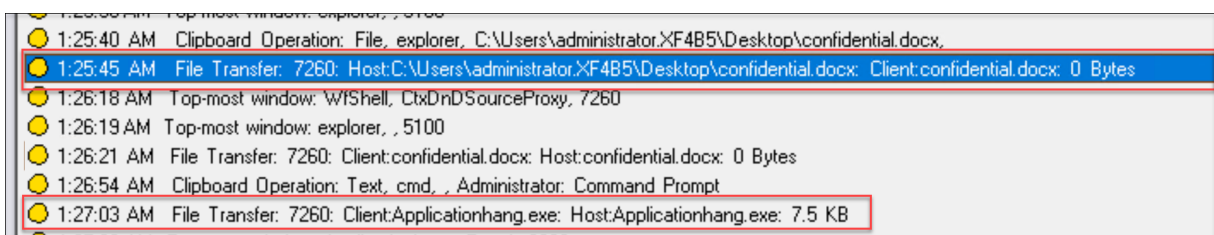
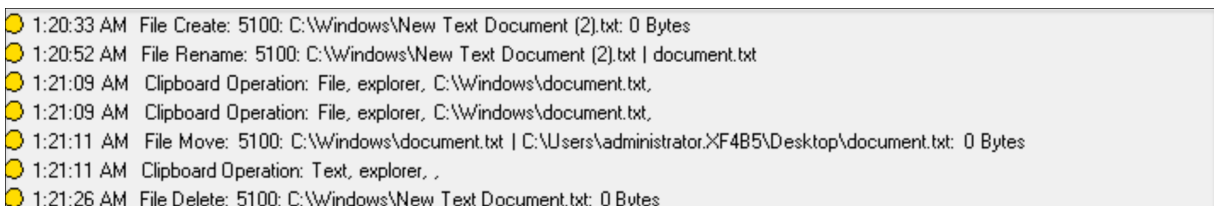

Note:

To enable file drag and drop and capture the drag and drop events, set the **Drag and Drop** policy to **Enabled** in Citrix Studio.

Web browsing activities Session Recording can detect user activities on supported browsers and tag the events in the recording. The browser name, URL, and page title are logged. For an example, see the following screen capture.



When you move your cursor away from a webpage that has focus, your browsing of this webpage is tagged without showing the browser name. This feature can be used to estimate how long a user stays on a webpage. For an example, see the following screen capture.

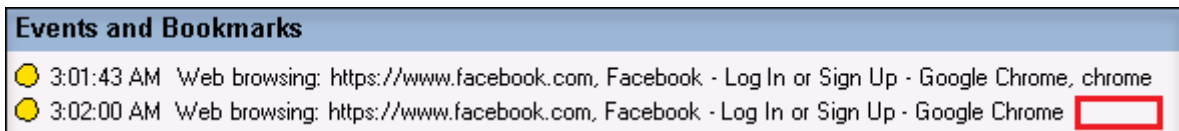

List of supported browsers:

- Google Chrome
- Microsoft Edge Chromium
- Mozilla Firefox

Note:

This feature requires Session Recording Version 1906 or later.

Topmost window events Session Recording can detect the events when the window of an app is on top of all others. The process name, title, and process number are logged.

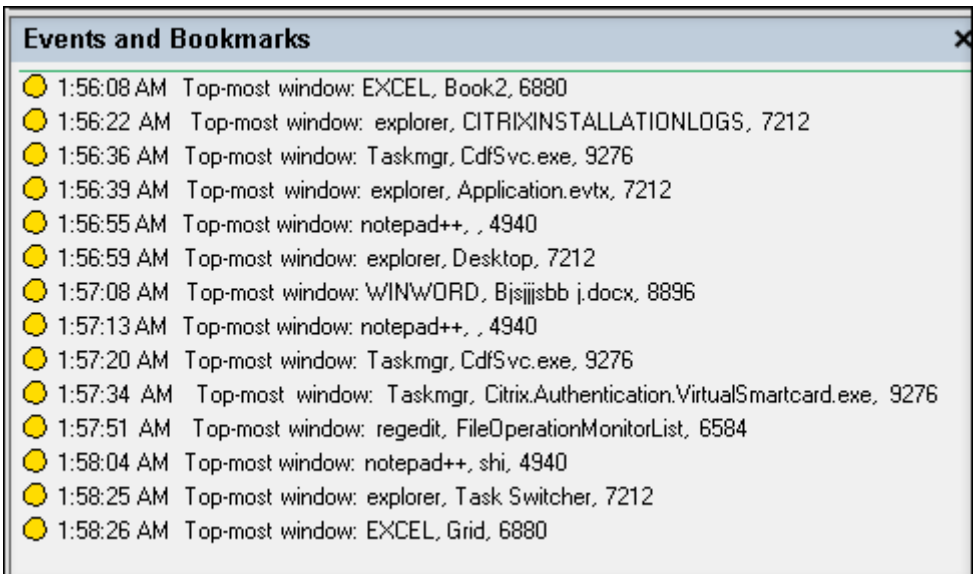

Clipboard activities Session Recording can detect copy operations of text, images, and files using the clipboard. The process name and file path are logged for a file copy. The process name and title are logged for a text copy. The process name is logged for an image copy.

Note: Content of copied text is not logged by default. To log text content, go to the Session Recording agent and set `HKEY_LOCAL_MACHINE\SOFTWARE\Citrix\SmartAuditor\Agent\CaptureClipboardContent` to 1(the default value is 0).

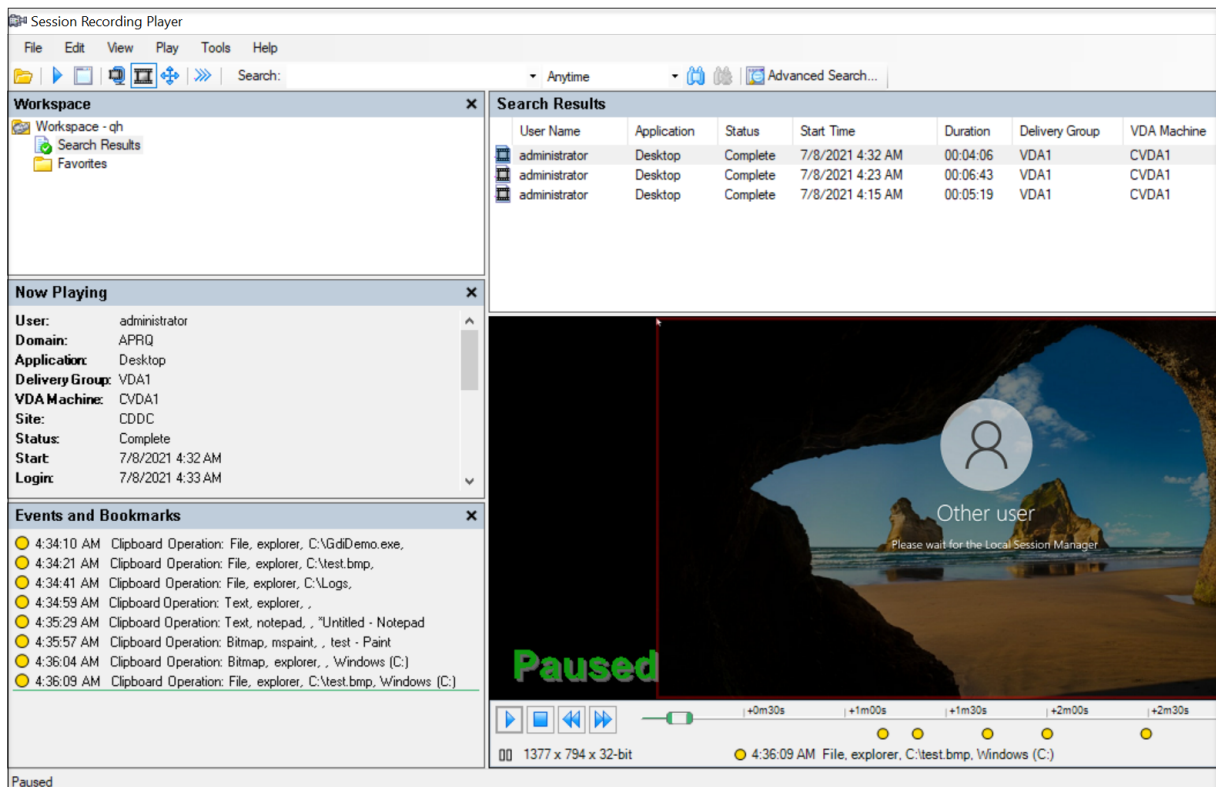

Windows registry modifications Starting with Version 2109, Session Recording can detect and log the following registry modifications while recording sessions:

Registry modification	Corresponding event
Adding a key	Registry Create
Adding a value	Registry Set Value
Renaming a key	Registry Rename
Renaming a value	Registry Delete Value and Registry Set Value
Changing an existing value	Registry Set Value
Deleting a key	Registry Delete
Deleting a value	Registry Delete Value

For example:

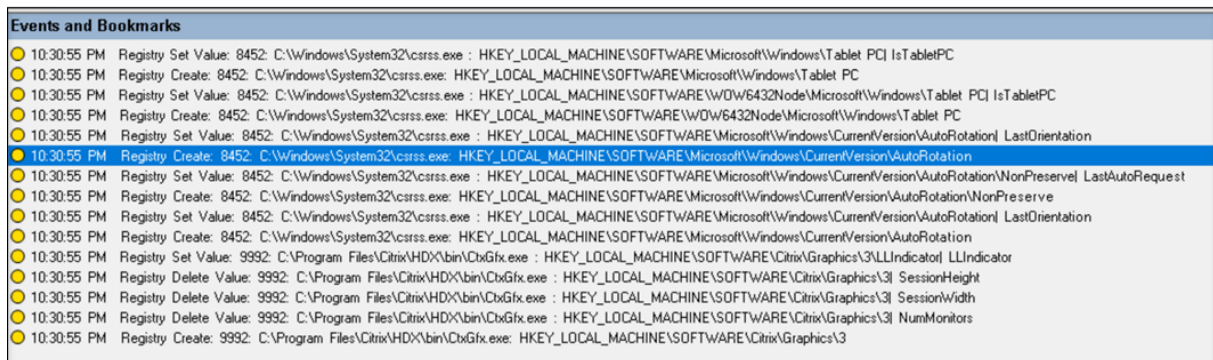

To enable this registry monitoring functionality, select the **Log registry modifications** option for your event detection policy.

Performance data (data points related to the recorded session) When creating your event detection policy, select **Log performance data** to enable the session data overlay feature. The feature introduces a screen overlay during session playback in the web player. It is a semi-transparent overlay that you can relocate and hide. The overlay features the following data points related to the recorded session:

- Round trip time
- Network (send)
- Network (receive)
- CPU usage
- Memory usage

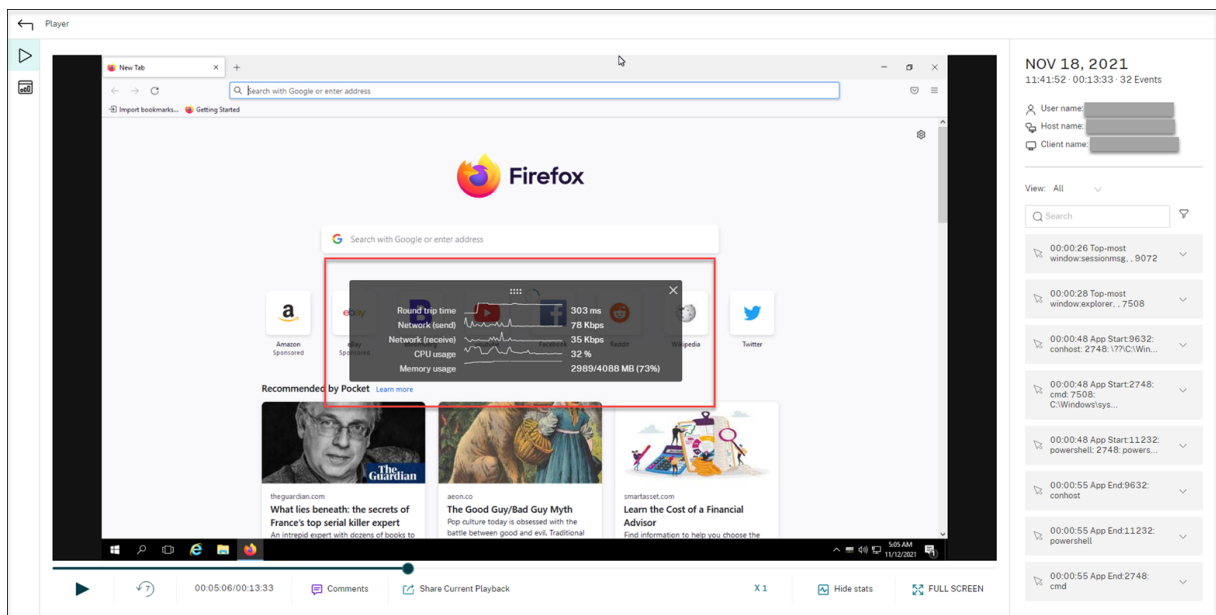

Popup window events When users open or close a confidential file or access a folder, a popup window might appear, showing a prompt or asking for a password. Session Recording can now monitor such popup window events while recording sessions. Popup windows in web browsers are not monitored.

Attributes of a popup window event are recorded, including the process name and content of the prompt.

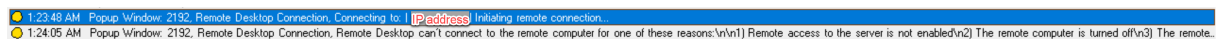

Printing activities (preview) Session Recording monitors printing activities that occur during recorded sessions and tags the printing activities as events in recordings for later search and playback.

Note:

This is a preview feature. It is available with Session Recording version 2407 and later. Preview features might not be fully localized and are recommended for use in non production environments. Citrix Technical Support doesn't support issues found with preview features.

Custom events

The Session Recording agent provides the IUserApi COM interface that third-party applications can use to add application-specific event data into recorded sessions. Based on the event customization, Session Recording can block sensitive information and log the session pause and session resume events accordingly.

Sensitive information blocking Session Recording lets you skip certain periods when recording the screen and blocks sensitive information in these periods during session playback. To use this feature, use Session Recording 2012 and later.

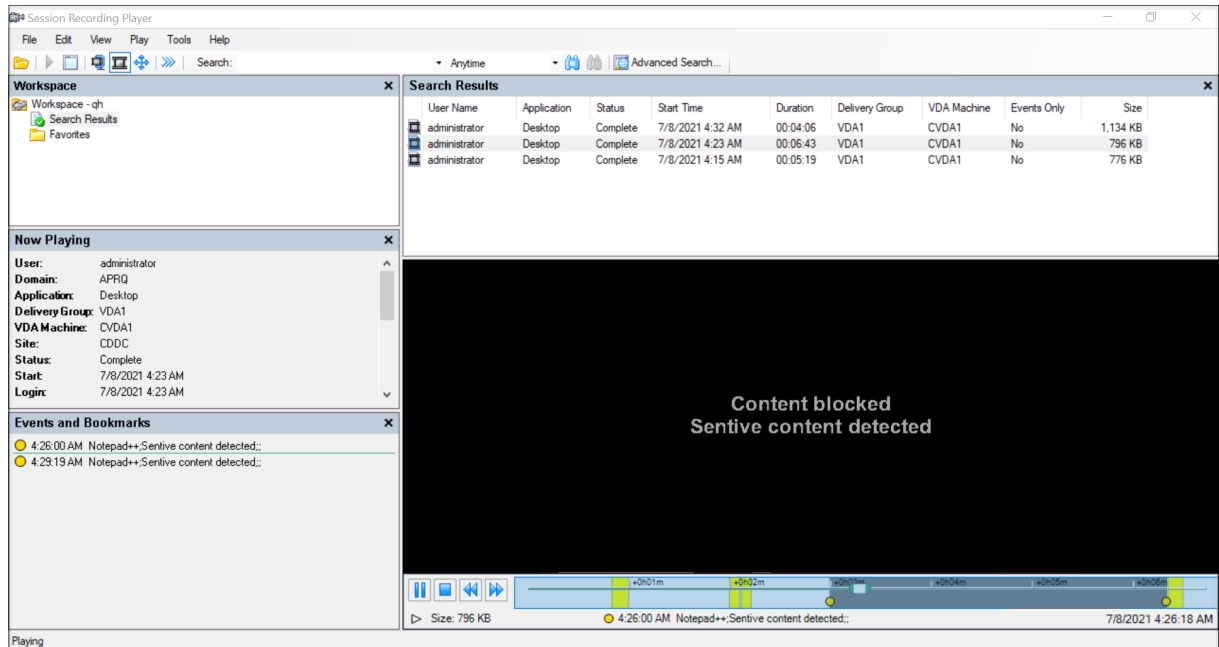

To use this feature, complete the following steps:

1. In **Session Recording Agent Properties**, select the **Allow third party applications to record custom data on this VDA machine** check box and click **Apply**.

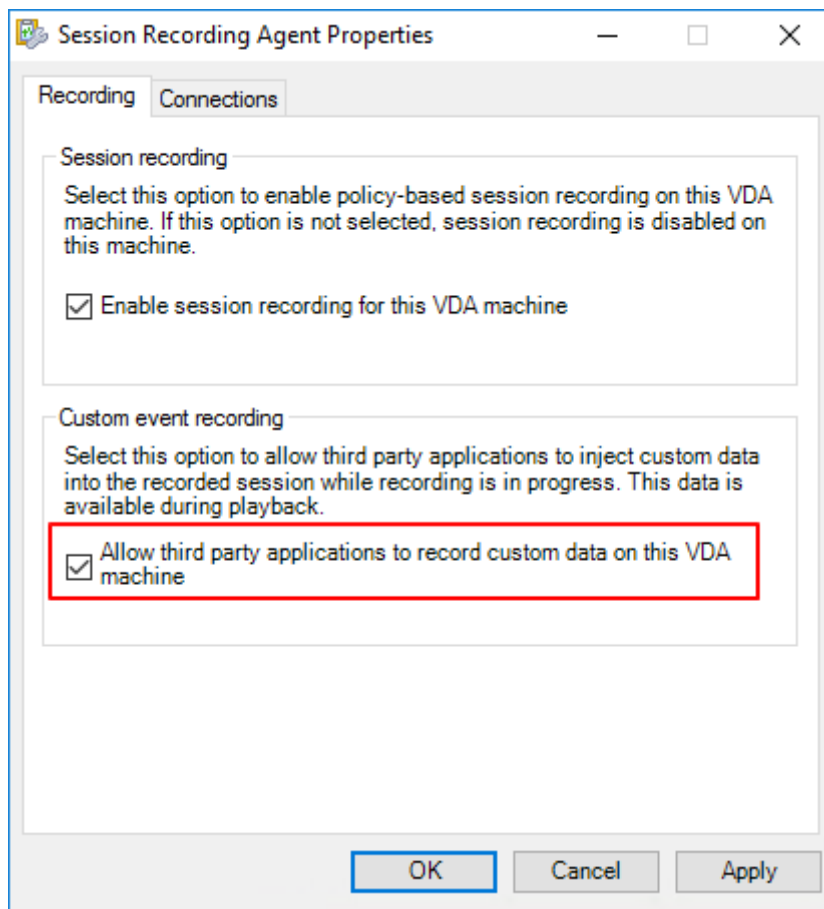

2. Grant users permission to invoke the Session Recording Event API (IUserApi COM interface).

Session Recording adds access control to the event API COM interface starting with version 7.15. Only authorized users are allowed to invoke the functionality to insert event metadata into a recording.

Logon users with local administrator privileges are granted with this permission by default. To grant other users this permission, use the Windows DCOM configuration tool:

- a) On the Session Recording agent, run **comcnfg.exe** to open the Windows DCOM configuration tool.

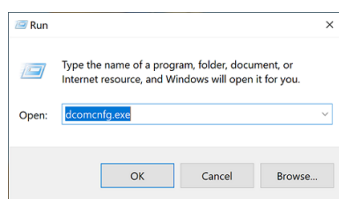

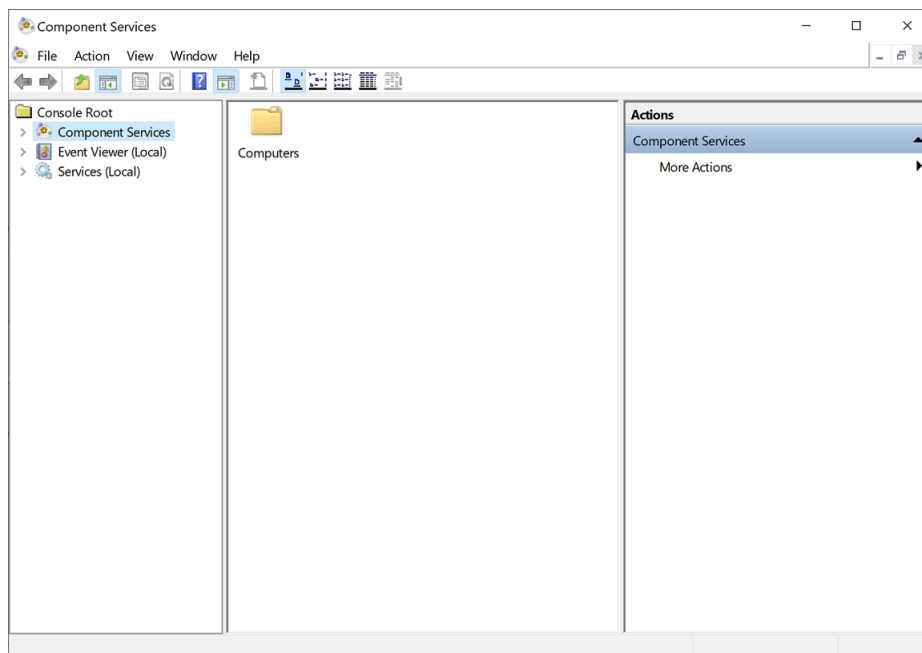

If you are granting permission to users who are not members of the domain administrator group and the Session Recording agent is running on Windows Server 2019 or later, or Windows 10 or later, proceed to step b. Otherwise, skip step b and go to step c directly.

- b) Select **Console Root > Component Services > Computers > My Computer** from the left navigation.

Right-click **My Computer** and select **Properties**.

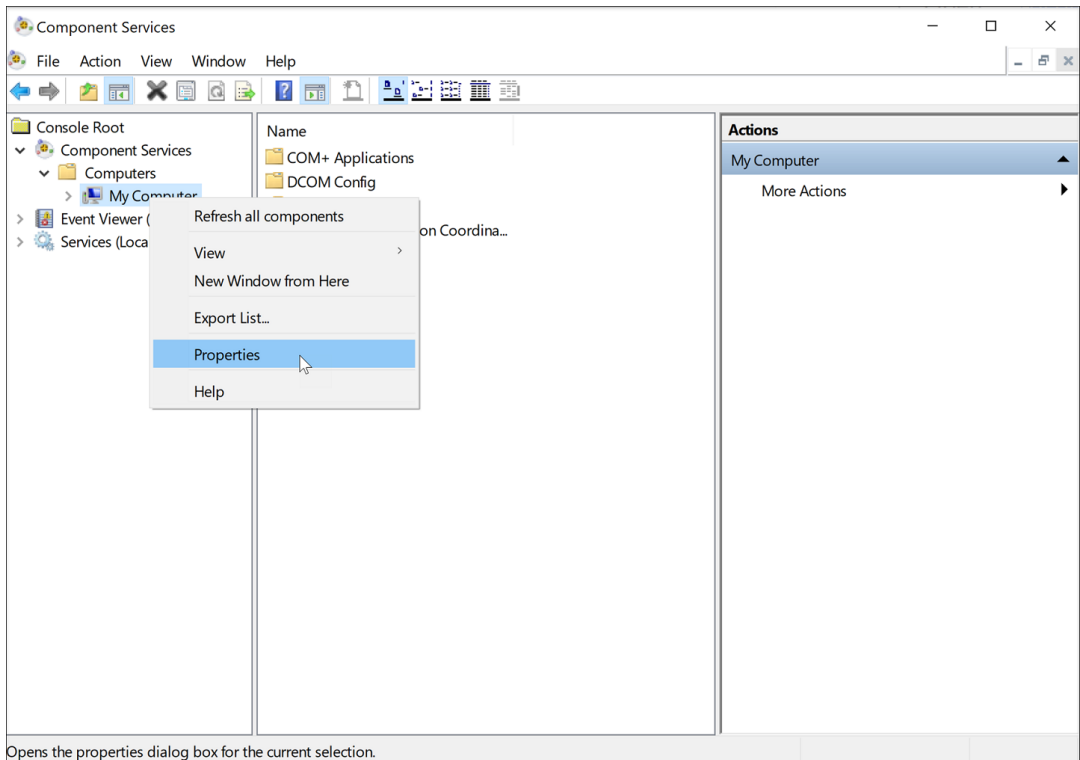

Select the **COM Security** tab, and then click **Edit Default** to add users with **Local Activation** permission in the **Launch and Activation Permissions** section.

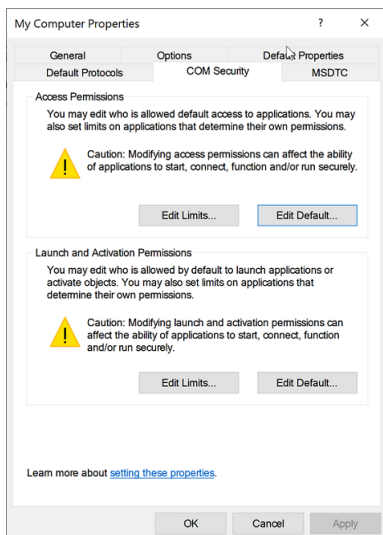

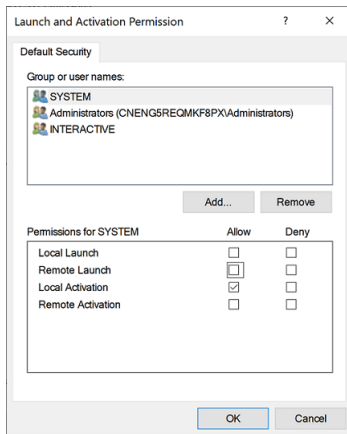

c) Select **Console Root > Component Services > Computers > My Computer > DCOM Config** from the left navigation.

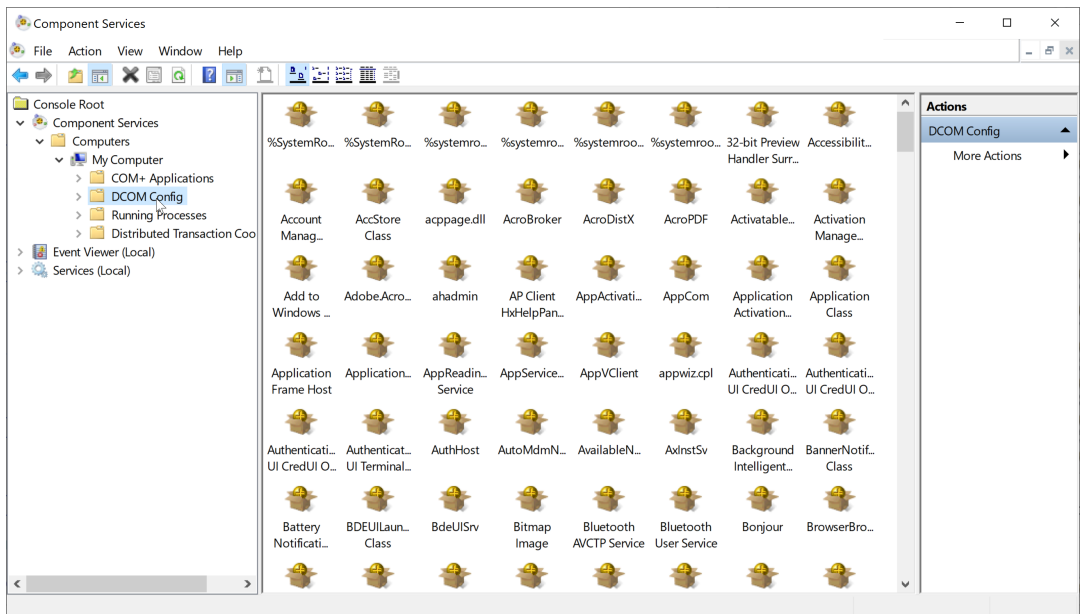

Right-click **Citrix Session Recording Agent** and choose **Properties**.

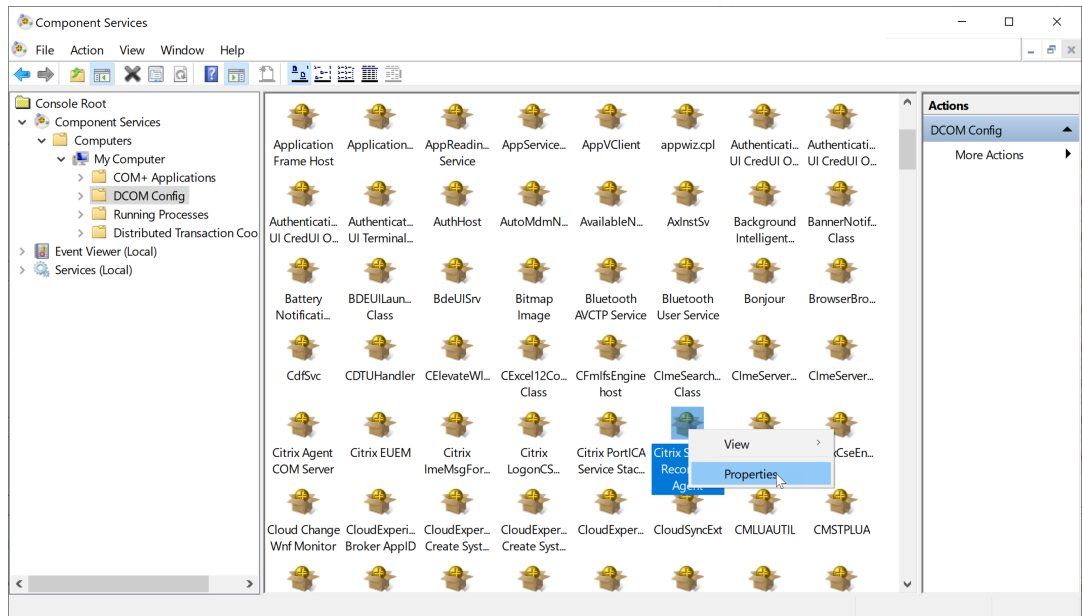

- d) Select the **Security** tab, and then click **Edit** to add users with **Local Activation** permission in the **Launch and Activation Permissions** section.

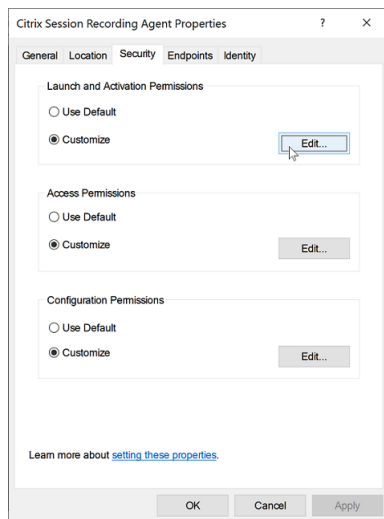

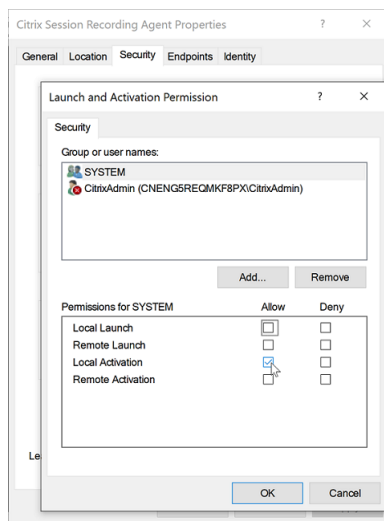

Note:

DCOM configuration takes effect immediately. There is no need to restart any services or the machine.

3. Start a Citrix virtual session.
4. Start PowerShell and change the current drive to the **<Session Recording agent installation path>\Bin** folder to import the SRUserEventHelperSnapin.dll module.
5. Run the `Session-Pause` and `Session-Resume` cmdlets to set parameters for triggering sensitive information blocking.

Parameter	Description	Required or Optional
-APP	The app name that calls the Session-Pause and Session-Resume cmdlets.	Required

Parameter	Description	Required or Optional
-Reason	The reason that content is blocked. If you leave this parameter unspecified, the default setting shows, stating Content Blocked and Sensitive information exists and is blocked . If you set this parameter, the reason you specify shows when you navigate to the blocked period during session playback. This parameter is available for both the Session-Pause and Session-Resume cmdlets.	Optional
-AheadSeconds	This parameter is available for the Session-Pause cmdlet only. It lets you configure the amount of time of the screen recording you want to bypass before sensitive information is detected. The default value is 1 s.	Optional

For example, you can run **Session-Pause** similar to the following:

```

Administrator: PowerShell

SYNTAX
    Session-Pause [-App] <string> [[-Reason] <string>] [<<CommonParameters>>]

DESCRIPTION
    User can use it to pause current session.

RELATED LINKS

REMARKS
    To see the examples, type: "get-help Session-Pause -examples".
    For more information, type: "get-help Session-Pause -detailed".
    For technical information, type: "get-help Session-Pause -full".

PS C:\Program Files\Citrix\SessionRecording\Agent\bin> Session-Pause -App Notepad++ -Reason "Sensitive content detected" -AheadSeconds 2
Getting type from local machine...
Creating instance...
Querying IUserApi interface...
*** Connected ***

Formatting data for send...
Calling IUserApi.LogDataWithExtData...
*** Call Success ***
PS C:\Program Files\Citrix\SessionRecording\Agent\bin>
    
```

Search for and play back recordings with tagged events

Search for recordings with tagged events The Session Recording player allows you to perform advanced searches for recordings with tagged events.

1. In the Session Recording player, click **Advanced Search** on the tool bar or choose **Tools > Advanced Search**.
2. Define your search criteria in the **Advanced Search** dialog box.

The **Events** tab allows you to search for tagged events in sessions by **Event text** or **Event type** or both. You can use the **Events**, **Common**, **Data/Time**, and **Other** filters in combination to search for recordings that meet your criteria.

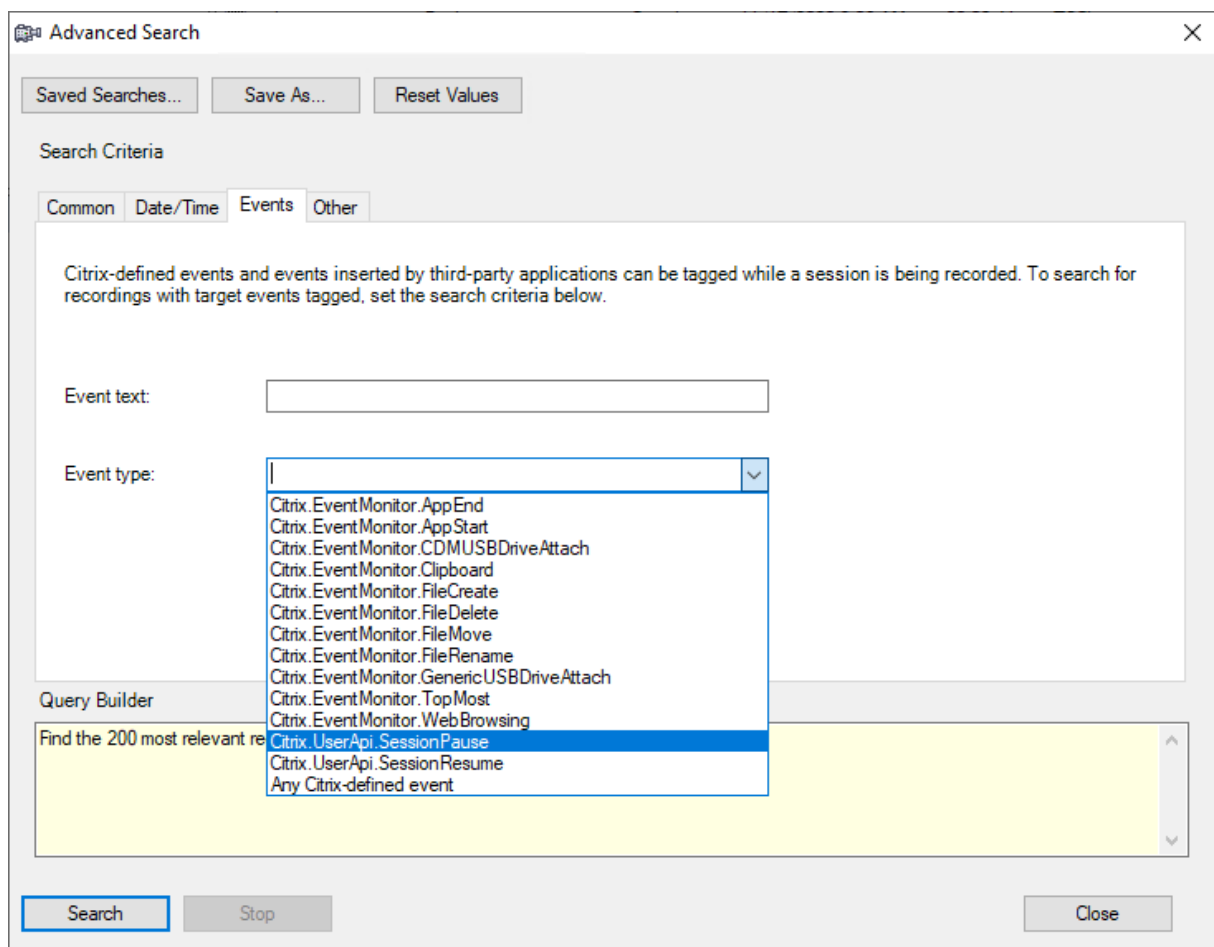

Note:

- The **Event type** list itemizes all event types. You can select an event type to search. Selecting **Any Citrix-defined event** means to search for all recordings with any type of events logged by Citrix Session Recording.
- The **Event text** filter supports partial match. Wildcards are not supported.

- The **Event text** filter is case-insensitive when matching.
- For the types of events, the words **App Start**, **App End**, **Client drive mapping**, and **File Rename** do not participate in matching when you search by **Event text**. Therefore, when you type **App Start**, **App End**, **Client drive mapping**, or **File Rename** in the **Event text** box, no result can be found.

You can use events to navigate through a recorded session, or skip to the points where the events are tagged.

System-defined event detection policy

The system-defined event detection policy is **Do not detect**. It's inactive by default. When it's active, no events are logged.

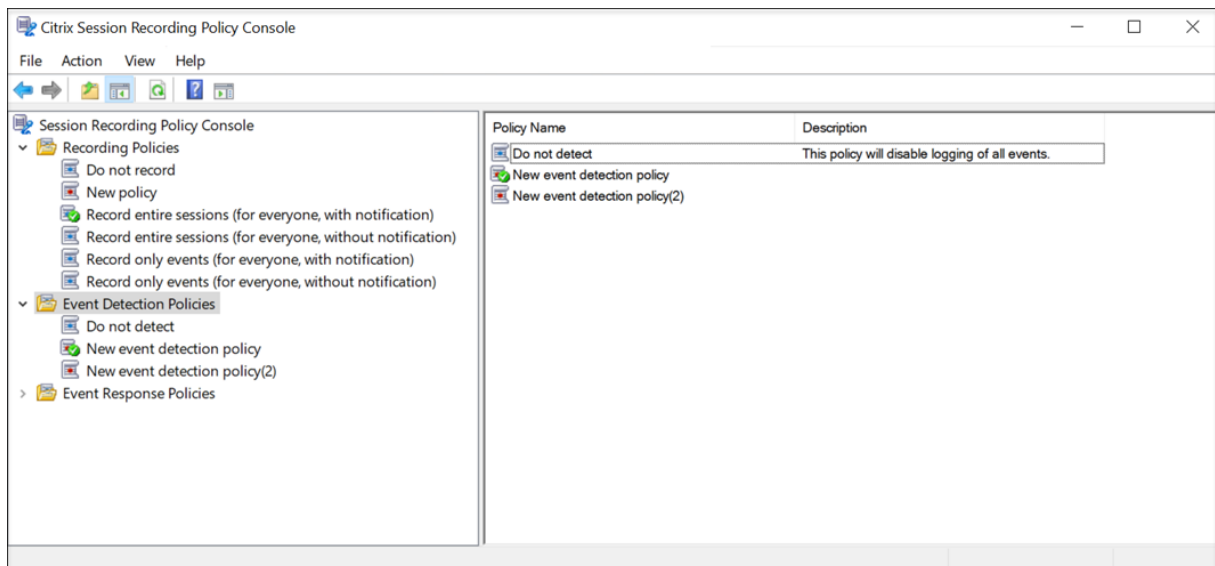

You cannot modify or delete the system-defined event detection policy.

Create a custom event detection policy

Considerations

You can specify which events to log. A wizard within the Session Recording policy console helps you create rules. For each rule you create, you select the events to log and specify which sessions the rule applies to through the rule criteria settings.

For each rule, choose at least one of the following items to create the rule criteria:

- **Users or Groups.** Creates a list of users or groups to which the rule applies.

- **Published Applications or Desktop.** Creates a list of published applications or desktops to which the rule applies.
- **Delivery Groups or Machines.** Creates a list of Delivery Groups or machines to which the rule applies.
- **IP Address or IP Range.** Creates a list of IP addresses or ranges of IP addresses to which the rule applies. The IP addresses mentioned here are the IP addresses of the Citrix Workspace apps.
- **Filter.** Creates a list of smart access tags to which the rule applies. You can configure contextual access (smart access) using smart access policies on Citrix NetScaler.

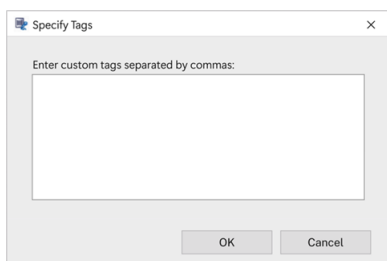

Contextual access (smart access) is available for Session Recording 2402 and later. It lets you apply policies based on the user access context including:

- The user's location
- IP address range
- Delivery group
- Device type
- Installed applications

Steps

To create a custom event detection policy:

1. Log on as an authorized Policy Administrator to the server where the Session Recording policy console is installed.
2. Start the Session Recording policy console.
By default, there is no active event detection policy.
3. Select **Event Detection Policies** in the left pane. From the menu bar, choose **Add New Policy** to create an event detection policy.
4. (Optional) Right-click the new event detection policy and rename it.

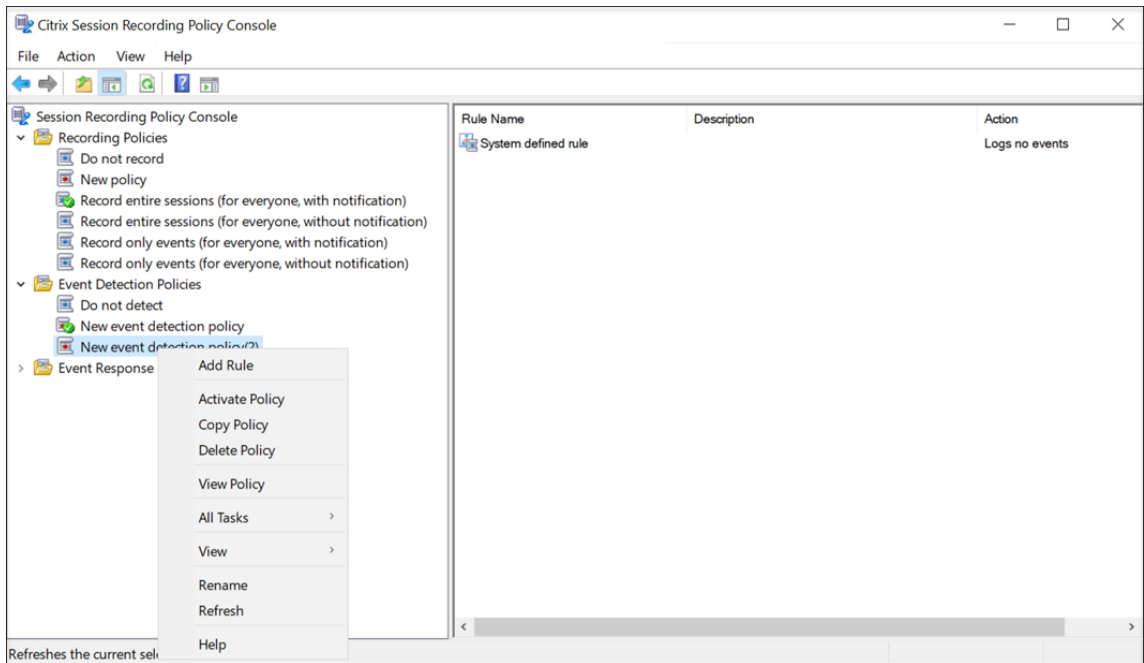

5. Right-click the new event detection policy and select **Add Rule**.
 - a) Specify one or more target events to monitor by selecting the check box next to each event type. Scroll down the window to view all available event types.

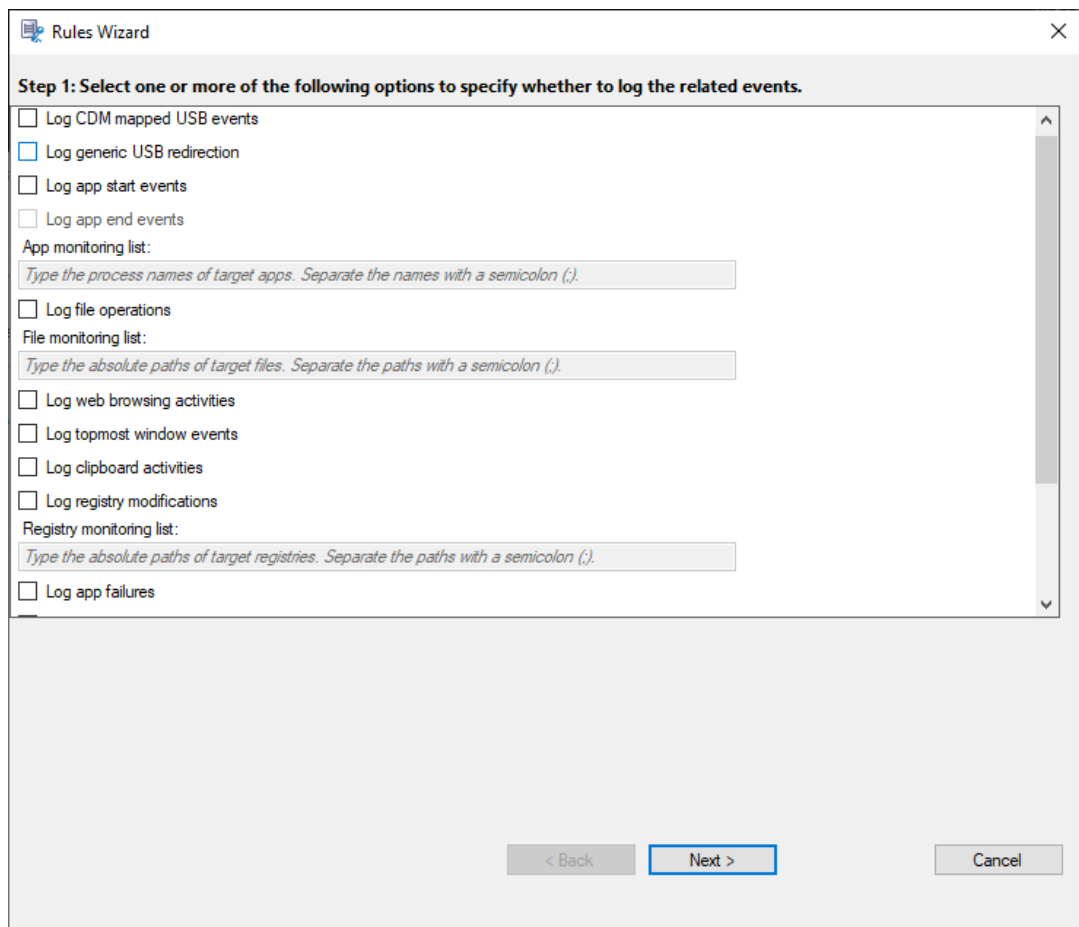

- **Log CDM mapped USB events:** Logs the insertion of a Client Drive Mapping (CDM) mapped mass storage device in a client where Citrix Workspace app for Windows or for Mac is installed.
- **Log generic USB redirection:** Logs the insertion of a generic redirected mass storage device in a client where Citrix Workspace app for Windows or for Mac is installed.
- **Log app start events:** Logs the starts of target applications.
- **Log app end events:** Logs the ends of target applications.

Note:

The **Log app end events** check box is grayed out before you select **Log app start events**.

- **App monitoring list:** When you select **Log app start events** and **Log app end events**, use the **App monitoring list** to specify target applications to monitor and to avoid an excessive number of events from flooding the recordings.

Note:

- To capture the start and end of an application, add the process name of the application in the **App monitoring list**. For example, to capture the start of Remote Desktop Connection, add the process name `mstsc.exe` to the **App monitoring list**. When you add a process to the **App monitoring list**, applications driven by the added process and its child processes are monitored. Session Recording adds the process names, `cmd.exe`, `powershell.exe`, and `wsl.exe`, to the **App monitoring list** by default. If you select **Log app start events** and **Log app end events** for an event detection policy, the starts and ends of the Command Prompt, PowerShell, and Windows Subsystem for Linux (WSL) apps are logged regardless of whether you manually add their process names to the **App monitoring list**. The default process names aren't visible on the **App monitoring list**.
- Separate process names with a semicolon (;).
- Only the exact match is supported. Wildcards aren't supported.
- Process names you add are case-insensitive.
- To avoid an excessive number of events from flooding the recordings, do not add any system process names (for example, `explorer.exe`) and web browsers in the registry.

- **Log file operations:** Logs operations on target files in the **File monitoring list** and logs file transfers between session hosts (VDAs) and client devices (including mapped client drives and generic redirected mass storage devices). Selecting this option triggers the logging of file transfers, no matter whether the **File monitoring list** is specified.

- File events presented in the web player

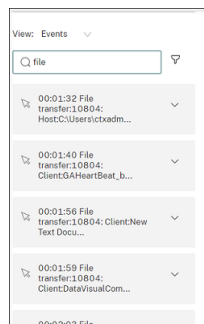

- File events presented in the Session Recording Player

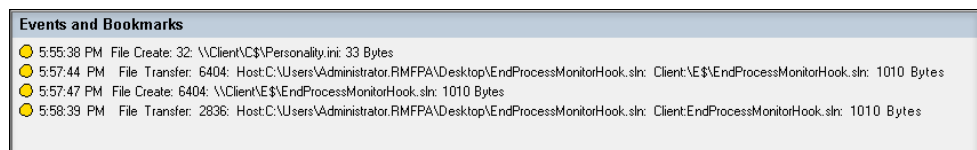

- **File monitoring list:** When you select **Log file operations**, use the **File monitoring list** to specify target files to monitor. You can specify folders to capture all files within them. No file is specified by default, which means no file is captured by default.

Note:

- To capture renaming, creation, deletion, or moving operations on a file, add the path string of the file folder (not the file name or the root path of the file folder) in the **File monitoring list**. For example, to capture renaming, creation, deletion, and moving operations on the `sharing.ppt` file in `C:\User\File`, add the path string `C:\User\File` in the **File monitoring list**.
- Both local file paths and remote shared folder paths are supported. For example, to capture operations on the `RemoteDocument.txt` file in the `\\remote.address\Documents` folder, add the path string `\\remote.address\Documents` in the **File monitoring list**.
- Separate monitored paths with a semicolon (;).
- Only exact matches are supported. Wildcards aren't supported.
- Path strings are case-insensitive.

Limitations:

- Copying files or folders from a monitored folder to an unmonitored folder isn't captured.
 - When the length of a file or folder path including the file or folder name exceeds 260 characters, operations on the file or folder aren't captured.
 - Pay attention to the database size. To prevent large numbers of events from being captured, back up or delete the "Event" table regularly.
 - When large numbers of events are captured in a short time, the player displays and the database stores only one event for each type to avoid storage expansion.
- **Log web browsing activities:** Logs user activities on supported browsers and tags the browser name, URL, and page title in the recording.



List of supported browsers:

- Google Chrome
 - Microsoft Edge Chromium
 - Mozilla Firefox
- **Log topmost window events:** Logs the topmost window events and tags the process name, title, and process number in the recording.

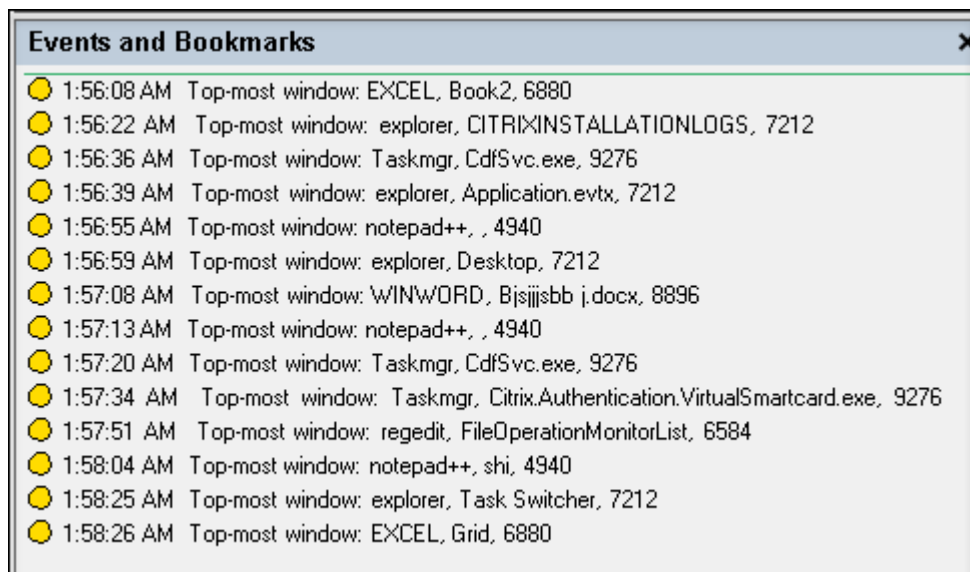

- **Log clipboard activities:** Logs copy operations of text, images, and files using the clipboard. The process name and file path are logged for a file copy. The process name and title are logged for a text copy. The process name is logged for an image copy.
- **Log registry modifications:** Logs the following Windows registry modifications: add a key or value, rename a key or value, change an existing value, and delete a key or value.
- **Registry monitoring list:** When you select **Log registry modifications**, type the absolute paths of the registries you want to monitor and separate the paths with a semicolon (;). Start a path with HKEY_USERS, HKEY_LOCAL_MACHINE, or HKEY_CLASSES_ROOT. For example, you can type `HKEY_LOCAL_MACHINE\SOFTWARE\Microsoft\Windows;HKEY_CLASSES_ROOT\GuestStateVDev`. If you leave this list unspecified, no registry modification is captured.
- **Log app failures:** Logs unexpected app exits and unresponsive apps. This rule applies to all apps.
- **Log user account modifications:** Logs the following user account modifications: account creation, enablement, disablement, deletion, lockout, name changes, and password modification attempts.
- **Log RDP connections:** Logs RDP connections initiated from the VDA hosting the recorded session.
- **Log app installs and uninstalls:** Logs app installs and uninstalls during the recorded session. This rule applies to all apps.
- **Log performance data:** Enables the session data overlay feature. Select this check box to view data points related to the recorded session.

- **Log popup windows:** Logs popup windows that might appear when users open or close a confidential file or access a folder.
- **Log printing activities:** Logs printing activities that occur during recorded sessions. This feature is in preview. It is available with Session Recording version 2407 and later.

b) Select and edit the rule criteria.

Similar to creating a custom recording policy, you can choose one or more rule criteria:

- **Users or Groups**
- **Published Applications or Desktop**
- **Delivery Groups or Machines**
- **IP Address or IP Range**
- **Filter**

To obtain the lists of published applications or desktops and delivery groups or VDA machines, you must have the read permission as a site administrator. Configure the administrator read permission on the Delivery Controller of the site.

For more information, see the instructions in the [Create a custom recording policy](#) section.

Note:

Some sessions might not meet any rule criteria in an event detection policy. For these sessions, the action of the fallback rule applies, which is always **Do not detect**. You cannot modify or delete the fallback rule.

c) Follow the wizard to complete the configuration.

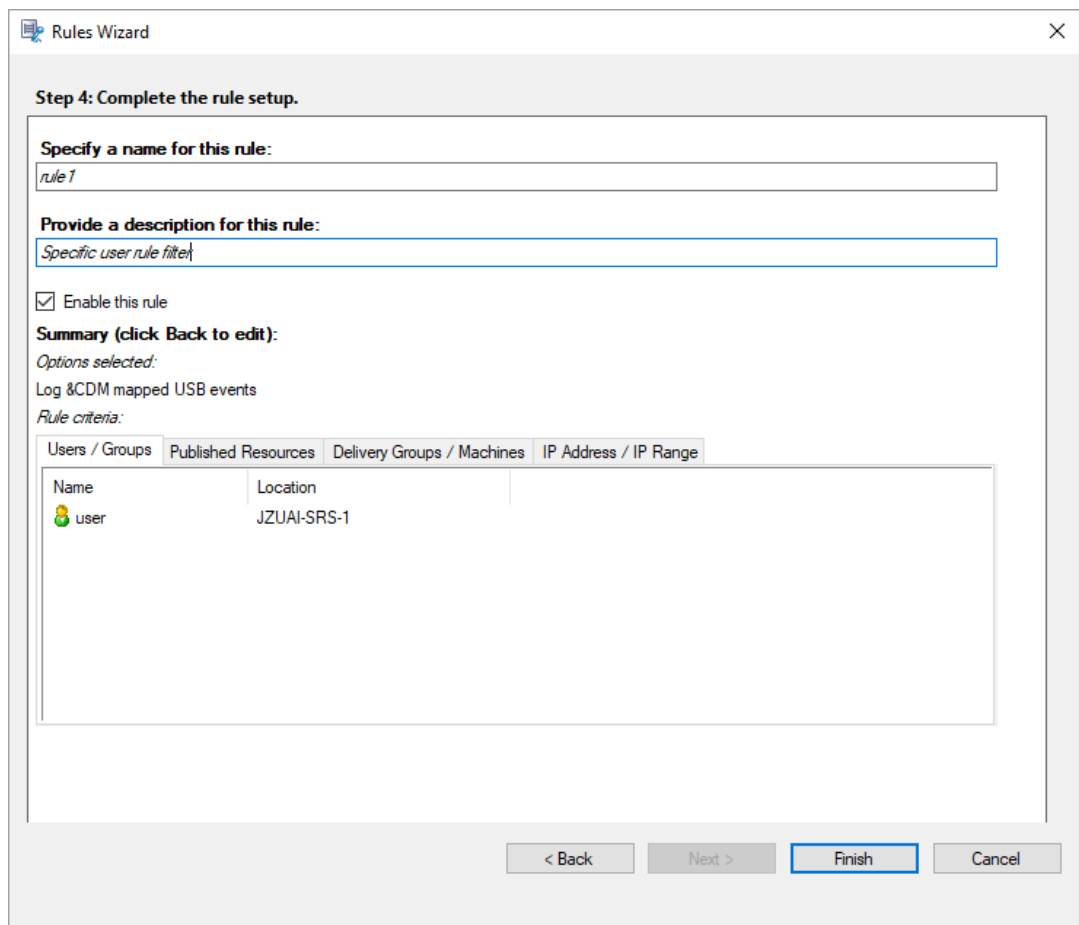

After a session that matches an event detection policy starts, the session ID and its event registry values appear in the Session Recording agent. For example:

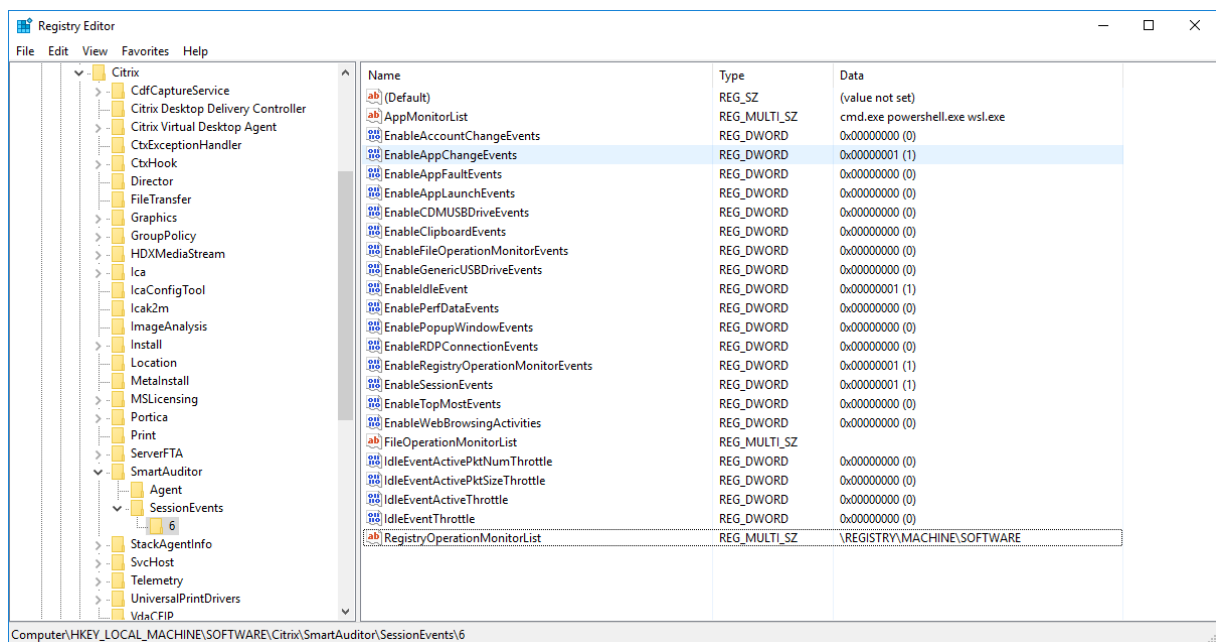

Compatibility with registry configurations

When Session Recording is newly installed or upgraded, no active event detection policy is available by default. In this case, each Session Recording agent respects the registry values under `HKEY_LOCAL_MACHINE\SOFTWARE\Citrix\SmartAuditor\SessionEvents` to determine whether to log specific events. For a description of the registry values, see the following table:

Registry Value	Description
EnableSessionEvents	1 : enables event detection globally; 0 : disables event detection globally (default value data).
EnableAccountChangeEvents	1 : enables detecting user account modifications; 0 : disables detecting user account modifications (default value data).
EnableAppChangeEvents	1 : enables detecting app installs and uninstalls; 0 : disables detecting app installs and uninstalls (default value data).
EnableAppFaultEvents	1 : enables detecting app failures; 0 : disables detecting app failures (default value data).
EnableAppLaunchEvents	1 : enables detecting only app starts; 2 : enables detecting both app starts and ends; 0 : disables detecting app starts and ends (default value data).
AppMonitorList	Specifies target apps to monitor. No app is specified by default, which means no app is captured by default.

Registry Value	Description
EnableCDMUSBDriveEvents	1 : enables detecting the insertion of CDM mapped USB mass storage devices; 0 : disables detecting the insertion of CDM mapped USB mass storage devices (default value data).
EnableClipboardEvents	1 : enables detecting clipboard activities; 0 : disables detecting clipboard activities (default value data).
EnableFileOperationMonitorEvents	1 : enables detecting file operations; 0 : disables detecting file operations (default value data).
FileOperationMonitorList	Specifies target folders to monitor. No folder is specified by default, which means no file operation is captured by default.
EnableGenericUSBDriveEvents	1 : enables detecting the insertion of generic redirected USB mass storage devices; 0 : disables detecting the insertion of generic redirected USB mass storage devices (default value data).
EnablePerfDataEvents	1 : enables the session data overlay feature; 0 : disables the session data overlay feature (default value data).
EnablePopupWindowEvents	1 : enables detecting popup window events; 0 : disables detecting popup window events (default value data).

Registry Value	Description
EnableRDPConnectionEvents	1 : enables detecting RDP connections; 0 : disables detecting RDP connections (default value data).
EnableRegistryOperationMonitorEvents	1 : enables detecting Windows registry modifications; 0 : disables detecting Windows registry modifications (default value data).
RegistryOperationMonitorList	Specifies target registries to monitor. No registry is specified by default, which means no registry modification is captured by default.
EnableWebBrowsingActivities	1 : enables detecting web browsing activities; 0 : disables detecting web browsing activities (default value data).
EnablePrintingEvents	1 : enables detecting printing activities; 0 : disables detecting printing activities (default value data).

Here are some compatible scenarios:

- If your Session Recording is newly installed or upgraded from a release earlier than 1811 that doesn't support event detection (logging), the related registry values on each Session Recording agent are the default. Because there is no active event detection policy by default, no events are logged.
- If your Session Recording is upgraded from a release earlier than 1811 that supports event detection but has the feature disabled before your upgrade, the related registry values on each Session Recording agent remain the default. Because there is no active event detection policy by default, no events are logged.
- If your Session Recording is upgraded from a release earlier than 1811 that supports event detection and has the feature partially or fully enabled before your upgrade, the related registry

values on each Session Recording agent remain the same. Because there is no active event detection policy by default, the event detection behavior remains the same.

- If your Session Recording is upgraded from 1811, the event detection (logging) policies configured in the policy console remain in use.

Caution:

Activating the system-defined or a custom event detection policy means to ignore the relevant registry settings on each Session Recording agent. If you do so, you can't use registry settings for event detection any more.

Configure event response policies

December 3, 2024

You can send an email alert when a session start is detected and take the following actions in response to logged events in recorded sessions:

- Send email alerts
- Start screen recording immediately (with or without lossy screen recording enabled)
- Lock session
- Log off session
- Disconnect session

Note:

If the **Lock session** action doesn't work as expected, check the following registry keys on the VDA and ensure that there is no registry value under them or the value data is set to 0.

- HKEY_LOCAL_MACHINE\SOFTWARE\Microsoft\Windows\CurrentVersion\Policies\System
- HKEY_CURRENT_USER\Software\Microsoft\Windows\CurrentVersion\Policies\System

The only system-defined event response policy is **Do not respond**. You can create custom event response policies as needed. Only one event response policy can be active at a time.

For an example email alert, see the following screen capture:

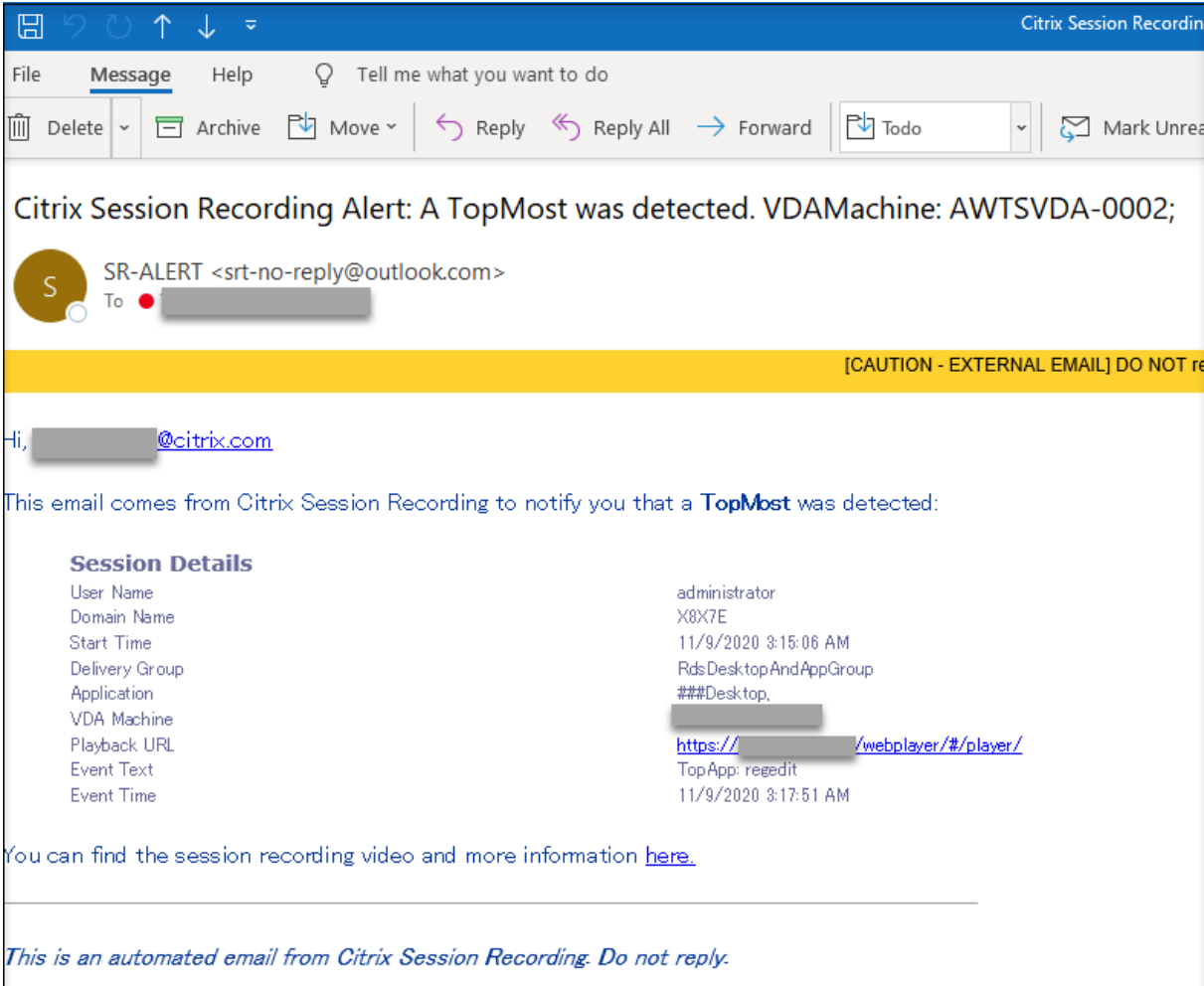

Citrix Session Recording Alert: A TopMost was detected. VDAMachine: AWTSVDA-0002;

SR-ALERT <srt-no-reply@outlook.com>
To: [redacted]

[CAUTION - EXTERNAL EMAIL] DO NOT REPLY

Hi, [redacted]@citrix.com

This email comes from Citrix Session Recording to notify you that a **TopMost** was detected:

Session Details	
User Name	administrator
Domain Name	X8X7E
Start Time	11/9/2020 3:15:06 AM
Delivery Group	RdsDesktopAndAppGroup
Application	###Desktop
VDA Machine	[redacted]
Playback URL	https://[redacted]/webplayer/#/player/
Event Text	TopApp: regedit
Event Time	11/9/2020 3:17:51 AM

You can find the session recording video and more information [here](#).

This is an automated email from Citrix Session Recording. Do not reply.

Tip:

Clicking the playback URL opens the playback page of the recorded session in the web player.
Clicking **here** opens the **All recordings** page in the web player.

Session Recording sends email alerts in the operating system language of your Session Recording server. However, if the operating system language of your Session Recording server is not one of the following languages that Session Recording supports, email alerts are sent in English by default:

- English
- French
- German
- Spanish
- Japanese
- Simplified Chinese

To customize a language to send email alerts in, find the email template called `template.en.html` under `<Session Recording server installation path>\Bin\templates`, and then

change the plain text in the template to your preferred language. For example:

```

1 <!DOCTYPE html>
2 <html lang="en" xmlns="http://www.w3.org/TR/REC-html40" xmlns:m="http://schemas.microsoft.com/office/2004/12/omml" xmlns:w="urn:schemas-microsoft-com:off
3
4   <meta http-equiv="Content-Type" content="text/html; charset=utf-8">
5 </head>
6 <body lang="EN-US" link="blue" vlink="purple">
7   <div class="WordSection1">
8     <p>
9       <span style="color:#003399">
10        Hi $SINGLE_RECEIVERS
11      </span>
12    </p>
13    <p>
14      <span style="color:#003399">
15        This email comes from Citrix Session Recording to notify you that a <strong>SALERT_REASONS</strong> was detected.
16      </span>
17    </p>
18    <table width="0" class="MsoNormalTable" style="width:12.0in;margin-left:33.75pt;background:white;border-collapse:collapse" border="0" cellspac
19    <tbody>
20      <tr>
21        <td style="padding:0in 0in 0in 0in">
22          <p>
23            <strong><span style="font-size:10.5pt;font-family:"Verdana",sans-serif;color:#666699"> Session Details</span></strong>
24          </p>
25        </td>
26      </tr>
27    </tbody>
28    <!--_SDATA_SEGMENT-->
29  </table>
30  <p>
31    <span style="color:#003399">
32      You can find the session recording video and more information <a href="$DISPLAY_LINKS">here.</a>
33    </span>
34  </p>
35 </div>

```

System-defined event response policy

Session Recording provides one system-defined event response policy:

- **Do not respond.** By default, no action is taken in response to logged events in your recordings.

Create a custom event response policy

1. Log on as an authorized policy administrator to the server where the Session Recording policy console is installed.
2. Start the Session Recording policy console. By default, there is no active event response policy.

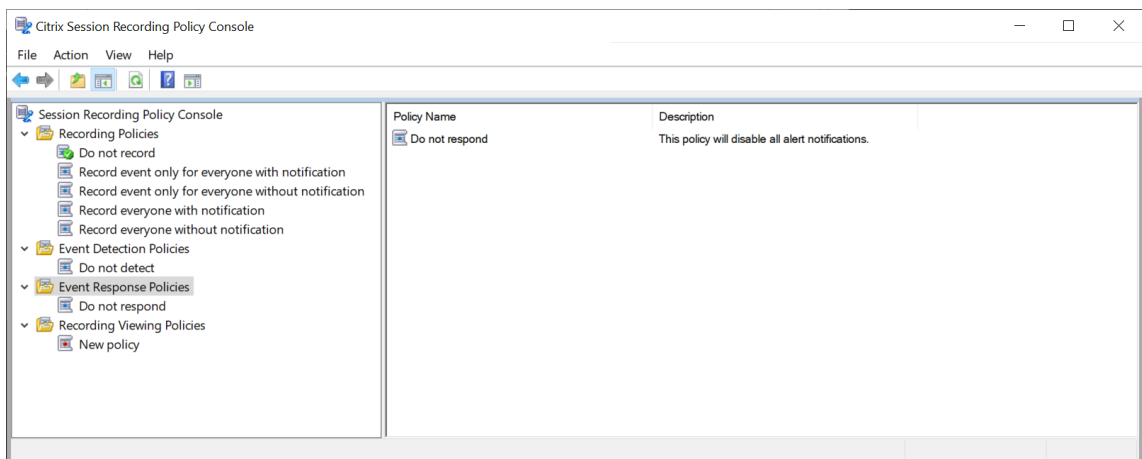

3. Select **Event Response Policies** in the left pane. From the menu bar, choose **Add New Policy**.
4. (Optional) Right-click the new event response policy and rename it.
5. Right-click the new event response policy and select **Add Rule**.
6. Select **Email alert when a session start is detected** and **Use event triggers to specify how to respond when a session event is detected** based on your needs.

The screenshot shows the 'Rules Wizard' dialog box with the following content:

Step 1-1: Select one or more of the following options.

- Email alert when a session start is detected.
- Trigger response actions when a session event is detected

Configure event triggers and responses

Step 1-2: Enter email addresses for the alert recipients.

Email recipients:
Type the email addresses who will receive alerts according to this rule. Separate the addresses with a semicolon (;).

Step 1-3: Set parameters for dynamic screen recording.

Screen recording time span after we detect an event:
How many minutes do you want us to record the screen after we detect an event?

Screen recording time span before we detect an event:
How many seconds of the screen recording do you want us to keep before we detect an event?

Time interval between a session operation notice and its execution (available for session lock, log off, and disconnection)
How many seconds do you want us to hold a session operation after we issue the notice?

Enable lossy screen recording

At the bottom, there are three buttons: '< Back', 'Next >', and 'Cancel'.

7. (Optional) Set email recipients and the email sender properties.
 - a) Type the email addresses for the alert recipients in the **Rules** wizard.
 - b) Configure outgoing email settings in the **Session Recording Server Properties**.

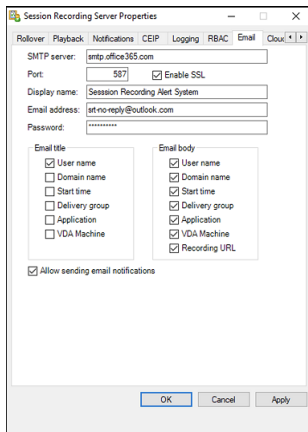

Note:

If you select more than two options in the **Email title** section, a warning dialog appears, saying that the email subject might be too long. After you select **Allow sending email notifications** and click **Apply**, Session Recording sends an email to verify your email settings. If any setting is incorrect, for example, an incorrect password or port, Session Recording returns an error message with the error details.

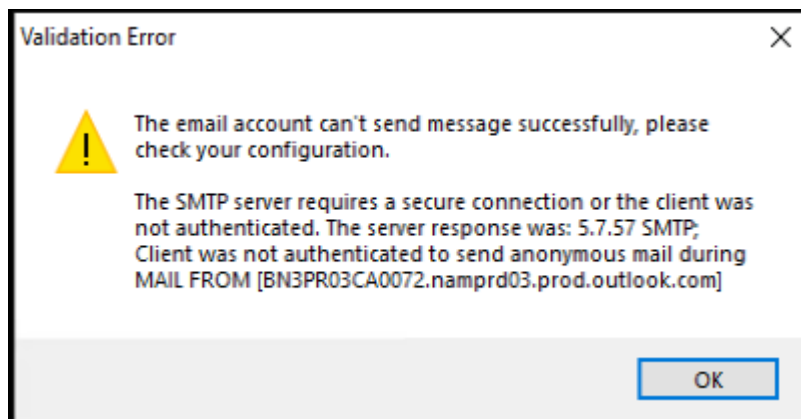

Your email settings need about five minutes to take effect. To have your email settings take effect immediately or fix the issue that emails are not sent according to the settings, restart the Storage Manager (`CitrixSsRecStorageManager`) service. Also, restart the Storage Manager service if you upgrade to the current release from Version 2006 and earlier.

- c) Edit the registry for accessing the web player.

To make the playback URLs in your alert emails work as expected, browse to the registry key at `HKEY_LOCAL_MACHINE\SOFTWARE\Citrix\SmartAuditor\Server` and do the following:

- Set the value data of **LinkHost** to the URL of the domain that you use to access the web player. For example, to access a web player at <https://example.com/>

webplayer/#/player/, set the value data of **LinkHost** to <https://example.com>.

- Add a value **EmailThreshold**, and set its value data to a number in the range of 1 through 100. The value data determines the maximum number of alert emails that an email sending account sends within a second. This setting helps slow down the number of emails that are being sent and thus reduces the CPU usage. If you leave the value data unspecified or set it to a number out of range, the value data falls back to 25.

Note:

- Your email server might treat an email sending account as a spam bot and thus prevent it from sending emails. Before an account is allowed to send emails, an email client such as Outlook might request you to verify that the account is used by a human user.
- There is a limit for sending emails within a given period. For example, when the daily limit is reached, you cannot send emails until the start of the next day. In this case, ensure that the limit is more than the number of sessions being recorded within the period.

8. (Optional) Configure event triggers and responses.

After you select **Trigger response actions when a session event is detected**, the **Configure event triggers and responses** button becomes available. Click it to specify logged events that can trigger the following response actions:

- Send email alerts
- Start screen recording immediately
- Lock session
- Log off session
- Disconnect session

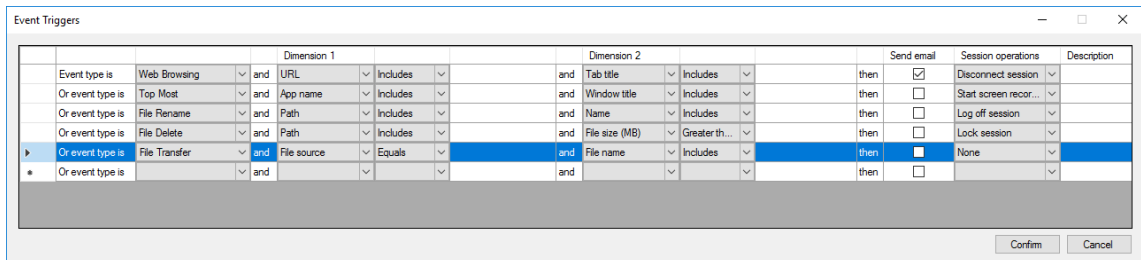

Note:

If your system language is German, French, or Spanish, ensure that the horizontal resolution of your machine is equal to or larger than 1,700 pixels. Otherwise, text truncation

occurs and thus the columns of the **Event Triggers** table are not displayed completely.

You must select the event types that the active event detection policy logs. Click **Confirm** when you are finished.

Select event types from the drop-down list and set event rules through the two dimensions that are combined using the logical AND operator. You can set up to seven event triggers for each policy rule. You can also define your event triggers in the **Description** column or leave the column empty. Your defined description of an event trigger is provided in the alert emails if you have **Send email** selected and events of the type are logged. If you have **Start screen recording** selected, dynamic screen recording automatically starts when certain events occur during an event-only recording. You can enable lossy screen recording and set the time spans for dynamic screen recording:

The screenshot shows the 'Rules Wizard' dialog box, specifically Step 1-3: Set parameters for dynamic screen recording. The dialog is divided into three steps:

- Step 1-1: Select one or more of the following options.**
 - Email alert when a session start is detected.
 - Trigger response actions when a session event is detected

Below these options is a button labeled 'Configure event triggers and responses'.
- Step 1-2: Enter email addresses for the alert recipients.**

Email recipients:

Type the email addresses who will receive alerts according to this rule. Separate the addresses with a semicolon (;).
- Step 1-3: Set parameters for dynamic screen recording.**
 - Screen recording time span after we detect an event:

How many minutes do you want us to record the screen after we detect an event?
 - Screen recording time span before we detect an event:

How many seconds of the screen recording do you want us to keep before we detect an event?
 - Time interval between a session operation notice and its execution (available for session lock, log off, and disconnection)

How many seconds do you want us to hold a session operation after we issue the notice?
 - Enable lossy screen recording

At the bottom of the dialog are three buttons: '< Back', 'Next >', and 'Cancel'.

- **Screen recording time span after we detect an event:** You can configure how many minutes you want to record the screen after events are detected. If you leave the value unspecified, screen recording continues until the recorded sessions end.
- **Screen recording time span before we detect an event:** You can configure how many

seconds of the screen recording you want to keep before events are detected. This feature is available for both virtual desktop and app sessions. The value ranges from 1 to 120. Setting the value to any of 1 through 10 makes the value 10 effective. If you leave the value unspecified, the feature does not take effect. The actual length of the screen recording that Session Recording keeps might be a little longer than your configuration.

- If you specify any of the following actions in response to logged events in recorded sessions, you can notify users of the actions by filling the **Time interval between a session operation notice and its execution** field:
 - Lock session
 - Log off session
 - Disconnect session

Note:

The field value is 0 by default, which means users are not notified when you lock, log off, or disconnect them from their virtual sessions. To notify users, set an appropriate field value.

For an example notice, see the following screen capture:

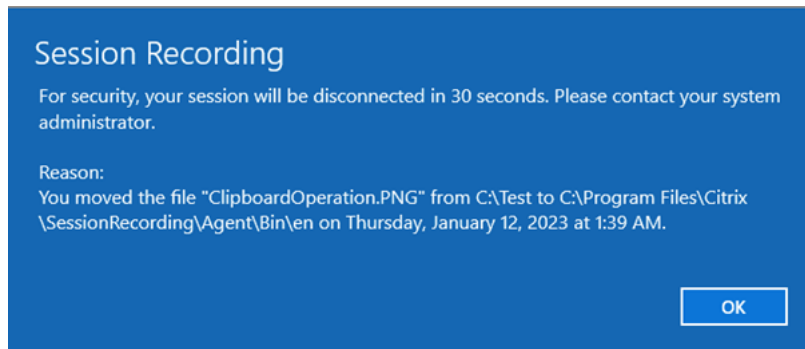

- **Enable Lossy screen recording:** Lossy screen recording lets you adjust compression options to reduce the size of recording files and to accelerate navigating recorded sessions during playback. For more information, see [Enable or disable lossy screen recording](#).

For a complete list of supported event types, see the following table.

Event type	Dimension	Option
App Start	App name	Includes, Equals, Matches
	Full command line	Includes, Equals, Matches
App End		

Event type	Dimension	Option
Top Most	App name	Includes, Equals, Matches
	Windows title	Includes, Equals, Matches
Web Browsing	URL	Includes, Equals, Matches
	Tab title	Includes, Equals, Matches
	Browser name	Includes, Equals, Matches
File Create	Path	Includes, Equals, Matches
	File size (MB)	Greater than, Between, Smaller than
File Rename	Path	Includes, Equals, Matches
	Name	Includes, Equals, Matches
File Move	Source path	Includes, Equals, Matches
	Destination path	Includes, Equals, Matches
	File size (MB)	Greater than, Between, Smaller than
File Delete	Path	Includes, Equals, Matches
	File size (MB)	Greater than, Between, Smaller than
CDM USB	Drive letter	Equals
Generic USB	Device name	Includes, Equals, Matches
Idle	idle duration (Hrs)	Greater than

Event type	Dimension	Option
File Transfer	File source	Equals (“host” or “client”)
	File size (MB)	Greater than
	File name	Includes, Equals, Matches
Registry Create	Key name	Includes, Equals, Matches
Registry Delete	Key name	Includes, Equals, Matches
Registry Set Value	Key name	Includes, Equals, Matches
	Value name	Includes, Equals, Matches
Registry Delete Value	Key name	Includes, Equals, Matches
	Value name	Includes, Equals, Matches
Registry Rename	Key name	Includes, Equals, Matches
User Account Modification	User name	Includes, Equals, Matches
Unexpected App Exit	App name	Includes, Equals, Matches
App Not Responding	App name	Includes, Equals, Matches
New App Installed	App name	Includes, Equals, Matches
App Uninstalled	App name	Includes, Equals, Matches
RDP Connection	IP address	Includes, Equals, Matches
Popup Window		

Event type	Dimension	Option
	Process name	Includes, Matches
	Window content	Includes, Equals, Matches
Performance Data	CPU usage (%)	Greater than
	Memory usage (%)	Greater than
	Net send (MB)	Greater than
	Net receive (MB)	Greater than
	RTT (ms)	Greater than
Clipboard Operation	Data type	Equals (Text, File, Bitmap)
	Process name	Includes, Equals, Matches
	Content	Includes, Equals, Matches

9. Click **Next** to select and edit the rule criteria.

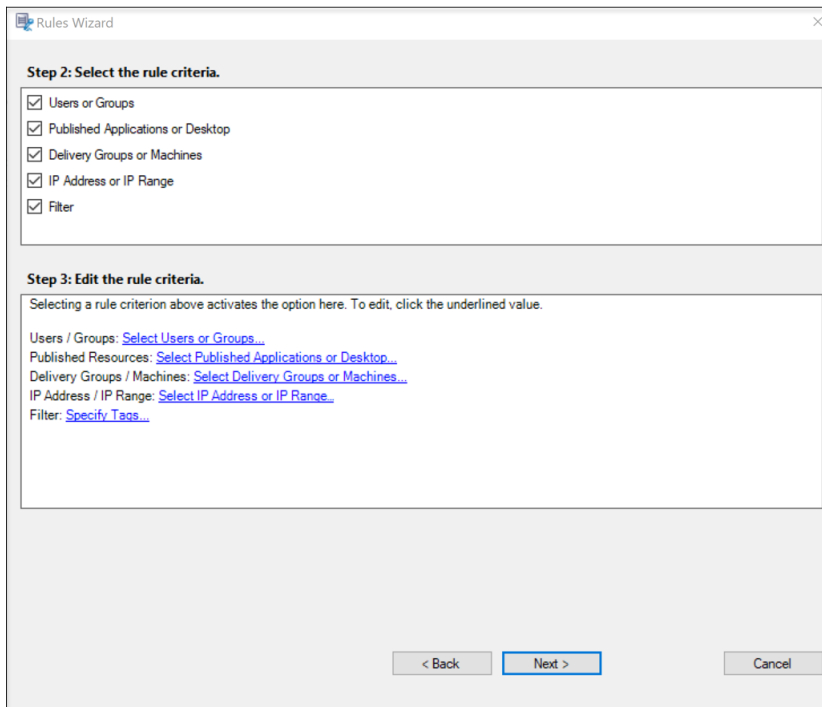

- **Users or Groups.** Creates a list of users or groups to which the rule applies.
- **Published Applications or Desktop.** Creates a list of published applications or desktops

to which the rule applies.

- **Delivery Groups or Machines.** Creates a list of Delivery Groups or machines to which the rule applies.
- **IP Address or IP Range.** Creates a list of IP addresses or ranges of IP addresses to which the rule applies. The IP addresses mentioned here are the IP addresses of the Citrix Workspace apps.
- **Filter.** Creates a list of smart access tags to which the rule applies. You can configure contextual access (smart access) using smart access policies on Citrix NetScaler.

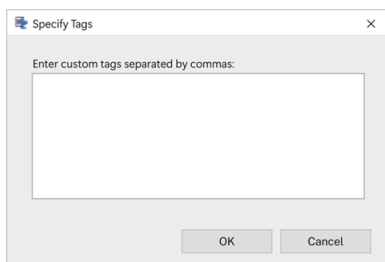

Contextual access (smart access) is available for Session Recording 2402 and later. It lets you apply policies based on the user access context including:

- The user's location
- IP address range
- Delivery group
- Device type
- Installed applications

Note:

When a session or an event meets more than one rule in a single event response policy, the oldest rule takes effect.

10. Follow the wizard to complete the configuration.
11. Activate the new event response policy.

High availability and load balancing

December 3, 2024

This section guides you through the following settings:

- [Load balance Session Recording servers](#)
- [Configure database high availability](#)

Load balance Session Recording servers

December 3, 2024

Session Recording supports **load balancing** across Session Recording servers. This article summarizes the **load balancing** configuration using the Citrix ADC as an example. For more information, see [Configure load balancing in an existing deployment](#) and [Deploy and load balance Session Recording in Azure](#).

You can synchronize **load balancing** configurations among all Session Recording servers.

Note:

The **load balancing** feature requires Version 7.16 or later of the Session Recording server and Session Recording agent.

Changes to Session Recording in support of load balancing:

- All Session Recording servers share one folder to store recording files.
- All Session Recording servers share one Session Recording Database.
- (Recommended) Install only one Session Recording policy console and all Session Recording servers share this console.

Configure load balancing

To use this feature, perform the following steps on Citrix ADC and on the various Session Recording components:

Configure load balancing (Citrix ADC part)

Configure load balancing servers Add the Session Recording servers to the **load balancing servers** in Citrix ADC.

Configure load balancing services

1. Add a **load balancing service** for each needed protocol on each Session Recording server.
2. (Recommended) Select the relevant protocol monitor to bind each service monitor.

Configure load balancing virtual servers

1. Create virtual servers with the same Citrix ADC VIP address based on the needed protocols and bind the virtual servers to the relevant **load balancing services**.

2. Configure persistence on each virtual server.
3. (Recommended) Choose LEASTBANDWIDTH or LEASTPACKETS as the **load balancing method** rather than the default method (LEASTCONNECTION).
4. Create a certificate to make the HTTPS virtual server UP.

Configure load balancing (Session Recording part)

On each server where you installed the Session Recording server, do the following

1. (Recommended) Type the same Session Recording Database name during the Session Recording server installation.
2. If you choose the Administrator Logging feature, we recommend you type the same Administrator Logging Database name when you install each Session Recording server.
3. Share the Read/Write permission of the file storage folder with all Session Recording server machine accounts. After that, change to use the file storage folder as the shared folder in **Session Recording Server Properties**. For more information, see [Specify where recordings are restored](#).
4. Add a value to the Session Recording server registry key at `HKEY_LOCAL_MACHINE\SOFTWARE\Citrix\SmartAuditor\Server`.
Value name: **EnableLB**
Value data: **1** (DWORD, meaning enable)
5. If you choose the HTTP or the HTTPS protocol for the Session Recording Storage Manager message queue, create a host record for the Citrix ADC VIP address and add redirections in `C:\Windows\System32\msmq\Mapping\sample_map`. After that, restart the Message Queuing service.

The redirection is similar to:

```
1 <redirections xmlns="msmq-queue-redirections.xml">
2     <redirection>
3         <from>http://<ADCHost>*/msmq/private$/
4             CitrixSmAudData</from>
5         <to>http://<LocalFqdn>/msmq/private$/
6             CitrixSmAudData</to>
7     </redirection>
8     <redirection>
9         <from>https://<ADCHost>*/msmq/private$/
10            CitrixSmAudData</from>
11        <to>https://<LocalFqdn>/msmq/private$/
12            CitrixSmAudData</to>
13    </redirection>
14 </redirections>
```

Where **<ADCHost>** is the created FQDN of the Citrix ADC VIP address, and **<LocalFqdn>** is the FQDN of the local host.

6. (Recommended) After configuring one Session Recording server registry, you can use the **<Session Recording Server installation path>\Scripts\SrServerConfigurationSync.ps1** script to export configurations from this server registry and import the registry to the other Session Recording server registries. You can also use the **SrServerConfigurationSync.ps1** script to add redirection mapping for message queuing.
 - a) On one Session Recording server, after configuring the **EnableLB** registry value, start a command prompt as an administrator and run the **powershell.exe -file SrServerConfigurationSync.ps1 -Action Export,AddRedirection -ADCHost <ADCHost>** command, where **<ADCHost>** is the created FQDN of the Citrix ADC VIP address.
 - b) After the script runs, an exported registry file named **SrServerConfig.reg** is generated and an **sr_lb_map.xml** file is added to the **C:\Windows\System32\msmq\Mapping** path.
 - c) On other Session Recording servers, copy **SrServerConfig.reg** generated in the preceding step, start a command prompt as an administrator, and run the **powershell.exe -file SrServerConfigurationSync.ps1 -Action Import,AddRedirection -ADCHost <ADCHost>** command, where **<ADCHost>** is the created FQDN of the Citrix ADC VIP address.
 - d) After the script runs, the **EnableLB** value is added to the other Session Recording server registry keys and an **sr_lb_map.xml** file is added to the **C:\Windows\System32\msmq\Mapping** path.

On the machine where you installed the Session Recording agent, do the following in Session Recording Agent Properties

- If you choose the HTTP or the HTTPS protocol for the Session Recording Storage Manager message queue, type the FQDN of the Citrix ADC VIP address in the **Session Recording Server** text box.
- If you choose the default TCP protocol for the Session Recording Storage Manager message queue, type the Citrix ADC VIP address in the **Session Recording Server** text box.

On the machine where you installed the Session Recording Player, do the following Add the Citrix ADC VIP address or its FQDN as the connected Session Recording server.

On the SQL Server where you installed the Session Recording Database, do the following Add all the Session Recording server machine accounts to the shared Session Recording Database and assign them with the **db_owner** permission.

Configure database high availability

December 3, 2024

Session Recording does not function as expected if the Session Recording database is stopped or in a state of failure. If the Session Recording Administrator Logging database is stopped or experiencing failure, the administrator logging feature becomes unavailable and this prevents you from being able to modify policies or change server properties when mandatory blocking is enabled. Therefore, it is advisable to implement a high availability (HA) mode for the databases.

Session Recording supports the following solutions for database high availability based on the Microsoft SQL Server. Databases can automatically fail over when the hardware or software of a principal or primary SQL Server fails.

- Always On availability groups

The Always On availability groups feature is a high availability and disaster-recovery solution that provides an enterprise-level alternative to database mirroring. It maximizes the availability of a set of user databases for an enterprise. It requires that the SQL Server instances reside on the Windows Server Failover Clustering (WSFC) nodes. For more information, see [Always On availability groups: a high-availability and disaster-recovery solution](#).

- SQL Server clustering

The Microsoft SQL clustering technology allows one server to automatically take over the tasks and responsibilities of the server that has failed. However, setting up this solution is complicated and the automatic failover is typically slower than alternatives such as SQL Server database mirroring. For more information, see [Always On Failover Cluster Instances \(SQL Server\)](#).

- SQL Server database mirroring

Database mirroring ensures that an automatic failover occurs in seconds if the active database server fails. This solution is more expensive than the other two solutions because full SQL Server licenses are required on each database server. You cannot use the SQL Server Express edition in a mirrored environment. For more information, see [Database Mirroring \(SQL Server\)](#).

Methods for configuring Session Recording with database high availability

To configure Session Recording with database high availability, do either of the following:

- Install the Session Recording Server components first and then configure database high availability for the created databases.

You can install the Session Recording Administration components with databases configured to

be installed on the prepared SQL Server instance. Then, configure database high availability for the created databases.

- For Always On availability groups and clustering, change the SQL Server instance name to the name of the availability group listener or SQL Server network through `HKEY_LOCAL_MACHINE\SOFTWARE\Citrix\SmartAuditor\Server\SmAudDatabaseIn`.
 - For database mirroring, add the failover partners for databases through `HKEY_LOCAL_MACHINE\SOFTWARE\Citrix\SmartAuditor\Server\DatabaseFailoverPartner` and `HKEY_LOCAL_MACHINE\SOFTWARE\Citrix\SmartAuditor\Server\LoggingDatabaseFailoverPartner`.
- Configure database high availability for empty databases first and then install the Session Recording Administration components.
You can create two empty databases as the Session Recording Database and the Administrator Logging Database in the expected primary SQL Server instance and configure high availability. Then enter the SQL Server instance name when installing the Session Recording Server components:
 - To use the Always On availability groups solution, enter the name of your availability group listener.
 - To use the database mirroring solution, enter the name of your principal SQL Server.
 - To use the clustering solution, enter the network name of your SQL Server.

View recordings

December 3, 2024

Use the Session Recording player or the Session Recording web player to view, search, and bookmark recorded sessions.

If sessions are recorded with the live playback feature enabled, you can view sessions that are in progress, with a delay of 1-2 seconds.

Sessions that have a longer duration or larger file size than the limits configured appear in more than one session file.

Note:

Grant users the right to access the recorded sessions of VDAs.

Session Recording player

December 3, 2024

The Session Recording player is a user interface that you access from a workstation to play recorded session files. This section provides instructions for you to:

- [Launch the Session Recording player](#)
- [Enable or disable live session playback](#)
- [Enable or disable playback protection](#)
- [Search for recordings](#)
- [Open and play recordings](#)
- [Cache recordings](#)
- [Highlight idle periods](#)
- [Use events and bookmarks](#)

Launch the Session Recording Player

December 3, 2024

Launch the Session Recording player

Note:

- If a recording contains blocked content, Session Recording skips it. However, if you navigate to the blocked period, your playback shows a black screen and a message indicating that that content is blocked. To use this feature, use Session Recording 2012 and later.
- If you are using the Session Recording player 2009 and earlier to play back a recording, the following error message appears. The web player is not impacted.

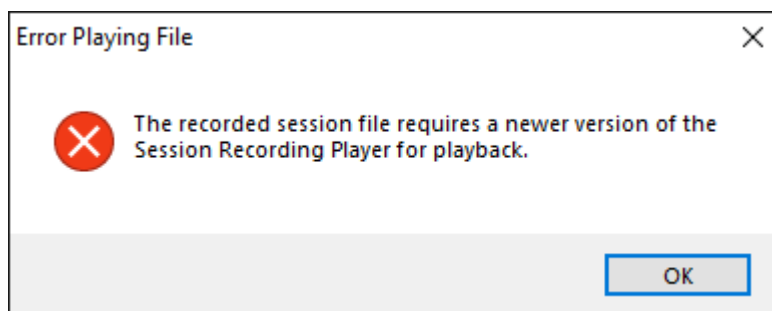

- If playback justification logging is enabled, each time you play a recording, a dialog box appears, asking you to enter a playback justification. For more information, see [Playback logging](#).

1. Log on to the workstation where the Session Recording Player is installed.
2. From the **Start** menu, choose **Session Recording Player**. The Session Recording player appears.

Tip:

- To customize columns to display, right-click the table header.

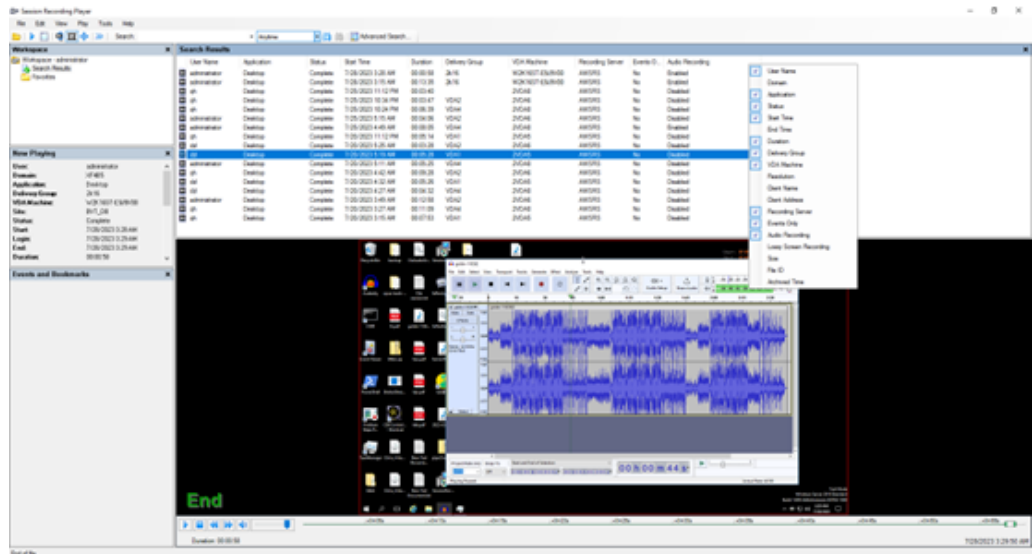

- The **Audio Recording** column indicates whether audio in the recorded session is available during playback.
- The **EventOnly** column indicates a screen recording or an event-only recording.

The following screen capture shows an example of an event-only recording being played in the Session Recording Player. All events are present in the **Events and Bookmarks** panel and show as yellow dots in the lower part of the Session Recording Player.

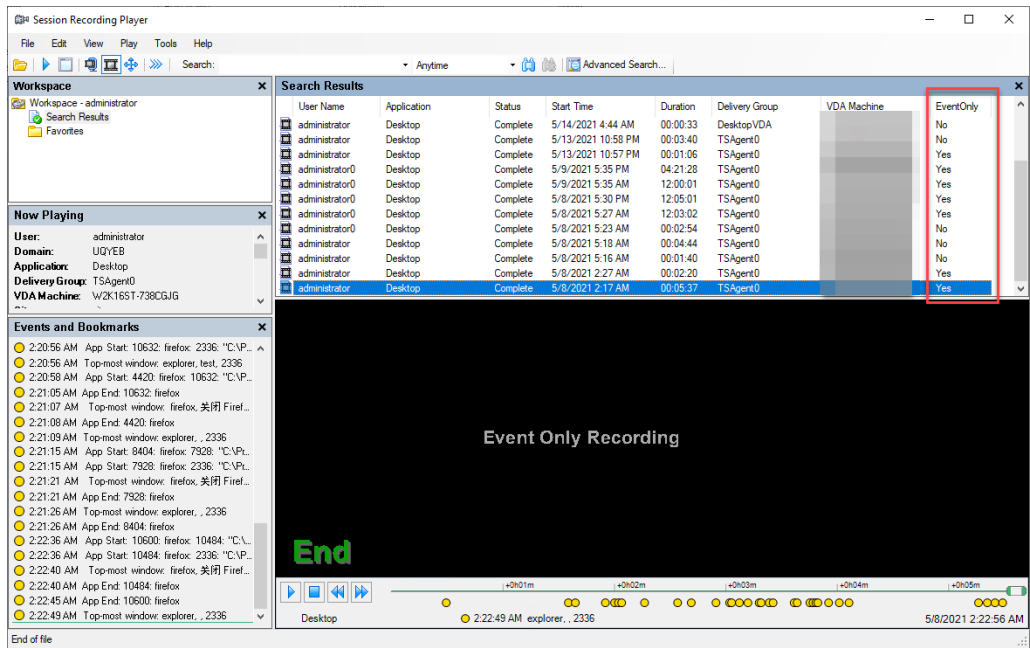

- To show all recording files of a recorded session, right-click a recording on the list and choose **Follow up**.

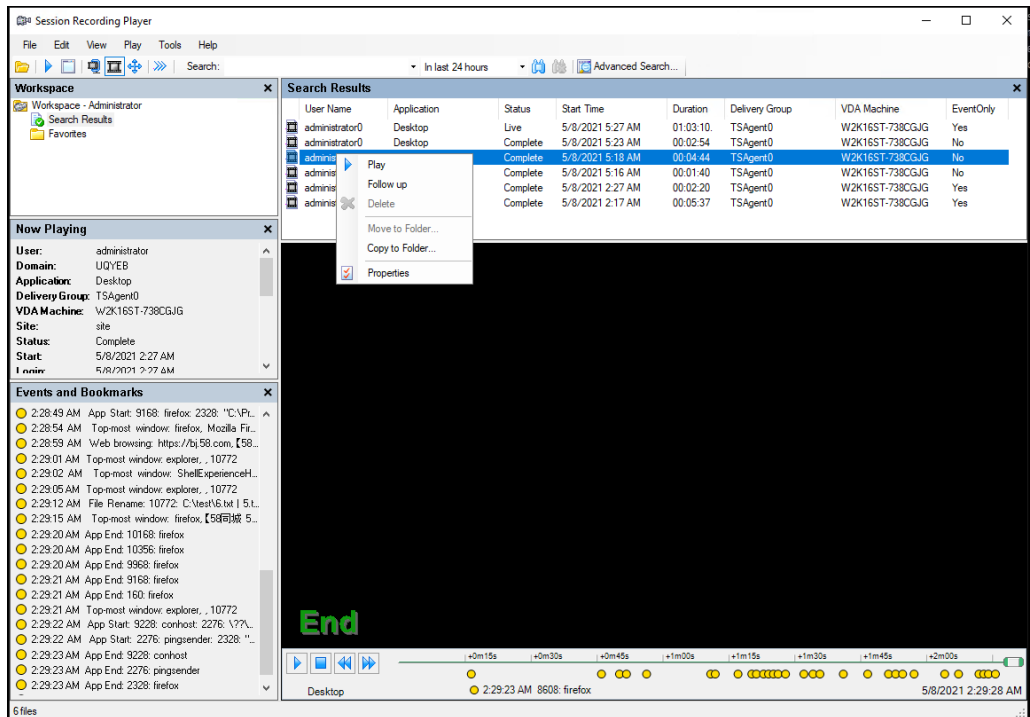

Display or hide window elements

The Session Recording player has window elements that toggle on and off.

1. Log on to the workstation where the Session Recording player is installed.
2. From the **Start** menu, choose **Session Recording Player**.
3. From the **Session Recording Player** menu bar, choose **View**.
4. Choose the elements that you want to display. Selecting an element causes it to appear immediately. A check mark indicates that the element is selected.

Connect to the desired Session Recording Server

You can set up your Session Recording player to connect to multiple Session Recording servers and then select a Session Recording server that it connects to. The Session Recording player can connect to only one Session Recording Server at a time.

1. Log on to the workstation where the Session Recording player is installed.
2. From the **Start** menu, choose **Session Recording Player**.
3. From the **Session Recording Player** menu bar, choose **Tools > Options > Connections**.
4. Select the Session Recording server to which you want to connect.

Enable or disable live session playback

December 3, 2024

If sessions are recorded with the live playback feature enabled, you can view a session after or while it is being recorded. Viewing a session that is being recorded is similar to seeing actions happening live. However, there is actually a delay of 1-2 seconds when the data propagates from the VDA.

Some functionality is not available when you view live playback sessions:

- You can't assign a digital signature or view the certificate until the recording is completed.
- Playback protection can't be applied until recording is complete. If playback protection is enabled, you can view live playback sessions. But they are not encrypted until the session is completed.
- You can't cache a file until the recording is completed.

By default, live session playback is enabled.

1. Log on to the computer hosting the Session Recording server.
2. From the **Start** menu, choose **Session Recording Server Properties**.
3. In **Session Recording Server Properties**, click the **Playback** tab.
4. Select or clear the **Allow live session playback** check box.

Enable or disable playback protection

December 3, 2024

As a security precaution, Session Recording automatically encrypts recorded files that are downloaded for viewing in the player. Encrypted files can't be copied or played on another workstation or by another user. Encrypted files are identified with an `.icle` extension. Unencrypted files are identified with an `.icl` extension. The files remain encrypted while they reside in `%localAppData%\Citrix\SessionRecording\Player\Cache` on the player until an authorized user opens them.

We recommend that you use HTTPS to protect the transfer of data.

By default, playback protection is enabled.

1. Log on to the machine hosting the Session Recording Server.
2. From the **Start** menu, choose **Session Recording Server Properties**.
3. In **Session Recording Server Properties**, click the **Playback** tab.
4. Select or clear the **Encrypt session recording files downloaded for playback** check box.

Search for recordings

December 3, 2024

The Session Recording player allows you to perform quick and advanced searches and to specify options that apply to all searches. Results of searches appear in the search results area of the Session Recording player.

Note:

The player installation typically lets you set up a connection between the Session Recording player and a Session Recording server. If you fail to set up the connection, you are prompted to do so the first time you perform a search for files.

To display all available recorded sessions, up to the maximum number of sessions that might appear in a search, perform a search without specifying any search parameters.

Perform a quick search

1. Log on to the workstation where the Session Recording player is installed.
2. From the **Start** menu, choose **Session Recording Player**.

3. Define your search criteria:
 - Enter a search criterion in the **Search** field.
 - Move the mouse pointer over the **Search** label to display a list of parameters to use as a guideline.
 - Click the arrow to the right of the **Search** field to display the text for the last 64 searches you performed.
 - Use the drop-down list to the right of the **Search** field to select a period or duration specifying when the session was recorded.
4. Click the binocular icon to the right of the drop-down list to start the search.

Perform an advanced search

Advanced searches might take up to 20 seconds to return results containing more than 150,000 entities. Citrix recommends using more accurate search conditions such as a date range or user to reduce the result number.

1. Log on to the workstation where the Session Recording player is installed.
2. From the **Start** menu, choose **Session Recording Player**.
3. In the **Session Recording Player** window, click **Advanced Search** on the tool bar or choose **Tools > Advanced Search**.
4. Define your search criteria on the tabs of the **Advanced Search** dialog box:
 - **Common** allows you to search by domain or account authority, site, group, VDA for multi-session OS, application, or file ID.
 - **Date/Time** allows you to search date, day of week, and time of day.
 - **Events** allows you to search for Citrix-defined and custom events that are inserted to the sessions.
 - **Other** allows you to search by session name, client name, client address, and recording duration. It also allows you to specify, for this search, the maximum number of search results displayed and whether archived files are included in the search.

When you specify search criteria, the query you are creating appears in the pane at the bottom of the dialog box.
5. Click **Search** to start the search.

You can save and retrieve advanced search queries. Click **Save** in the **Advanced Search** dialog box to save the current query. Click **Open** in the **Advanced Search** dialog box to retrieve a saved query. Queries are saved as files with an **.isq** extension.

Set search options

The Session Recording player search options allow you to limit the maximum number of session recordings that appear in search results and to specify whether search results include archived session files.

1. Log on to the workstation where the Session Recording player is installed.
2. From the **Start** menu, choose **Session Recording Player**.
3. From the **Session Recording Player** menu bar, choose **Tools > Options > Search**.
4. In the **Maximum result to display** field, type the number of search results you want to display. A maximum of 500 results can be displayed.
5. To set whether archived files are included in searches, select or clear **Include archived files**.

Place access restrictions on recordings

December 3, 2024

You place access restrictions on target recordings in addition to role-based access control through [recording viewing policies](#). Restricted recordings are accessible only to users and user groups that are assigned the **PrivilegedPlayer** role through the Session Recording Authorization Console.

Note:

Placing access restrictions on live recordings is not supported.

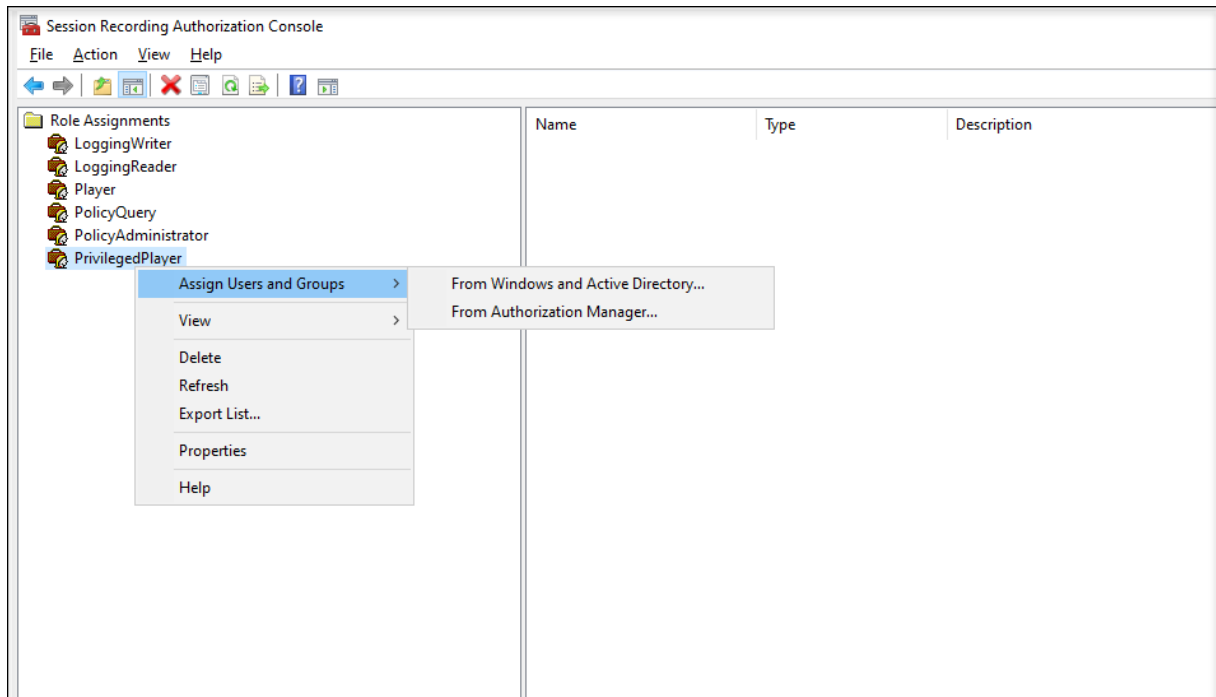

The following section walks you through the process of placing and removing access restrictions on target recordings.

1. Log on to the machine where the Session Recording player is installed.
2. From the **Start** menu, choose **Session Recording Player**.
3. Select **Search Results** in the **Workspace** pane.
4. In the **Search Results** area, select one or more target recordings.
5. Right-click and select **Place access restrictions**.

Users and user groups, assigned either the **Player** or the **PrivilegedPlayer** role, are allowed to place access restrictions on recordings. The **Restricted** menu is available only for users and user groups assigned the **PrivilegedPlayer** role.

View for the **PrivilegedPlayer** role:

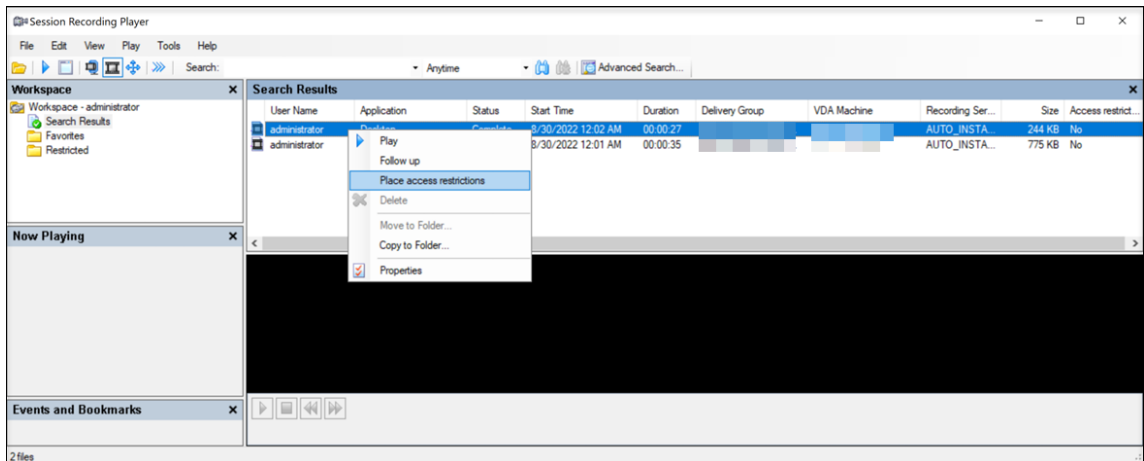

View for the **Player** role:

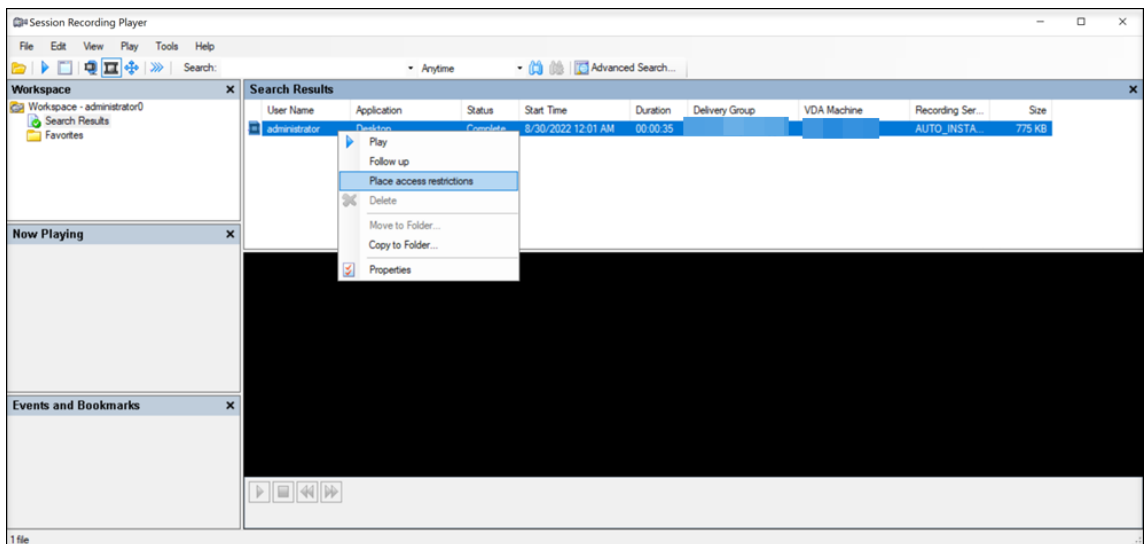

6. Click **Yes**.

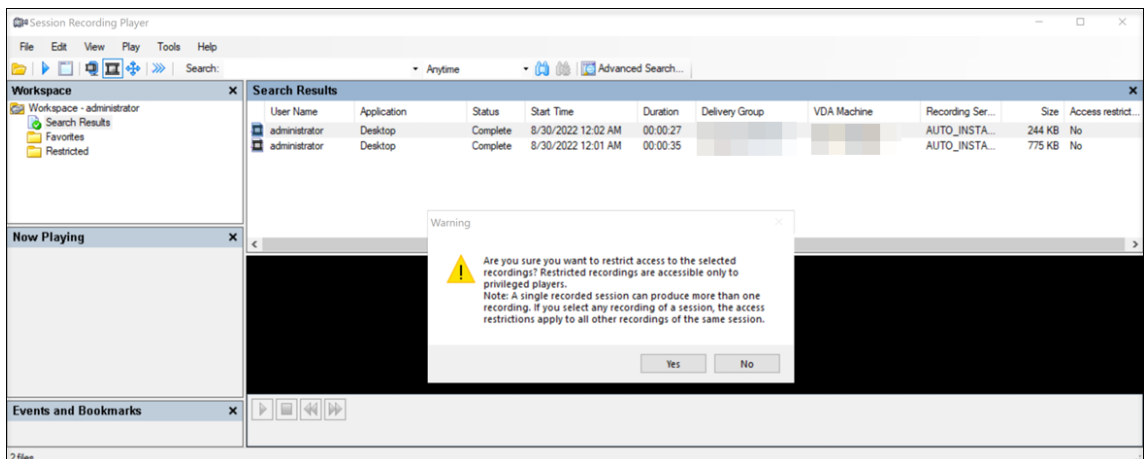

7. Verify that the selected recordings on which you placed access restrictions are moved from the **Search Results** area to the **Restricted** area.

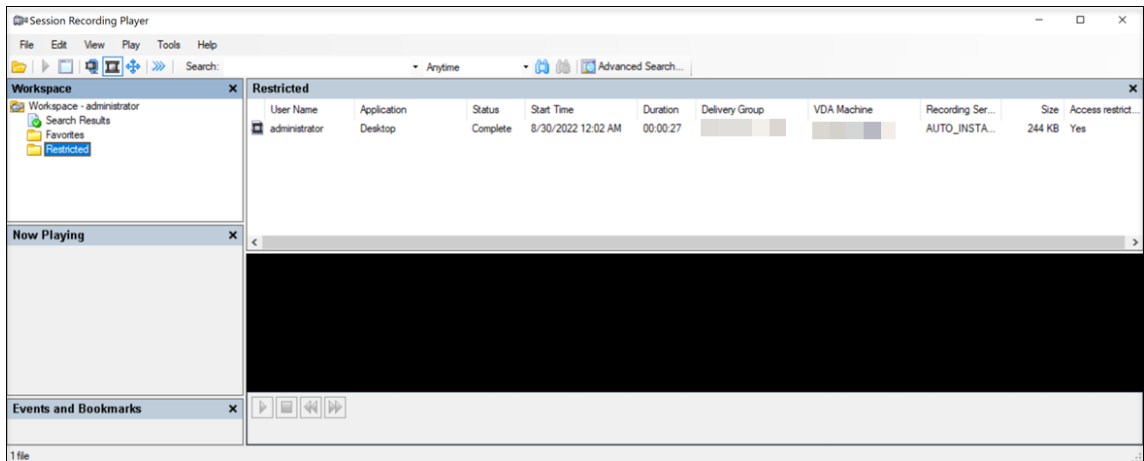

8. In the **Restricted** area, remove access restrictions as needed. With access restrictions removed, recordings are moved back to the **Search Results** area.

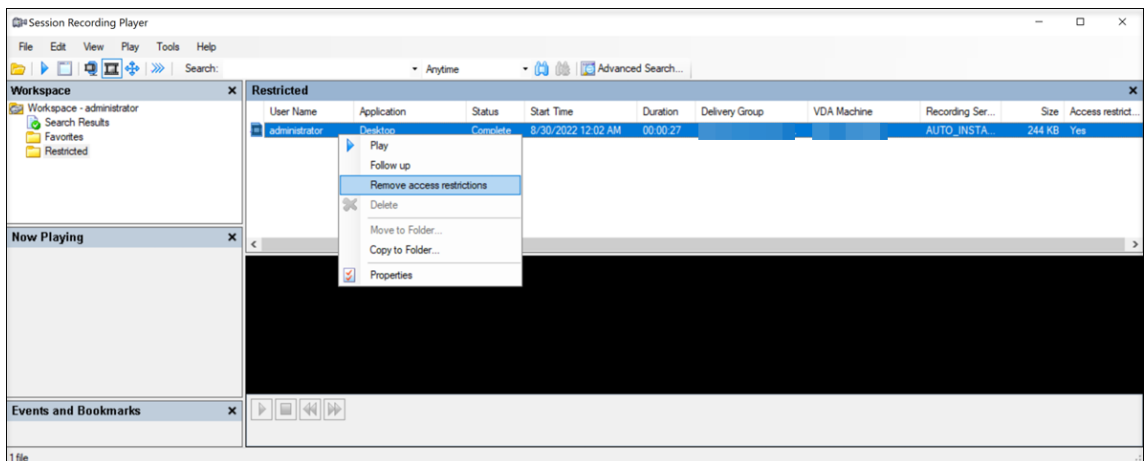

Open and play recordings

December 3, 2024

Open recordings

You can open session recordings in the Session Recording player in three ways:

- Perform a search using the Session Recording player. Recorded sessions that meet the search criteria appear in the search results area.
- Access recorded session files directly from your local disk drive or a shared drive.
- Access recorded session files from a Favorites folder.

When you open a file that was recorded without a digital signature, a warning message appears. It says that the origin and integrity of the file were not verified. If you are confident of the integrity of the file, click **Yes** in the warning window to open the file.

If playback justification logging is enabled, each time you play a recording, a dialog box appears, asking you to enter a playback justification. For more information, see [Playback logging](#).

The Session Recording player checks the Citrix Workspace app version before playing back a recorded session. If the player doesn't support the Citrix Workspace app version, an error is returned. To eliminate the error, select **Skip Citrix Workspace app version check** in **Session Recording Server Properties**.

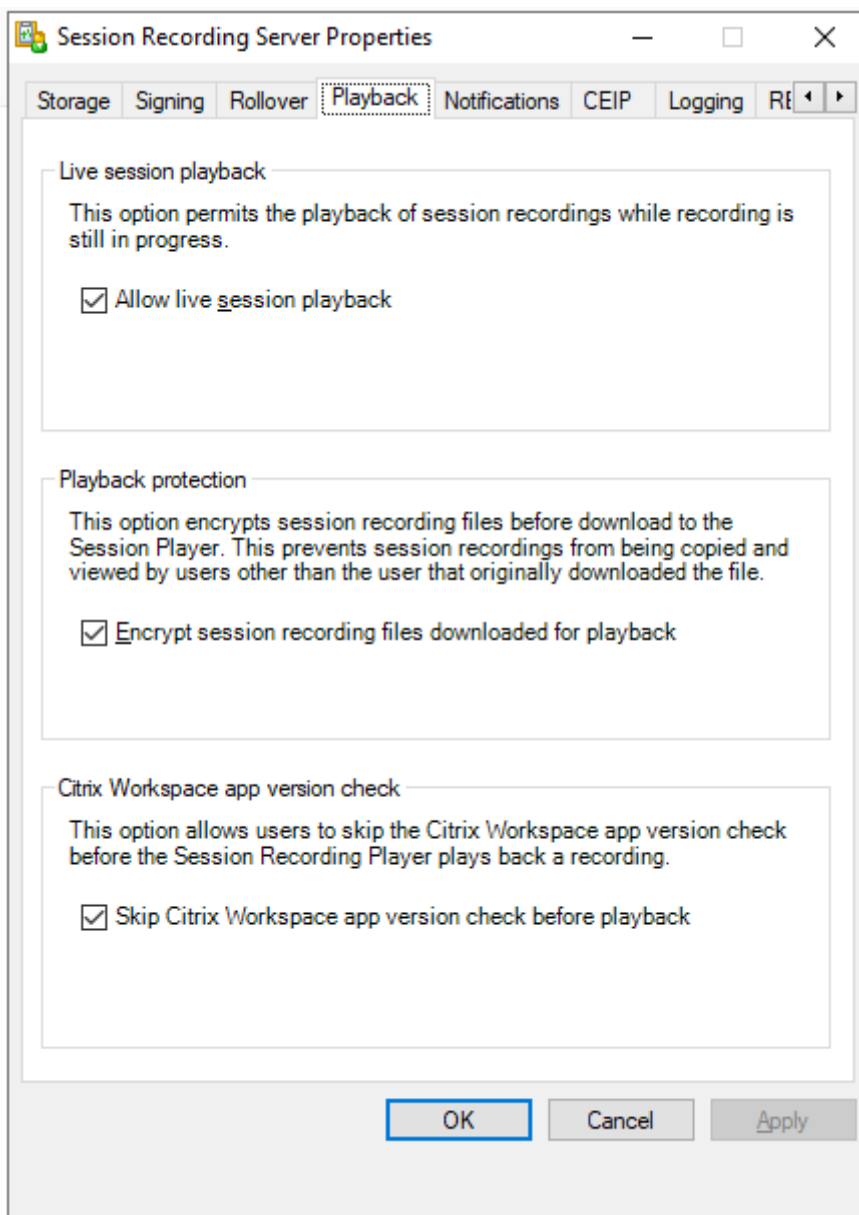

Note:

The Administrator Logging feature of Session Recording allows you to log the downloads of recordings in the Session Recording player. For more information, see [Administrator Logging](#).

Open a recording in the search results area

1. Log on to the machine where the Session Recording player is installed.
2. From the **Start** menu, choose **Session Recording Player**.
3. Perform a search.
4. If the search results area is not visible, select **Search Results** in the Workspace pane.
5. In the search results area, select the session you want to play.
6. Do any of the following:
 - Double-click the session.
 - Right-click and select **Play**.
 - From the **Session Recording Player** menu bar, choose **Play > Play**.

Open a recording by accessing the file

The name of a recording file begins with `i_`, followed by a unique alphanumeric file ID and then the `.icl` or `.icle` extension. The `.icl` extension denotes the recordings without playback protection applied. The `.icle` extension denotes the recordings with playback protection applied. Recorded session files are saved in a folder that incorporates the date the sessions were recorded. For example, the file for a session recorded on December 22, 2014, is saved in the folder path `2014\12\22`.

1. Log on to the workstation where the Session Recording player is installed.
2. From the **Start** menu, choose **Session Recording Player**.
3. Do any of the following:
 - From the **Session Recording Player** menu bar, choose **File > Open** and browse for the file.
 - Using Windows Explorer, navigate to the file and drag the file to the **Player** window.
 - Using Windows Explorer, navigate to and double-click the file.
 - If you created Favorites in the Workspace pane, select **Favorites** and open the file from the Favorites area in the same way you open files from the search results area.

Use favorites

Creating the **Favorites** folders allows you to quickly access recordings that you view frequently. These **Favorites** folders reference recorded session files that are stored on your workstation or on a network

drive. You can import and export these files to other workstations and share these folders with other Session Recording player users.

Note:

Only users with access rights to the Session Recording player can download the recorded session files associated with the **Favorites** folders. Contact your Session Recording administrator for the access rights.

To create a **Favorites** subfolder:

1. Log on to the workstation where the Session Recording player is installed.
2. From the **Start** menu, choose **Session Recording Player**.
3. In the **Session Recording Player** window, select the **Favorites** folder in your Workspace pane.
4. From the menu bar, choose **File > Folder > New Folder**. A new folder appears under the **Favorites** folder.
5. Type the folder name, then press **Enter** or click anywhere to accept the new name.

Use the other options that appear in the **File > Folder** menu to delete, rename, move, copy, import, and export the folders.

Play recordings

After you open a recorded session in the Session Recording player, you can navigate through the recorded sessions using these methods:

- Use the player controls to play, stop, pause, and increase or decrease playback speed.
- Use the seek slider to move forward or backward.

You can also navigate through the recorded session by going to the inserted markers and custom events.





Note:

- During playback of a recorded session, a second mouse pointer might appear. The second pointer appears at the point in the recording when the user navigated within Internet Explorer and clicked an image that was originally larger than the screen but was scaled down automatically by Internet Explorer. While only one pointer appears during the session, two might appear during playback.
- This version of Session Recording doesn't support SpeedScreen Multimedia Acceleration and the Flash quality adjustment policy setting. When this option is enabled, playback displays a black square.

- When you record a session with a resolution higher than or equal to 4096 x 4096, there might be fragments in the recording appearance.

Use the player controls

You can click the player controls in the lower part of the player window or access them by choosing **Play** from the **Session Recording Player** menu bar.

Player Control	Function
	Plays the selected session file.
	Pauses playback.
	Stops playback. If you click Stop , then Play , the recording restarts at the beginning of the file.
	Halves the current playback speed down to a minimum of one-quarter of the normal speed.
	Doubles the current playback speed up to a maximum of 32 times the normal speed.

Use the seek slider

Use the seek slider in the lower part of the player window to jump to a different position within the recorded session. You can drag the seek slider to the point in the recording you want to view or click anywhere on the slider bar to move to that location.

You can also use the following keyboard keys to control the seek slider:

Keyboard Key	Function
Home	Seeks to the beginning.
End	Seeks to the end.
Right Arrow	Seeks forward five seconds.
Left Arrow	Seeks backward five seconds.
Move the mouse wheel one notch down	Seeks forward 15 seconds.
Move the mouse wheel one notch up	Seeks backward 15 seconds.
Ctrl + Right Arrow	Seeks forward 30 seconds.

Keyboard Key	Function
Ctrl + Left Arrow	Seeks backward 30 seconds.
Page Down	Seeks forward one minute.
Page Up	Seeks backward one minute.
Ctrl + Move the mouse wheel one notch down	Seeks forward 90 seconds.
Ctrl + Move the mouse wheel one notch up	Seeks backward 90 seconds.
Ctrl + Page Down	Seeks forward six minutes.
Ctrl + Page Up	Seeks backward six minutes.

To adjust the speed of the seek slider: From the **Session Recording Player** menu bar, choose **Tools > Options > Player** and drag the slider to increase or decrease the seek response time. A faster response time requires more memory. The response might be slow depending on the size of the recordings and your machine's hardware.

Change the playback speed

You can set a playback speed in exponential increments from one-quarter normal playback speed to 32 times normal playback speed.

1. Log on to the workstation where the Session Recording player is installed.
2. From the **Start** menu, choose **Session Recording Player**.
3. From the **Session Recording Player** menu bar, choose **Play > Play Speed**.
4. Choose a speed option.

The speed adjusts immediately. Text indicating the exponential rate appears briefly in green in the lower part of the player window.

Highlight the idle periods of recorded sessions

Idle periods of a recorded session are the portions in which no action takes place. The Session Recording player can highlight the idle periods of recorded sessions during playback. The option is **On** by default. For more information, see [Highlight idle periods](#).

Skip over spaces where no action occurred

Fast review mode allows you to set the player to skip the portions of recorded sessions where no action takes place. This setting saves time for playback viewing. However, it doesn't skip animated

sequences such as animated mouse pointers, flashing cursors, or displayed clocks with second hand movements.

1. Log on to the workstation where the Session Recording player is installed.
2. From the **Start** menu, choose **Session Recording Player**.
3. From the **Session Recording Player** menu bar, choose **Play > Fast Review Mode**.

The option toggles on and off. Each time you choose it, its status appears briefly in green in the player window.

Change the playback display

You can do the following to change how recorded sessions appear in the player window:

- Pan and scale the image.
- Show playback in full screen
- Display the player window in a separate window
- Display a red border around the recorded session to differentiate it from the player window background.

Display the player window in full screen

1. Log on to the workstation where the Session Recording player is installed.
2. From the **Start** menu, choose **Session Recording Player**.
3. From the **Session Recording Player** menu bar, choose **View > Player Full Screen**.
4. To return to the original size, press **Esc** or **F11**.

Display the player window in a separate window

1. Log on to the workstation where the Session Recording player is installed.
2. From the **Start** menu, choose **Session Recording Player**.
3. From the **Session Recording Player** menu bar, choose **View > Player in Separate Window**. A new window appears, containing the player window. You can drag and resize the window.
4. To embed the player window in the main window, choose **View > Player in Separate Window**, or press **F10**.

Scale the session playback to fit the Player window

1. Log on to the workstation where the Session Recording player is installed.
2. From the **Start** menu, choose **Session Recording Player**.
3. From the **Session Recording Player** menu bar, choose **Play > Panning and Scaling > Scale to Fit**.

- **Scale to Fit (Fast Rendering)** shrinks images while providing good quality. Images are drawn quicker than using the High Quality option but the images and texts are not sharp. Use this option if you are experiencing performance issues when using the High Quality mode.
- **Scale to Fit (High Quality)** shrinks images while providing high quality. Using this option can cause the images to be drawn more slowly than the Fast Rendering option.

Pan the image

1. Log on to the workstation where the Session Recording player is installed.
2. From the **Start** menu, choose **Session Recording Player**.
3. From the **Session Recording Player** menu bar, choose **Play > Panning and Scaling > Panning**.
The pointer changes to a hand. And a small representation of the screen appears in the top right of the player window.
4. Drag the image. The small representation indicates where you are in the image.
5. To stop panning, choose one of the scaling options.

Display a red border around Session Recording

1. Log on to the workstation where the Session Recording player is installed.
2. From the **Start** menu, choose **Session Recording Player**.
3. From the **Session Recording Player** menu bar, choose **Tools > Options > Player**.
4. Select the **Show border around session recording** check box.
If the **Show border around session recording** check box is not selected, you can temporarily view the red border by clicking and holding down the left mouse button while the pointer is in the player window.

Cache recordings

December 3, 2024

Each time you open a recorded session file, the Session Recording player downloads the file from the location where the recordings are stored. If you download the same files frequently, you can save download time by caching the files on your workstation. Cached files are stored on your workstation in this folder:

userprofile\AppData\Local\Citrix\SessionRecording\Player\Cache

You can specify how much disk space is used for the cache. When the recordings fill the specified disk space, Session Recording deletes the oldest, least used recordings to make room for new recordings. You can empty the cache at any time to free up disk space.

Enable caching

1. Log on to the workstation where the Session Recording player is installed.
2. From the **Start** menu, choose **Session Recording Player**.
3. From the **Session Recording Player** menu bar, choose **Tools > Options > Cache**.
4. Select the **Cache downloaded files on local machine** check box.
5. To limit the amount of disk space used for caching, select the **Limit amount of disk space to use** check box and specify the number of MB to be used for cache.
6. Click **OK**.

Empty caches

1. Log on to the workstation where the Session Recording player is installed.
2. From the **Start** menu, choose **Session Recording Player**.
3. From the **Session Recording Player** menu bar, choose **Tools > Options > Cache**.
4. Select the **Cache downloaded files on local machine** check box.
5. In the Session Recording player, choose **Tools > Options > Cache**.
6. Click **Purge Cache** and **OK** to confirm the action.

Highlight idle periods

December 3, 2024

Idle periods of a recorded session are the portions in which no action takes place. The Session Recording player can highlight the idle periods of recorded sessions during playback. The option is **On** by default.

Note: Idle periods are not highlighted when playing back live sessions with the Session Recording player.

To highlight the idle periods of recorded sessions, do the following:

1. Log on to the workstation where the Session Recording player is installed.
2. From the **Start** menu, choose **Session Recording Player**.
3. From the **Session Recording Player** menu bar, choose **View > Idle Periods** and select or clear the check box.

Use events and bookmarks

December 3, 2024

You can use events and bookmarks to help you navigate through recorded sessions.

Citrix-defined events are inserted to sessions while the sessions are recorded. You can also use the Event API and a third-party application to insert custom events. Events are saved as part of the session file. You cannot delete or alter them using the Session Recording player.

Bookmarks are markers that you insert in a recorded session during session playback using the Session Recording player. After insertion, bookmarks are associated with the recorded session until you delete them. However, they are not saved as part of the session file but stored as separate `.icl` files in the **Bookmarks** cache folder on the Session Recording player, for example, `C:\Users\SpecificUser\AppData\Local\Citrix\SessionRecording\Player\Bookmarks`, with the same file name as the `.icl` recording file. To play back a recording using bookmarks on a different player, copy the `.icl` files to the **Bookmarks** cache folder on that player. By default, each bookmark is labeled with the text “Bookmark,” but you can change it to any text annotation up to 128 characters long.

Events appear as yellow dots and bookmarks appear as blue squares in the lower part of the player window. Moving the mouse over the dots and squares displays the text label associated with them. You can also display the events and bookmarks in the **Events and Bookmarks** list of the Session Recording player. They appear in this list with their text labels and the times in the recorded session at which they appear, in chronological order.

You can use events and bookmarks to help you navigate through recorded sessions. By going to an event or bookmark, you can skip to the point in the recorded session where the event or bookmark is inserted.

Display events and bookmarks in the list

The **Events and Bookmarks** list displays the events and bookmarks inserted in the recorded session that is currently playing. It can show events only, bookmarks only, or both.

1. Log on to the workstation where the Session Recording player is installed.
2. From the **Start** menu, choose **Session Recording Player**.
3. Move the mouse pointer to the **Events and Bookmarks** list area and right-click to display the menu.
4. Choose **Show Events Only**, **Show Bookmarks Only**, or **Show All**.

Insert a bookmark

1. Log on to the workstation where the Session Recording player is installed.
2. From the **Start** menu, choose **Session Recording Player**.
3. Begin playing the recorded session to which you want to add a bookmark.
4. Move the seek slider to the position where you want to insert the bookmark.
5. Move the mouse pointer to the player window area and right-click to display the menu.
6. Add a bookmark with the default **Bookmark** label or create an annotation:
 - To add a bookmark with the default **Bookmark** label, choose **Add Bookmark**.
 - To add a bookmark with a descriptive text label that you create, choose **Add Annotation**. Type the text label that you want to assign to the bookmark, up to 128 characters. Click **OK**.

Add or change an annotation

After a bookmark is created, you can add an annotation to it or change its annotation.

1. Log on to the workstation where the Session Recording player is installed.
2. From the **Start** menu, choose **Session Recording Player**.
3. Begin playing the recorded session containing the bookmark.
4. Ensure that the **Events and Bookmarks** list is displaying bookmarks.
5. Select the bookmark in the **Events and Bookmarks** list and right-click to display the menu.
6. Choose **Edit Annotation**.
7. In the window that appears, type the new annotation and click **OK**.

Delete a bookmark

1. Log on to the workstation where the Session Recording player is installed.
2. From the **Start** menu, choose **Session Recording Player**.
3. Begin playing the recorded session containing the bookmark.
4. Ensure that the **Events and Bookmarks** list is displaying bookmarks.
5. Select the bookmark in the **Events and Bookmarks** list and right-click to display the menu.
6. Choose **Delete**.

Go to an event or bookmark

Going to an event or bookmark causes the Session Recording player to go to the point in the recorded session where the event or bookmark is inserted.

1. Log on to the workstation where the Session Recording player is installed.

2. From the **Start** menu, choose **Session Recording Player**.
3. Begin playing a session recording containing events or bookmarks.
4. Go to an event or bookmark:
 - In the lower part of the player window, click the dot or square representing the event or bookmark to go to the event or bookmark.
 - In the **Events and Bookmarks** list, double-click the event or bookmark to go to it. To go to the next event or bookmark, select any event or bookmark from the list, right-click to display the menu, and choose **Seek to Bookmark**.

Session Recording web player

December 3, 2024

The web player lets you use a web browser to view and play back recorded sessions. Using the web player, you can:

- Search for recordings by using filters.
- View and play back both live and completed recordings with tagged events listed in the right pane.
- configure cache memory for storing recordings during playback.
- Highlight idle periods.
- Leave comments about a recording and set a severity for each comment.
- Share URLs of recordings.
- View graphical event statistics for each recording.
- View data points related to each recorded session.

Access the web player

December 3, 2024

The URL of the web player website is `http(s)://<FQDN of Session Recording server>/WebPlayer`. To ensure the use of HTTPS, add an SSL binding to the website in IIS and update the `SsRecWebSocketServer.config` configuration file.

Note:

- When logging on to the web player website, domain users do not need to enter credentials while non-domain users must.
- Supported browsers include Google Chrome, Microsoft Edge, and Firefox.
- To have the web player function properly, make sure you enable WebGL in Firefox.

This article guides you through the process of installing and enabling the web player and the process of configuring HTTPS.

Install the web player

Install the web player on the Session Recording server only. Double-click SessionRecordingWeb-Player.msi and follow the instructions to complete your installation. For more information about installing Session Recording, see [Install, upgrade, and uninstall](#).

Starting from Version 2103, Session Recording migrates the WebSocket server to IIS. With the web player installed, the **SessionRecordingRestApiService**, **SessionRecordingWebStreaming**, and **WebPlayer** applications appear in IIS.

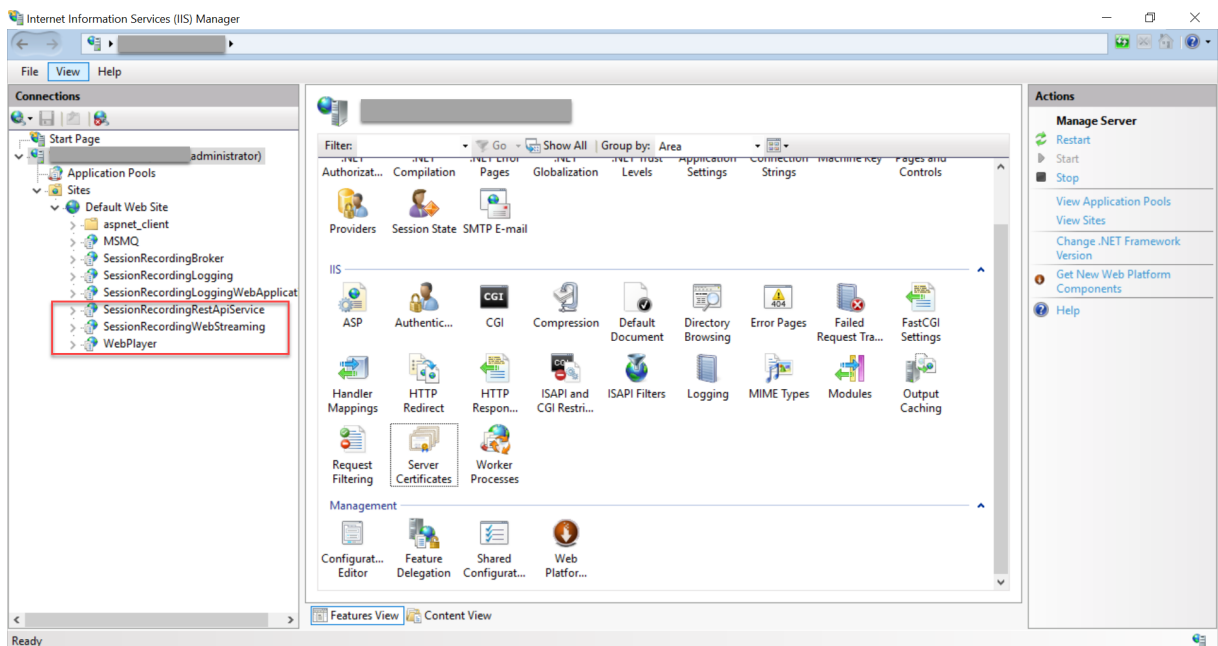

A fresh installation of Session Recording 2103 and later connects your web browser to the WebSocket server hosted in IIS when you access the web player website. The WebSocket server hosted in IIS is versioned 2.0, as indicated by the registry value **WebSocketServerVersion** under the registry key at `HKEY_LOCAL_MACHINE\SOFTWARE\Citrix\SmartAuditor\Server`.

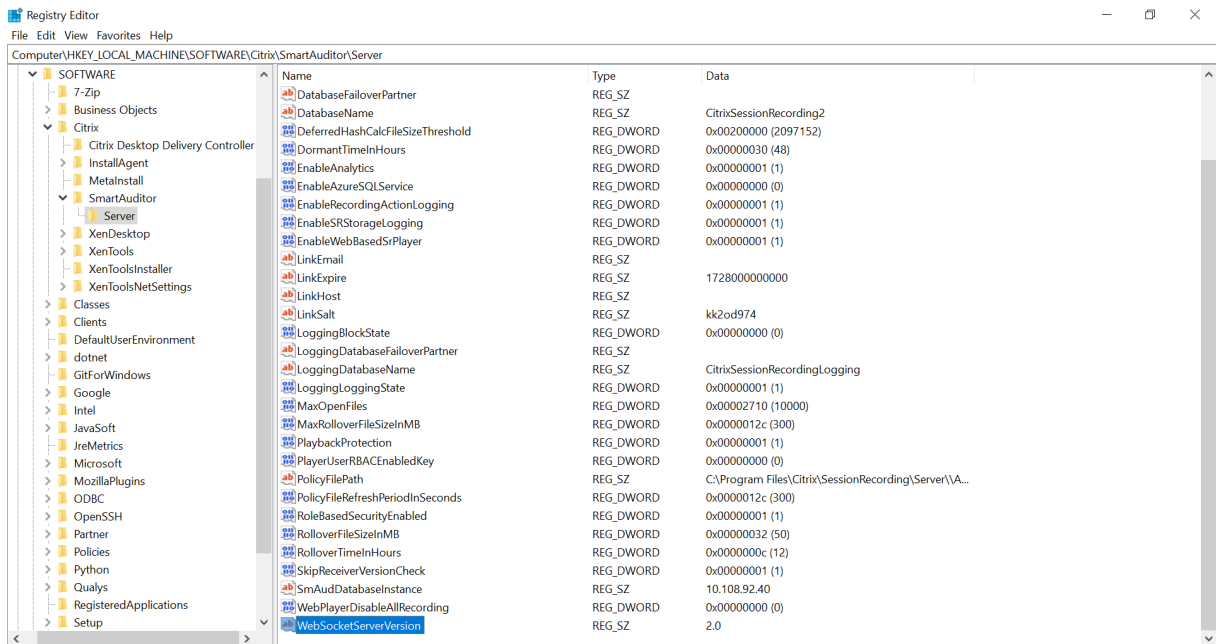

An upgrade installation from an earlier version to Session Recording 2103 and later connects your web browser to the Python-based WebSocket server. To connect to the WebSocket server hosted in IIS, run the **<Session Recording server installation path>\Bin\SsRecUtils.exe -enablestreamingservice** command. To connect back to the Python-based WebSocket server, run the **<Session Recording server installation path>\Bin\SsRecUtils.exe -disablestreamingservice** command. The Python-based WebSocket server is versioned 1.0.

Enable the web player

The web player is enabled by default.

- To disable the web player, start a Windows command prompt and run the **<Session Recording Server installation path>\Bin\SsRecUtils.exe -disablewebplayer** command.
- To enable the web player, start a Windows command prompt and run the **<Session Recording Server installation path>\Bin\SsRecUtils.exe -enablewebplayer** command.

Configure HTTPS

The URL of the web player website is **http(s)://<FQDN of Session Recording server>/WebPlayer**. To ensure the use of HTTPS, add an SSL binding to the website in IIS and update the **SsRecWebSocketServer.config** configuration file.

Note:

When logging on to the web player website, domain users do not need to enter credentials while non-domain users must.

To use HTTPS to access the web player website, complete the following steps:

1. Add an SSL binding in IIS.

a) Obtain an SSL certificate in PEM format from a trusted Certificate Authority (CA).

Note:

Most popular browsers such as Google Chrome and Firefox no longer support the common name in a Certificate Signing Request (CSR). They enforce Subject Alternative Name (SAN) in all publicly trusted certificates. To use the web player over HTTPS, take the following actions accordingly:

- When a single Session Recording Server is in use, update the certificate of the Session Recording Server to a SAN certificate.

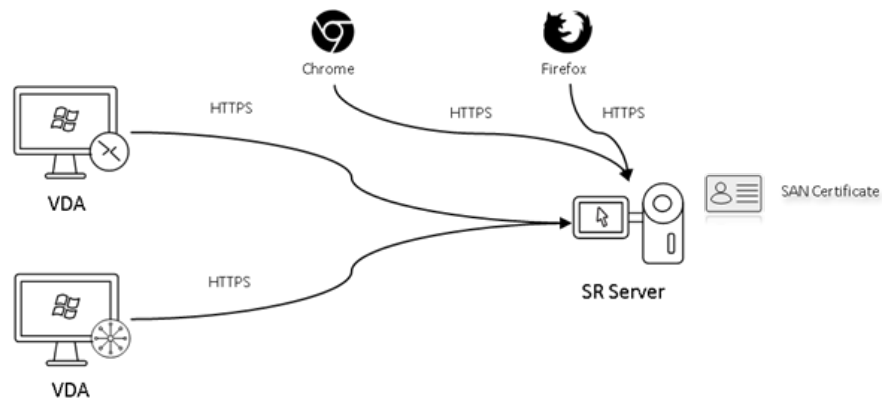

- When load balancing is in use, ensure that a SAN certificate is available both on Citrix ADC and on each Session Recording Server.

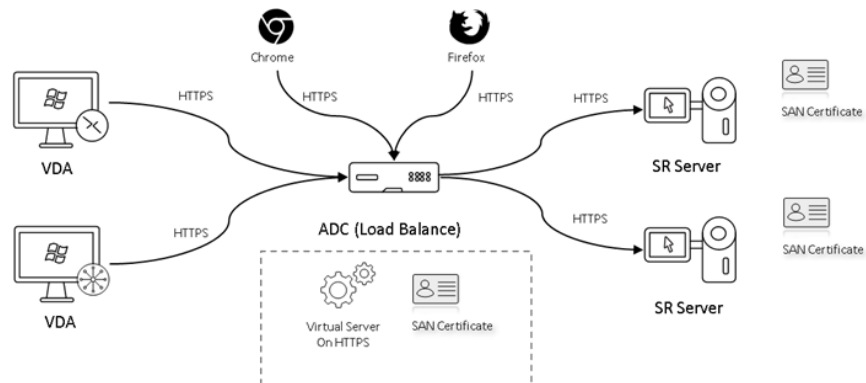

b) On IIS, right-click the website and select **Add Bindings**. The **Site Bindings** dialog box ap-

pears.

- c) Click **Add** in the upper right corner. The **Add Site Binding** dialog box appears.
- d) Select **https** from the **Type** list and select your SSL certificate.

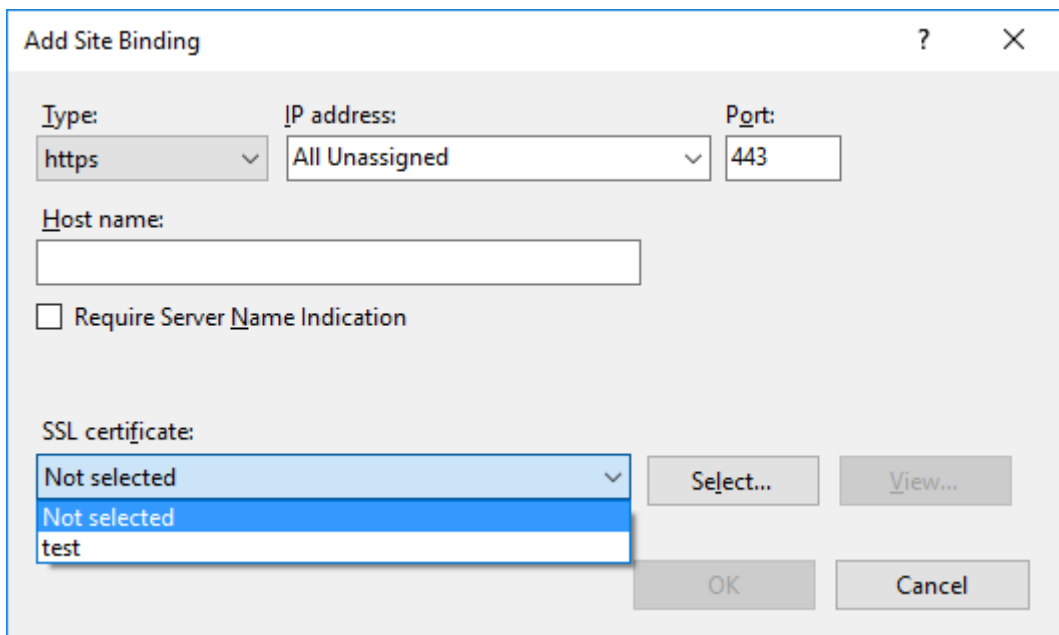
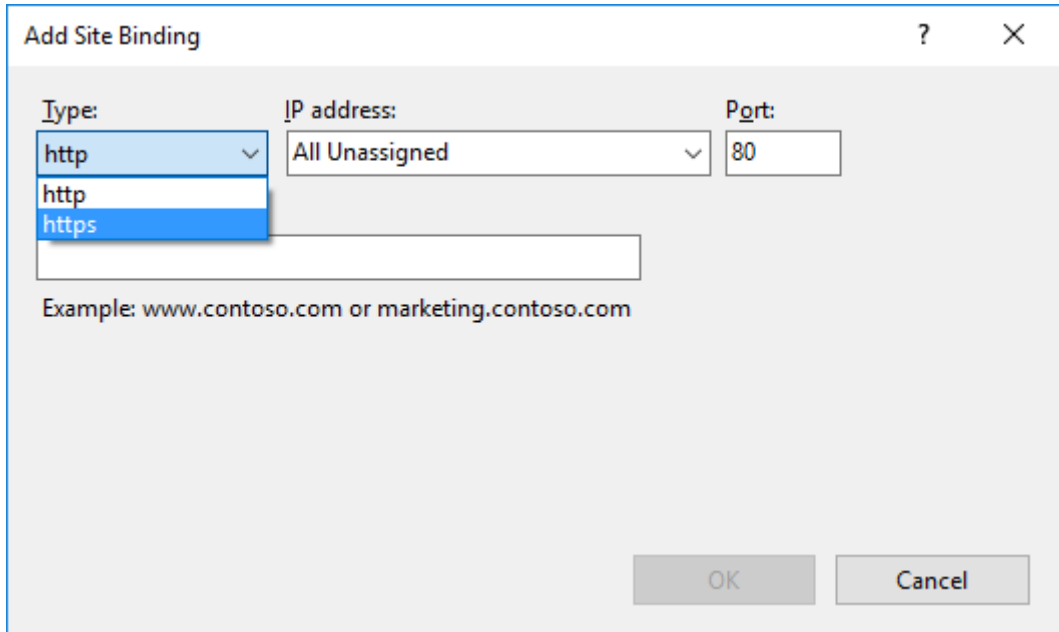

- e) Click **OK**.

2. Update the `SsRecWebSocketServer.config` configuration file.

- a) Locate and open the `SsRecWebSocketServer.config` configuration file.

The `SsRecWebSocketServer.config` configuration file is typically located in the <

Session Recording Server installation path>\Bin\ folder.

- b) Enable TLS by editing TLSEnable=1 and ignore the **ServerPort**, **SSLCert**, and **SSLKey** fields.
- c) Save your changes.

Hide or show content on the web player home page

December 3, 2024

After you log on, the web player home page might hide or show content based on whether the following option is selected in **Session Recording Server Properties**.



- With the option selected, the web player home page hides all content. Recordings can be accessed only by way of their URLs. Recording URLs are provided in email alerts that are sent to specified recipients. For information about email alerts, see [Configure event response policies](#). You can also share recording URLs through the **Share Current Playback** control on recording playback pages. See descriptions later in this article.

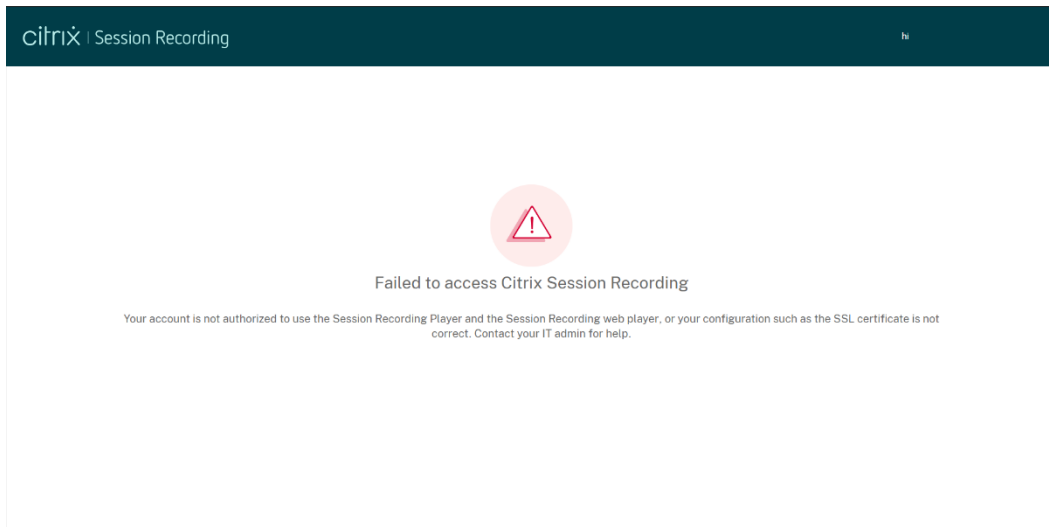

- With the option unselected, the web player home page shows content similar to the following screen capture. Click **All Recordings** in the left navigation to refresh the page and display new recordings if there are any. Scroll down the webpage to select recordings to view or use filters to customize your search results. For live recordings, the **Duration** column shows **Live** and the play button appears green.

Start Time	User	Host	Client	Events	Events Only	Recording Server	Duration	Action
May 19, 2021 5:36 PM	Administrator			0	False	SERVER	Live	
May 19, 2021 5:23 PM				23	True	SERVER	00:01:57	
May 19, 2021 5:20 PM				1	True	SERVER	00:02:28	
May 14, 2021 6:48 PM	Administrator			0	False	SERVER	00:00:58	
May 14, 2021 6:46 PM	Administrator			0	False	SERVER	00:00:50	
May 14, 2021 6:31 PM	Administrator			0	False	SERVER	00:00:35	
May 14, 2021 6:20 PM	Administrator			0	False	SERVER	00:00:41	
May 14, 2021 5:58 PM	Administrator			0	False	SERVER	00:02:14	
May 14, 2021 3:00 PM	Administrator			0	False	SERVER	00:00:37	
May 14, 2021 2:58 PM	Administrator			0	False	SERVER	00:00:31	
May 14, 2021 2:56 PM	Administrator			0	False	SERVER	00:00:40	

To show all recording files of a recorded session, select a recording on the list and click the **Follow up** icon. The **Follow up** icon is available only when a recording is selected.

Start Time	User	Host	Client	Events	Events Only	Recording Server	Duration	Action
May 19, 2021 5:36 PM	Administrator			0	False	SERVER	Live	
May 19, 2021 5:23 PM				23	True	SERVER	00:01:57	
May 19, 2021 5:20 PM				1	True	SERVER	00:02:28	
May 14, 2021 6:48 PM	Administrator			0	False	SERVER	00:00:58	
May 14, 2021 6:46 PM	Administrator			0	False	SERVER	00:00:50	
May 14, 2021 6:31 PM	Administrator			0	False	SERVER	00:00:35	
May 14, 2021 6:20 PM	Administrator			0	False	SERVER	00:00:41	

For a description of the recording items, see the following table.

Item	Description
Start time	The recording start time. Click the up and down arrows to list recordings in chronological order.
User	The user whose session was recorded. Click the up and down arrows to concentrate recordings of a user on the list and arrange users in alphabetical order.
Host	The host name of the VDA where the recorded session was hosted. Click the up and down arrows to arrange the VDA host names in alphabetical order.
Client	The name of the client device where the session was running. Click the up and down arrows to arrange the client host names in alphabetical order.
Events	The quantity of events in the recording. Click the up and down arrows to arrange recordings on the list by event quantity.
Events Only	Indicates a screen recording or an event-only recording. An event-only recording played in the web player contains an event statistics pie chart and histogram. The pie chart and histogram hold static throughout playback.
Recording Server	The Session Recording Server that processes recording data sent from VDAs.
Duration	The time length of the recording. Click the up and down arrows to arrange recordings on the list by time length.

Search for recordings

December 3, 2024

Search for recordings by using filters

You can search for recordings by using filters in the web player. The available filters include host name, client name, user name, application, client IP address, event text, event type, and time.

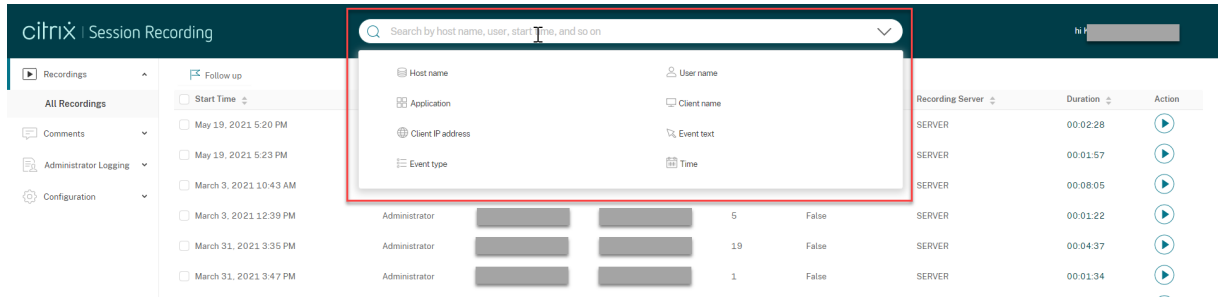

For example, after you select the host name filter, the following dialog box appears. Type in the host name (of the VDA where recorded sessions are hosted) and click **Search** to filter out irrelevant recordings and display only the relevant ones.

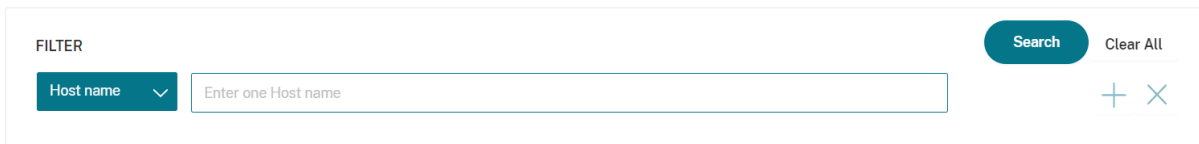

You can change to a different filter by clicking the currently selected **Host name**, as shown in the following screen capture. All filters are listed after you click **Host name**. Select a different filter as needed.

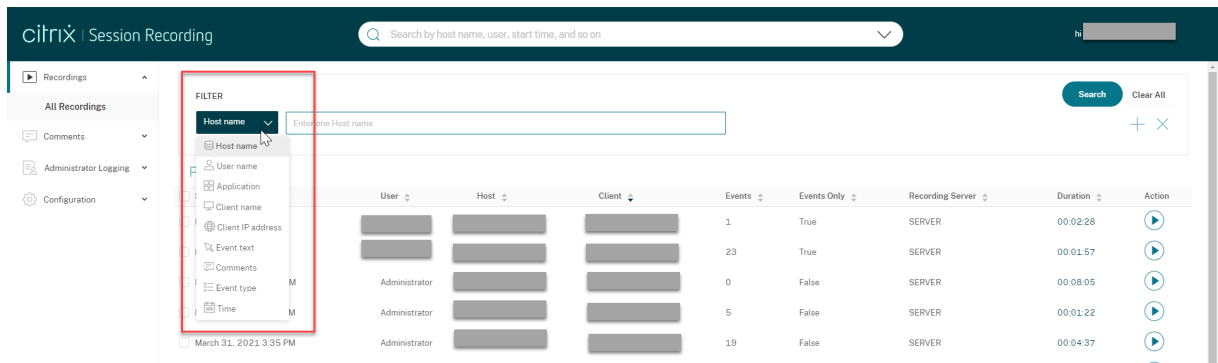

You can also click the **+** symbol to add filters.

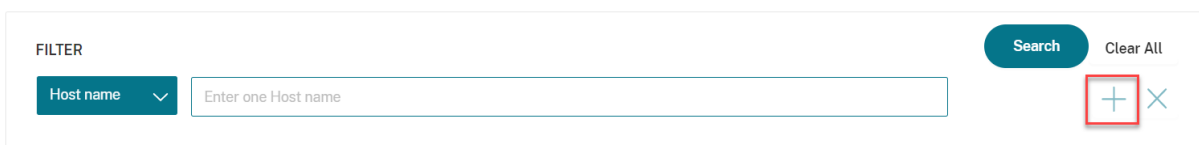

For example, you can add the **Time** filter as shown in the following screen.

The screenshot shows a web interface for session recording. At the top left is a 'FILTER' section with two dropdown menus: 'Host name' and 'Time'. The 'Host name' dropdown is open, showing a search box with the placeholder text 'Enter one Host name'. The 'Time' dropdown is also open, showing three sub-sections: 'Start date' and 'End date' (each with a 'Select date' button), 'Start Time' and 'End time' (each with a 'Select time' button), and 'Duration' (with a dropdown set to 'At least', an input field, and another dropdown set to 'Seconds'). To the right of the filter panel are 'Search' and 'Clear All' buttons, and a '+' icon. Below the filter panel is a table with columns: 'Start Time', 'User', 'Host', 'Client', 'Events', 'Duration', and 'Action'. The first row of the table contains the following data: 'February 9, 2021 5:22 PM', 'qh', two greyed-out cells, '5', '00:30:07', and a play button icon.

The **Time** filter consists of recording start date, start time, and duration.

Show all recordings of a session

There are two ways to show all recordings of a session in the Session Recording web player:

Method 1:

Select a recording and click the **Follow up** button to show all recordings of the recorded session.

Method 2:

Select a recording to play and click **View playlist** in the upper right corner of the playback page.

Place access restrictions on recordings

December 3, 2024

You place access restrictions on target recordings in addition to role-based access control through [recording viewing policies](#). Restricted recordings are accessible only to users and user groups that are assigned the **PrivilegedPlayer** role through the Session Recording Authorization Console.

Note:

Placing access restrictions on live recordings is not supported.

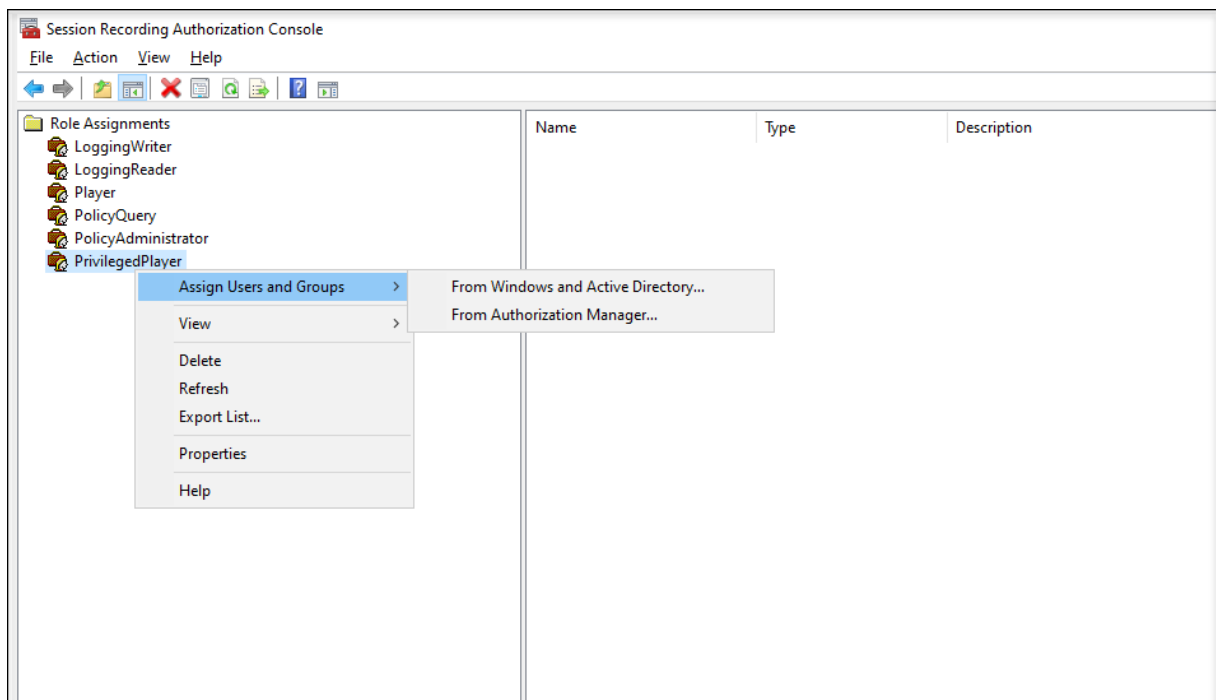

The following section walks you through the process of placing and removing access restrictions on target recordings.

1. Enter the URL of your web player website in the address bar of a supported browser.

The URL format is **http(s)://<FQDN of Session Recording server>/WebPlayer**.

Supported browsers include Google Chrome, Microsoft Edge, and Firefox.

2. In the left navigation of the web player page, expand the **Recordings** menu.
3. On the **All Recordings** page, select one or more target recordings.
4. Click the **Place access restrictions** icon on top of the recording list.

Users and user groups, assigned either the **Player** or the **PrivilegedPlayer** role, are allowed to place access restrictions on recordings. The **Restricted** menu is available only for users and user groups assigned the **PrivilegedPlayer** role.

View for the **PrivilegedPlayer** role:

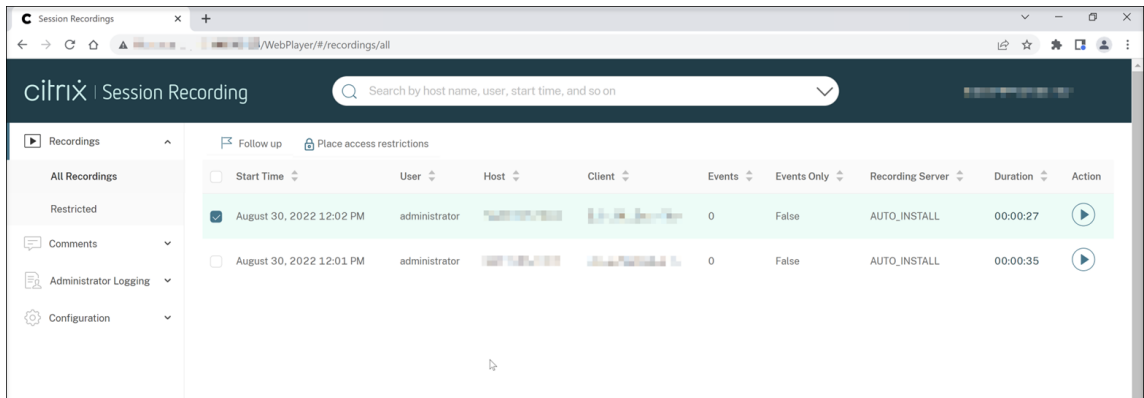

View for the **Player** role:

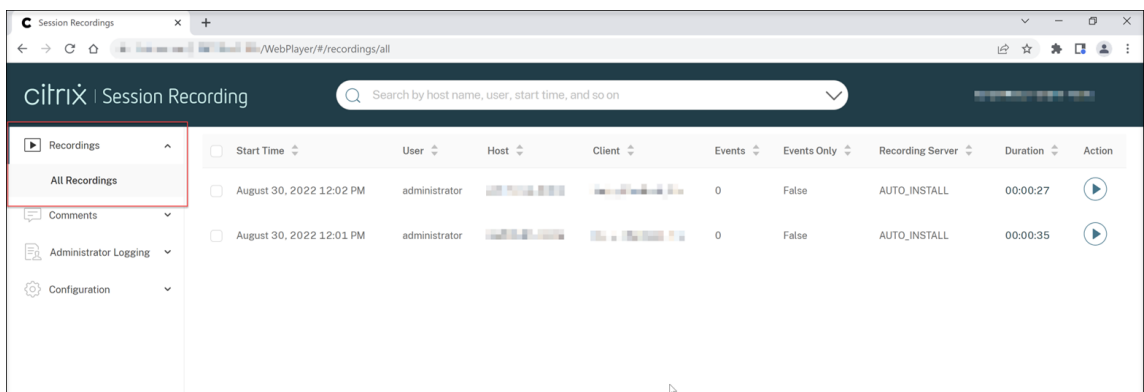

5. Click **Confirm**.

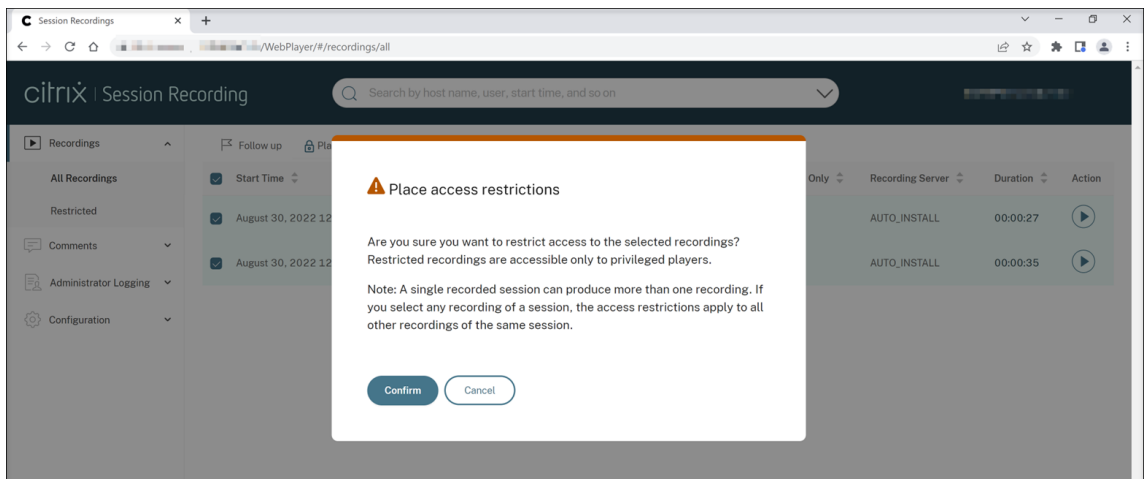

6. Verify that the selected recordings on which you placed access restrictions are moved from the **All Recordings** page to the **Restricted** page.

The **Restricted by** column shows who placed access restrictions on the relevant recordings.

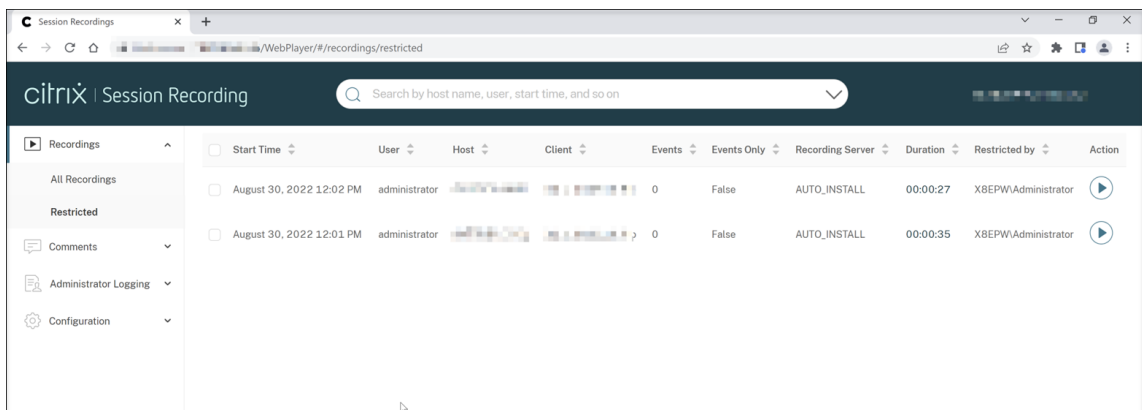

7. On the **Restricted** page, remove access restrictions as needed. With access restrictions removed, recordings are moved back to the **All Recordings** page.

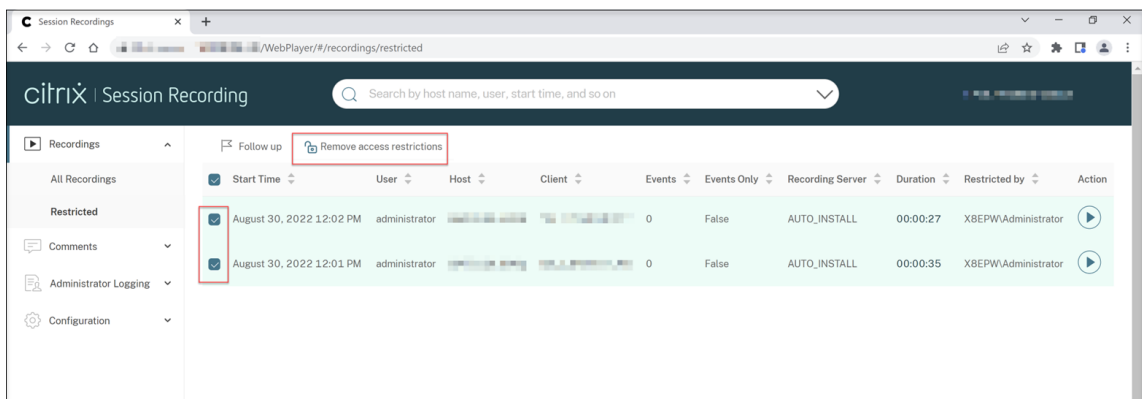

Open and play recordings

December 3, 2024

You can play live and completed recordings in the web player. On the recordings page, each recording has a play button on the right side, next to the **Duration** item.

Start Time	User	Host	Client	Events	Events Only	Audio Recording	Lazy Screen Recording	Recording Server	Duration	Action
Nov 16, 2023 3:12:35 PM				28	False	Enabled	False	35854	00:05:15	[Play]
Nov 16, 2023 3:02:43 PM				11	False	Enabled	False	35854	00:05:15	[Play]
Nov 16, 2023 2:44:24 PM				0	False	Disabled	False	35854	00:05:24	[Play]
Nov 16, 2023 2:28:55 PM				4	False	Disabled	False	35854	00:08:34	[Play]
Nov 16, 2023 2:17:25 PM				2	False	Disabled	False	35854	00:04:02	[Play]
Nov 16, 2023 2:09:13 PM				4	False	Disabled	False	35854	00:05:23	[Play]
Nov 15, 2023 4:47:54 PM				3	False	Disabled	False	35854	00:06:26	[Play]
Nov 15, 2023 4:36:53 PM				0	False	Disabled	False	35854	00:08:07	[Play]
Nov 15, 2023 4:29:46 PM				0	False	Disabled	False	35854	00:05:29	[Play]
Nov 15, 2023 4:04:27 PM				6	False	Disabled	False	35854	00:08:23	[Play]
Nov 15, 2023 3:25:51 PM				18	False	Disabled	False	35854	00:05:50	[Play]
Nov 15, 2023 3:16:06 PM				6	False	Disabled	False	35854	00:04:29	[Play]
Nov 15, 2023 2:53:08 PM				0	False	Disabled	False	35854	00:08:23	[Play]

Tip:

For the **Player** role, the **Recordings** menu in the left navigation shows only the **All Recordings** submenu.

For the **PrivilegedPlayer** role, the **Recordings** menu shows both the **All Recordings** and the **Restricted** submenus.

Click the play button. The playback page appears. Playback starts after memory caching.

Playback of a screen recording:

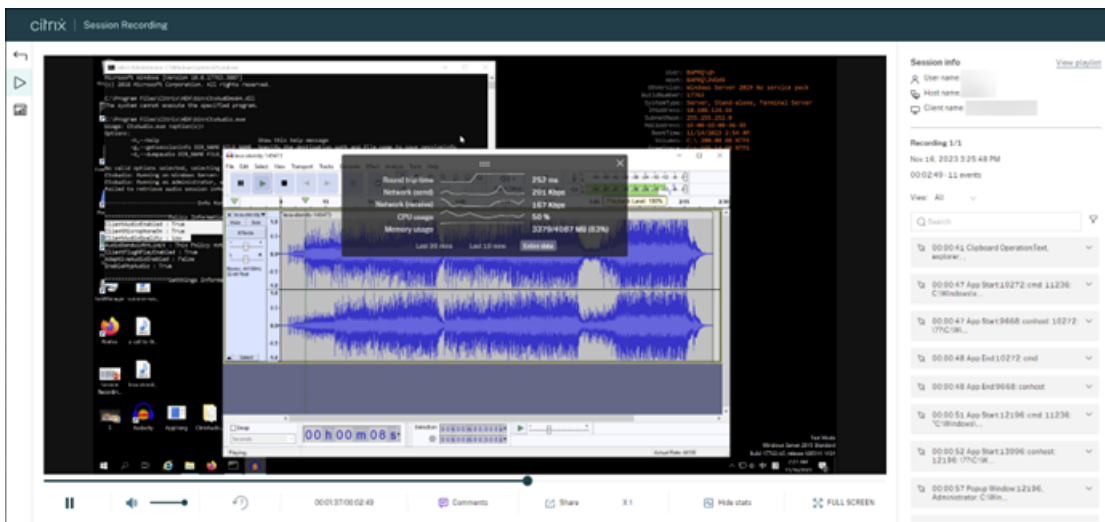

Playback of an event-only recording:



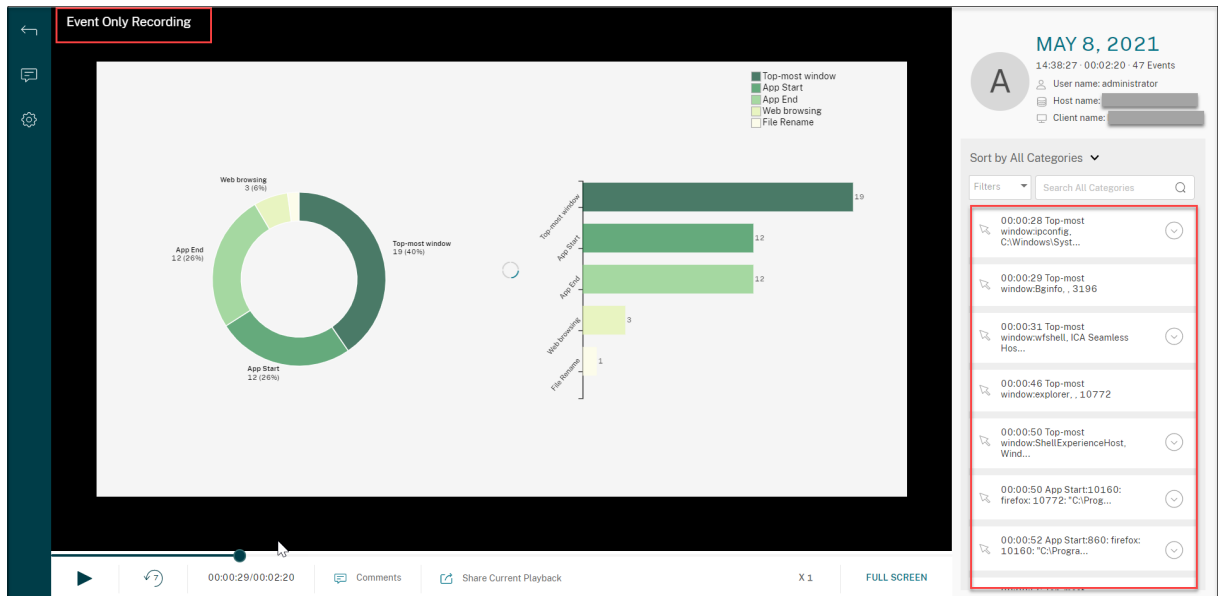

An event-only recording played in the web player contains an event statistics pie chart and histogram. The pie chart and histogram hold static throughout playback. You can navigate to a specific event from within the right pane.







Tip:

- Clicking the session progress time lets you switch to the absolute date and time the session was recorded.
- For an event-only recording, the play icon in the upper left corner is unavailable.

For a description of the player controls, see the following table:

Player Control	Description
	Plays the selected recording file.
	Pauses playback.
	Mutes/unmutes audio playback and adjusts the volume using the slider.
	You can drag the progress bar during playback. Idle periods of recorded sessions are highlighted during playback.
	Seeks backward 7 seconds.
<p>00:05:06/00:13:33</p>	Indicates the current position of the recording playback and the total recording duration. The time format is HH:MM:SS.

Player Control	Description
 Comments	Lets you click and leave a comment about the recording being played.
 Share Current Playback	Lets you click and copy the URL of the current recording to the clipboard.
 Show stats	Shows the overlay that features data points related to the recorded session.
 Hide stats	Hides the session data overlay.
X 1	Indicates the current speed of playback. Click the icon to switch between options including X0.5, X1, X2, and X4.
FULL SCREEN	Displays the playback in full screen.
Exit full screen	Displays the playback within the webpage.

In the right pane of the playback page, the **Events** and **Comments** filters, quick search box, and some recording data are available, for example:

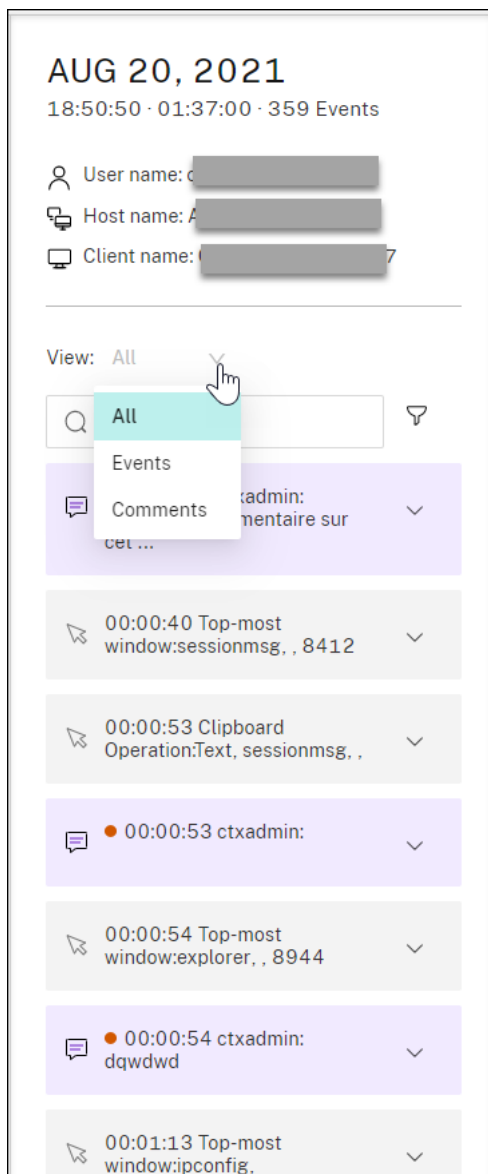

- The date and time on the web player machine. In this example, **AUG 20, 2021** and **18:50:50**.
- The duration of the recording in playback. In this example, **01:37:00**.
- The number of events in the recording. In this example, **359 EVENTS**.
- The name of the user whose session was recorded.
- The host name of the VDA where the recorded session was hosted.
- The name of the client device where the session was running.
- Options for sorting search results: Select **All**, **Events**, or **Comments** to sort search results.
- Event filters. You can select more than one filter to search for events in the current recording.
Click the icon to expand the display of events. For example:

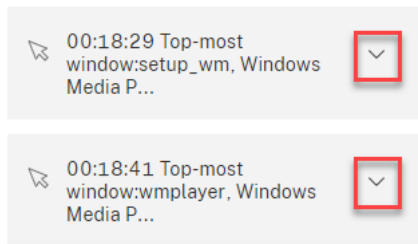

- Event list. Clicking an event on the list takes you to the position of the event in the recording.
- Quick search box. The **search events** quick search box helps to quickly narrow down a list of events in the current recording.

Configure preferences

December 3, 2024

To configure preferences for your web player, navigate to **Configuration > Preferences** on the web player page.

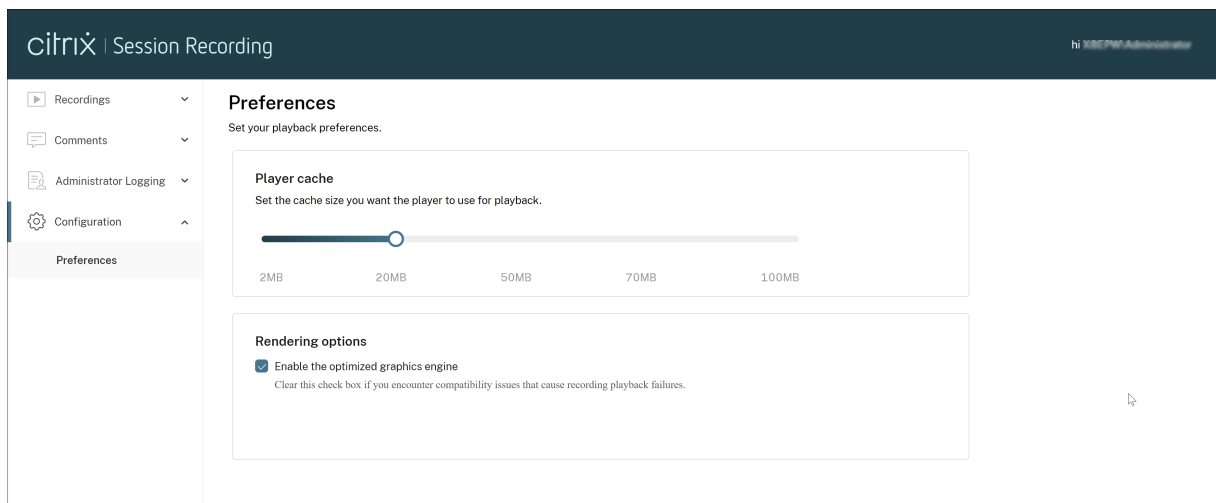

You can configure the following preferences for your web player:

- **Player cache.** Drag the slider to set the cache size you want the player to use for playback.
- **Optimized graphics engine.** We have optimized the graphics engine to improve the performance of the web player. The optimized engine is enabled by default. If you encounter compatibility or other issues with the optimized engine, you can disable it by clearing the check box.

Increase the transport packet size for the web player

December 3, 2024

1. Locate the **Web** configuration file under <Session Recording installation path>/WebSocketServer.
2. Open the **Web** configuration file.
3. Edit the **BlockSizeMultiple** value.

The default value is 1 (4 KB). We recommend you set the value to 8 (32 KB).

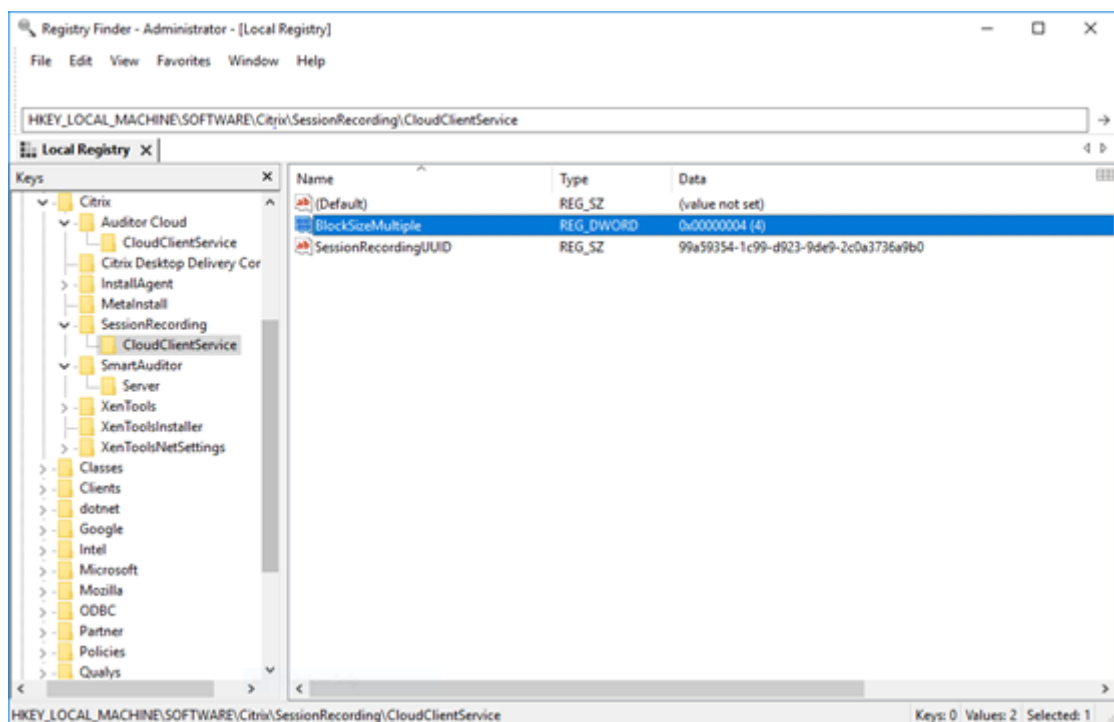

Highlight idle periods

December 3, 2024

Session Recording can record idle events and highlight idle periods in the web player.

Tip:

Idle events are not visible in the Session Recording player because idle events are saved in the Session Recording database but not in the relevant recording files (.icl files).

To customize the idle event feature, set the following registry keys at `HKEY_LOCAL_MACHINE\SOFTWARE\Citrix\SmartAuditor\SessionEvents`.

Registry key	Default value	Description
<code>DisableIdleEvent</code>	0	To disable the idle event feature, set the value to 1 . To enable the idle event feature, set the value to 0 .
<code>IdleEventThrottle</code>	30 seconds	If there is no user activity (including graphics changes and keyboard/mouse inputs) longer than the time threshold set by the registry key, an idle event is recorded. The idle period is highlighted when the recorded session plays back on the Session Recording web player.
<code>IdleEventActiveThrottle</code>	2 seconds	Only a specified number of graphics changes within a specified amount of time qualify as user activities. By default, at least three packets within 2 seconds can qualify as user activities.
<code>IdleEventActivePktNumThrottle</code>	3 packets	Only a specified number of graphics changes within a specified amount of time qualify as user activities. By default, at least three packets within 2 seconds can qualify as user activities.
<code>IdleEventActivePktSizeThrottle</code>	300 bytes	Graphics packets smaller than the key value are ignored and the relevant time duration is regarded as idle.

Use events and comments

December 3, 2024

In the right pane of the playback page, the **Events** and **Comments** filters are available. You can use events and comments to help you navigate through recorded sessions in the web player.

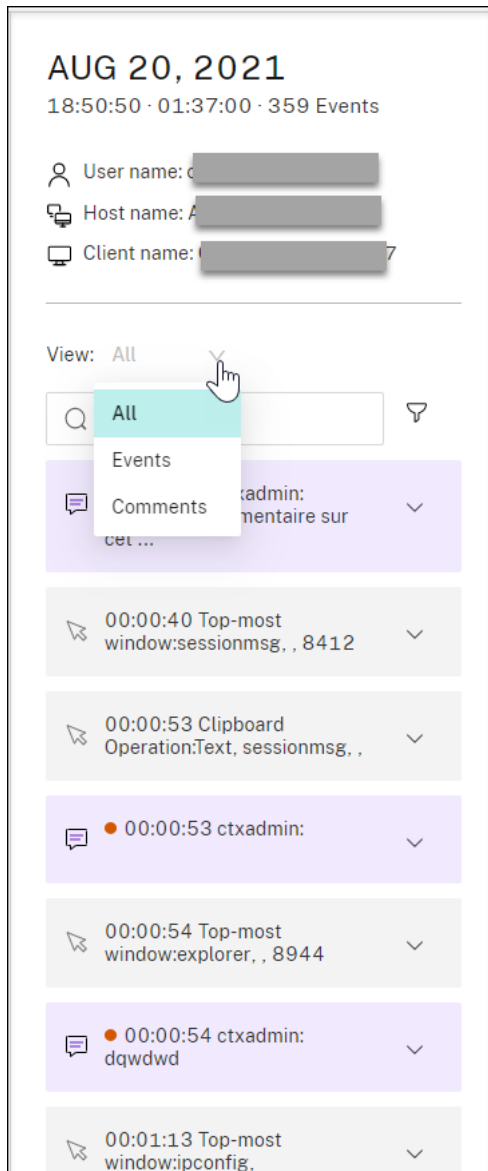

Comment on recordings

When a recorded session is being played, you can click the **Comments** player control to leave comments and set comment severities. Severities include Normal, Medium, and Severe. Severe and

Medium comments are indicated with red and orange dots, respectively. During session playback, you can view all comments about a recording. To delete a comment that you left, refresh your web-page, expand the comment, and then click **Delete**.

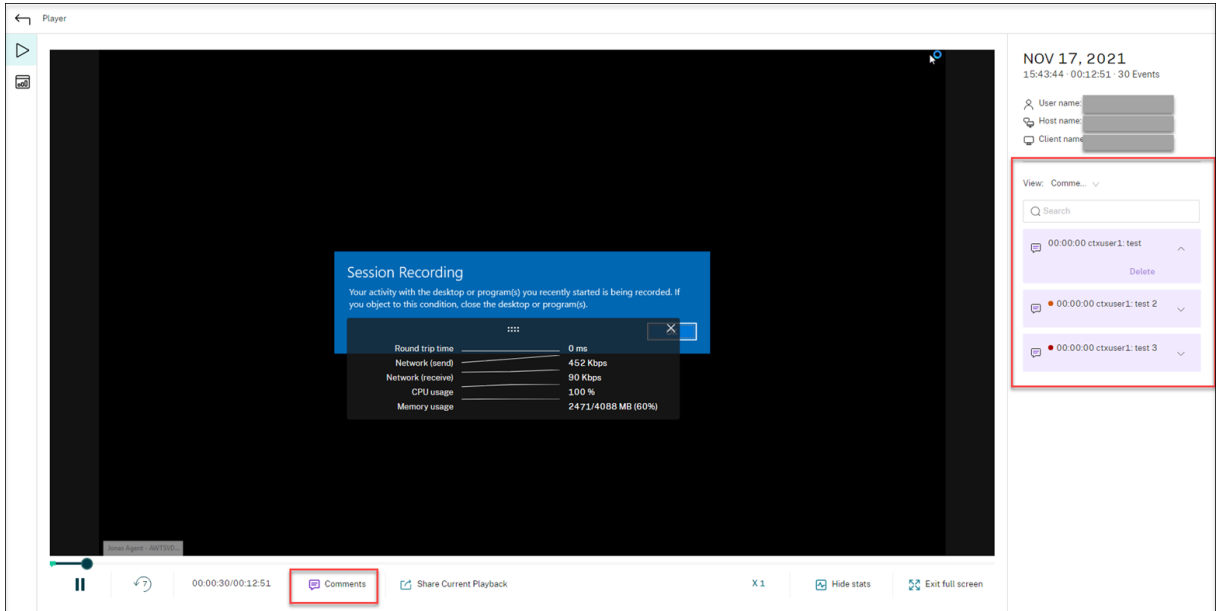

Clicking a comment lets you jump to the location where the comment was given. You can view all your comments on the **My comments** page.

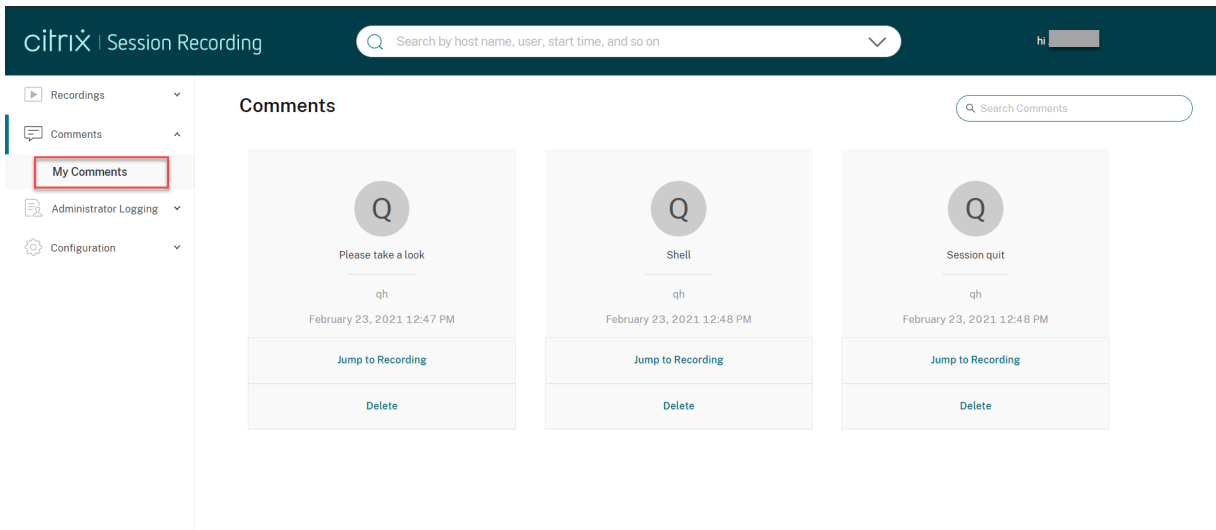

Note:

To make the comment feature work as expected, clear the **WebDAV Publishing** check box in the **Add Roles and Features** wizard of Server Manager on the Session Recording Server.

 Add Roles and Features Wizard

Select server roles

Before You Begin

Installation Type

Server Selection

Server Roles

Features

Confirmation

Results

Select one or more roles to install on the selected server.

Roles

- Hyper-V
- MultiPoint Services
- Network Policy and Access Services
- Print and Document Services
- Remote Access
- Remote Desktop Services
- Volume Activation Services
- Web Server (IIS) (27 of 43 installed)
 - Web Server (21 of 34 installed)
 - Common HTTP Features (5 of 6 installed)
 - Default Document (Installed)
 - Directory Browsing (Installed)
 - HTTP Errors (Installed)
 - Static Content (Installed)
 - HTTP Redirection (Installed)
 - WebDAV Publishing
 - Health and Diagnostics (4 of 6 installed)
 - Performance (Installed)
 - Security (3 of 9 installed)

< Previous Next >

Share recordings as links

December 3, 2024

Overview

You can share recordings as links so that other users can access the recordings directly, without the need to search among many recordings. You can share recordings as restricted and unrestricted links.

If you share a recording as a restricted link, only users who already have playback permission can view the recording using the link. If you share a recording as an unrestricted link, anyone in your AD domain can view the recording using the link.

To facilitate managing unrestricted links, Session Recording lets you:

- Set a validity period for each of the links.
- (Optional) Enter a justification when generating the links.
- Get an overview of which recordings have been shared as unrestricted links.
- View all unrestricted links of a specific recording.
- Know which users have accessed an unrestricted link.
- Revoke unrestricted links that haven't expired.
- Clear invalid links that have expired or revoked.

Note:

- To share recordings as unrestricted links and to manage unrestricted links, you must be assigned the **PrivilegedPlayer** role.
- To view a recording using an unrestricted link, users must enter a justification.

Share recordings as restricted links

To share recordings as restricted links, complete the following steps:

1. In the web player, open and play the recording that you want to share.
2. Click **Share** on the playback page of the recording. The **Generate recording link** dialog appears.

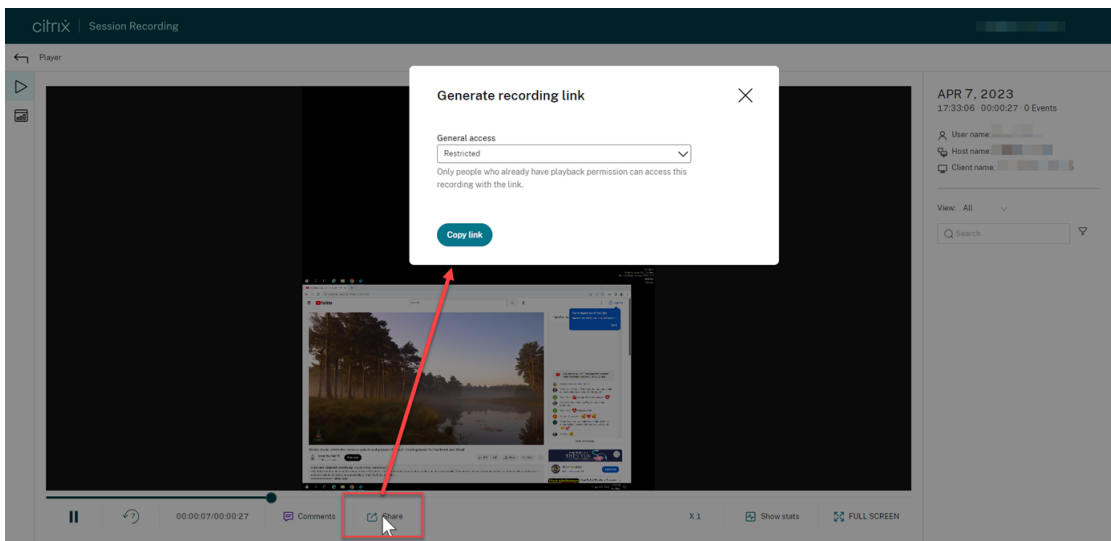

3. Select **Restricted** from the **General access** drop-down.

4. Click **Copy link**.

After you click **Copy link**, either of the following messages appears, indicating a successful or failed operation respectively:

- **The URL to the shared recording has been copied to the clipboard**
- **Sharing the recording URL failed**

5. Apply secure sharing at the server level.

To ensure secure sharing, set the following registry values under `HKEY_LOCAL_MACHINE\SOFTWARE\Citrix\SmartAuditor\Server`:

Registry value	Description	Default value	Remarks
LinkExpire	Time span beyond which a generated URL link expires. Counted as timeticks in the unit of 10 microseconds.	1,728,000,000,000 (The default value equals 2 days.)	-
LinkSalt	A security method to encrypt the preceding URL expiration time	Kk2od974	Change the default value to an arbitrary string that preferably ends with digits.

6. Share the generated URL link with users who already have playback permission.

Pasting the link in the address bar lets you jump to the location where the link was copied.

Share recordings as unrestricted links

Note:

To share recordings as unrestricted links, you must be assigned the **PrivilegedPlayer** role.

To share recordings as unrestricted links, complete the following steps:

1. In the web player, open and play the recording that you want to share.
2. Click **Share** on the playback page of the recording. The **Generate recording link** dialog appears.
3. Select **Unrestricted** from the **General access** drop-down.

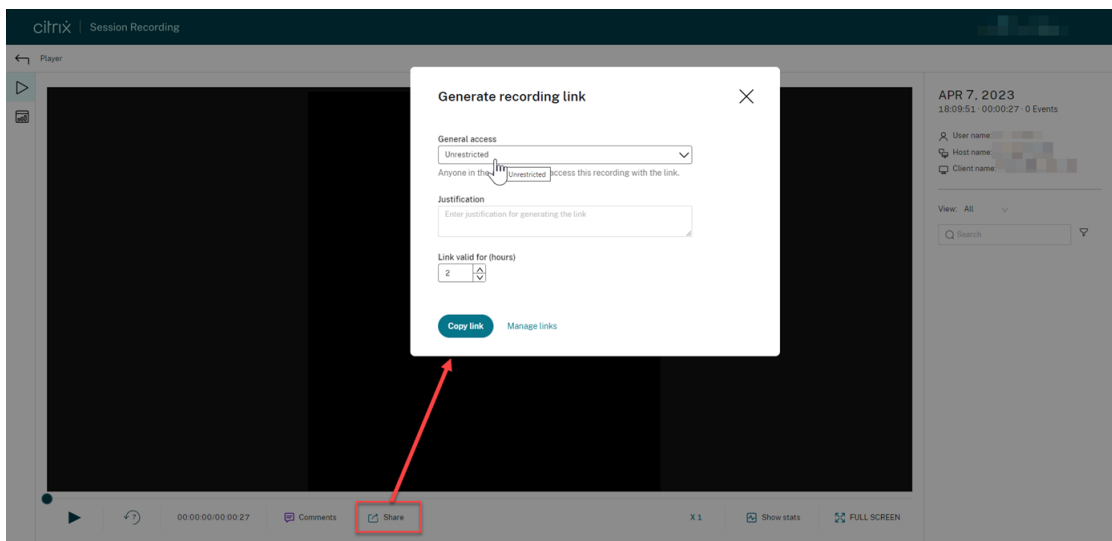

4. (Optional) Enter your justification for sharing the recording.
5. Set an expiration period for the link to be generated.
6. Click **Copy link**.

After you click **Copy link**, either of the following messages appears, indicating a successful or failed operation respectively:

- **The URL to the shared recording has been copied to the clipboard**
- **Sharing the recording URL failed**

7. Share the generated URL link with anyone in your AD domain.

Pasting the link in the address bar lets you jump to the location where the URL link was copied.

Note:

- To view a recording using an unrestricted link, users must enter a justification.
- The actions of generating and accessing unrestricted links are logged under the playback logging sector of [administrator logging](#).

Manage unrestricted links

Note:

To manage unrestricted links, you must be assigned the **PrivilegedPlayer** role.

View which recordings have been shared as unrestricted links

To get an overview of which recordings have been shared as unrestricted links, click **Manage Links** in the upper right corner of the **All Recordings** page.

Start Time	User	Host	Client	Events	Events Only	Recording Server	Duration	Action
April 6, 2023 10:38AM				0	False		00:00:27	
April 6, 2023 10:28AM				0	False		00:09:41	
April 6, 2023 10:17AM				0	False		00:11:45	
March 15, 2023 4:31PM				0	False		00:02:13	
March 15, 2023 4:07PM				0	False		00:03:28	
February 28, 2023 4:47PM				8	False		00:02:01	
February 28, 2023 9:59AM				0	False		00:04:50	
February 28, 2023 9:32AM				0	False		00:02:33	
February 28, 2023 9:31AM				0	False		00:00:53	
February 28, 2023 9:19AM				0	False		00:40:20	
February 28, 2023 6:33AM				0	False		02:46:00	
February 13, 2023 2:22PM				0	False		00:04:26	
February 13, 2023 2:11PM				0	True		00:10:52	

After you click **Manage Links**, only recordings that have been shared as unrestricted links are listed.

Start Time	User	Host	Client	Events	Events Only	Recording Server	Duration	Action
April 6, 2023 10:38AM			linlin_s_MacBook_Pro	0	False		00:00:27	6
April 6, 2023 10:17AM			linlin_s_MacBook_Pro	0	False		00:11:45	2
February 28, 2023 9:32AM			QHPLAY	0	False		00:02:33	1
November 30, 2022 3:01PM			APACPM2221	1	False		00:32:15	5
September 21, 2022 11:37AM			NKGWYUCHUNI01	0	False		00:14:59	1

View and manage unrestricted links of a specific recording

1. Open the **Manage unrestricted links** page.

Method 1: By clicking the link icon in the **Action** column on the **All Recordings** page

Start Time	User	Host	Client	Events	Events Only	Recording Server	Duration	Action
April 6, 2023 10:38AM			linlin_s_MacBook_Pro	0	False		00:00:27	6
April 6, 2023 10:17AM			linlin_s_MacBook_Pro	0	False		00:11:45	2
February 28, 2023 9:32AM			QHPLAY	0	False		00:02:33	1
November 30, 2022 3:01PM			APACPM2221	1	False		00:32:15	5
September 21, 2022 11:37AM			NKGWYUCHUNI01	0	False		00:14:59	1

Method 2: By clicking **Manage Links** in the **Generate recording link** dialog

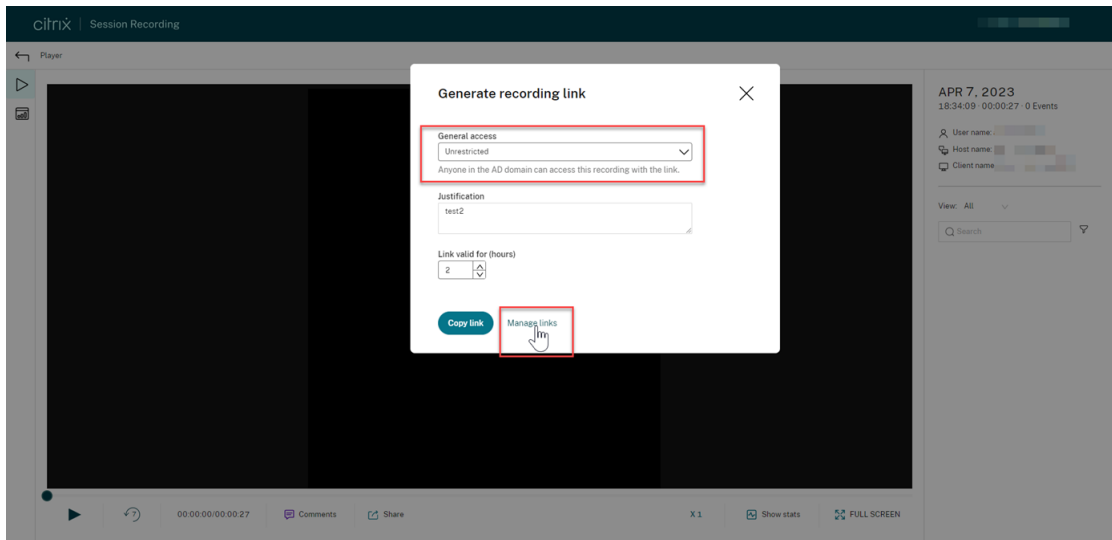

2. On the **Manage unrestricted links** page, expand each row to view details about the unrestricted links that are generated for the specific recording.

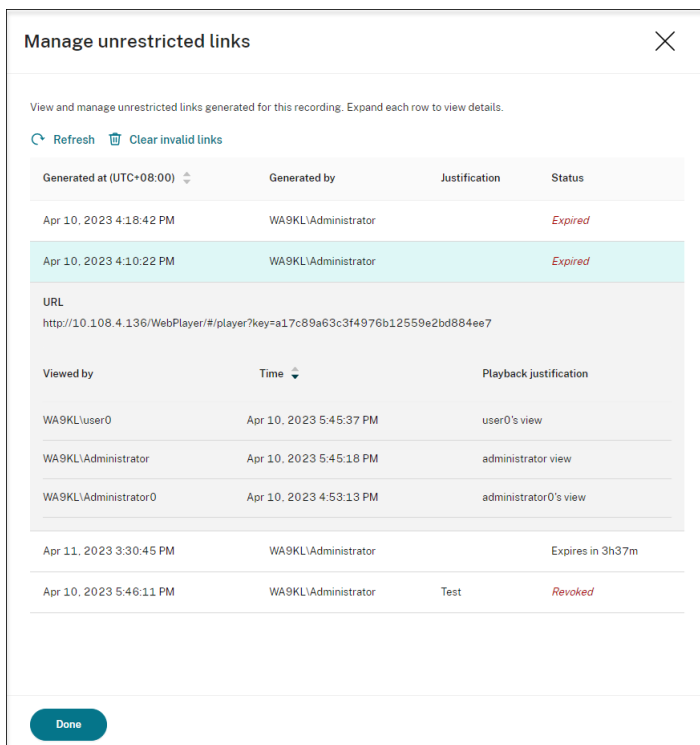

3. (Optional) To revoke a link, select it and then click **Revoke** that appears.

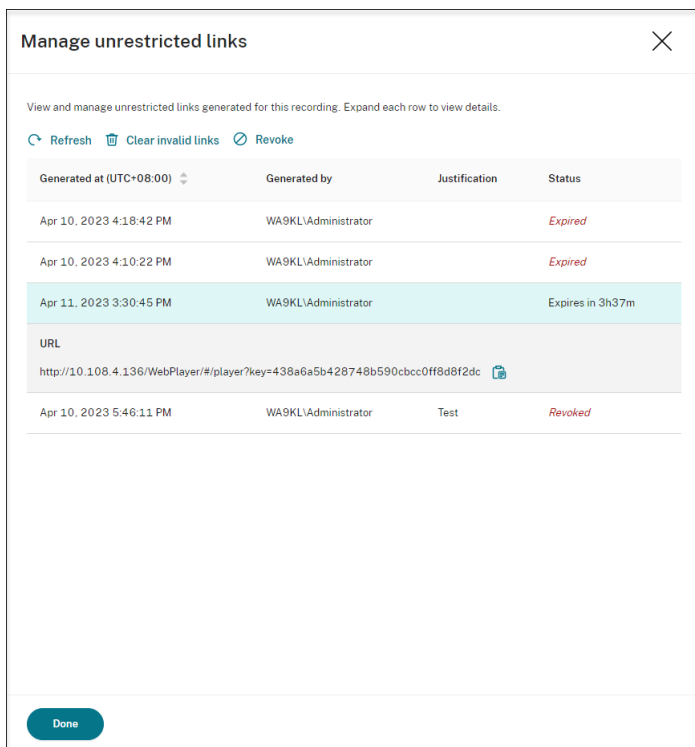

After you click **Revoke**, you are prompted to confirm the action.

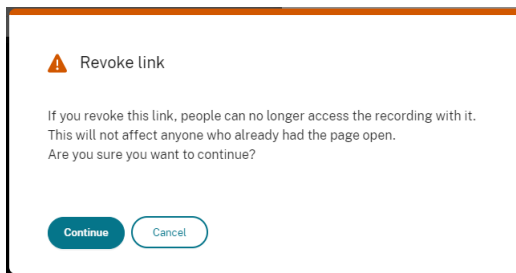

4. (Optional) To remove the links that have expired or revoked, click **Clear invalid links**.

View graphical event statistics for each recording

December 3, 2024

Event data visualization is available in the web player for each recording. It provides graphical event statistics for you to quickly comprehend the events inserted in recordings.

To view graphical event statistics, complete the following steps:

1. Open and play a recording.
2. In the upper left corner of the playback page, click the statistics icon.

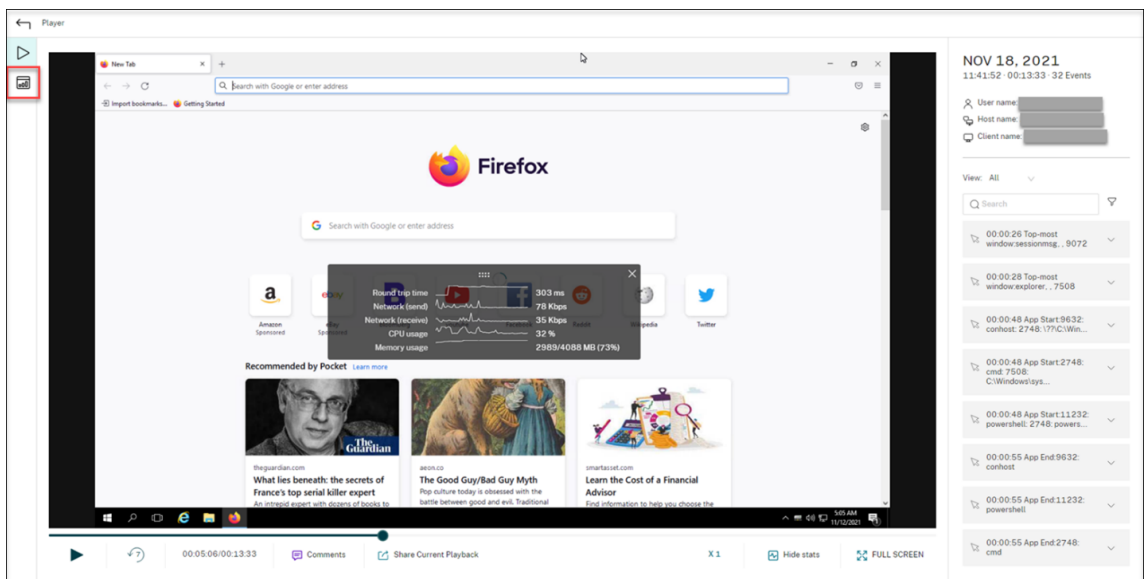

3. Switch between the **Screen time**, **File transfers**, **Commands**, and **Events** tabs to view statistics from different perspectives.

- **Screen time**

The **Screen time** tab lets you know the cumulative time an application window is in focus (active window).

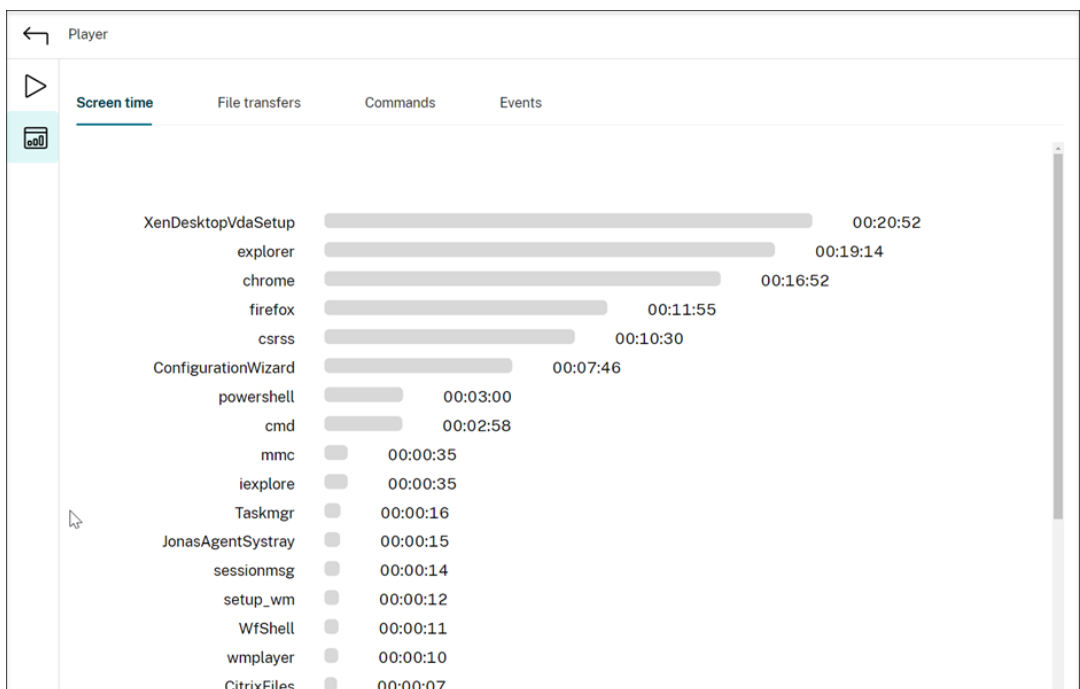

There is a horizontal time bar next to each application. Click the bar to view the start time and duration each time an application becomes and stays in focus, respectively. You can narrow down your search range by specifying a duration range other than the default **All**

option. For example:

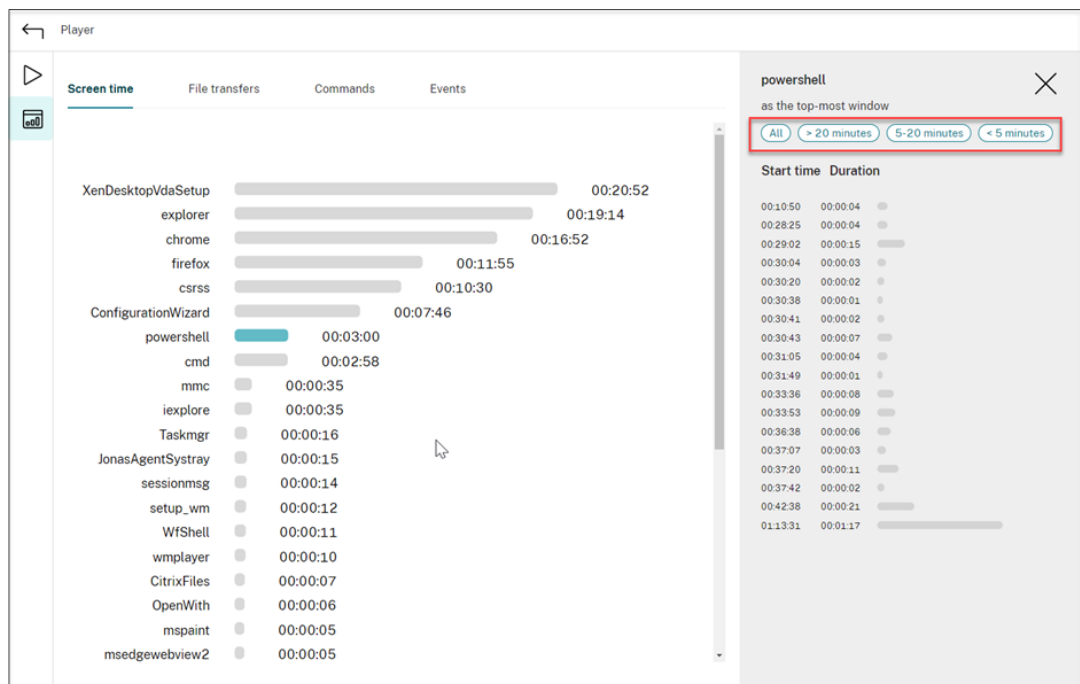

- **File transfers**

The **File transfers** tab provides graphical statistics about bidirectional file transfers between the VDA hosting the recorded session and the client device where the session runs. You can customize the visualization by using the following settings:

- Time granularity: **Per 1 minute**, **Per 10 minutes**, **Per hour**
- File transfer destination: **All transfers**, **Transfer from host to client**, **Transfer from client to host**
- Number or size (Bytes or MB) of transferred files

The X axis represents the absolute time in the 24-hour system.

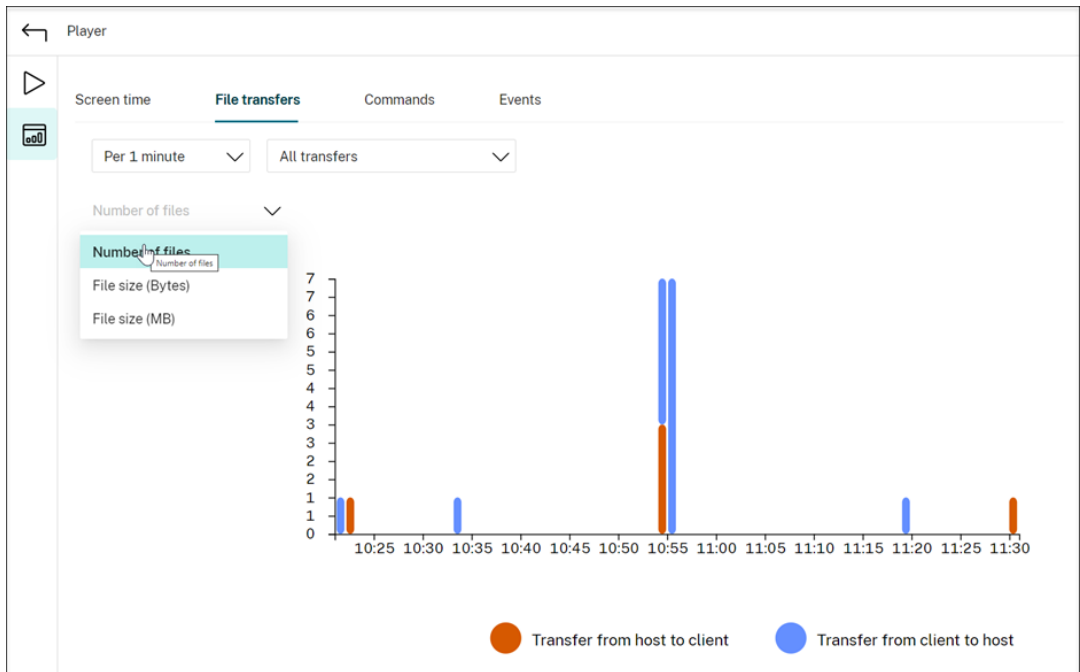

• **Commands**

The **Commands** tab shows CMD and PowerShell commands that are run during the recorded session. You can customize the data display by typing your custom search in **Custom search** or selecting a saved search from **Saved search**. The “OR” logical operator is used to compute the final action.

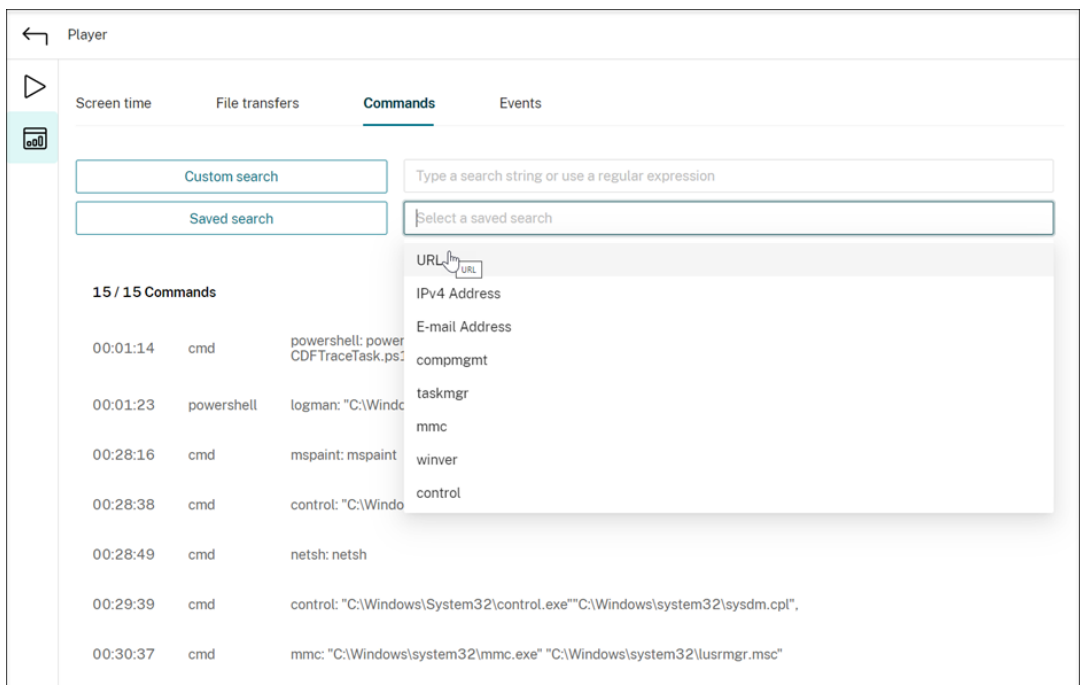

• **Events**

The **Events** tab shows the proportions and numbers of all types of events in the recorded session.

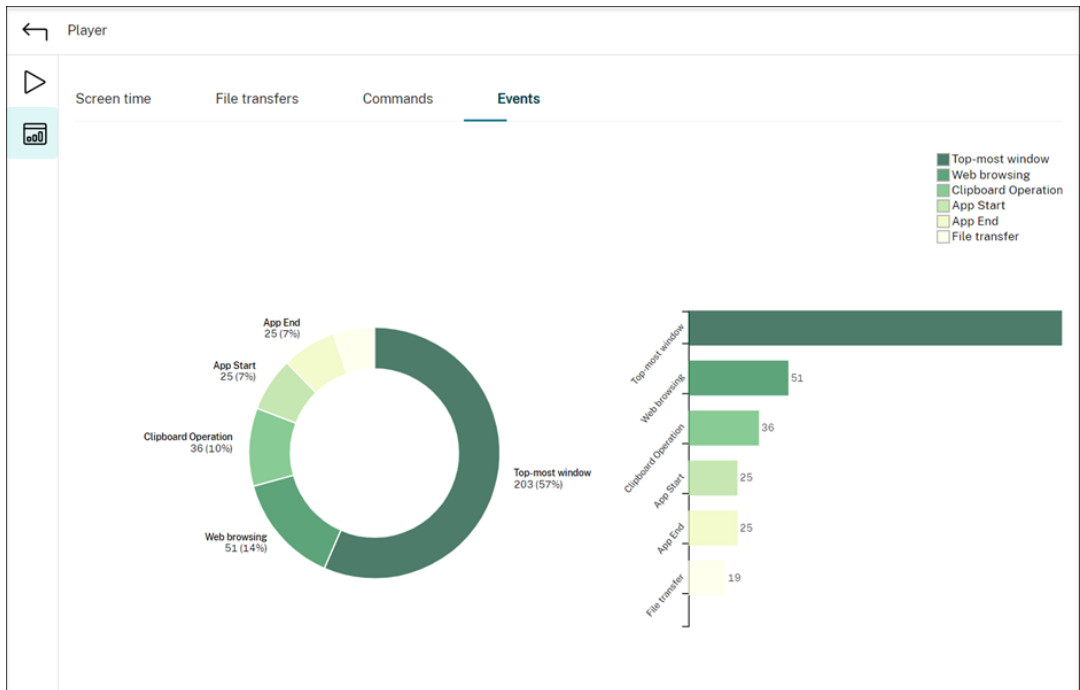

View data points related to each recorded session

December 3, 2024

During playback, you can click the **Show stats** control to view, on an overlay, the following data points related to the recorded session:

- Round trip time
- Network (send)
- Network (receive)
- CPU usage
- Memory usage

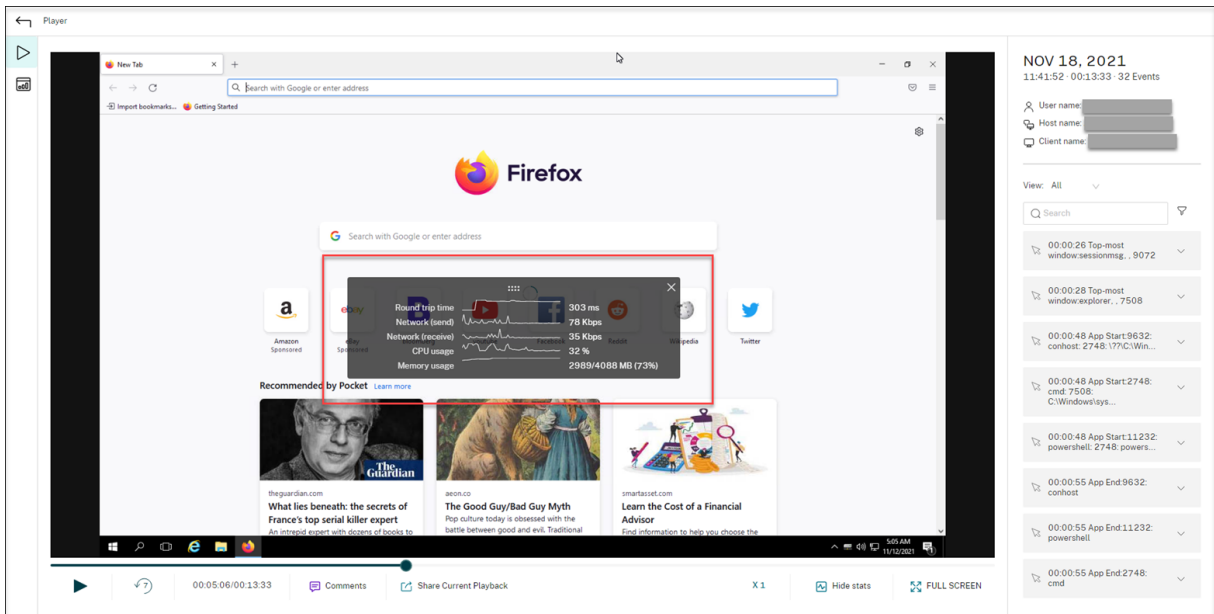

Note:

- Session Recording collects round-trip time every 15 seconds and the rest of the data points every second.
- Theoretically, Session Recording refreshes data on round-trip time every five seconds. However, round trip time data actually refreshes every 15 seconds because of the collection cycle.
- Session recording refreshes the rest of the data points every 5 seconds and presents their average values on the overlay.

The overlay is semi-transparent. You can relocate and hide it.

- To relocate the overlay, hover your mouse over the eight dots and then do a drag and drop.
- To hide the overlay, click **Hide stats**.

You can enable the overlay by selecting **Log performance data** when creating your event detection policy. For more information, see [Configure event detection policies](#).

Manage recordings

December 4, 2024

ICA log database (ICLDB) is a database command-line utility used to manipulate the session recording database records. This utility is installed, during the Session Recording installation, to the `<Session Recording Server installation path>\Bin` folder on the server hosting the Session Recording server.

Note:

If you want to use ICLDB to manage session recording files stored in Azure file shares, run the `SsRecUtils.exe -MountAzureFiles` command. `SsRecUtils.exe` and `ICLDB` are in the same folder.

Quick reference chart

The following table lists the commands and options that are available for the ICLDB utility. Type the commands using the following format:

```
ICLDB [VERSION | LOCATE | DORMANT | IMPORT | ARCHIVE | REMOVE | REMOVEALL] command-options [/L] [/F] [/S] [/?]
```

Note:

More extensive instructions are available in the help associated with the utility. To access the help, from a command prompt, type the `\Program Files\Citrix\SessionRecording\Server\Bin` folder, and type `iclodb /?`. To access help for specific commands, type `iclodb <specific command> /?`.

Command	Description
ARCHIVE	<p>Archives the session recording files that you specify. You can specify a target session recording file to archive by using the FILEID parameter. You can also specify target session recording files by using the RETENTION parameter and the FILTER or RULES parameter. In the second case, the RETENTION parameter is mandatory. It lets you manipulate session recording files older than the retention period specified. A valid retention period is 2 days at least. Therefore, set RETENTION to 2 or a greater value that suits your needs. The FILTER and RULES parameters are optional. The FILTER parameter lets you filter file paths by using the * and ? wildcards. The RULES parameter sets advanced filters by combining multiple filters strictly in accordance with the <code>/RULES:FIELD-In-["CONDITION"], "CONDITION"];FIELD-NotIn-["CONDITION"], "CONDITION"]; format</code>. For more information, see The RULES parameter for ICLDB ARCHIVE and ICLDB REMOVE commands following this table. The RULES parameter and the FILTER parameter cannot be used together. If you add the FILTER or RULES parameter, only session recording files meeting both RETENTION and FILTER or RULES are manipulated. You can archive both recordings and events in the recordings. The events are archived in the ArchivedEvent database table. Example ICLDB ARCHIVE command:</p> <pre>ICLDB ARCHIVE /RETENTION:<days> [/LISTFILES] [/MOVETO:<dir>] [/ NOTE:<note>] [/FILTER:<file path filter>] [/RULES:<advanced filters>] [/L] [/F] [/S] [/?]</pre>

Command	Description
DORMANT	<p>Displays or counts the live recording files that are considered dormant or unresponsive. A live recording is considered unresponsive or dormant when no new data is written to the recording file after a specified period of time has elapsed. You can specify a target session recording file by using the FILEID parameter. You can also check whether session recording files are becoming dormant for the entire database, or only recordings made within the specified number of days, hours, or minutes. Among the time parameters (DAYS, HOURS, and MINUTES), only one can be specified at a time. You can manually close unresponsive or dormant live recordings by appending the CLOSEFILES parameter. You can also set a time threshold on the Storage tab of Session Recording Server Properties to close unresponsive or dormant live recordings automatically when the threshold is exceeded. For more information, see Close unresponsive or dormant live recordings later in this article.</p>

Command	Description
<code>IMPORT</code>	<p>Imports session recording files to the Session Recording database. Use this command to rebuild the database if you lose database records. Also, use this command to merge databases (if you have two databases, you can import the files from one of the databases). The 2303 release introduces the <code>RELOCATE</code> parameter to the IMPORT command. Without the <code>RELOCATE</code> parameter, the IMPORT command parses session recording files in their entirety, which takes time. With the <code>RELOCATE</code> parameter, the IMPORT command simply locates the database records of session recording files and updates their file paths directly. Example ICLDB <code>IMPORT</code> command:</p> <pre>ICLDB IMPORT [/LISTFILES] [/RECURSIVE] [/RELOCATE] [/L] [/F] [/S] [/?] [<file>] [<directory>]</pre>
<code>LOCATE</code>	<p>Locates and displays the full path to a session recording file using the file ID as the criteria. Use this command when you are looking for the storage location of a session recording file. It is also one way to verify if the database is up-to-date with a specific file. Example ICLDB <code>LOCATE</code> command: <code>ICLDB LOCATE /FILEID :<id> [/L] [/F] [/S] [/?]</code></p>

Command	Description
REMOVE	<p>Removes the references to session recording files from the database. Use this command (with caution) to clean up the database. You can also remove the associated physical files. When using the REMOVE command, you can either specify a target session recording file by using the FILEID parameter or specify target session recording files using the RETENTION parameter and the FILTER or RULES parameter. In the second case, the RETENTION parameter is mandatory. It lets you manipulate session recording files older than the retention period specified. A valid retention period is 2 days at least. Therefore, set RETENTION to 2 or a greater value that suits your needs. The FILTER and RULES parameters are optional. The FILTER parameter lets you filter file paths by using the * and ? wildcards. The RULES parameter sets advanced filters by combining multiple filters strictly in accordance with the <code>/RULES:FIELD-In-["CONDITION", "CONDITION"];FIELD-NotIn-["CONDITION", "CONDITION"];</code> format. For more information, see The RULES parameter for ICLDB ARCHIVE and ICLDB REMOVE commands following this table. The RULES parameter and the FILTER parameter cannot be used together. If you add the FILTER or RULES parameter, only session recording files meeting both RETENTION and FILTER or RULES are manipulated. Example ICLDB REMOVE command: <code>ICLDB REMOVE /RETENTION:<days> [/LISTFILES] [/DELETEFILES] [/FILTER:<file path filter>] [/RULES:<advanced filters>] [/L] [/F] [/S] [/?]</code></p>

Command	Description
REMOVEALL	Removes all references to session recording files from the Session Recording database and returns the database to its original state. The actual physical files are not deleted; however, you cannot search for these files in the Session Recording player. Use this command (with caution) to clean up the database. Deleted references can be reversed only by restoring from your backup.
VERSION	Displays the Session Recording database schema version.
/L	Logs the results and errors to the Windows event log.
/F	Forces the command to run without prompts.
/S	Suppresses the copyright message.
/?	Displays help for the commands.

The RULES parameter for ICLDB ARCHIVE and ICLDB REMOVE commands

The RULES parameter sets advanced filters by combining multiple filters strictly in accordance with the `/RULES:FIELD-In-["CONDITION", "CONDITION"];FIELD-NotIn-["CONDITION", "CONDITION"];` format, where:

- “**FIELD**”sets a filter with a field, which can be “**path**”, “**user**”, “**group**”, “**deliverygroup**”, “**application**”, “**server**”, “**client**”, or any other column in the database table called **dbo.ICLFile**.
- “**In**”means that at least one of the filter conditions in the brackets must be met for a recording file to be an operation object.
- “**NotIn**”means that recording files that meet any of the filter conditions in the brackets are excluded from the operation.
- “**CONDITION**”sets a filter condition with a record (or row) in the database table called **dbo.ICLFile**.
- User and group records must be entered in the format of `<domain>.<name>`.
- Path records can be filtered by using Windows wildcards.
- You must enclose each “**CONDITION**”item in double quotes (") and separate two “**CONDITION**”items with a comma (,).

- Do not add spaces when entering “**CONDITION**” items unless a “**CONDITION**” item itself contains spaces.
- If a “**CONDITION**” item contains one or more commas, enclose the “**CONDITION**” item in double quotes that are followed by escaped double quotes `""""`.
- Multiple filters can be used in various combinations. End each filter with a semicolon (;).
- The “AND” logical operator is used to compute the multiple filters. There is no limit to the number of filters, but the total length of RULES must not exceed 2,048 bytes.

Examples:

- `/RULES:group-In-["BUILTIN.Guests"];`
- `/RULES:path-In-["S:\SessionRecordings\2023*"];group-NotIn-["Mydomain.Suspicious","Mydomain.Persistence"];`
- `/RULES:deliverygroup-In-["RdsDesktopAndAppGroup"];user-In-["Mydomain.AdminA","""Mydomain.Admin,,B"""];`
- `/RULES:EndReasonID-In-["1","2"];`

Archive session recording files

To maintain an adequate level of spare disk capacity in the recording storage locations, archive session recording files regularly. Depending on the amount of available disk space and typical size of recording files, archiving intervals differ. Session recording files must be older than two days from the start date before a session recording file can be archived. This rule is to prevent any live recordings from being archived before they become complete.

Two methods are available when you archive session recordings. The database record for a recording file can be updated to have a status of archived while the file remains in the recording storage location. This method can be used to reduce the search results in the player. The other method is to update the database record for a recording file to the archived status and move the file from the recording storage location to another location for backup to alternative media. When moving session recording files, the ICLDB utility moves them to the specified directory where the original file folder structure of **year/month/day** no longer exists.

The session recording record in the Session Recording database contains two fields associated with archiving—the archive time and archive note. The archive time represents the current date and time that a recording was archived. The archive note is an optional text note that can be added during archiving. The two fields indicate that a recording has been archived and the time of archiving.

In the Session Recording player, archived session recordings show a status of Archived and the date and time of archiving. Session recordings that have been archived might still be played if the files have not been moved. If a session recording file was moved during archiving, a file not found error is

displayed. The session recording file must be restored before the session can be played. To restore a session recording file, provide the File ID and Archive Time of the recording file. Restoring archived files is discussed further in the following [Restore session recording files](#) section.

The **ARCHIVE** command of the ICLDB utility has several parameters that are described as follows:

- **/FILEID:<id>** - Lets you specify a target session recording file. You can check the ID of a session recording file in the Session Recording player (Windows). A recording file name can also be used as the file ID.
- **/RETENTION:<days>** - The retention period in days for session recordings. Recordings older than the number of days specified are marked as archived in the Session Recording database. The retention period must be an integer number greater than or equal to 2 days.
- **/FILTER:<filter>**: Lets you filter file paths by using the * and ? wildcards. The FILTER parameter is optional. If you add the FILTER parameter, only those session recording files meeting both RETENTION and FILTER are archived.
- **/RULES:<advanced filters>**: Sets advanced filters by combining multiple filters strictly in accordance with the `/RULES:FIELD-In-["CONDITION", "CONDITION"];FIELD-NotIn-["CONDITION", "CONDITION"];` format. The RULES parameter and the FILTER parameter cannot be used together. For more information, see the preceding The RULES parameter for ICLDB ARCHIVE and ICLDB REMOVE commands section in this article.
- **/LISTFILES** - Lists the full path and file name of session recording files as they are being archived. This parameter is optional.
- **/MOVETO:<directory>** - The directory to which you physically move archived session recording files. The specified directory must exist. This parameter is optional. If no directory is specified, the files remain in their original storage location.
- **/NOTE:<note>** - A text note that is added to the database record for each session recording archived. Ensure that the note is enclosed with double quotes. This parameter is optional.
- **/L** - Logs the results and errors to the Windows event log of the number of session recording files archived. This parameter is optional.
- **/F** - Forces the archive command to run without prompts. This parameter is optional.

To archive session recordings in the Session Recording database and physically move session recording files

1. Log on to the server where the Session Recording server is installed as a local administrator.
2. Start a command prompt.

3. Change from the current working directory to the Bin directory of the Session Recording server installation path (<Session Recording server Installation Path>\Bin).
4. Run the `ICLDB ARCHIVE /RETENTION:<days> [/LISTFILES] [/MOVETO:<dir>] [/NOTE:<note>] [/FILTER:<file path filter>] [/RULES:<advanced filters>] [/L] [/F] [/S] [/?] command. The parameters in brackets are optional. Remove the brackets when running the command. The RULES parameter and the FILTER parameter cannot be used together. days is the retention period for session recording files, directory is the directory where archived session recording files are moved to, and note is the text note that is added to the database record for each session recording file being archived. Enter Y to confirm the archive.`

To only archive session recordings in the Session Recording database

1. Log on to the server where the Session Recording server is installed as a local administrator.
2. Start a command prompt.
3. Change from the current working directory to the Bin directory of the Session Recording server installation path (<Session Recording server installation path>\Bin).
4. Run the `ICLDB ARCHIVE /RETENTION:<days> [/LISTFILES] [/NOTE:<note>] [/FILTER:<file path filter>] [/RULES:<advanced filters>] [/L] [/F] [/S] [/?] command. The parameters in brackets are optional. Remove the brackets when running the command. The RULES parameter and the FILTER parameter cannot be used together. days is the retention period for session recordings and note is the text note that is added to the database record for each session recording being archived. Enter Y to confirm the archive.`

Restore session recording files

To view a recording file archived in the Session Recording database and moved from the recording storage location, restore it. Archived session recordings that were not moved from the recording storage location during archiving are still accessible in the player.

Two methods are available for restoring session recording files that have been moved. Copy the required session recording file to the restore directory for archived files. Or, import the required session recording file back to the Session Recording database by using the ICLDB utility. We recommend the first method for restoring archived session recording files. Remove archived files copied to the restore directory for archived files when you no longer need them.

The Session Recording Broker uses the **Restore directory for archived files** when a session recording file is not found in its original storage location. This case occurs when the player requests a session

recording file for playback. The Session Recording Broker first attempts to find the session recording file in the original storage location. If the file is not found in the original storage location, the Session Recording Broker then checks the **Restore directory for archived files**. If the file is present in the restore directory, the Session Recording Broker sends the file to the player for playback. If the file is not found, the Session Recording Broker sends a file not found error to the player.

Importing an archived recording file updates the Session Recording database with the session recording information from the file, including a new storage path. Importing an archived session recording file doesn't move the file back to the original storage location when the session was recorded.

Note: An imported session recording file has the archive time and archive note cleared in the Session Recording database. The next time the **ICLDB ARCHIVE** command is run, the imported session recording file might become archived again.

The **ICLDB IMPORT** command is useful to import a large number of archived recording files. It can repair or update incorrect and missing session recording data in the Session Recording database. It is also useful to move session recording files from one storage location to another on the Session Recording server. You can use the **ICLDB IMPORT** command to repopulate the Session Recording database with session recordings after running the **ICLDB REMOVEALL** command.

The **IMPORT** command of the ICLDB utility has several parameters that you can use for restoring archived recording files:

- **/LISTFILES** –Lists the full path and file name of session recording files while they are being imported. This parameter is optional.
- **/RECURSIVE** –Searches all subdirectories for session recording files. This parameter is optional.
- **/RELOCATE** –Without the RELOCATE parameter, the IMPORT command parses session recording files in their entirety, which takes time. With the RELOCATE parameter, the IMPORT command simply locates the database records of session recording files and updates their file paths directly.
- **/L** –Logs the results and errors to the Windows event log the number of session recording files imported. This parameter is optional.
- **/F** –Forces the IMPORT command to run without prompts. This parameter is optional.

Note:

The IMPORT command of the ICLDB utility also provides an optional parameter, RELOCATE, that you can use for relocating recording files. For more information, see the Relocate session recording files section in this article.

Restore session recording files by using the restore directory for archived files

1. Log on as a local administrator to the server where the Session Recording server is installed.

2. In Session Recording Player Properties, determine the File ID and Archive Time of the archived session recording file.
3. Locate the session recording file in your backups using the File ID specified in Session Recording Player Properties. Each session recording has a file name of `i_<FileID>.icl`, where FileID is the ID of the session recording file.
4. Copy the session recording file from your backup to the restore directory for archived files. To determine the restore directory for archived files:
 - a) From the **Start** menu, choose **Start > All Programs > Citrix > Session Recording Server Properties**.
 - b) In **Session Recording Server Properties**, select the **Storage** tab. The current restore directory appears in the **Restore directory for archived files** field.

Restore session recording files by using the ICLDB IMPORT command

1. Log on as a local administrator to the server where the Session Recording server is installed.
2. Start a command prompt.
3. Change from the current working directory to the Bin directory of the Session Recording server installation path (`<Session Recording server installation path>\Bin`).
4. Either:
 - Run the `ICLDB IMPORT /LISTFILES /RECURSIVE /L <directory>` command where **directory** is the name of one or more directories, separated by a space containing session recording files. Enter **Y** to confirm the import.
 - Run the `ICLDB IMPORT /LISTFILES /L <file>` command where **file** is the name of one or more session recording files, separated by a space. Wildcards might be used to specify session recording files. Enter **Y** to confirm the import.

Relocate session recording files

You can move session recording files to different storage paths for load balancing or other purposes. To ensure that the files can still be played, you must update their new paths to the Session Recording database. To do so, use the **ICLDB IMPORT** command. To accelerate the import process, append the **RELOCATE** parameter to the **ICLDB IMPORT** command.

Note:

The **RELOCATE** parameter is optional. Without the **RELOCATE** parameter, the **ICLDB IMPORT** command parses session recording files in their entirety, which takes time. With the **RELOCATE** pa-

parameter, the ICLDB IMPORT command simply locates the database records of session recording files and updates their file paths directly.

The following steps illustrate how to use the RELOCATE parameter to update new file paths to the Session Recording database.

1. Move session recording files to different storage paths as needed.
2. Log on as a local administrator to the server where the Session Recording server is installed.
3. Start a command prompt.
4. Change from the current working directory to the Bin directory of the Session Recording server installation path (<Session Recording server installation path>\Bin).
5. Either:
 - Run the `ICLDB IMPORT /LISTFILES /RECURSIVE /RELOCATE /L <directory>` command where **directory** is the name of one or more directories, separated by a space containing session recording files. Enter **Y** to confirm the import.
 - Run the `ICLDB IMPORT /LISTFILES /RELOCATE /L <file>` command where **file** is the name of one or more session recording files, separated by a space. Wildcards might be used to specify session recording files. Enter **Y** to confirm the import.

Note:

- The RELOCATE parameter assumes that there are already records of the session recording files in the Session Recording database.
- The session recording files must be playable before being moved. Otherwise, the RELOCATE parameter does not help.
- The new storage paths of the session recording files must be recognizable by the Session Recording server. You can try them on the **Storage** tab of **Session Recording Server Properties**.

Close unresponsive or dormant live recordings

By default, a live recording is considered unresponsive or dormant if no new data was written to the recording file for 24 hours. You can configure this time threshold on the **Storage** tab of **Session Recording Server Properties** to close unresponsive or dormant live recordings automatically when this threshold is exceeded. The minimum value that you can set is 12 (hours).

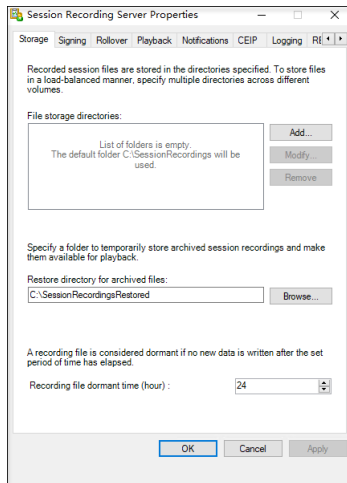

You can also manually close unresponsive or dormant live recordings by using the **ICLDB DORMANT** command, for example:

```
1 ICLDB DORMANT [/DAYS:<days> | /HOURS:<hours> | /MINUTES:<minutes> | /  
FILEID:<id>] [/LISTFILES] [/CLOSEFILES] [/L] [/F] [/S] [/?]
```

The FILEID parameter lets you specify a target session recording file and the CLOSEFILES parameter lets you manually close unresponsive or dormant live recordings that you specify.

Tip:

You can check the ID of a session recording file in the Session Recording player (Windows). A recording file name can also be used as the file ID.

Manage and query administrator logging

December 3, 2024

Query the administrator logging data

Requirements

- An administrator assigned to both the **LoggingReader** and the **Player** roles can view administrator logging. To assign users to the roles, go to the Session Recording Authorization Console.
- The administrator logging page is integrated with the web player. The web player must be installed for querying administrator logging. Otherwise, 404 (page not found) errors can occur.

- The language set for the web player browser must match the language you selected when you installed the Session Recording Administration components.
- Ensure that your SessionRecordingLoggingWebApplication site in IIS and the web player have the same SSL settings. Otherwise, 403 errors occur when you request to access the administrator logging data.

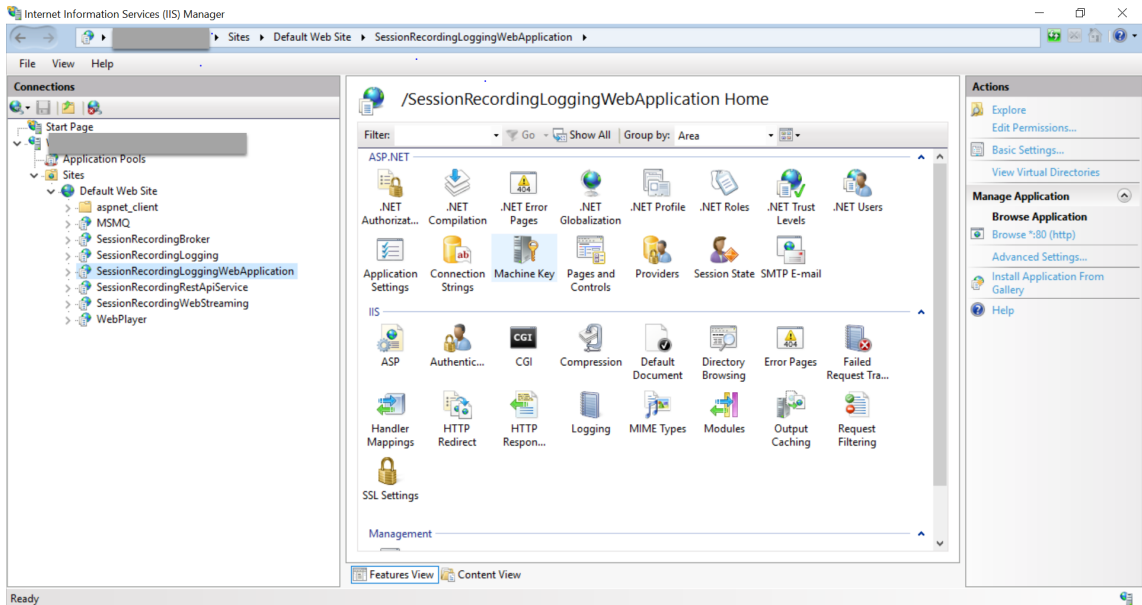

Steps

You can query administrator logging data about a Session Recording server both from the machine that hosts the server and from other machines:

On the machine hosting the target Session Recording server

1. From the **Start** menu, choose **Session Recording Administrator Logging**.
2. Type the credentials of a **LoggingReader** user.

The administrator logging webpage integrated with the web player appears.

ID	Logging Time	Task Category	Component Affected	Action Details	Action Executed By
257	11/9/2022 6:31 PM	Server configuration change	Session Recording Server	Report setting change ...	XF485/Administrator
204	11/4/2022 9:54 AM	Server configuration change	Session Recording Server	Report setting change ...	XF485/Administrator
202	11/3/2022 5:15 PM	Server configuration change	Session Recording Server	Report setting change ...	XF485/Administrator
174	11/3/2022 2:46 PM	Server configuration change	Session Recording Server	NotifyMessageDefault>Your activity with the desktop or p...	XF485/Administrator
165	11/2/2022 5:46 PM	Policy change	Session Recording Policy Console	Action = SetActivePolicyDocument ...	XF485/Administrator
160	10/31/2022 3:22 PM	Policy change	Session Recording Policy Console	Action = SetActivePolicyDocument ...	XF485/Administrator
148	10/24/2022 8:52 AM	Server configuration change	Session Recording Server	NotifyMessageDefault>Your activity with the desktop or p...	XF485/Administrator
146	10/24/2022 8:42 AM	Log reading	Session Recording Server	UserName = XF485/Administrator...	XF485/Administrator
145	10/24/2022 8:41 AM	Log reading	Session Recording Server	UserName = XF485/Administrator...	XF485/Administrator
144	10/24/2022 8:41 AM	Log reading	Session Recording Server	UserName = XF485/Administrator...	XF485/Administrator

On other machines

- Open a web browser and visit the webpage for administrator logging.
 - For HTTPS:** <https://servername/WebPlayer/#/logging/config> and <https://servername/WebPlayer/#/logging/record>, where **servername** is the name of the machine hosting the Session Recording server.
 - For HTTP:** <http://servername/WebPlayer/#/logging/config> and <http://servername/WebPlayer/#/logging/record>, where **servername** is the name of the machine hosting the Session Recording server.
- Type the credentials of a **LoggingReader** user.

Logging data overview

Administrator logging data consists of:

- Configuration logging
- Recording reason logging
- Playback logging.

Recordings	ID	Logging Time	Task Category	Component Affected	Action Details	Action Executed By
	257	11/9/2022 6:31 PM	Server configuration change	Session Recording Server	Report setting change ...	XF4BS/Administrator
Administrator Logging	204	11/4/2022 9:54 AM	Server configuration change	Session Recording Server	Report setting change ...	XF4BS/Administrator
Configuration Logging	202	11/3/2022 5:15 PM	Server configuration change	Session Recording Server	Report setting change ...	XF4BS/Administrator
Record Reason Logging	174	11/3/2022 2:46 PM	Server configuration change	Session Recording Server	NotifyMessageDefault>Your activity with the desktop or p...	XF4BS/Administrator
Playback Logging	165	11/2/2022 5:46 PM	Policy change	Session Recording Policy Console	Action = SetActivePolicyDocument ...	XF4BS/Administrator
Configuration	160	10/31/2022 3:22 PM	Policy change	Session Recording Policy Console	Action = SetActivePolicyDocument ...	XF4BS/Administrator
	148	10/24/2022 8:52 AM	Server configuration change	Session Recording Server	NotifyMessageDefault>Your activity with the desktop or p...	XF4BS/Administrator
	146	10/24/2022 8:42 AM	Log reading	Session Recording Server	UserName = XF4BS/Administrator...	XF4BS/Administrator
	145	10/24/2022 8:41 AM	Log reading	Session Recording Server	UserName = XF4BS/Administrator...	XF4BS/Administrator
	144	10/24/2022 8:41 AM	Log reading	Session Recording Server	UserName = XF4BS/Administrator...	XF4BS/Administrator

Configuration logging

This part logs the following administrator activities:

- **Policy change** - Changes to policies on the Session Recording policy console or Citrix Director
- **Server configuration change** - Changes in Session Recording Server Properties
- **Log reading** - Unauthorized attempts to access the administrator logging data

To log administrator activities, enable administrator logging on your Session Recording servers. For more information, see [Disable or enable administrator logging](#). To enhance security, you can also [configure an administrator logging service account](#).

Tip:

You can enable administrator logging both through the Session Recording service and through Session Recording Server Properties.

Recordings	ID	Logging Time	Task Category	Component Affected	Action Details	Action Executed By
	84	11/8/2022 5:00 PM	Recording reason	Session Recording Agent	Applications = BVT_DB/Desktop/###Desktop...	XF4BS/Administrator
Administrator Logging	83	11/8/2022 3:55 PM	Recording reason	Session Recording Agent	Applications = BVT_DB/Desktop/###Desktop...	XF4BS/Administrator
Configuration Logging	82	11/8/2022 2:50 PM	Recording reason	Session Recording Agent	Applications = BVT_DB/Desktop/###Desktop...	XF4BS/Administrator
Record Reason Logging	81	11/8/2022 1:45 PM	Recording reason	Session Recording Agent	Applications = BVT_DB/Desktop/###Desktop...	XF4BS/Administrator
Configuration	80	11/8/2022 12:40 PM	Recording reason	Session Recording Agent	Applications = BVT_DB/Desktop/###Desktop...	XF4BS/Administrator
	79	11/8/2022 11:35 AM	Recording reason	Session Recording Agent	Applications = BVT_DB/Desktop/###Desktop...	XF4BS/Administrator
	78	11/8/2022 10:30 AM	Recording reason	Session Recording Agent	Applications = BVT_DB/Desktop/###Desktop...	XF4BS/Administrator
	77	11/8/2022 9:26 AM	Recording reason	Session Recording Agent	Applications = BVT_DB/Desktop/###Desktop...	XF4BS/Administrator
	76	11/4/2022 2:13 PM	Recording reason	Session Recording Agent	Applications = BVT_DB/Desktop/###Desktop...	XF4BS/Administrator
	75	11/4/2022 2:12 PM	Recording reason	Session Recording Agent	Applications = BVT_DB/Desktop/###Desktop...	XF4BS/Administrator

Recording reason logging

This part logs which policies have triggered recordings.

To enable recording reason logging, enable both administrator logging and recording reason logging on your Session Recording servers. If administrator logging is disabled, enabling recording reason

logging does not take effect. For information about enabling recording reason logging, see [Disable or enable the recording reason logging](#).

ID	Logging Time	File ID	Action	Action Executed By
256	11/4/2022 2:42 PM	7ec9705b-2202-47e4-b8dc-ed43823506b0	Enter playback justification	XF485/Administrator
255	11/4/2022 2:26 PM	4502244b-ba4c-417e-9a73-c92055f621bb	Enter playback justification	XF485/Administrator
254	11/4/2022 2:24 PM	8715bd68-1e78-4fed-89e6-1c50b74535c9	Enter playback justification	XF485/Administrator
253	11/4/2022 2:23 PM	4502244b-ba4c-417e-9a73-c92055f621bb	Enter playback justification	XF485/Administrator
252	11/4/2022 2:23 PM	4502244b-ba4c-417e-9a73-c92055f621bb	Session file download	XF485/Administrator
251	11/4/2022 2:23 PM	4502244b-ba4c-417e-9a73-c92055f621bb	Session file download	XF485/Administrator
250	11/4/2022 2:22 PM	8715bd68-1e78-4fed-89e6-1c50b74535c9	Enter playback justification	XF485/Administrator
249	11/4/2022 2:13 PM	8715bd68-1e78-4fed-89e6-1c50b74535c9	Enter playback justification	XF485/Administrator
248	11/4/2022 2:13 PM	8715bd68-1e78-4fed-89e6-1c50b74535c9	Enter playback justification	XF485/Administrator
247	11/4/2022 2:13 PM	8715bd68-1e78-4fed-89e6-1c50b74535c9	Session file download	XF485/Administrator

Playback logging

This part logs playback-related actions. For more information about each log record, click the plus sign (+) in the **Action Details** column.

To log playback justifications, enable both administrator logging and playback justification logging on your Session Recording servers. If administrator logging is disabled, enabling playback justification logging does not take effect.

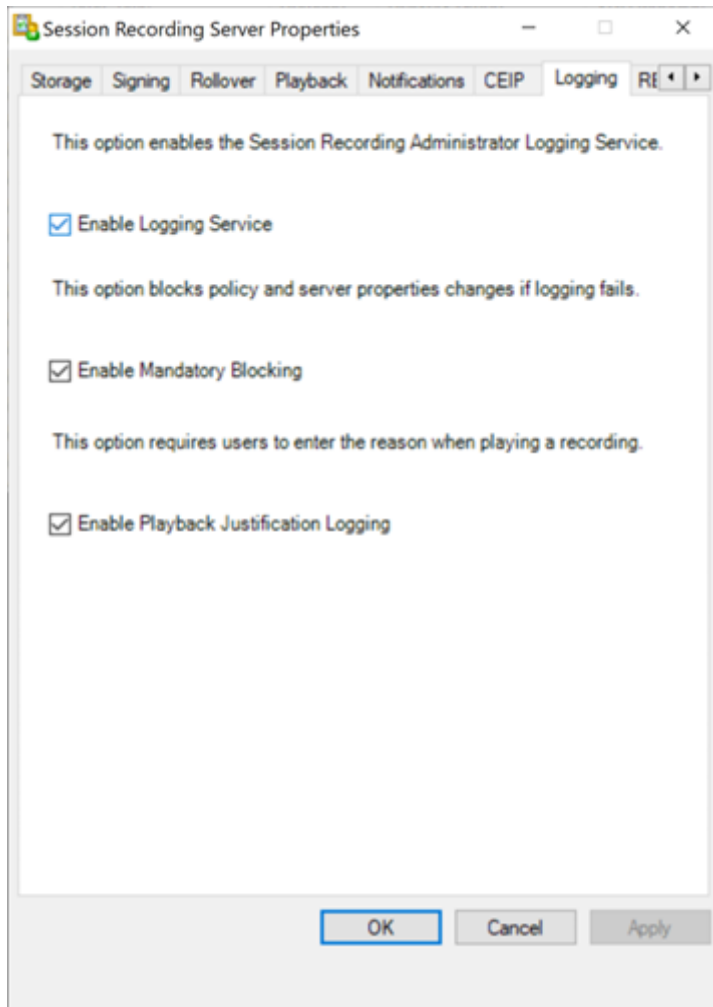

With playback justification logging enabled, each time you play a recording, a dialog box appears, asking you to enter a playback justification. For example, see the following screen captures:

Justification required for playback in the web player:

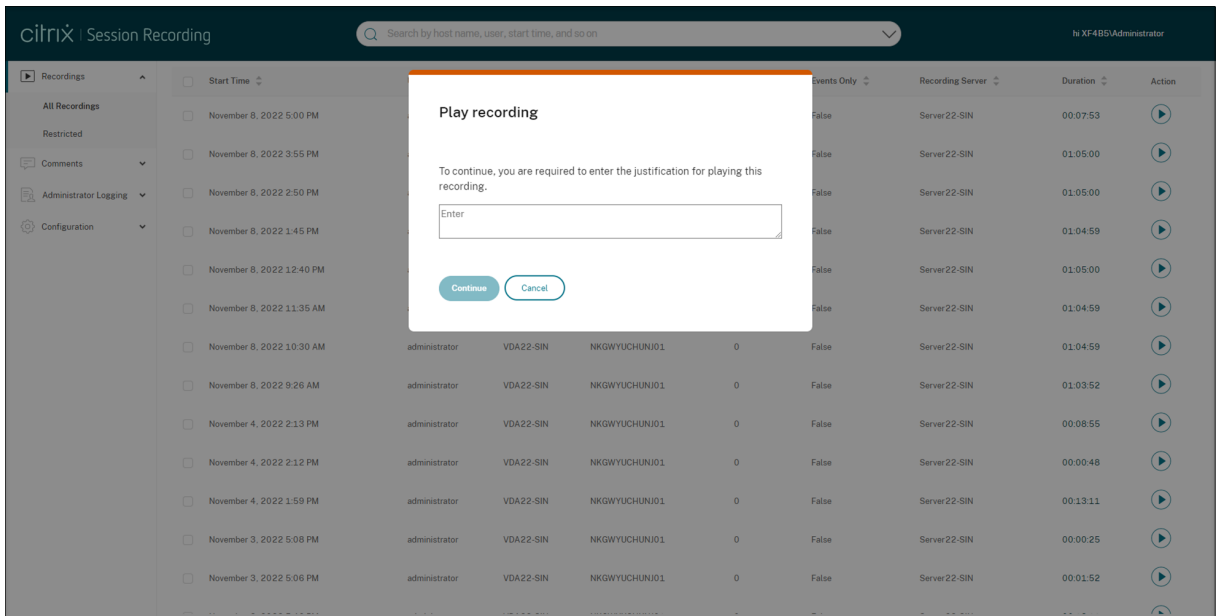

Justification required for playback in the Session Recording player:

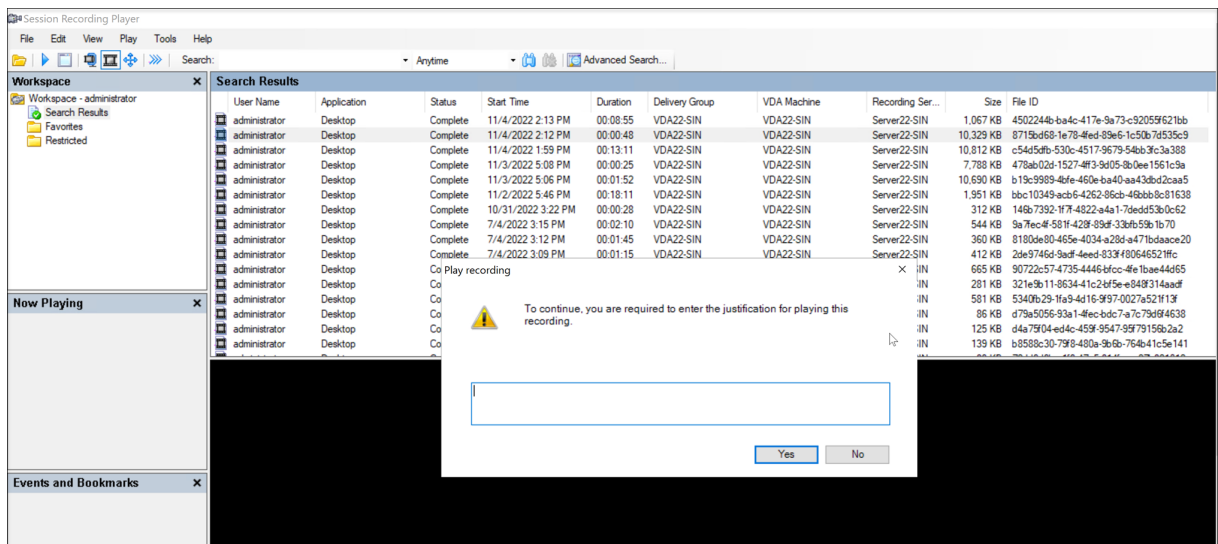

On the condition that playback justification logging is enabled on a Session Recording server, mind the following tips for using playback justifications:

- If you use a player that connects to a Session Recording server, a justification is required, even for recording files that you downloaded to a local path.
- A single session can generate multiple recordings because of file rollover. When you play back such a recorded session, you must enter a justification for each of its recordings.

Disable or enable administrator logging

After installation, you can disable or enable the Session Recording administrator logging feature in **Session Recording Server Properties**.

1. As an administrator, log on to the machine where Session Recording administrator logging is installed.
2. From the **Start** menu, choose **Session Recording Server Properties**.
3. Click the **Logging** tab.

When Session Recording administrator logging is disabled, no new activities are logged. You can query the existing logs from the web-based UI.

When **mandatory blocking** is enabled, the following activities are blocked if the logging fails. A system event is also logged with an Event ID 6001:

- Changes to recording policies on the Session Recording Policy Console or Citrix Director.
- Changes in Session Recording Server Properties.

The mandatory blocking setting does not impact the recording of sessions.

Configure an administrator logging service account

By default, administrator logging is running as a web application in Internet Information Services (IIS), and its identity is Network Service. To enhance the security level, you can change the identity of this web application to a service account or a specific domain account.

1. As an administrator, log on to the machine hosting the Session Recording server.
2. In IIS Manager, click **Application Pools**.
3. In **Application Pools**, right-click **SessionRecordingLoggingAppPool** and choose **Advanced Settings**.
4. Change the attribute **identity** to the specific account that you want to use.
5. Grant the **db_owner** permission to the account for the database **CitrixSessionRecordingLogging** on the Microsoft SQL Server.
6. Grant the read permission to the account for the registry key at **HKEY_LOCAL_MACHINE\SOFTWARE\Citrix**

Warning:

Editing the registry incorrectly can cause serious problems that might require you to re-install your operating system. Citrix cannot guarantee that problems resulting from the

incorrect use of the Registry Editor can be solved. Use the Registry Editor at your own risk. Be sure to back up the registry before you edit it.

Disable or enable the recording reason logging

By default, administrator logging logs every recording reason after the policy query completes. This behavior might generate many logs. To improve the performance and save the storage, disable this kind of logging in the registry.

1. As an administrator, log on to the machine hosting the Session Recording server.
2. Open the Registry Editor.
3. Browse to **HKEY_LOCAL_MACHINE\SOFTWARE\Citrix\SmartAuditor\Server**.
4. Set the value of **EnableRecordingActionLogging** to:
 - 0**: disable the recording reason logging
 - 1**: enable the recording reason logging

Best practices

December 3, 2024

You can consult the following best practices documentation for deploying Session Recording and configuring load balancing:

- [Configure load balancing in an existing deployment](#)
- [Deploy and load-balance Session Recording in Azure](#)

Configure load balancing in an existing deployment

December 18, 2024

You can add load balancing nodes using Citrix ADC in an existing Session Recording deployment. The following servers are used as an example. You can also [deploy and load-balance Session Recording in Azure](#).

- Session Recording

Host Name	Server Role	OS	IP Address
SRServer1	Session Recording server	Windows Server	10.63.32.55
LBDC	Domain controller	Windows Server	10.63.32.82
TSVDA	Session Recording agent	Windows Server	10.63.32.215
SRSQL	Session Recording database and the file server	Windows Server	10.63.32.91

All Session Recording components and the domain controller share a domain, for example, `lb.com`. The domain administrator account, for example, `lb\administrator`, is used for server logon.

- Citrix ADC

Host Name	Server Role	Management IP Address (NSIP)	Subnet IP Address (SNIP)
Netscaler	Citrix ADC VPX instance	10.63.32.40	10.63.32.109

For more information, see [Deploy a Citrix ADC VPX instance](#).

Step 1: Create shared folders on the file server

1. Log on to the file server by using a domain administrator account, for example, `lb\administrator`.
2. Create a folder to store recordings and name the folder `SessionRecording`, for example, `C:\SessionRecording`. Share the Read/Write permission of the folder with a Session Recording server. Using `SRServer1` as an example, type `LB\SRSERVER1$`. The dollar sign `$` is required.

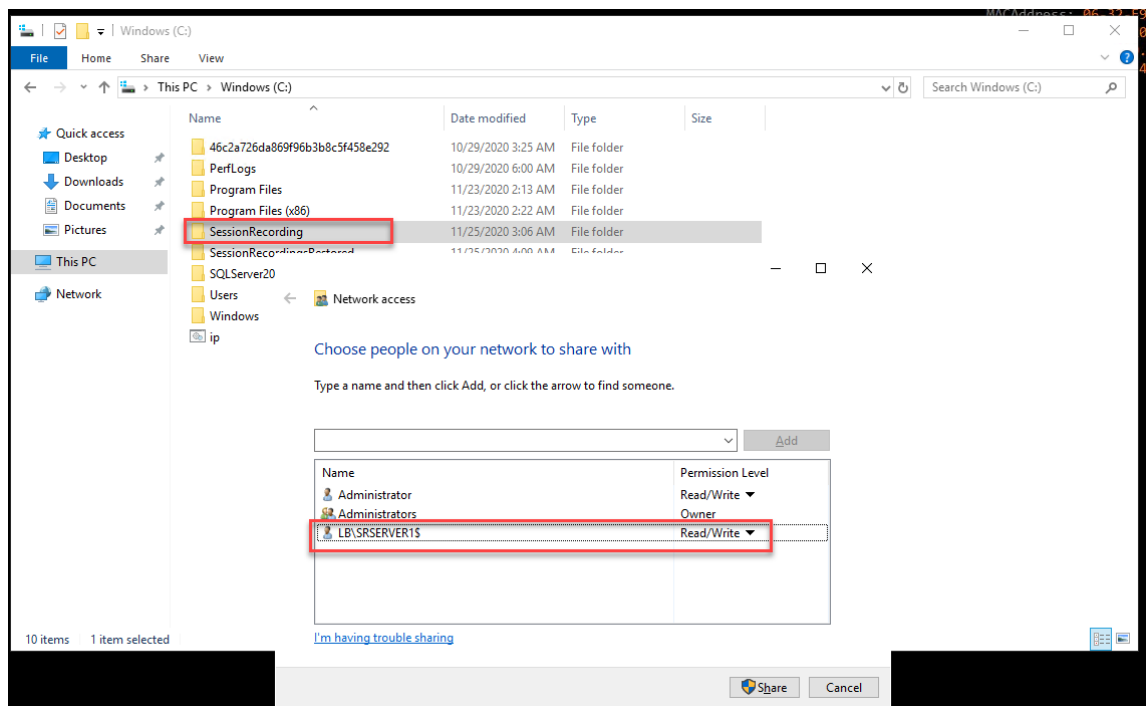
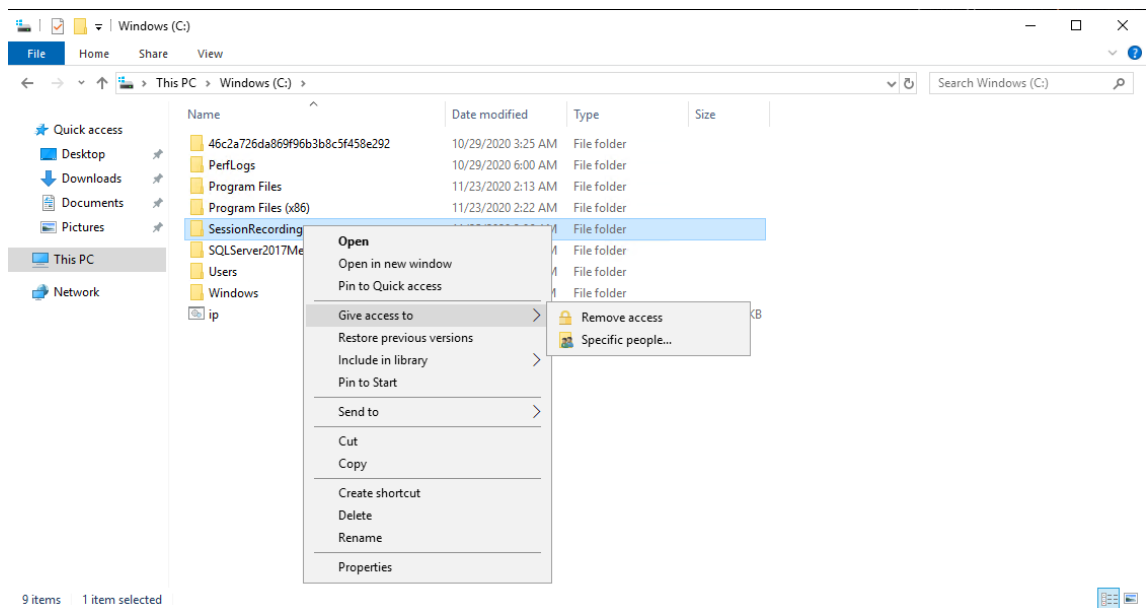

3. Create a subfolder within the `SessionRecording` folder and name the subfolder `share`, for example, `C:\SessionRecording\share`.

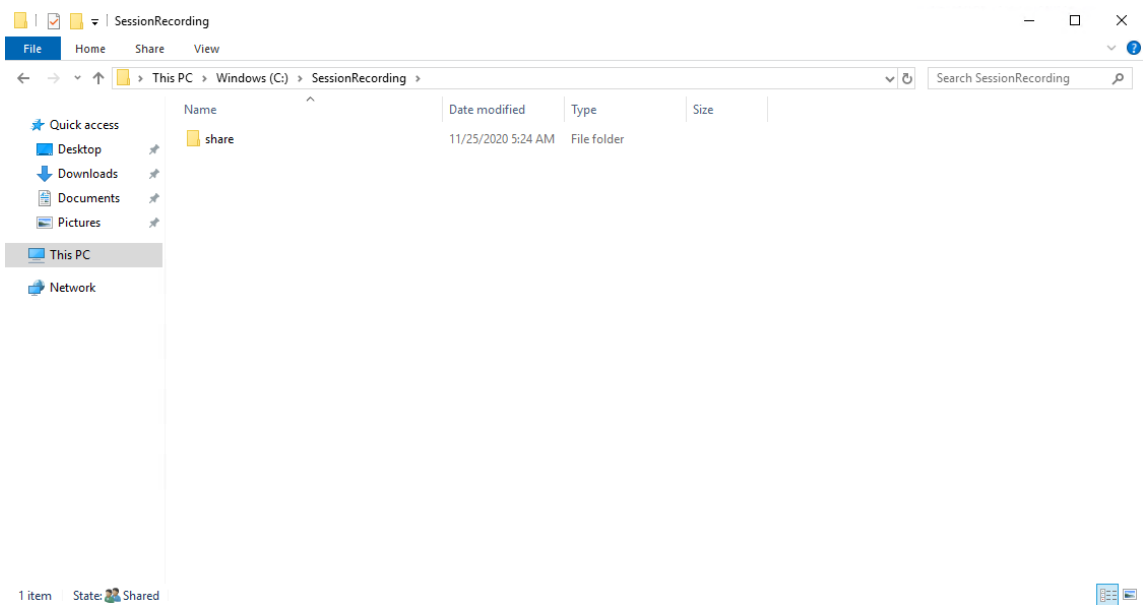

4. Create another folder to restore archived recordings and name the folder `SessionRecordingsRestored`, for example, `C:\SessionRecordingsRestored`. Share the Read/Write permission of the folder with a Session Recording server. Using `SRServer1` as an example, type `LB\SRSERVER1$`. The dollar sign `$` is required.
5. Create a subfolder within the `SessionRecordingsRestored` folder and name the subfolder `share`, for example, `C:\SessionRecordingsRestored\share`.

Step 2: Configure an existing Session Recording server to support load balancing

This step describes how to configure an existing Session Recording server to support load balancing. [Step 7](#) details the procedure of adding more Session Recording servers to your existing deployment.

1. Log on to a Session Recording server by using a domain administrator account.
2. Open **Session Recording Server Properties**.

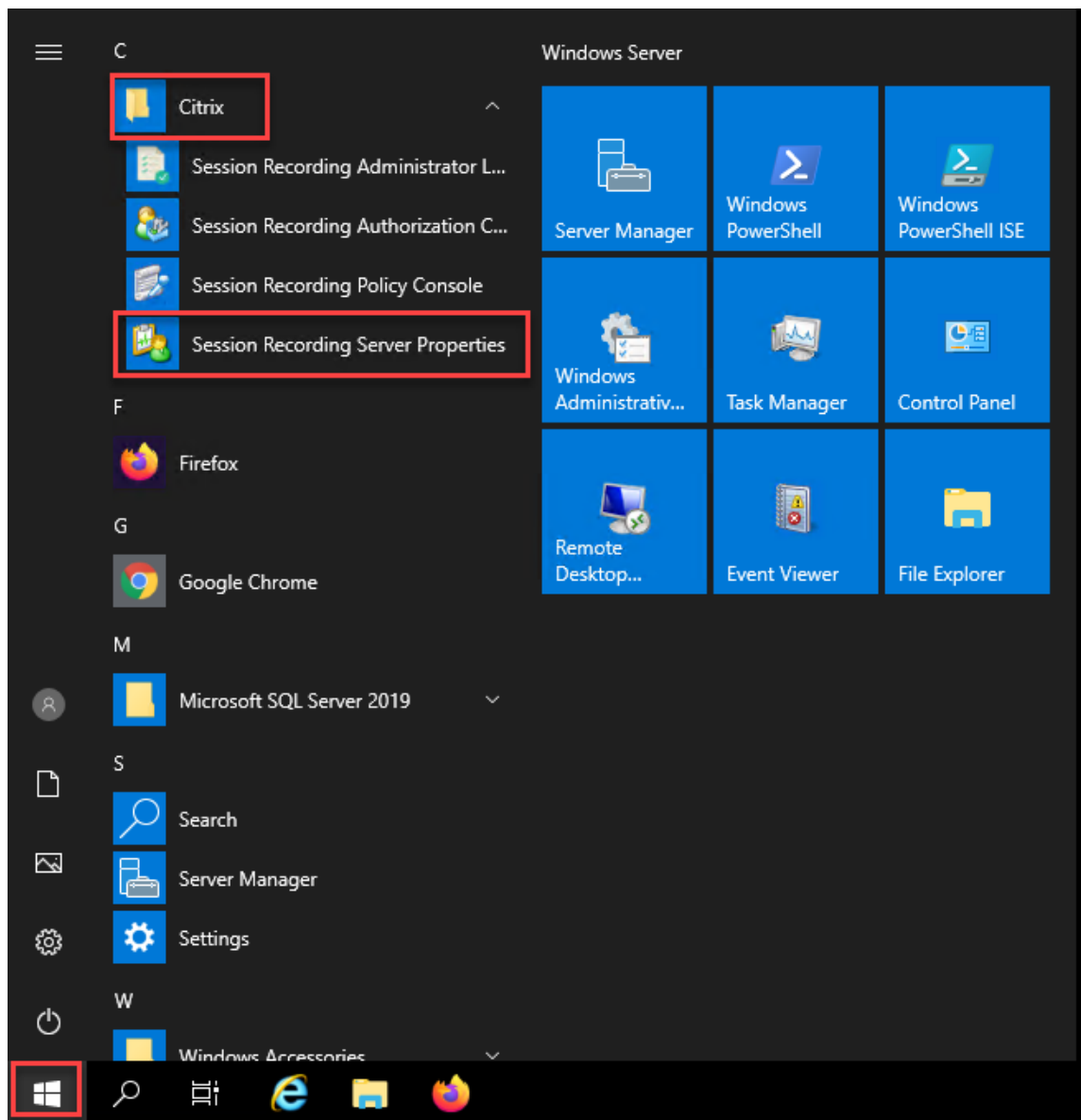

3. Add the Universal Naming Convention (UNC) paths created in [Step 1](#) to store and restore recording files, in this example, `\\SRSQL\SessionRecording\share` and `\\SRSQL\SessionRecordingRestored\share`. SRSQL is the host name of the file server.

Note:

The Session Recording player cannot play files under a path that contains a drive letter or a dollar sign (\$). The exception is that you install the player and the Session Recording server on the same machine.

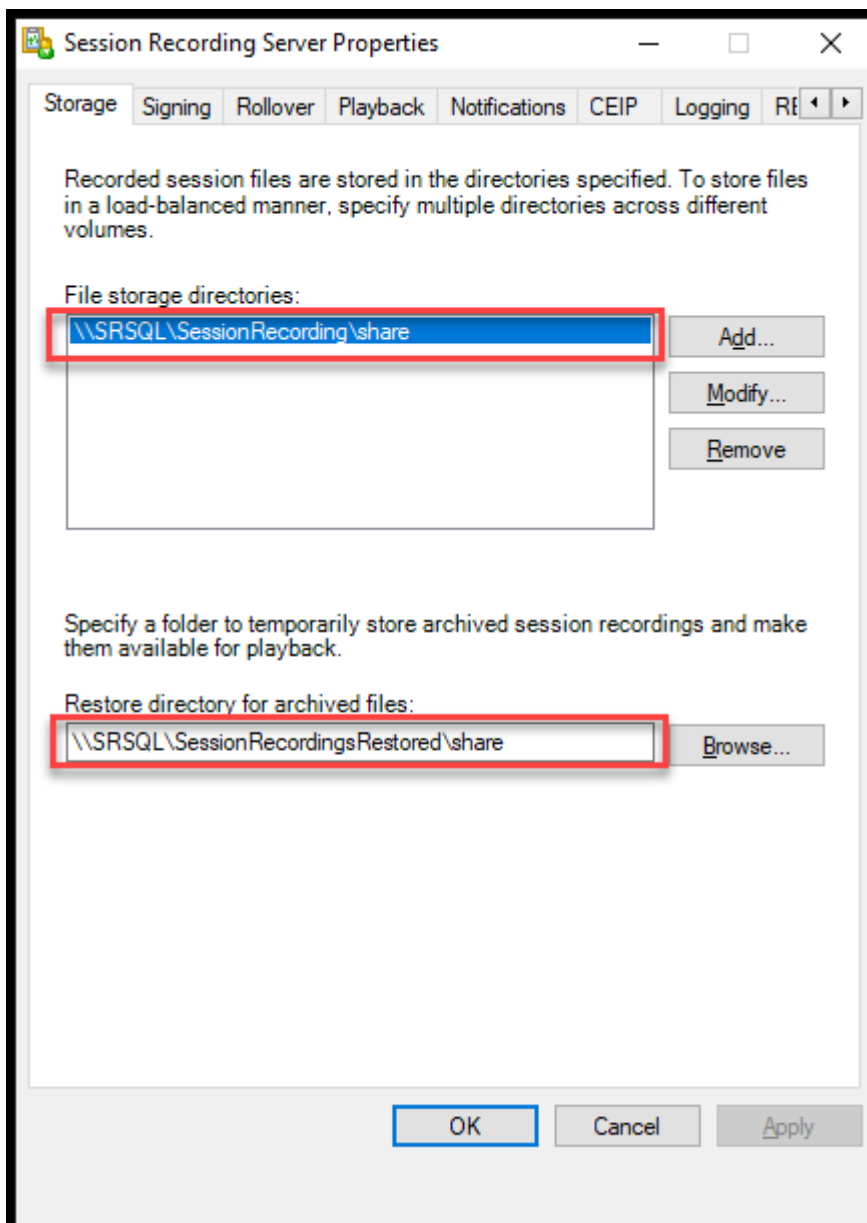

4. Add a value to the Session Recording server registry key at `HKEY_LOCAL_MACHINE\SOFTWARE\Citrix\SmartAuditor\Server`.

Value name: EnableLB

Value data: 1 (D_WORD, meaning enable)

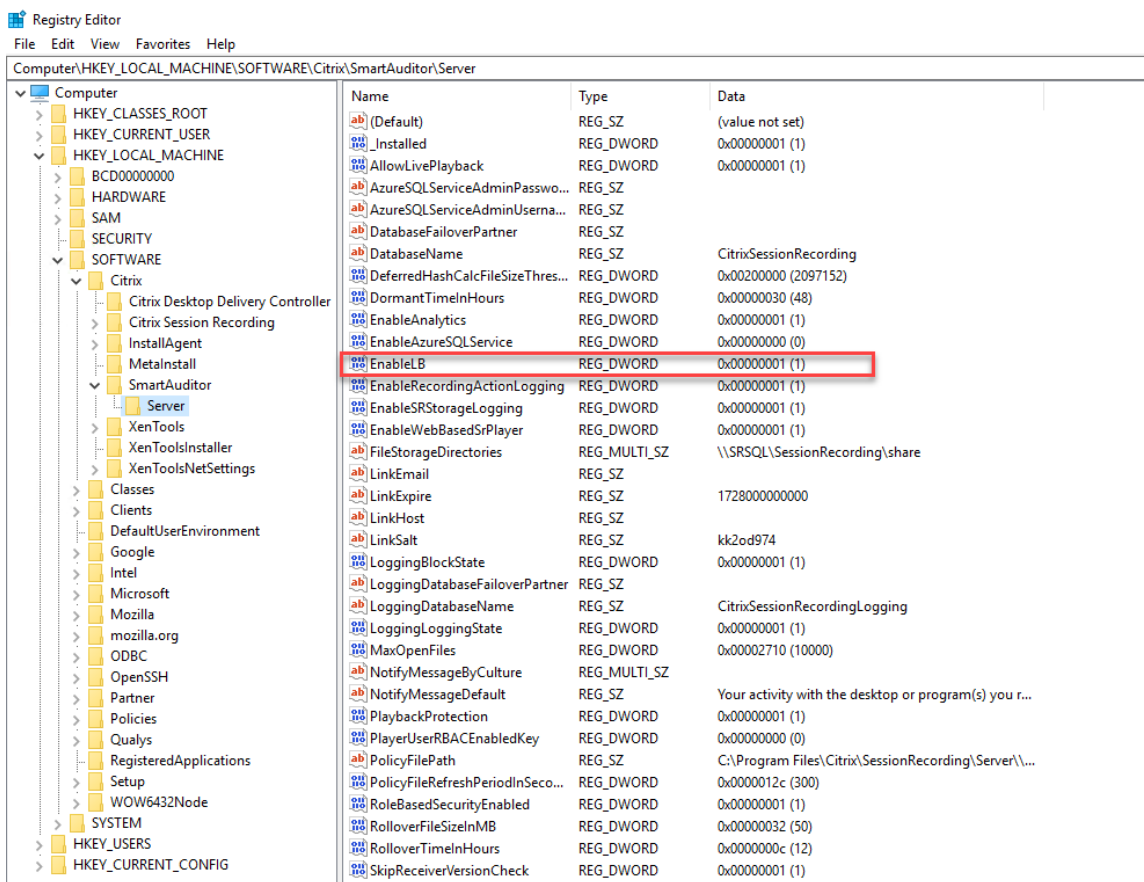

5. Restart the Citrix Session Recording Storage Manager service.

Step 3: Configure load balancing in Citrix ADC

There are two ways to configure load balancing in Citrix ADC - TCP passthrough and SSL offloading.

Configure load balancing through TCP passthrough

The following topologies show how to configure load balancing through **TCP passthrough**.

- If you are using the Python-based WebSocket server (Version 1.0):

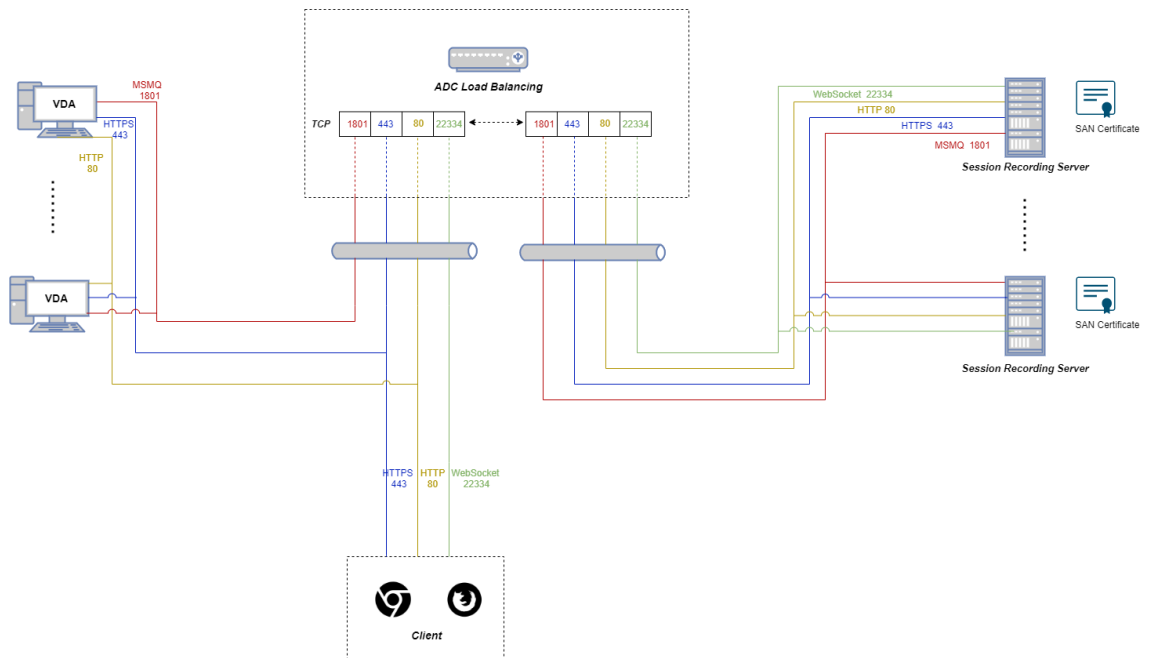

- If you are using the WebSocket server hosted in IIS (Version 2.0):

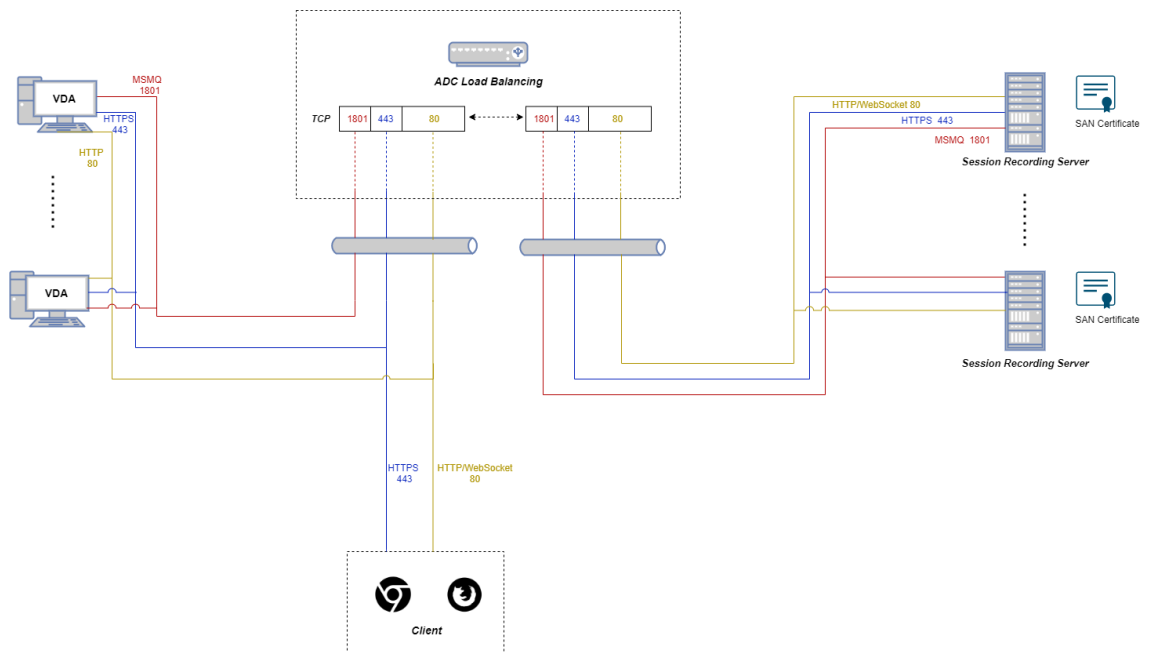

To configure load balancing through TCP passthrough, complete the following steps:

1. Log on to your Citrix ADC VPX instance.
2. Navigate to **Configuration > System > Settings > Configure Basic Features**.

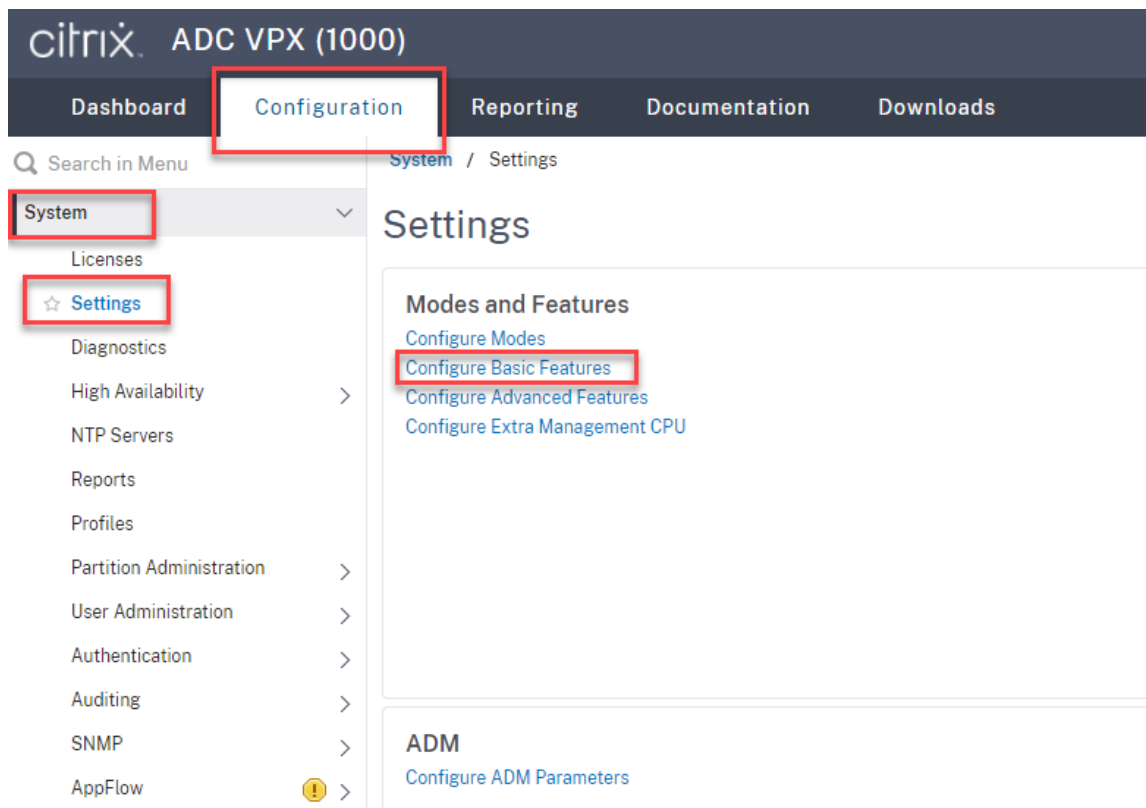

3. Select **Load Balancing** and click **OK**.

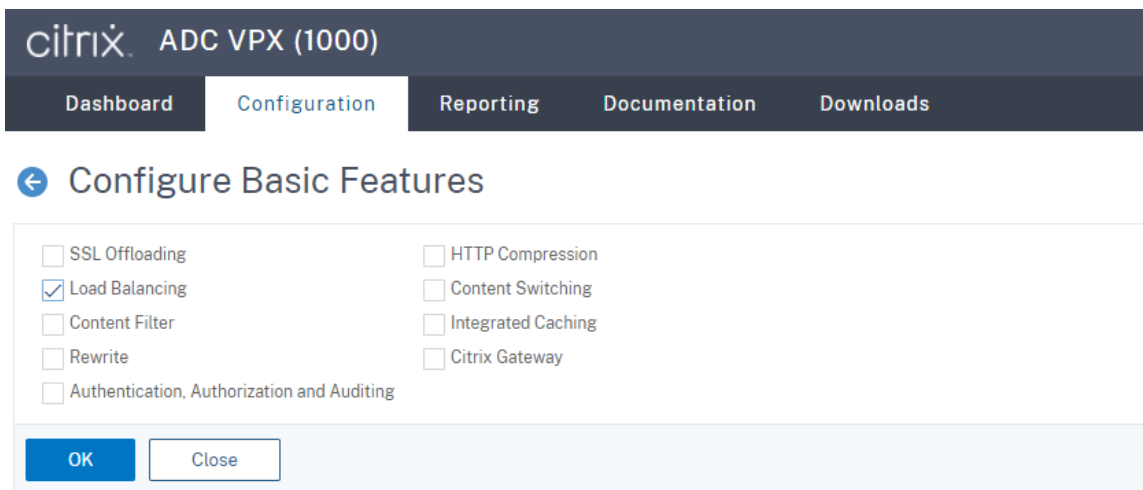

4. Add load balancing servers.

Navigate to **Traffic Management > Load Balancing > Servers** and click **Add**.

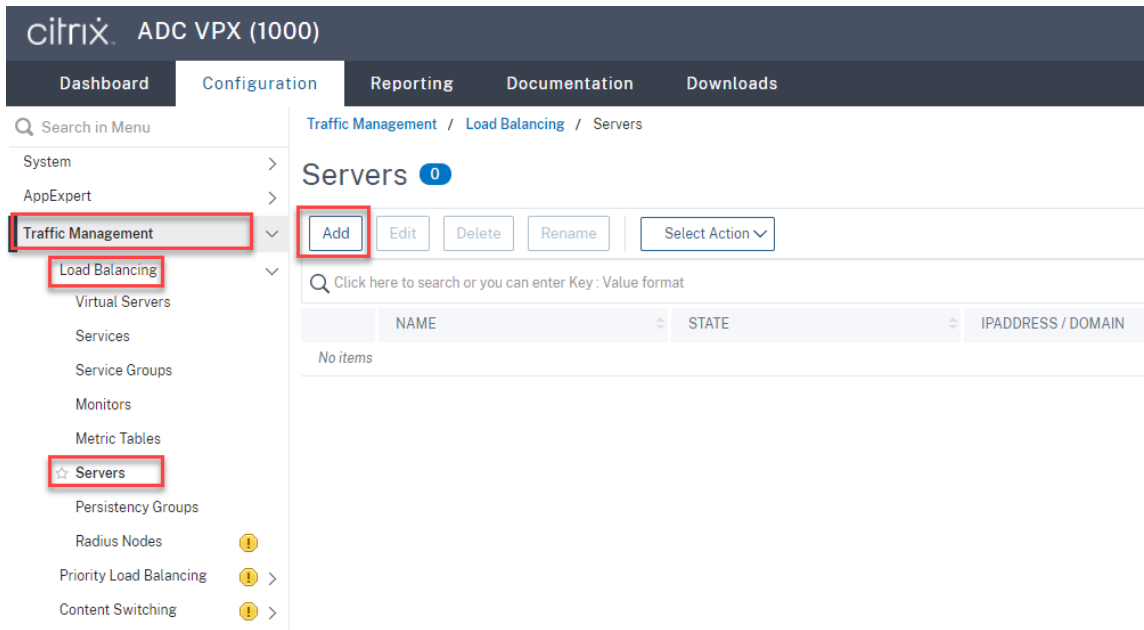

Type the name and IP address of a Session Recording server and then click **Create**. For example:

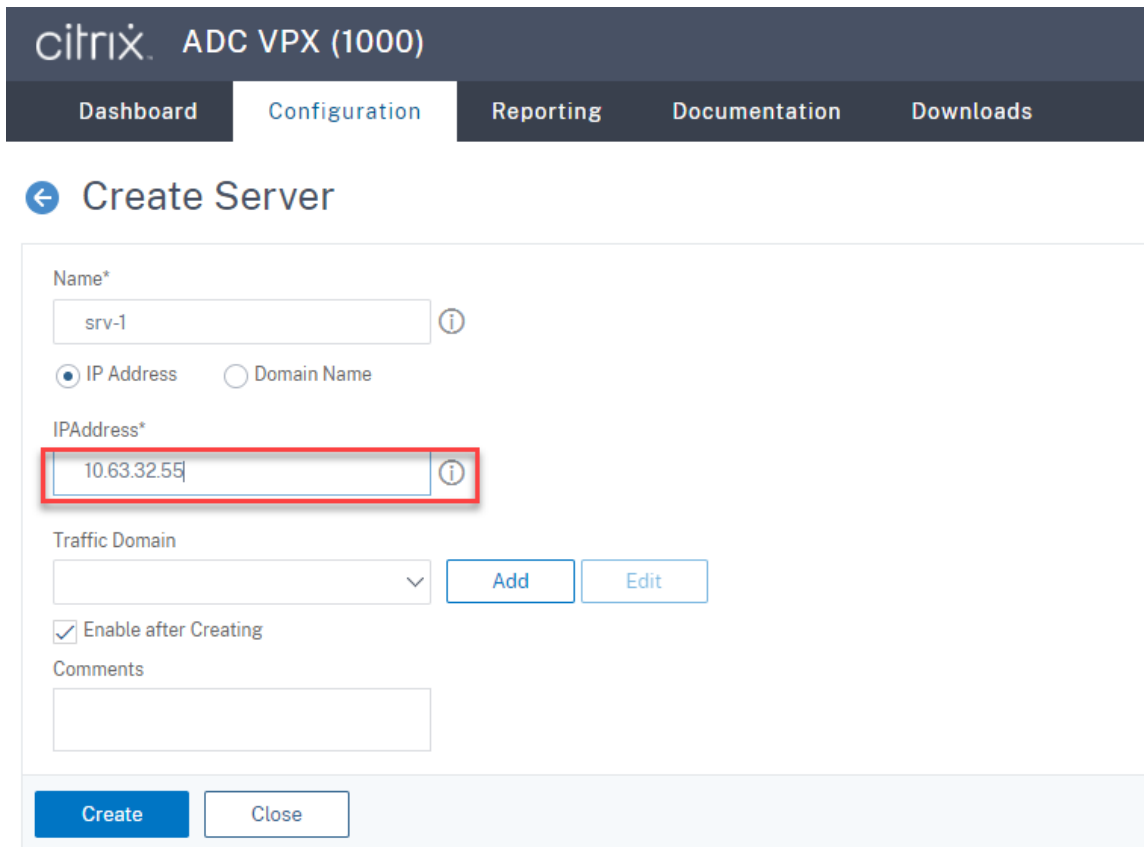

Click the save icon in the upper right corner to save your changes.



- For WebSocket server Version 1.0, add **load balancing services** of ports 80, 1801, 22334, and 443 for each Session Recording server. For WebSocket server Version 2.0, add **load balancing services** of ports 80, 1801, and 443 for each Session Recording server.

Navigate to **Traffic Management > Load Balancing > Services** and click **Add**.

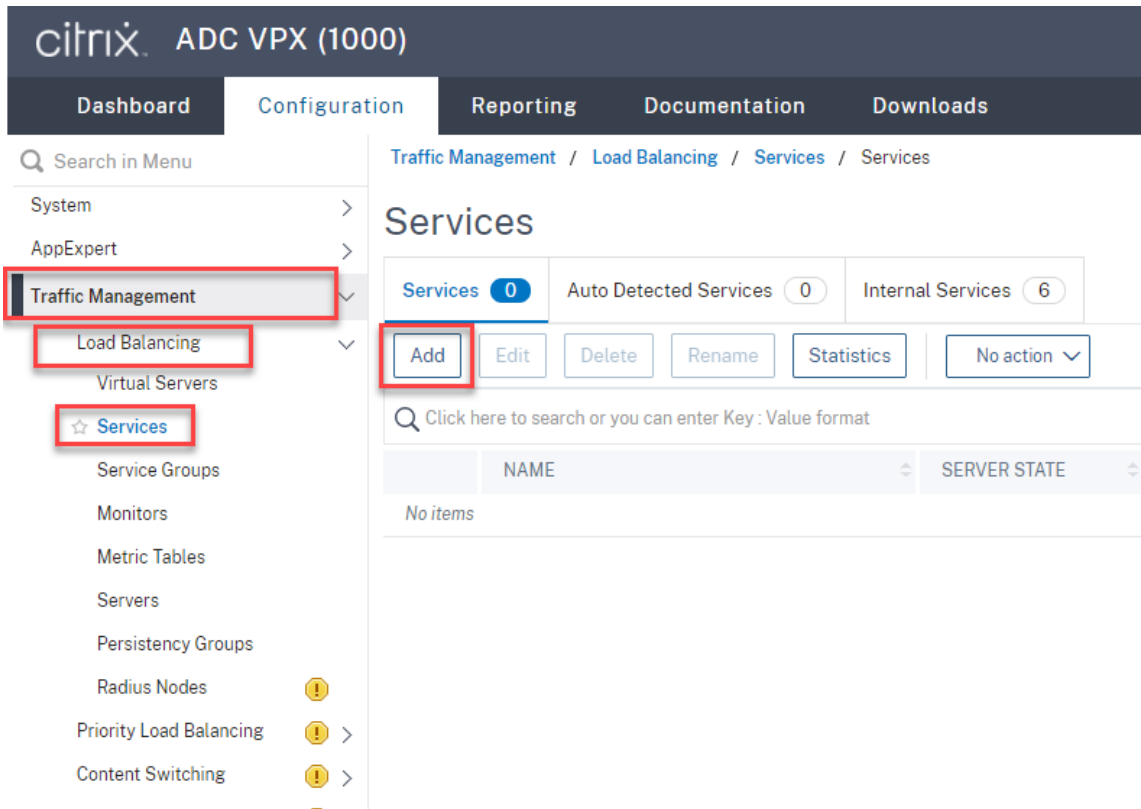

Type a name for each **load balancing service** that you add. Choose **Existing Server**, select the IP address of your target Session Recording server, select **TCP** as the server protocol, and type a port number. Click **OK**.

citrix ADC VPX (1000)

Dashboard Configuration Reporting Documentation Downloads

← Load Balancing Service

Basic Settings

Service Name*
 ⓘ

New Server Existing Server

Server*
 ▾

Protocol*
 ▾ ⓘ

Port*
 ⓘ

▶ More

Bind the TCP protocol monitor to each load balancing service.

The screenshot shows the Citrix ADC VPX (1000) Configuration page for a Load Balancing Service. The 'Load Balancing Monitor Binding' dialog is open, showing 'tcp' selected as the monitor. The 'Bind' button is highlighted. In the background, the 'Monitors' section shows '1 Service to Load Balancing Monitor Binding'.

Click the save icon in the upper right corner to save your changes.

Traffic Management / Load Balancing / Services / Services

Services [Save Icon]

Services (4) Auto Detected Services (0) Internal Services (6)

Add Edit Delete Statistics Action Search

	Name	State	IP Address/Domain Name	Port	Protocol	Max Clients	Max Requests	Cache Type	Traffic Domain
<input type="checkbox"/>	srv-1-1801	UP	10.63.32.55	1801	TCP	0	0	SERVER	0
<input type="checkbox"/>	srv-1-22334	UP	10.63.32.55	22334	TCP	0	0	SERVER	0
<input type="checkbox"/>	srv-1-443	UP	10.63.32.55	443	TCP	0	0	SERVER	0
<input checked="" type="checkbox"/>	srv-1-80	UP	10.63.32.55	80	TCP	0	0	SERVER	0

Tip:

The **load balancing service** of port 22334 is required only for WebSocket server Version 1.0.

6. Add **load balancing virtual servers**.

For WebSocket server Version 1.0, complete the following steps to add **load balancing virtual servers** of ports 80, 443, 1801, and 22334. For WebSocket server Version 2.0, add **load balancing virtual servers** of ports 80, 443, and 1801. For example:

Session Recording 2407

Traffic Management / Load Balancing / Virtual Servers

Virtual Servers

Add Edit Delete Enable Disable Statistics Action

<input type="checkbox"/>	Name	State	Effective State	IP Address	Port	Protocol	Method	Persistence	% Health	Traffic Domain
<input type="checkbox"/>	vsvr-80	UP	UP	10.63.32.60	80	TCP	LEASTBANDWIDTH	SOURCEIP	100.00% 1 UP/0 DOWN	0
<input type="checkbox"/>	vsvr-1801	UP	UP	10.63.32.60	1801	TCP	LEASTBANDWIDTH	SOURCEIP	100.00% 1 UP/0 DOWN	0
<input type="checkbox"/>	vsvr-443	UP	UP	10.63.32.60	443	TCP	LEASTBANDWIDTH	SOURCEIP	100.00% 1 UP/0 DOWN	0
<input type="checkbox"/>	vsvr-22334	UP	UP	10.63.32.60	22334	TCP	LEASTBANDWIDTH	SOURCEIP	100.00% 1 UP/0 DOWN	0

Navigate to **Traffic Management > Load Balancing > Virtual Servers** and click **Add**.

citrix ADC VPX (1000)

Dashboard Configuration Reporting Documentation Downloads

Search in Menu

- System >
- AppExpert >
- Traffic Management** >
- Load Balancing >
- Virtual Servers** >
- Services
- Service Groups
- Monitors
- Metric Tables
- Servers
- Persistency Groups
- Radius Nodes !
- Priority Load Balancing ! >
- Content Switching ! >

Traffic Management / Load Balancing / Virtual Servers

Virtual Servers 1

Add Edit Delete Enable Disable Rename Statistics Select Action

Click here to search or you can enter Key : Value format

NAME	STATE	EFFECTIVE STATE	IP ADDRESS
No items			
Total 0			

Add each virtual server with the Citrix ADC VIP address based on the TCP protocol.

Citrix ADC VPX (1000)
Dashboard Configuration Reporting Documentation Downloads

← Load Balancing Virtual Server

Basic Settings

Create a virtual server by specifying a name, an IP address, a port, and a protocol type. If an application is accessible from the Internet, the virtual server IP (VIP) address is a public network (WAN), the VIP is usually a private (ICANN non-routable) IP address. You can configure multiple virtual servers to receive client requests, thereby increasing the availability of resources to process client requests.

Name* ⓘ

Protocol* ⓘ

IP Address Type* ⓘ

IP Address* ⓘ

Port* ⓘ

▶ More

Bind each virtual server to the **load balancing service** of the same port. For example:

Citrix ADC VPX (1000)
Dashboard Configuration Reporting Documentation Downloads

← Load Balancing Virtual Server

Load Balancing Virtual Server | [Export as a Template](#)

Basic Settings

Name	vsrv-80	Listen Priority	-
Protocol	TCP	Listen Policy Expression	NONE
State	● DOWN	Redirection Mode	IP
IP Address	10.63.32.60	Range	1
Port	80	IPset	-
Traffic Domain	0	RHI State	PASSIV
		AppFlow Logging	ENABL
		Retain Connections on Cluster	NO
		TCP Probe Port	-

Services and Service Groups

A service is a logical representation of an application running on a server.
 A service group enables you to manage a group of services as though it were a single service. After creating a service group, you can bind it to a virtual server, and you can add services.
Note: Bind at least one service or service group to the virtual server.

Click **Continue** to display the advanced settings and select the method, persistence type, and any other configuration detail that you might need.

No Load Balancing Virtual Server Service Binding

No Load Balancing Virtual Server ServiceGroup Binding

The screenshot shows the Citrix ADC VPX (1000) configuration interface. The main navigation bar includes Dashboard, Configuration, Reporting, Documentation, and Downloads. The current page is titled "Load Balancing Virtual Server" and is under the "Configuration" tab. The left sidebar shows "Basic Settings" for a virtual server named "vsrv-80" with protocol TCP, state DOWN, IP address 10.63.32.60, port 80, and traffic domain 0. Below this, it shows "Services and Service Groups" with "No Load Balancing Virtual Server Service Binding" and "No Load Balancing Virtual Server ServiceGroup Binding". The "Traffic Settings" section includes Health Threshold (0), Client Idle Time-out (9000), Minimum Autoscale Members (0), Maximum Autoscale Members (0), and ICMP Virtual Server Response (PASSIVE). A "Done" button is at the bottom of the sidebar.

The right sidebar is titled "Service Binding / Service" and shows "Service 4". It has three buttons: "Select", "Add" (highlighted with a red box), and "Edit". Below the buttons is a search bar with the text "Click here to search or you can enter Key : Value format". A table lists four services with checkboxes and names:

<input type="checkbox"/>	NAME
<input type="checkbox"/>	srv-1-80
<input type="checkbox"/>	srv-1-443
<input type="checkbox"/>	srv-1-1801
<input type="checkbox"/>	srv-1-22334

At the bottom of the right sidebar, it says "Total 4".

Choose a load balancing method.

Method

Method is a load balancing algorithm that the Citrix ADC uses to s

Load Balancing Method*

LEASTBANDWIDTH ⓘ

New Service Startup Request Rate

0

Backup LB Method*

ROUNDROBIN

New Service Request unit*

PER_SECOND

Increment Interval

Configure persistence on each virtual server. We recommend you select **SOURCEIP** as the persistence type. For more information, see [Persistence settings](#).

Persistence

Configure persistence to route all connections from the same user persistence type fails.

Select Persistence Type*

SOURCEIP
 RULE
 OTHERS
 (i)

Time-out (mins)*

IPv4 Netmask

IPv6 Mask Length

7. Create a host record for the Citrix ADC VIP address on the domain controller.

DNS Manager

File Action View Help

Forward Lookup Zones

- lb.com
 - Netscaler (Host (A)) - 10.63.32.60 - static
 - SRServer1 (Host (A)) - 10.63.32.55 - 11/19/2020 2:00:00 AM
 - SRServer2 (Host (A)) - 10.63.32.68 - 11/19/2020 11:00:00 PM
 - SRSQL (Host (A)) - 10.63.32.91 - 11/23/2020 3:00:00 AM
 - TSVDA (Host (A)) - 10.63.32.215 - 11/23/2020 2:00:00 AM

Name	Type	Data	Timestamp
(same as parent folder)	Start of Authority (SOA)	[47], lbdc.lb.com., hostma...	static
(same as parent folder)	Name Server (NS)	lbdc.lb.com.	static
(same as parent folder)	Host (A)	10.63.32.82	11/19/2020 2:00:00 AM
lbdc	Host (A)	10.63.32.82	static
LBDDC	Host (A)	10.63.32.11	11/19/2020 11:00:00 PM
Netscaler	Host (A)	10.63.32.60	static
SRServer1	Host (A)	10.63.32.55	11/19/2020 2:00:00 AM
SRServer2	Host (A)	10.63.32.68	11/19/2020 11:00:00 PM
SRSQL	Host (A)	10.63.32.91	11/23/2020 3:00:00 AM
TSVDA	Host (A)	10.63.32.215	11/23/2020 2:00:00 AM

8. To access the web player over HTTPS, ensure that a SAN certificate is available both on Citrix ADC and on each Session Recording server. A SAN certificate contains the FQDNs of the Citrix ADC and of each Session Recording server.

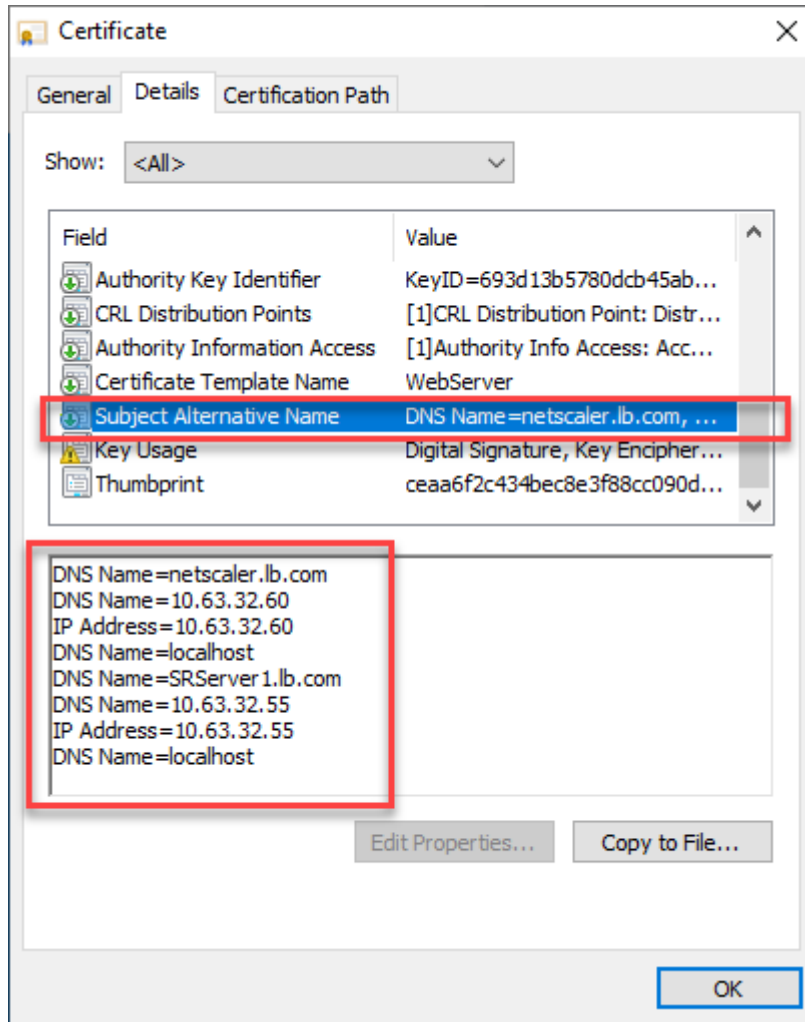

Configure load balancing through SSL offloading

The following topologies show how to configure load balancing through SSL offloading.

- If you are using the Python-based WebSocket server (Version 1.0):

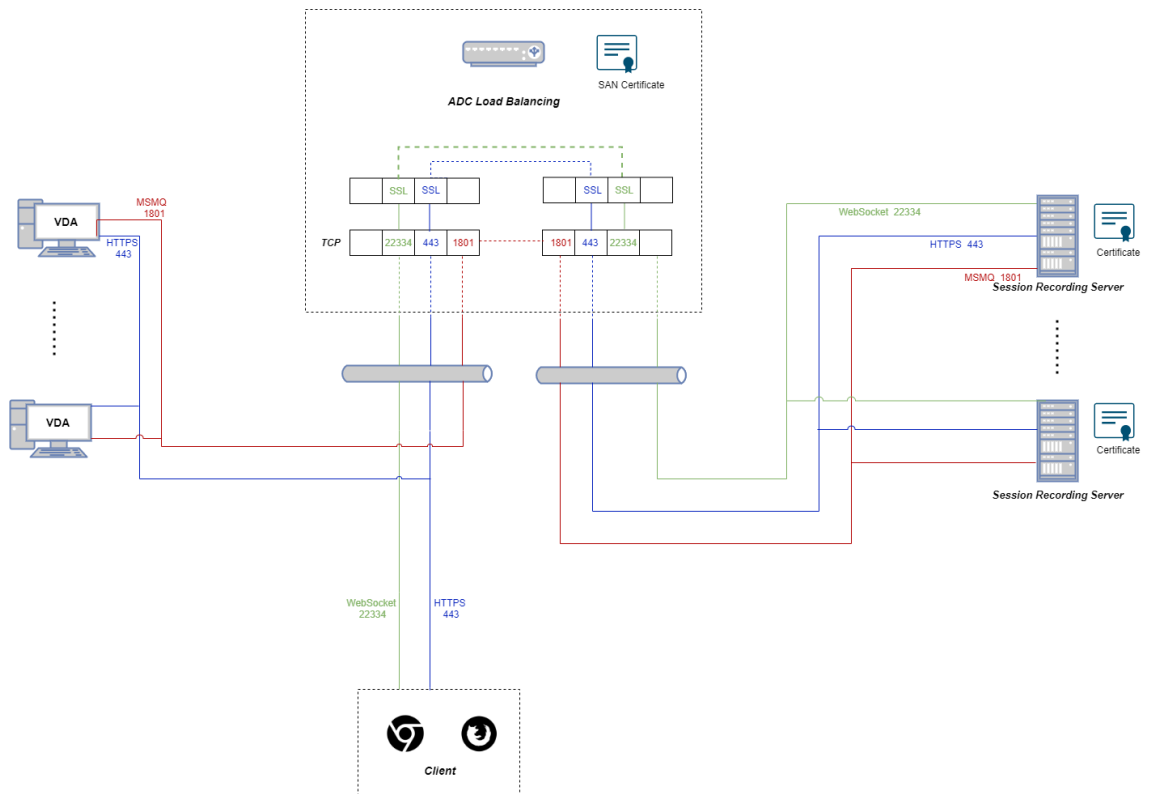

- If you are using the WebSocket server hosted in IIS (Version 2.0):

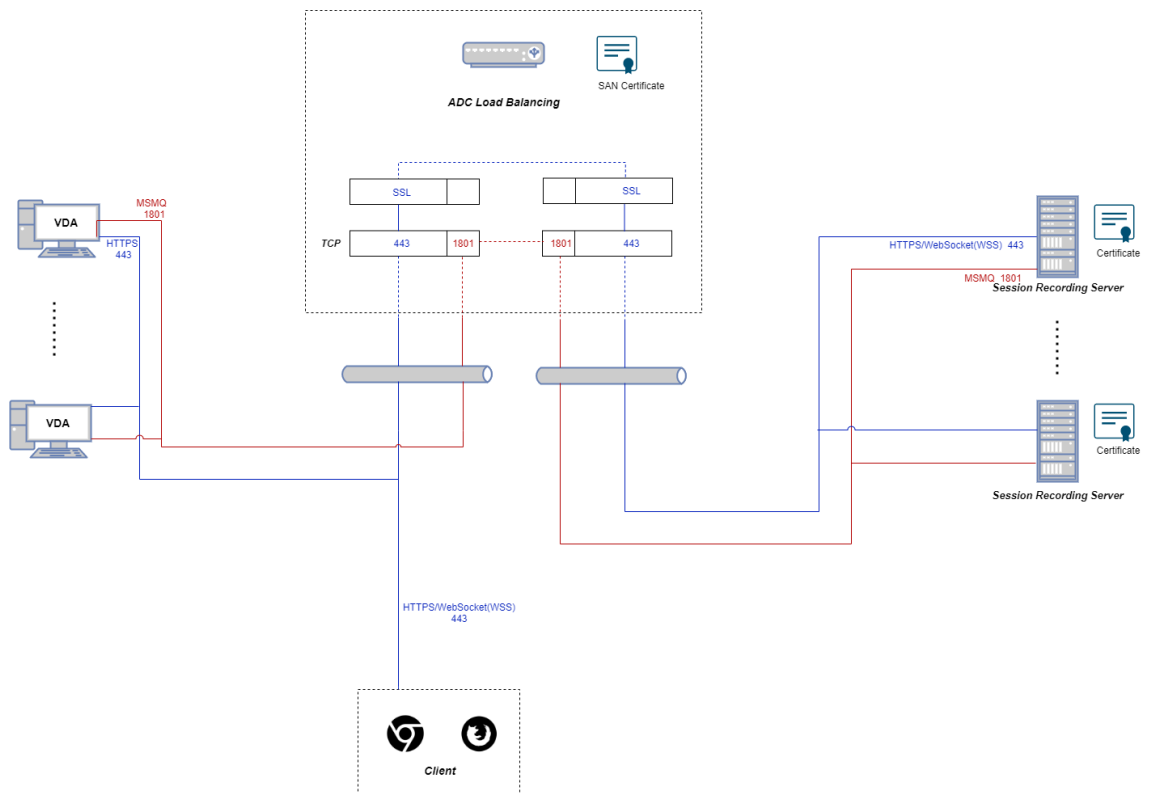

1. Log on to your Citrix ADC VPX instance.

2. Navigate to **Configuration > System > Settings > Configure Basic Features**.

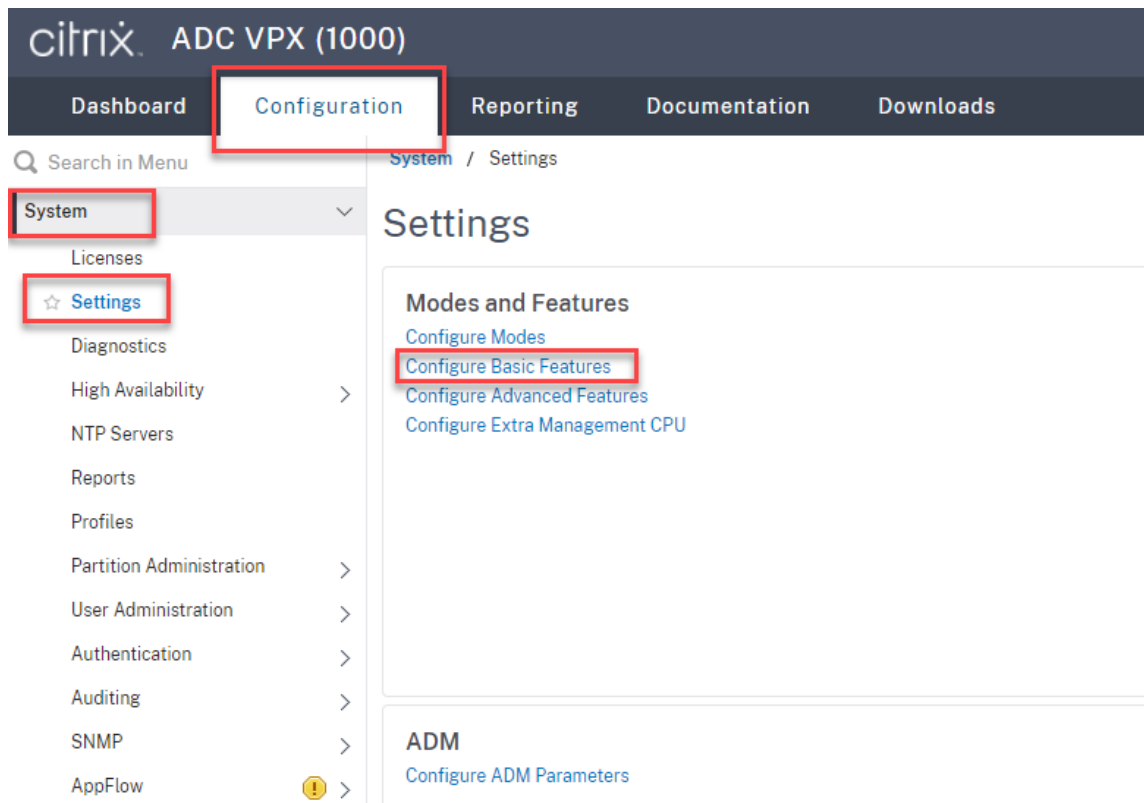

3. Select **SSL Offloading** and **Load Balancing** and click **OK**.

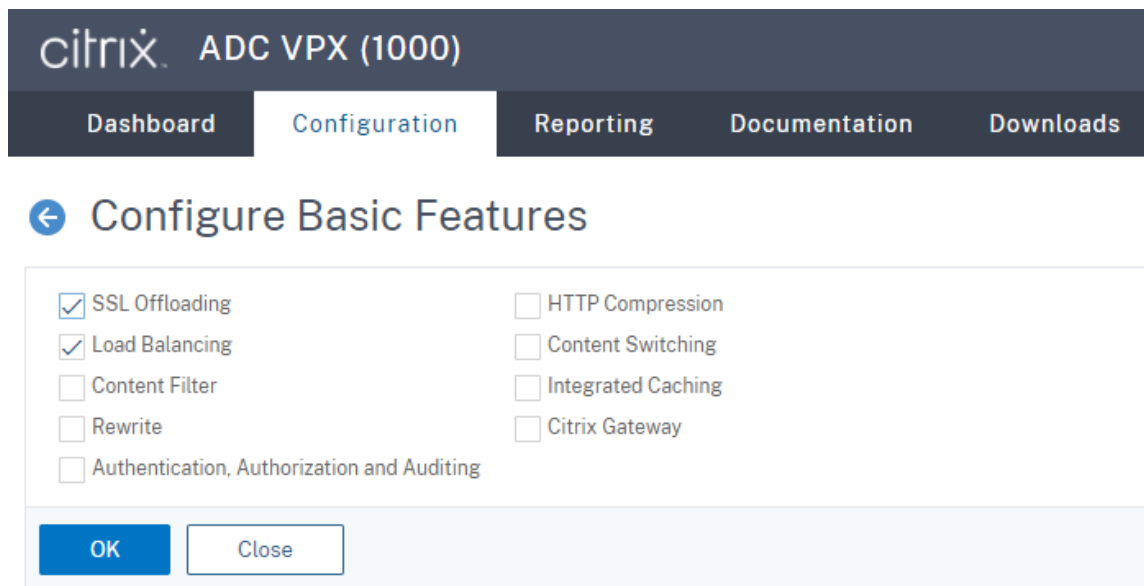

4. Add load balancing servers.

Navigate to **Traffic Management > Load Balancing > Servers** and click **Add**.



Type the name and IP address of a Session Recording server and then click **Create**. For example:

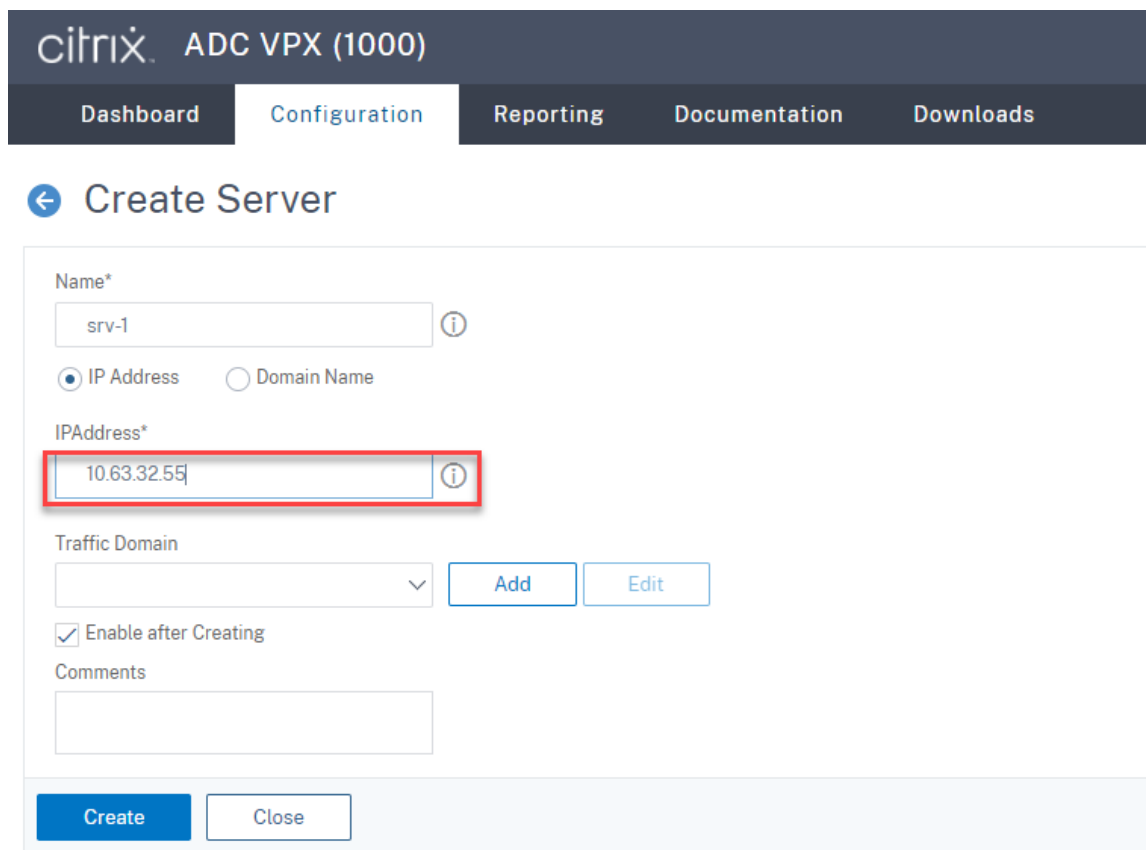

Click the save icon in the upper right corner to save your changes.

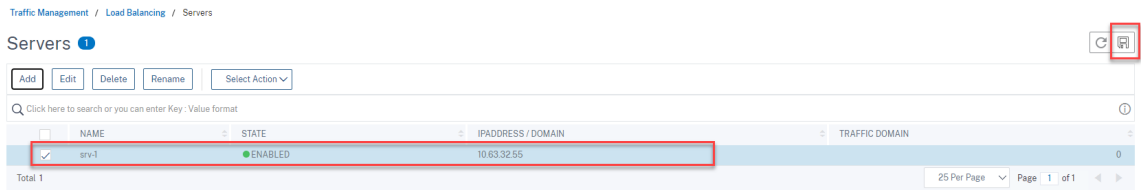

5. Add **load balancing services** for each Session Recording server that you added in the previous step.

Add the following **load balancing services** for each Session Recording server:

- (Required only when you are using the WebSocket server Version 1.0) **SSL load balancing service** of port 22334 that binds to the TCP monitor
- **SSL load balancing service** of port 443 that binds to the HTTPS monitor
- **TCP load balancing service** of port 1801 that binds to the TCP monitor

For example:

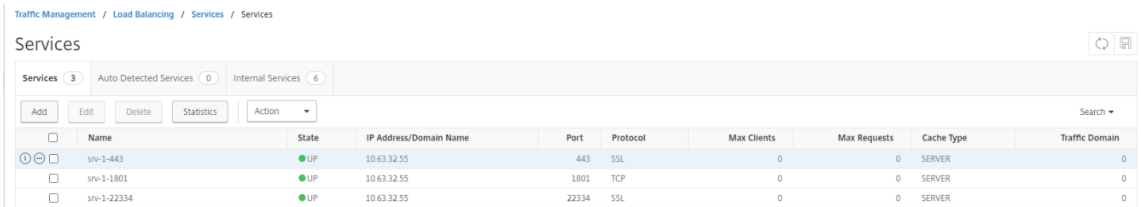

Navigate to **Traffic Management > Load Balancing > Services** and click **Add**.

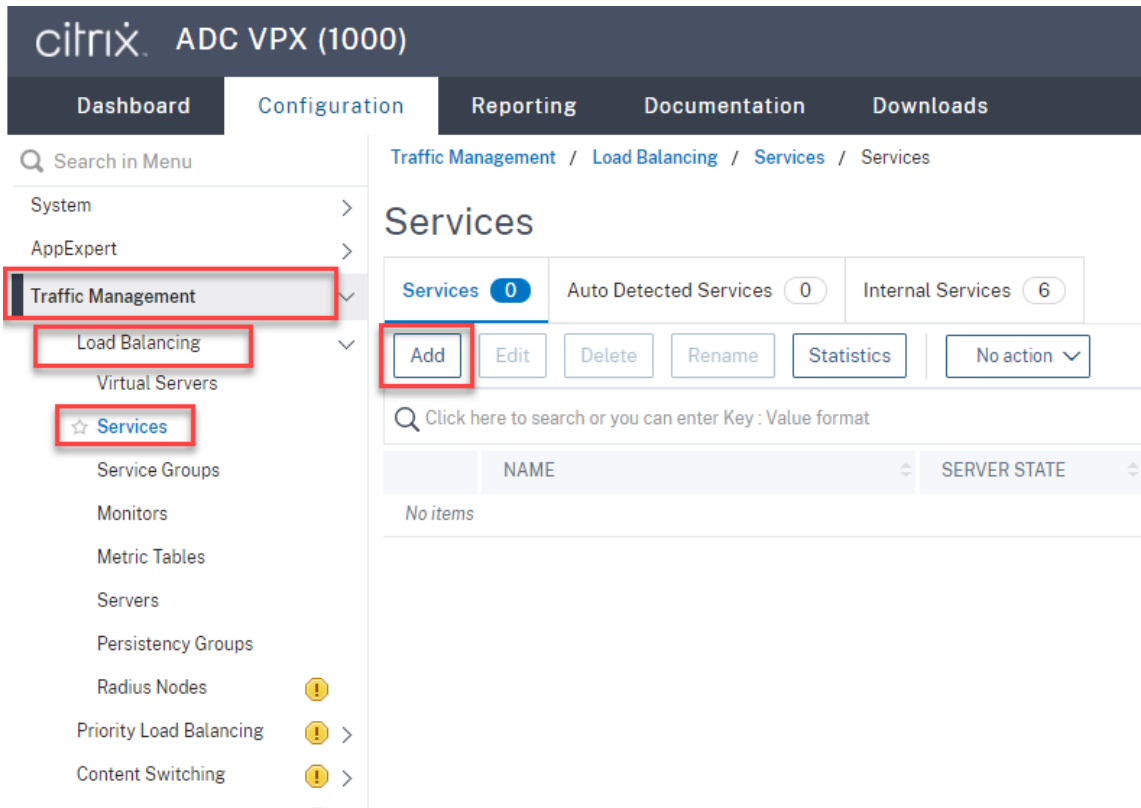

(Required only when you are using the WebSocket server Version 1.0) Add an SSL load balancing service of port 22334 for each Session Recording server. Type a name for the load balancing service, choose **Existing Server**, select the IP address of a Session Recording server, select **SSL** as the server protocol, type port number **22334**, and click **OK**.

For example, see the following screen capture.

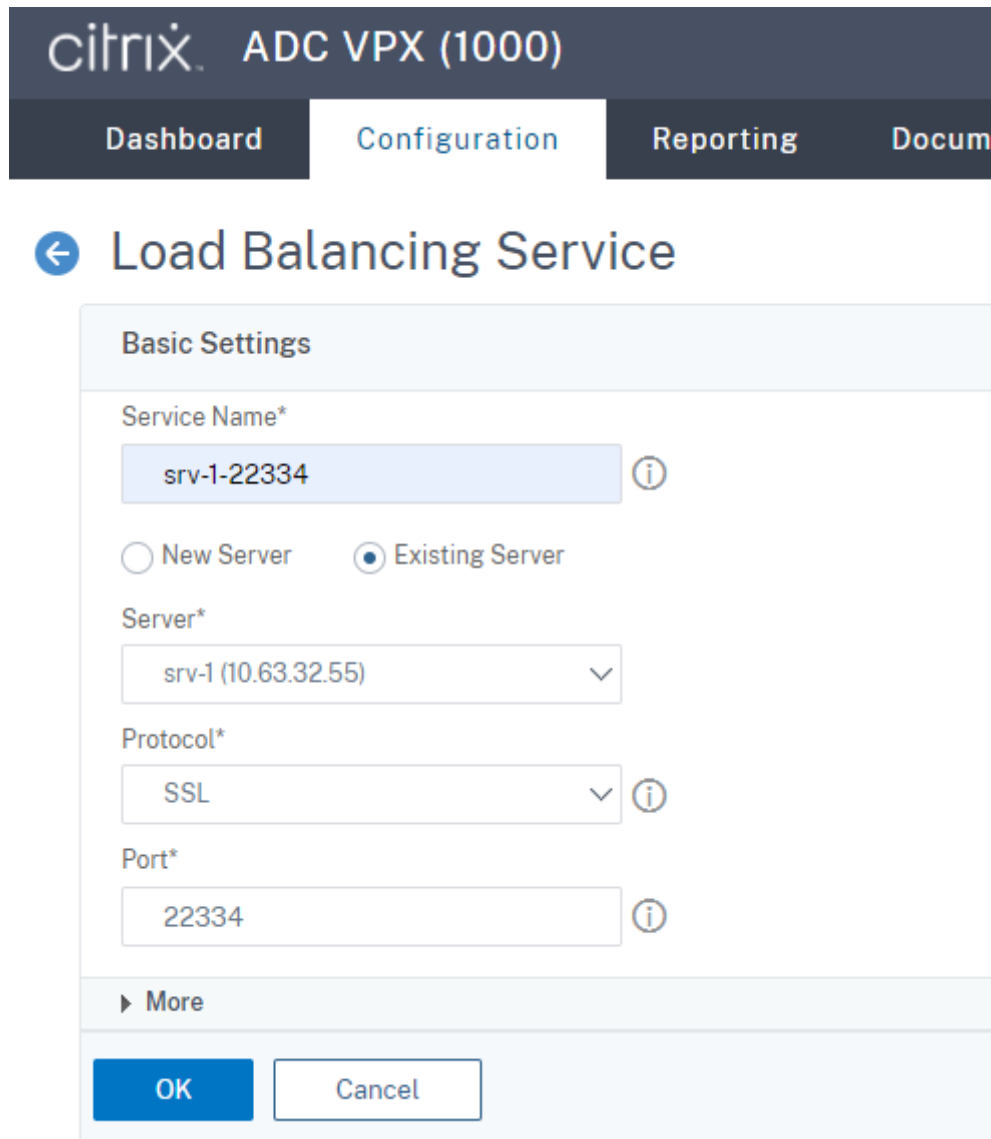

The screenshot shows the Citrix ADC VPX (1000) Configuration page. The navigation tabs are Dashboard, Configuration, Reporting, and Documents. The main heading is "Load Balancing Service". The "Basic Settings" section includes the following fields:

- Service Name*: srv-1-22334
- Radio buttons: New Server, Existing Server
- Server*: srv-1 (10.63.32.55)
- Protocol*: SSL
- Port*: 22334

At the bottom of the form, there is a "More" section with a right-pointing arrow, and two buttons: "OK" and "Cancel".

Bind the TCP monitor to the **SSL load balancing service** you just added.

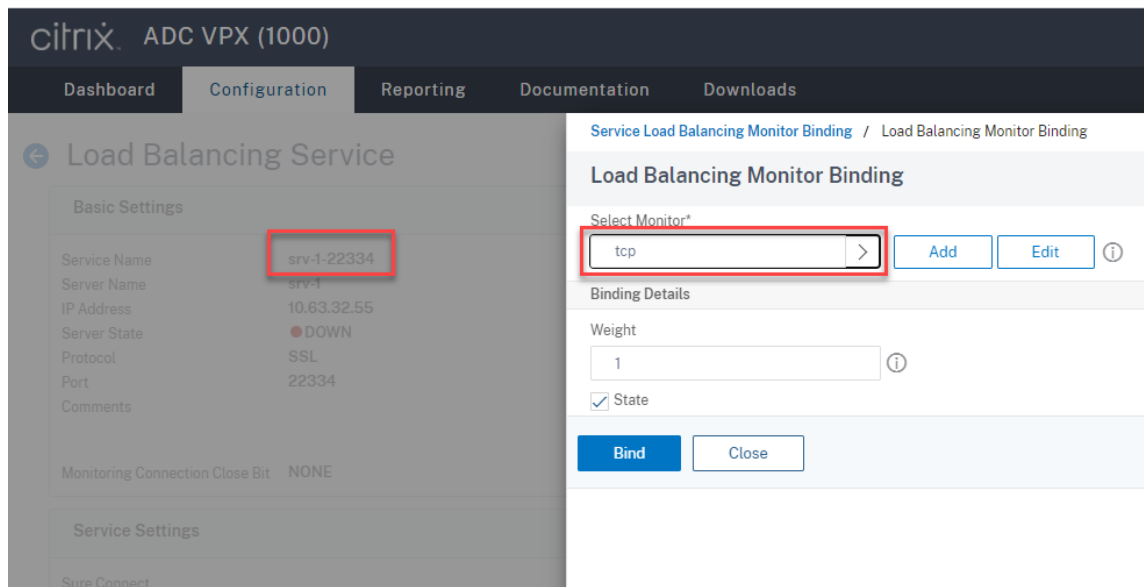

Add an SSL load balancing service of port 443 for each Session Recording server. Type a name for the load balancing service, choose **Existing Server**, select the IP address of a Session Recording server, select **SSL** as the server protocol, type port number 443, and click **OK**.

The screenshot shows the Citrix ADC VPX (1000) Configuration page. The navigation menu includes Dashboard, Configuration, Reporting, and Do. The main heading is "Load Balancing Service" with a back arrow. The "Basic Settings" section contains the following fields:

- Service Name*: srv-1-443 (with an information icon)
- Radio buttons: New Server, Existing Server
- Server*: srv-1 (10.63.32.55) (dropdown menu)
- Protocol*: SSL (dropdown menu)
- Port*: 443 (with an information icon)

Below the fields is a "More" section with a right-pointing arrow. At the bottom are "OK" and "Cancel" buttons.

Bind the HTTPS monitor to the **SSL load balancing service** you just added.

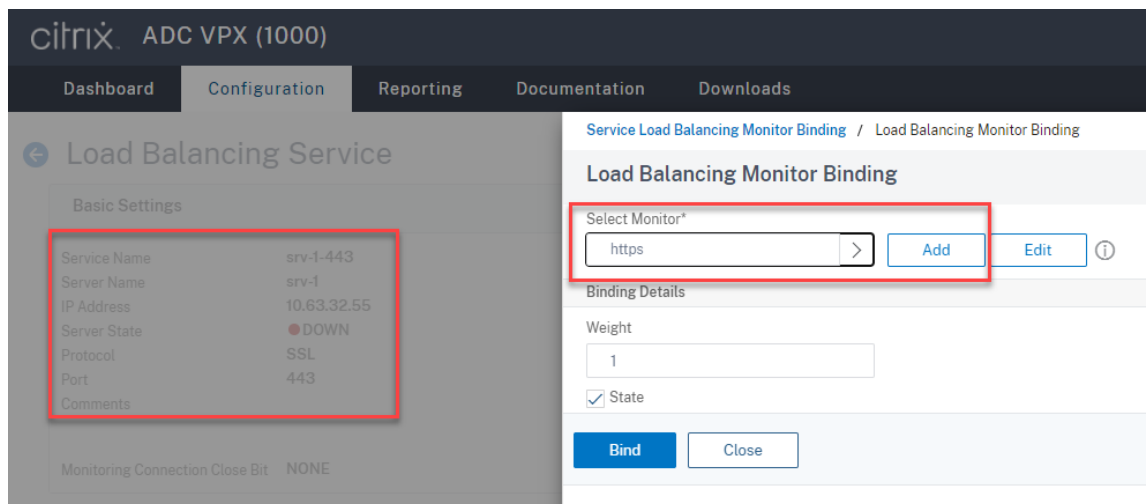

Add a TCP load balancing service of port 1801 for each Session Recording Server. Type a name for the load balancing service, choose **Existing Server**, select the IP address of a Session Recording server, select **TCP** as the server protocol, type port number 1801, and click **OK**.

The screenshot shows the Citrix ADC VPX (1000) Configuration page. The navigation tabs are Dashboard, Configuration, Reporting, and Documentation. The main heading is "Load Balancing Service" with a back arrow. The "Basic Settings" section contains the following fields:

- Service Name*: srv-1-1801 (with an information icon)
- Radio buttons: New Server, Existing Server
- Server*: srv-1 (10.63.32.55) (with a dropdown arrow)
- Protocol*: TCP (with a dropdown arrow and an information icon)
- Port*: 1801 (with an information icon)

Below the settings is a "More" section with a right-pointing arrow. At the bottom are "OK" and "Cancel" buttons.

Bind the TCP monitor to the **TCP load balancing service** you just added.

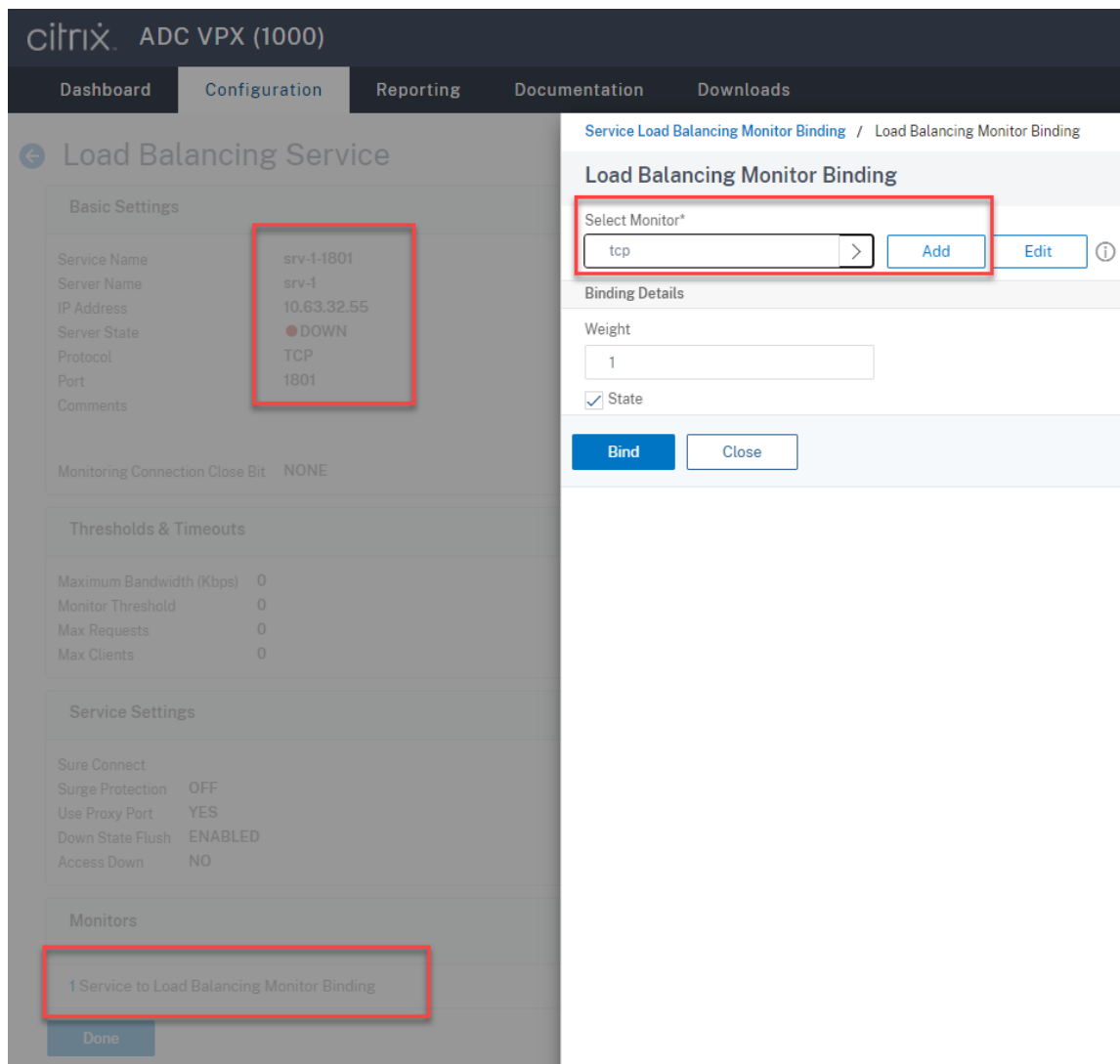

6. (Required only when you are using the WebSocket server Version 1.0) Add an HTTP profile for each **SSL load balancing service** of port 22334.

Navigate to **System > Profiles > HTTP Profiles** and click **Add**.

The screenshot shows the Citrix ADC VPX (1000) Configuration page. The breadcrumb trail is System / Profiles / HTTP Profiles. The main heading is 'Profiles'. Below the heading, there are buttons for 'Add', 'Edit', and 'Delete'. The 'Add' button is highlighted with a red box. Above the buttons, there are counters for 'TCP Profiles 13', 'HTTP Profiles 3', 'Database Profiles 0', and 'SSL Profil'. The 'HTTP Profiles 3' counter is also highlighted with a red box. Below the buttons, there is a search bar with the text 'Click here to search or you can enter Key : Value format'. Below the search bar, there is a table with the following columns: a checkbox, 'NAME', 'DROP INVALID', and 'INVALIDATE HTTP'. The table contains three rows of profiles:

<input type="checkbox"/>	NAME	DROP INVALID	INVALIDATE HTTP
<input type="checkbox"/>	nshttp_default_profile	✗	✗
<input type="checkbox"/>	nshttp_default_strict_validation	✓	✓
<input type="checkbox"/>	nshttp_default_internal_apps	✓	✓

At the bottom of the table, there is a 'Total 3' summary row.

Select the **Enable WebSocket connections** check box and accept the other default settings.

HTTP/2 Initial Window Size		
<input type="text" value="65535"/>		
HTTP/2 Maximum Concurrent Streams		
<input type="text" value="100"/>		
HTTP/2 Maximum Frame Size		
<input type="text" value="16384"/>		
HTTP/2 Minimum Server Connections		
<input type="text" value="20"/>		
HTTP/2 Maximum Header List Size		
<input type="text" value="24576"/>		
HTTP/2 Maximum Ping Frames Per Minute		
<input type="text"/>		
HTTP/2 Maximum Reset Frames Per Minute		
<input type="text"/>		
HTTP/2 Maximum Empty Frames Per Minute		
<input type="text"/>		
HTTP/2 Maximum Settings Frames Per Minute (i)		
<input type="text"/>		

<input type="checkbox"/> Alternative Service	<input checked="" type="checkbox"/> Connection Multiplexing	<input type="checkbox"/> Drop invalid HTTP requests
<input type="checkbox"/> Mark HTTP/0.9 requests as invalid	<input type="checkbox"/> Mark CONNECT Requests as Invalid	<input type="checkbox"/> Mark TRACE Requests as Inva
<input type="checkbox"/> Mark RFC7230 Non-Compliant Transaction as Invalid	<input type="checkbox"/> Mark HTTP Header with Extra White Space as Invalid	<input type="checkbox"/> Compression on PUSH packet
<input checked="" type="checkbox"/> Drop extra CRLF	<input checked="" type="checkbox"/> Enable WebSocket connections (i)	<input type="checkbox"/> Enable RTSP Tunnel
<input type="checkbox"/> Drop extra data from server	<input checked="" type="checkbox"/> HTTP Weblogging	<input type="checkbox"/> Persistent ETag
<input type="checkbox"/> Adaptive Timeout		

Type a name for the HTTP profile, for example, `websocket_SSL`.

Go back to each **SSL load balancing service** of port 22334, for example, `srv-1-22334`. Click **+ Profiles**.

The screenshot shows the Citrix ADC VPX (1000) Configuration page for a Load Balancing Service. The 'Basic Settings' section includes the following information:

Service Name	srv-1-22334	Traffic Domain	0
Server Name	srv-1	Number of Active Connections	-
IP Address	10.63.32.55	Hash ID	-
Server State	● DOWN	Server ID	None
Protocol	SSL	Clear Text Port	-
Port	22334	Cache Type	SERVER
Comments		Cacheable	NO
Monitoring Connection Close Bit	NONE	Health Monitoring	YES
		AppFlow Logging	ENABLED

The 'Advanced Settings' sidebar on the right includes the following options:

- + Thresholds & Timeouts
- + Profiles (highlighted with a red box)
- + Policies
- + SSL Profile
- + SSL Policies
- + Certificate

Select the HTTP profile, for example, `websocket_SSL`, and click **OK** and then **Done**.

The 'Profiles' configuration dialog shows the following settings:

- Net Profile: [Empty dropdown]
- TCP Profile: [Empty dropdown]
- HTTP Profile: `websocket_SSL` (highlighted with a black box)
- DNS Profile Name: [Empty dropdown]

Buttons: **OK** (blue), **Done** (grey)

7. (Required only when you are using the WebSocket server Version 2.0) Add an HTTP profile for each **SSL load balancing service** of port 443.
8. Create a host record for the Citrix ADC VIP address on the domain controller.

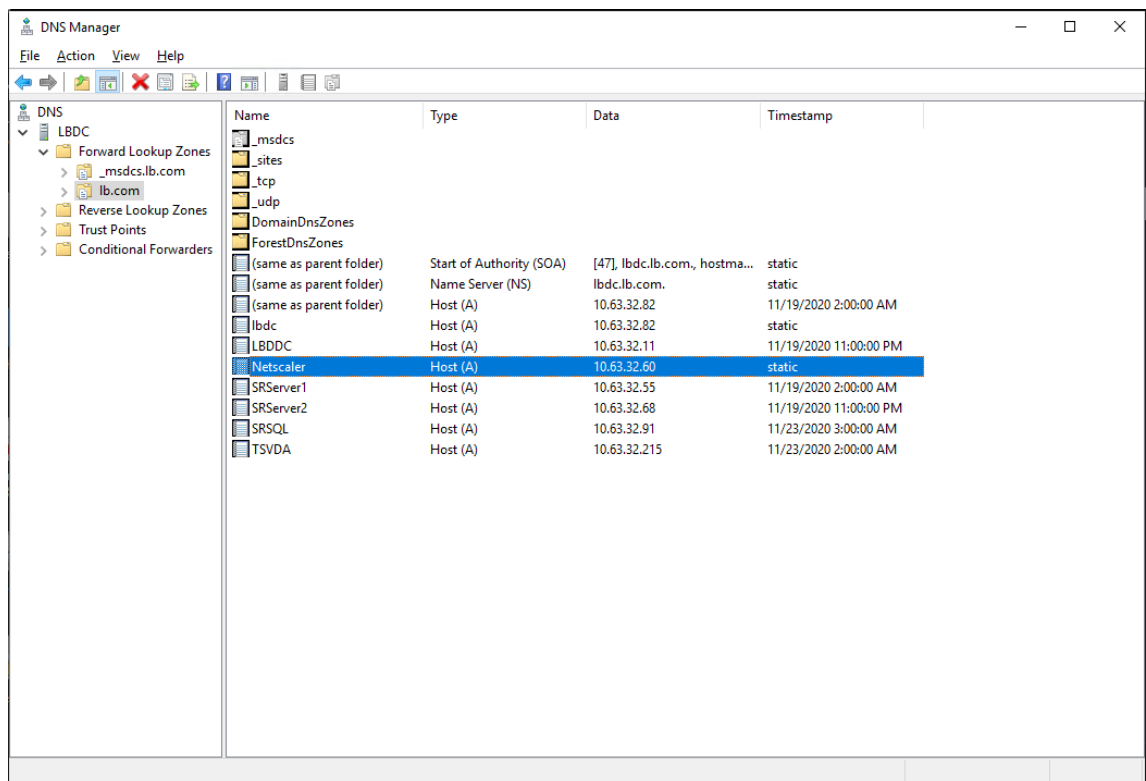

9. Add **load balancing virtual servers**.

Add the following **load balancing virtual servers** with the Citrix ADC VIP address.

- (Required only when you are using the WebSocket server Version 1.0) **load balancing virtual server** of port 22334 based on SSL
- **load balancing virtual server** of port 443 based on SSL
- **load balancing virtual server** of port 1801 based on TCP

For example, see the following screen capture.

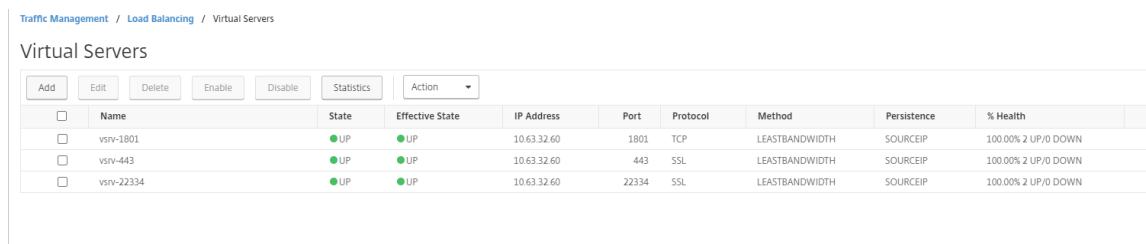

Navigate to **Traffic Management > Load Balancing > Virtual Servers** and click **Add**.

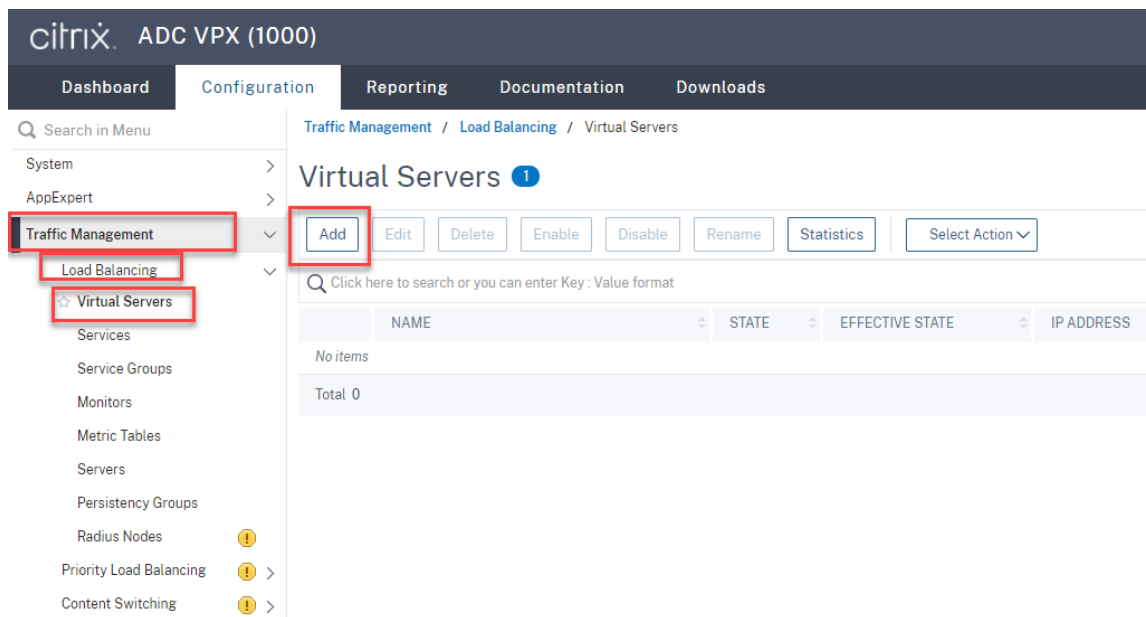

Add each virtual server with the Citrix ADC VIP address. Type a server name, select **TCP** or **SSL**, and select the relevant port number as described earlier.

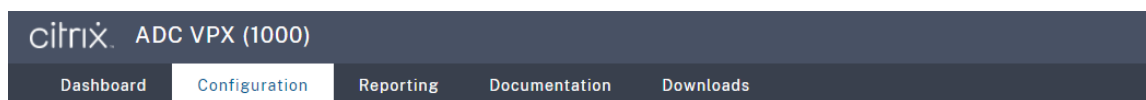

← Load Balancing Virtual Server

Bind each virtual server to the **load balancing service** of the same port. For example:

The screenshot shows the Citrix ADC VPX (1000) configuration interface. The main panel is titled 'Load Balancing Virtual Server' and shows the following settings:

- Name: vsrv-443
- Protocol: **SSL** (highlighted with a red box)
- State: **DOWN** (indicated by a red dot)
- IP Address: 10.63.32.60
- Port: 443
- Traffic Domain: 0

The sidebar on the right is titled 'Service Binding / Service' and shows a list of services. The service 'srv-1-443' is selected, indicated by a checked checkbox and a red box around the row.

<input type="checkbox"/>	NAME
<input type="checkbox"/>	srv-1-22334
<input checked="" type="checkbox"/>	srv-1-443
<input type="checkbox"/>	srv-1-1801

Total 3

Tip:

The **load balancing service** of port 22334 is required only when you are using the Web-Socket server Version 1.0.

Choose a load balancing method.

Method

Method is a load balancing algorithm that the Citrix ADC uses to s

Load Balancing Method*

LEASTBANDWIDTH ⓘ

New Service Startup Request Rate

0

Backup LB Method*

ROUNDROBIN

New Service Request unit*

PER_SECOND

Increment Interval

Configure persistence on each virtual server. We recommend you select **SOURCEIP** as the persistence type. For more information, see [Persistence settings](#).

Persistence

Configure persistence to route all connections from the same user primary persistence type fails.

Select Persistence Type*

SOURCEIP
 OTHERS
 (i)

Time-out (mins)*

(i)

IPv4 Netmask

IPv6 Mask Length

OK

(Required only when you are using the WebSocket server Version 1.0) Add an HTTP profile for the load balancing virtual server of port 22334.

Profiles x

A profile is a collection of settings that can be applied to a NetScaler entity, such as a virtual server or service. You can apply the same profile to multiple entities of the same type.

<p>Net Profile <input type="text" value=""/> + / ✎</p> <p>TCP Profile <input type="text" value=""/> + / ✎</p> <p>LB Profile <input type="text" value=""/> + / ✎</p>	<p>HTTP Profile <input type="text" value="websocket_ssl"/> + / ✎ (i)</p> <p>DB Profile <input type="text" value=""/> + / ✎</p> <p>DNS Profile Name <input type="text" value=""/> + / ✎</p>
--	---

OK

10. Install a Subject Alternative Name (SAN) certificate in Citrix ADC.

Obtain a SAN certificate in PEM format from a trusted Certificate Authority (CA). Extract and upload the certificate and private key files in Citrix ADC by navigating to **Traffic Management > SSL > Server Certificate Wizard**.

For more information, see [SSL certificates](#).

4 Install Certificate

Certificate-Key Pair Name*

Certificate File Name*
 ?

Key File Name*
 ?

Password*
 ?

Notify When Expires

No SNMP Trap destination found. Notification will not be sent until a trap destination is configured.

Notification Period

11. Bind a SAN certificate to each SSL load balancing virtual server.

Navigate to **Traffic Management > Load Balancing > Virtual Servers**, select an SSL load balancing virtual server, and click **Server Certificate**.

The screenshot shows the Citrix ADC VPX (1000) configuration interface. The top navigation bar includes 'Dashboard', 'Configuration', 'Reporting', 'Documentation', and 'Downloads'. The main heading is 'Load Balancing Virtual Server' with a back arrow icon. Below the heading, there is a link for 'Export as a Template'. The configuration is organized into sections: 'Basic Settings', 'Services and Service Groups', and 'Certificate'. The 'Basic Settings' section lists: Name (vsrv-443), Protocol (SSL), State (DOWN with a red dot), IP Address (10.63.32.60), Port (443), and Traffic Domain (0). The 'Services and Service Groups' section shows '1 Load Balancing Virtual Server Service Binding' and 'No Load Balancing Virtual Server ServiceGroup Binding'. The 'Certificate' section shows 'No Server Certificate' (highlighted with a red box) and 'No CA Certificate'. A blue 'Continue' button is located at the bottom of the configuration area.

Basic Settings	
Name	vsrv-443
Protocol	SSL
State	● DOWN
IP Address	10.63.32.60
Port	443
Traffic Domain	0

Services and Service Groups	
1	Load Balancing Virtual Server Service Binding
No	Load Balancing Virtual Server ServiceGroup Binding

Certificate	
No	Server Certificate
No	CA Certificate

[Continue](#)

Add the previously mentioned SAN certificate and click **Bind**.

Step 4: Configure an existing Session Recording agent to support load balancing

1. Log on to the Session Recording agent by using a domain administrator account.
2. Open **Session Recording Agent Properties**.
3. Complete this step if you use Microsoft Message Queuing (MSMQ) over TCP.

Type the FQDN of your Citrix ADC VIP address in the **Session Recording Server** box.

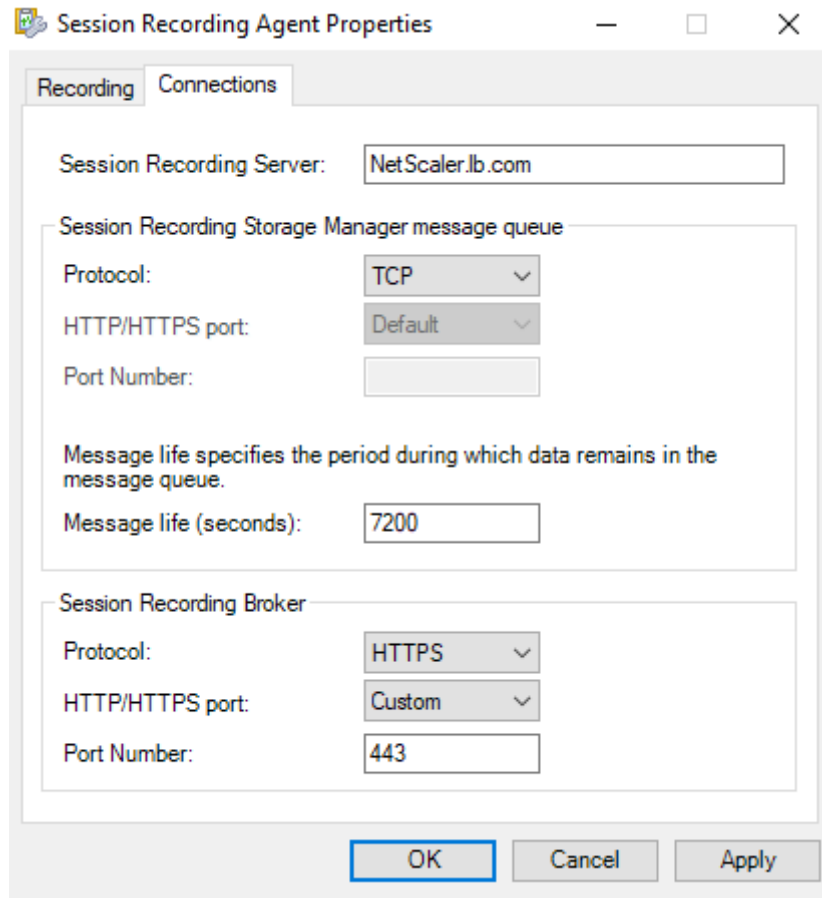

On each Session Recording server, add and set the `IgnoreOSNameValidation` DWORD value to 1 under `HKEY_LOCAL_MACHINE\SOFTWARE\Microsoft\MSMQ\Parameters`.

4. Complete this step if you use MSMQ over HTTP or HTTPS.

(Skip if this step is done) Create a host record for the Citrix ADC VIP address on the domain controller.

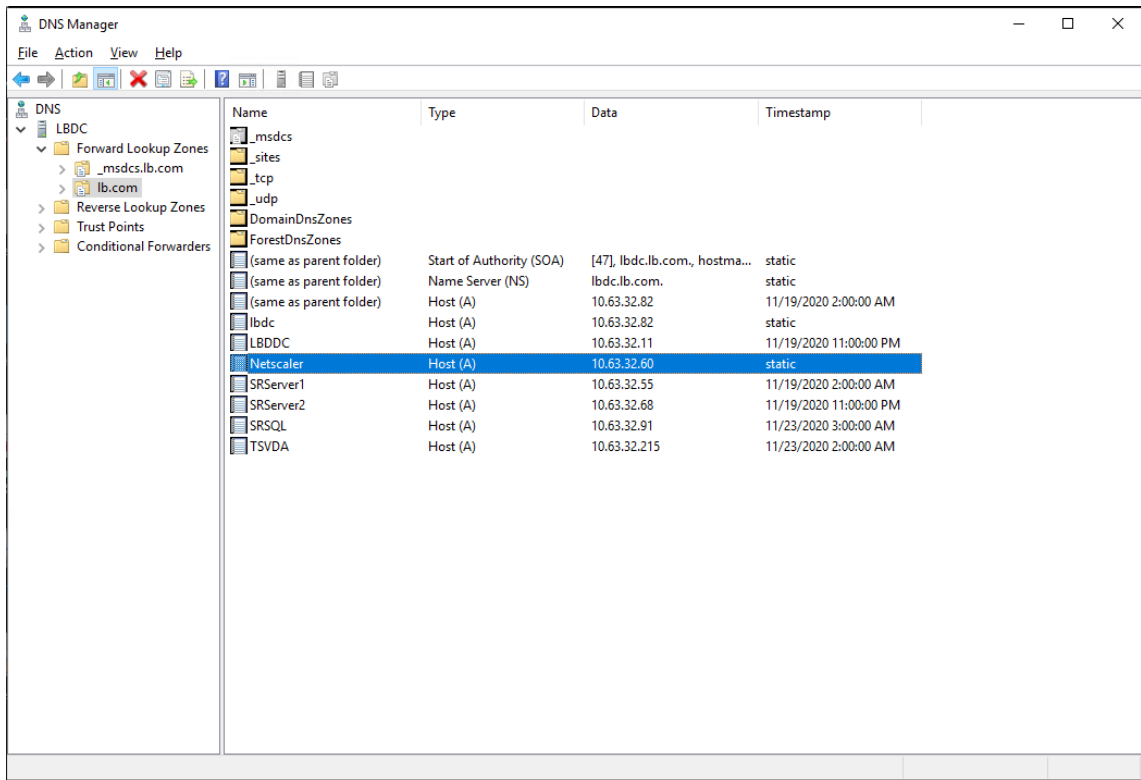

On each Session Recording server, run the `powershell.exe -file SrServerConfigurationSync.ps1 -Action AddRedirection - ADCHost <ADCHost>` command to add redirections from Citrix ADC to the local host. <ADCHost> is the FQDN of the Citrix ADC VIP address. A redirection file, for example, `sr_lb_map.xml` is generated under `C:\Windows\System32\msmq\Mapping`.

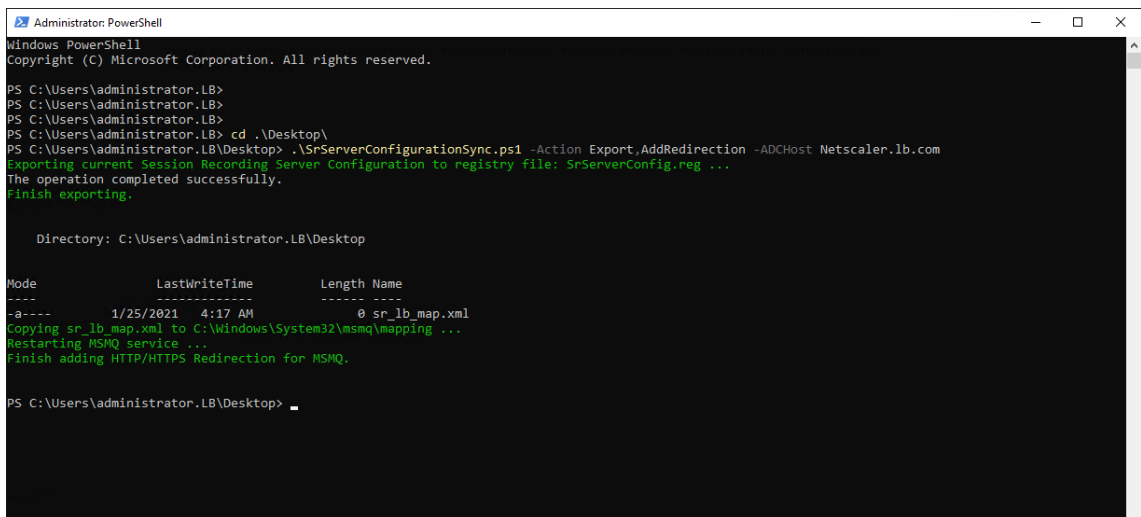

Note: Change to the folder where `SrServerConfigurationSync.ps1` resides when you run PowerShell.exe.

Type the FQDN of your Citrix ADC VIP address in the **Session Recording Server** box. For exam-

ple:

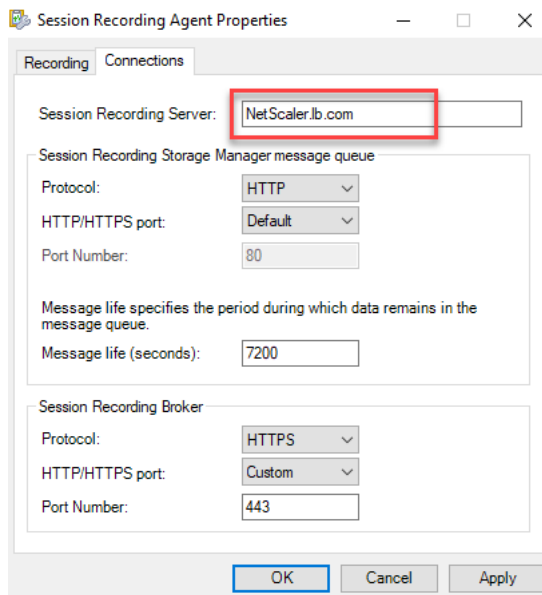

Step 5: Configure an existing Session Recording player to support load balancing

On each machine where you installed the Session Recording player component, add the Citrix ADC VIP address or its FQDN as the connected Session Recording server.

Step 6: Check whether load balancing works for the configured, existing Session Recording server

1. Launch a Citrix virtual session.
2. Check whether the session can be recorded.
3. Check whether the web player and the Session Recording player can play back the recording file.

Step 7: Add more Session Recording servers

1. Prepare a machine in the same domain and install the Session Recording server, database, and administrator logging modules on the machine.

Note:

The Session Recording administrator logging is an optional subfeature of the Session Recording server. Select the Session Recording server before you can select the Session Recording administrator logging. The Session Recording database is a mandatory subfea-

ture of the Session Recording server. When the Session Recording server is selected for installation, the Session Recording database is also selected automatically and cannot be unselected.

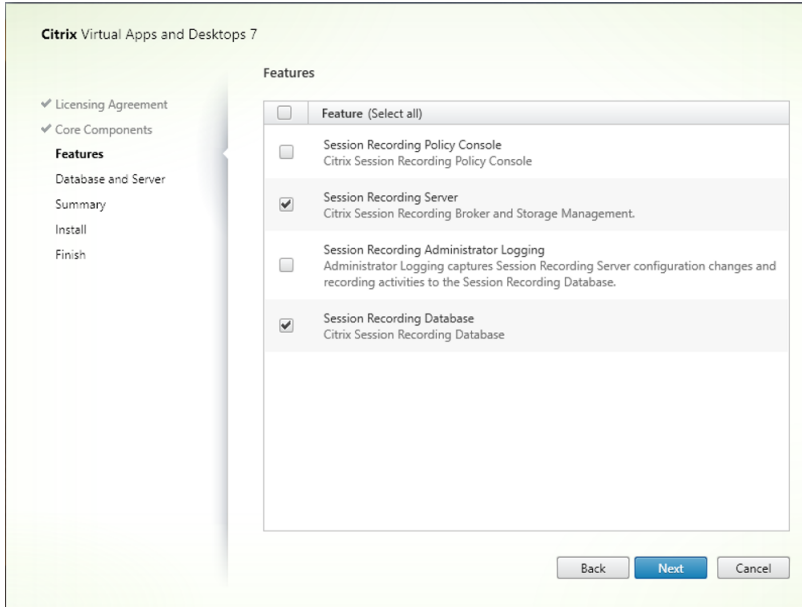

2. Use the same database names as the existing Session Recording server. For example:

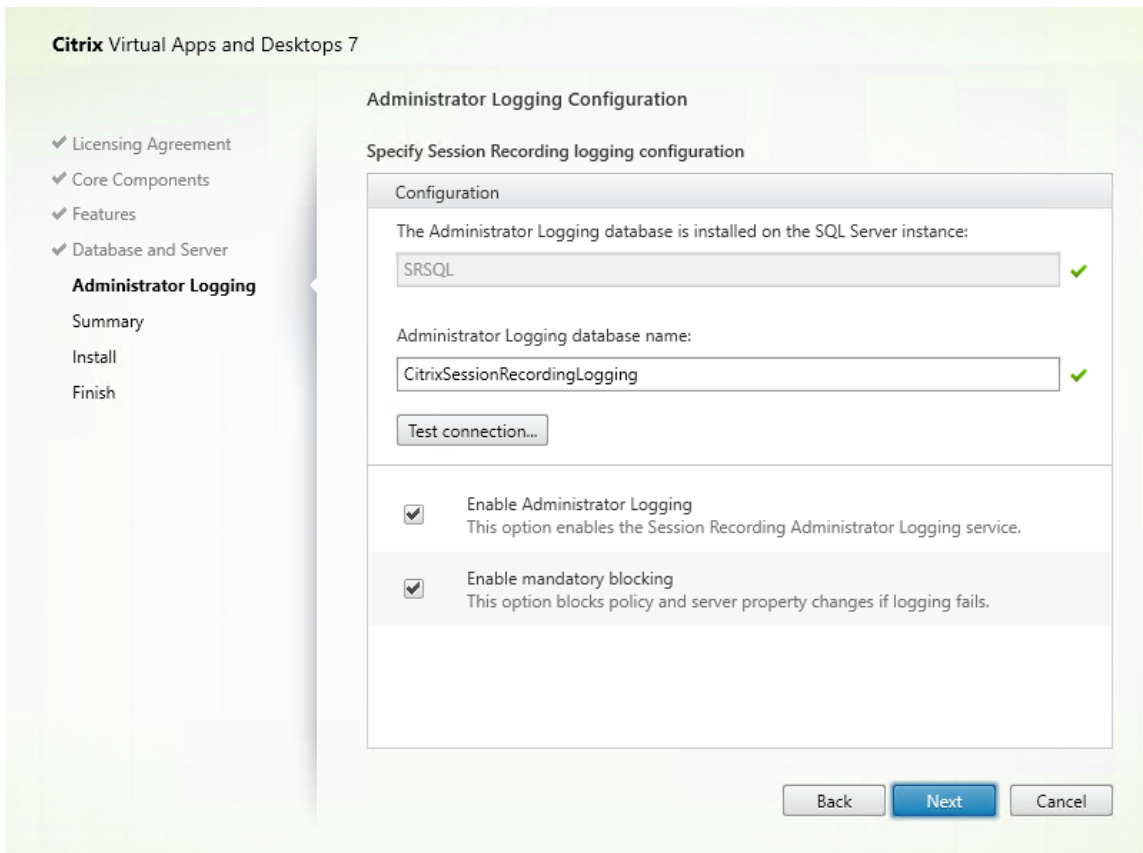

3. Disable the network firewall on the machine.
4. On the SQL Server where you installed the Session Recording database, add all the Session Recording server machine accounts to the shared Session Recording database and assign them with the `db_owner` permission. For example:

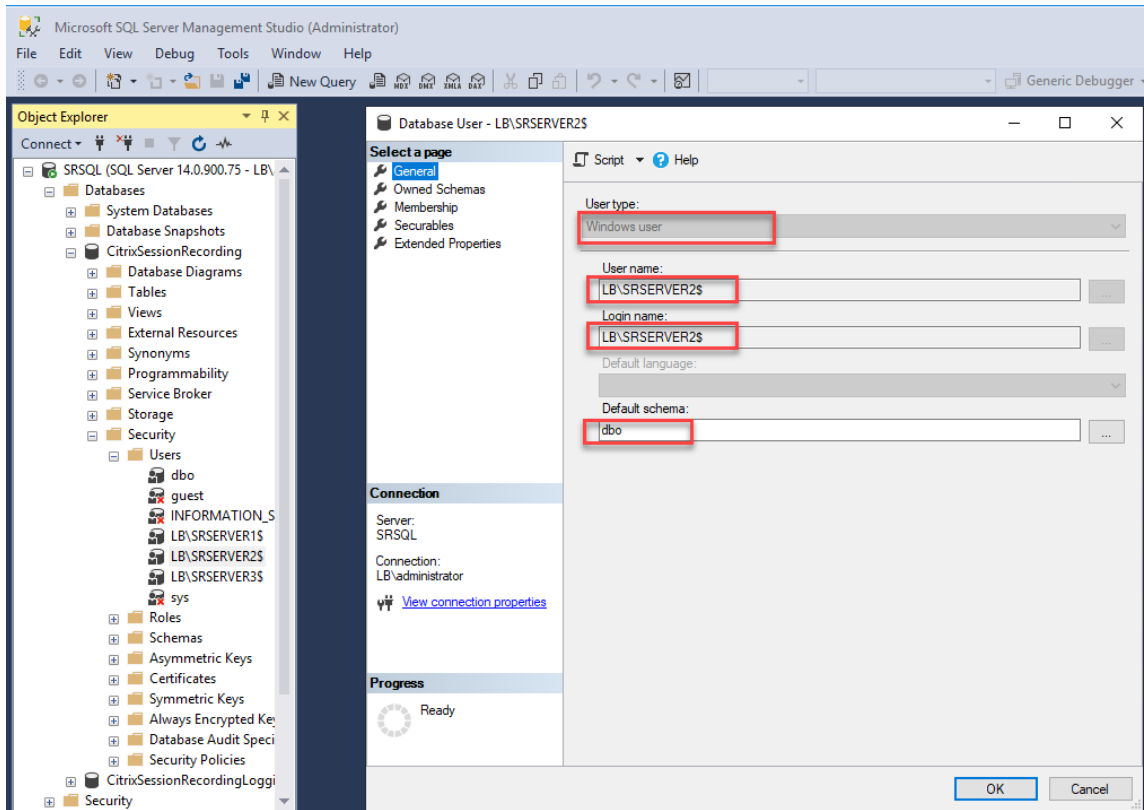

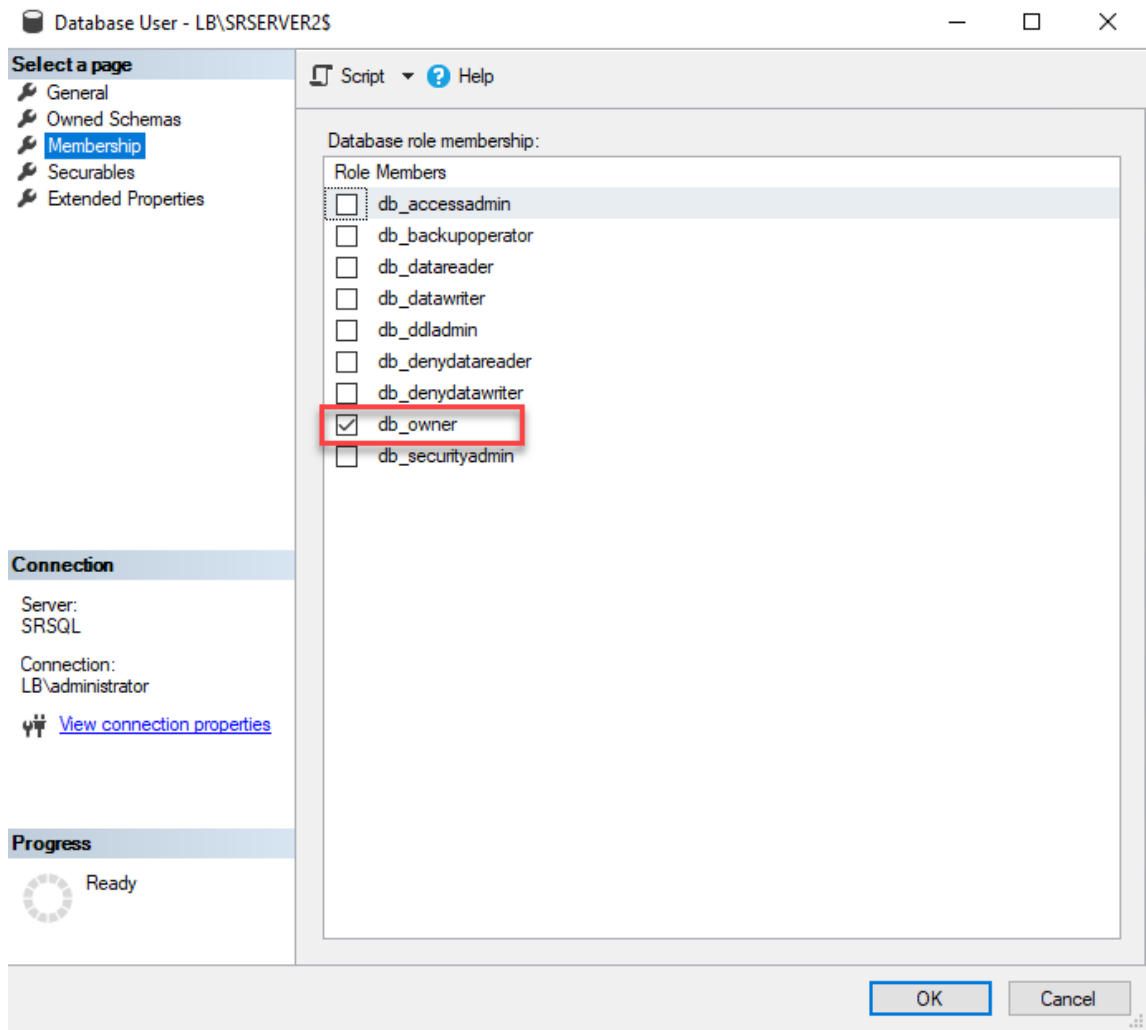

5. Share the Read/Write permission of the recording storage and restore folders, for example, `SessionRecording` and `SessionRecordingsRestored`, with the machine account of the new Session Recording server, for example, `LB\SRServer2$`. The dollar sign `$` is required.
6. Repeat [Step 3](#) to add **load balancing services** for the new Session Recording server and edit existing virtual servers to add bindings to the load balancing services. There is no need to add more virtual servers. For example:

citrix ADC VPX (1000)

Dashboard Configuration Reporting Documentation Downloads

Search in Menu

- System >
- AppExpert >
- Traffic Management**
 - Load Balancing
 - Virtual Servers
 - Services
 - Service Groups
 - Monitors
 - Metric Tables
 - ☆ Servers
 - Persistence Groups
 - Radius Nodes !

Traffic Management / Load Balancing / Servers

Servers 2

Add Edit Delete Rename Select Action

Click here to search or you can enter Key : Value format

<input type="checkbox"/>	NAME	STATE	IPADDRESS / DOMAIN
<input type="checkbox"/>	srv-1	● ENABLED	10.63.32.55
<input type="checkbox"/>	srv-2	● ENABLED	10.63.32.74
Total 2			

citrix ADC VPX (1000)

Dashboard Configuration Reporting Documentation Downloads

Search in Menu

- System >
- AppExpert >
- Traffic Management**
 - Load Balancing
 - Virtual Servers
 - ☆ Services
 - Service Groups
 - Monitors
 - Metric Tables
 - Servers
 - Persistence Groups
 - Radius Nodes !
 - Priority Load Balancing !
 - Content Switching !
 - Cache Redirection !
 - DNS >
 - GSLB !
 - SSL >
 - Subscriber >
 - Service Chaining >
 - User >

Traffic Management / Load Balancing / Services / Services

Services

Services 8 Auto Detected Services 0 Internal Services 6

Add Edit Delete Rename Statistics No action

Click here to search or you can enter Key : Value format

<input type="checkbox"/>	NAME	SERVER STATE	IP ADDRESS/DOMAIN NAME	PORT	PROTOCOL
<input type="checkbox"/>	srv-1-80	● UP	10.63.32.55	80	TCP
<input type="checkbox"/>	srv-1-443	● UP	10.63.32.55	443	TCP
<input type="checkbox"/>	srv-1-1801	● UP	10.63.32.55	1801	TCP
<input type="checkbox"/>	srv-1-22334	● UP	10.63.32.55	22334	TCP
<input type="checkbox"/>	srv-2-443	● UP	10.63.32.74	443	TCP
<input type="checkbox"/>	srv-2-80	● UP	10.63.32.74	80	TCP
<input type="checkbox"/>	srv-2-1801	● UP	10.63.32.74	1801	TCP
<input type="checkbox"/>	srv-2-22334	● UP	10.63.32.74	22334	TCP
Total 8					

The screenshot shows the Citrix ADC VPX (1000) configuration interface. The top navigation bar includes Dashboard, Configuration, Reporting, Documentation, and Downloads. The left sidebar shows a search menu and a tree view of configuration categories, with 'Virtual Servers' under 'Load Balancing' highlighted. The main content area is titled 'Virtual Servers' and features a toolbar with buttons for Add, Edit, Delete, Enable, Disable, Rename, Statistics, and Select Action. Below the toolbar is a search bar and a table of virtual servers. The table has columns for NAME, STATE, EFFECTIVE STATE, and IP ADDRESS. The row for 'vsrv-22334' is selected, and its checkbox is checked. The total number of servers is 4.

<input type="checkbox"/>	NAME	STATE	EFFECTIVE STATE	IP ADDRESS
<input type="checkbox"/>	vsrv-80	UP	UP	10.63.32.60
<input type="checkbox"/>	vsrv-1801	UP	UP	10.63.32.60
<input type="checkbox"/>	vsrv-443	UP	UP	10.63.32.60
<input checked="" type="checkbox"/>	vsrv-22334	UP	UP	10.63.32.60

Total 4

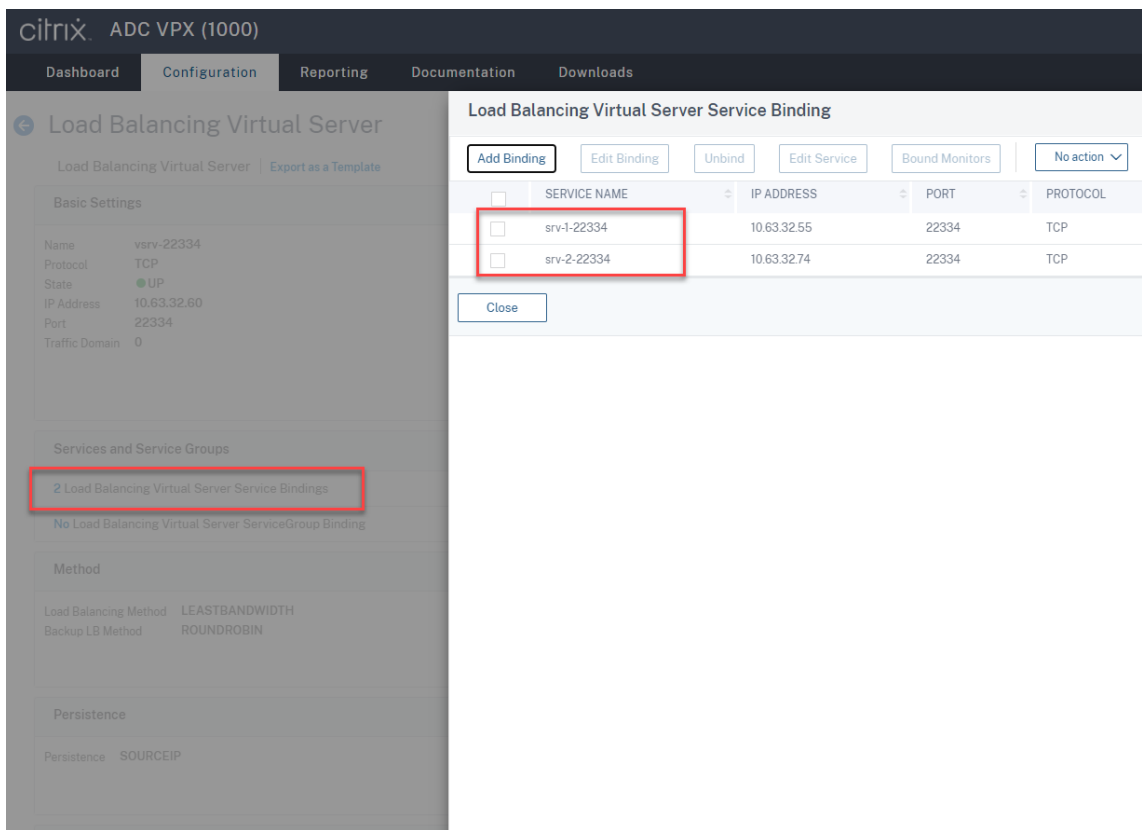

7. Copy the Session Recording Authorization Console configuration file, `SessionRecordingAzManStore.xml`, from the existing Session Recording server to the new Session Recording server. The file lives in `<Session Recording server installation path>\App_Data`.

8. To use MSMQ over HTTP or HTTPS for the new Session Recording server, complete the following steps to import the registry settings of the currently functioning Session Recording server.

On the existing Session Recording server, for example, `SRServer1`, run the `powershell.exe -file SrServerConfigurationSync.ps1 -Action Export - ADCHost <ADCHost >` command, where `<ADCHost>` is the FQDN of the Citrix ADC VIP address. An exported registry file, `SrServerConfig.reg`, is generated.

Copy the `SrServerConfig.reg` file to the new Session Recording server and run the `powershell.exe -file SrServerConfigurationSync.ps1 -Action Import ,AddRedirection - ADCHost <ADCHost>` command. The **EnableLB** value is added to the registry key of the new Session Recording server at `HKEY_LOCAL_MACHINE\SOFTWARE\Citrix\SmartAuditor\Server` and a `sr_lb_map.xml` file is added under `C:\Windows\System32\msmq\Mapping`.

9. Repeat the procedure to add another Session Recording server.

Troubleshoot

- Sessions are not recording when you use a CNAME record or an ALIAS record for a Session Recording server. To address this issue, see the [Microsoft documentation](#).
- Recording files can be stored locally but cannot be stored in a Universal Naming Convention (UNC) path. To address this issue, change the start mode of the Citrix Session Recording Storage Manager service to **Automatic (Delayed Start)**.

Deploy and load balance Session Recording in Azure

December 3, 2024

Prerequisites

- You already have Citrix Virtual Apps and Desktops or Citrix DaaS (formerly Citrix Virtual Apps and Desktops service) installed in Azure.
- You have an Azure account.

Step 1: Upload the Citrix Virtual Apps and Desktops installer to Azure

Note:

Skip Step 1 if you use your Citrix account credentials to access the Citrix Virtual Apps and Desktops download page and download the product ISO file to a VM in Azure.

1. In the [Azure portal](#), create a **general-purpose v2** storage account and accept the default performance tier, **Standard**.

All access to Azure Storage goes through a storage account.

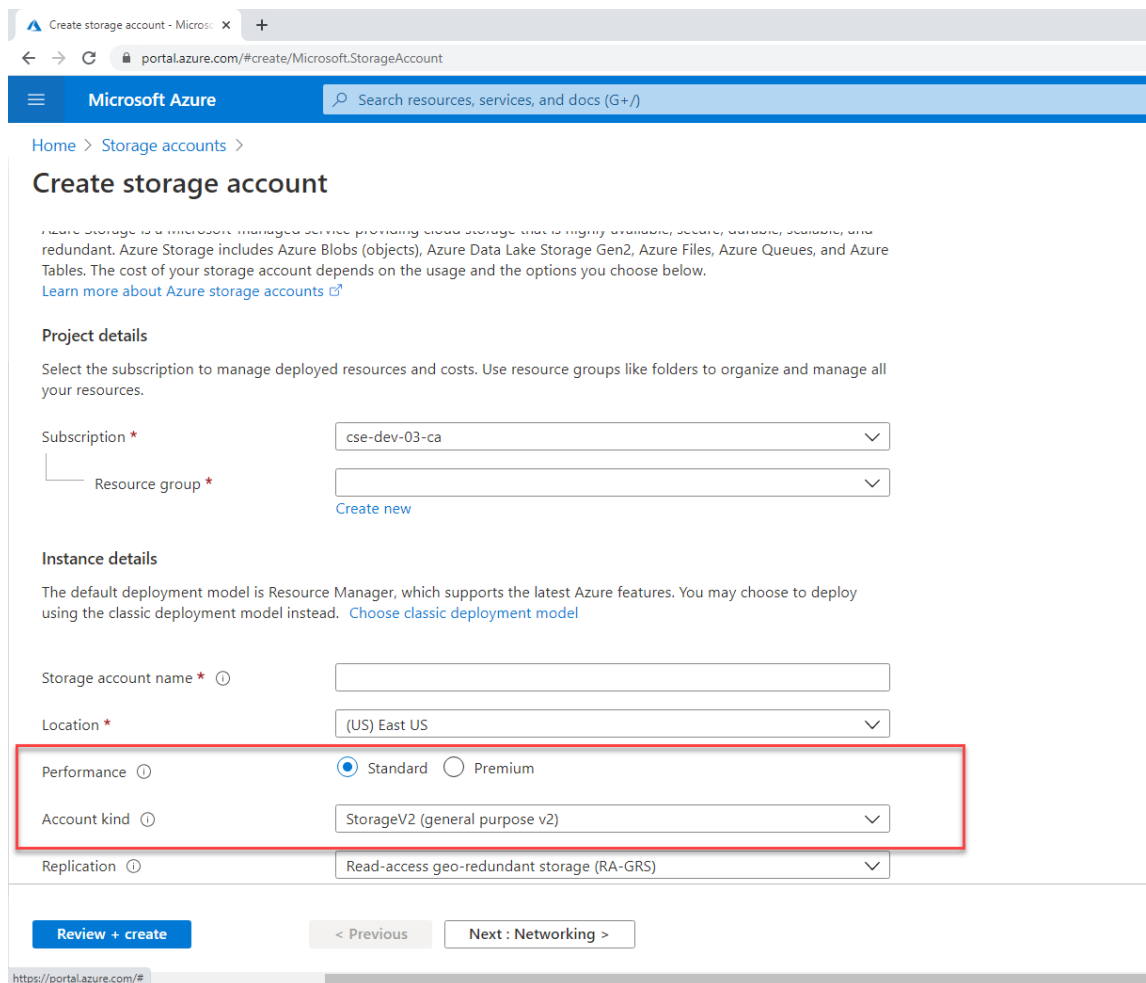

2. Navigate to your new storage account and select **Containers** in the **Blob service** section to create a container.

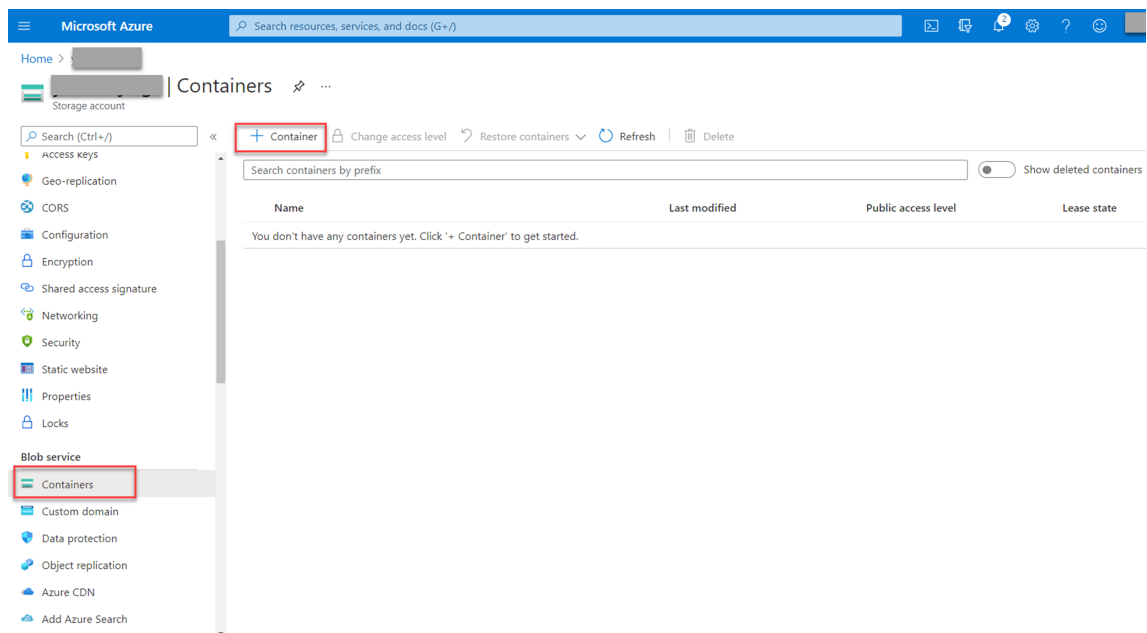

3. Upload the Citrix Virtual Apps and Desktops installer to the container.

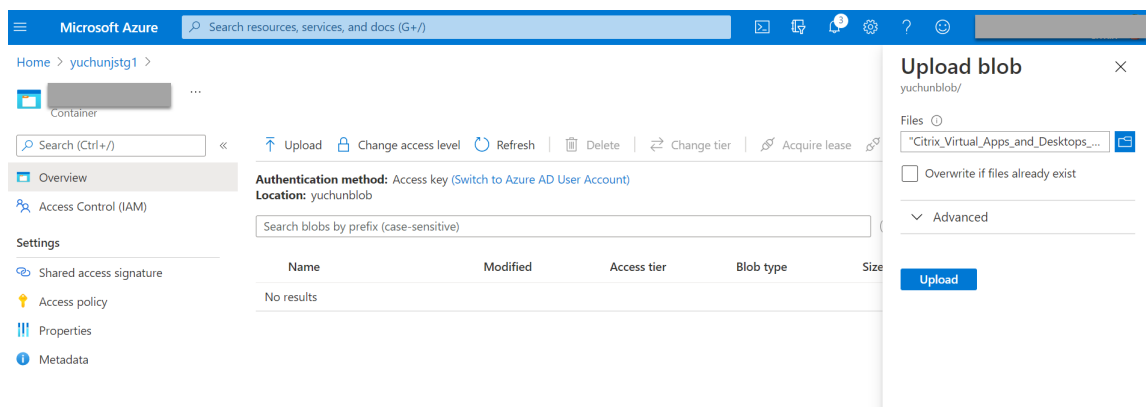

Step 2: Create a SQL managed instance in the Azure portal

For more information, see [Create an Azure SQL Managed Instance](#).

Step 3: Create Azure virtual machines (VMs)

Choose **Windows Server 2019 Datacenter –Gen1** for the image and **Standard_D4as_v4 –4 vcpus, 16GiB memory** for the size. For more information, see [Create a Windows virtual machine in the Azure portal](#).

portal.azure.com/#create/Microsoft.VirtualMachine

Microsoft Azure Search resources, services, and docs (G+/)

All services > Virtual machines >

Create a virtual machine

Select the subscription to manage deployed resources and costs. Use resource groups like folders to organize and manage all your resources.

Subscription * ⓘ

Resource group * ⓘ
[Create new](#)

Instance details

Virtual machine name * ⓘ

Region * ⓘ

Availability options ⓘ

Image * ⓘ
[See all images](#)

Azure Spot instance ⓘ

Size * ⓘ
[See all sizes](#)

Administrator account

Username * ⓘ

[Review + create](#) [< Previous](#) [Next : Disks >](#)

Step 4: Remote desktop and download the Citrix Virtual Apps and Desktops installer to the Azure VMs

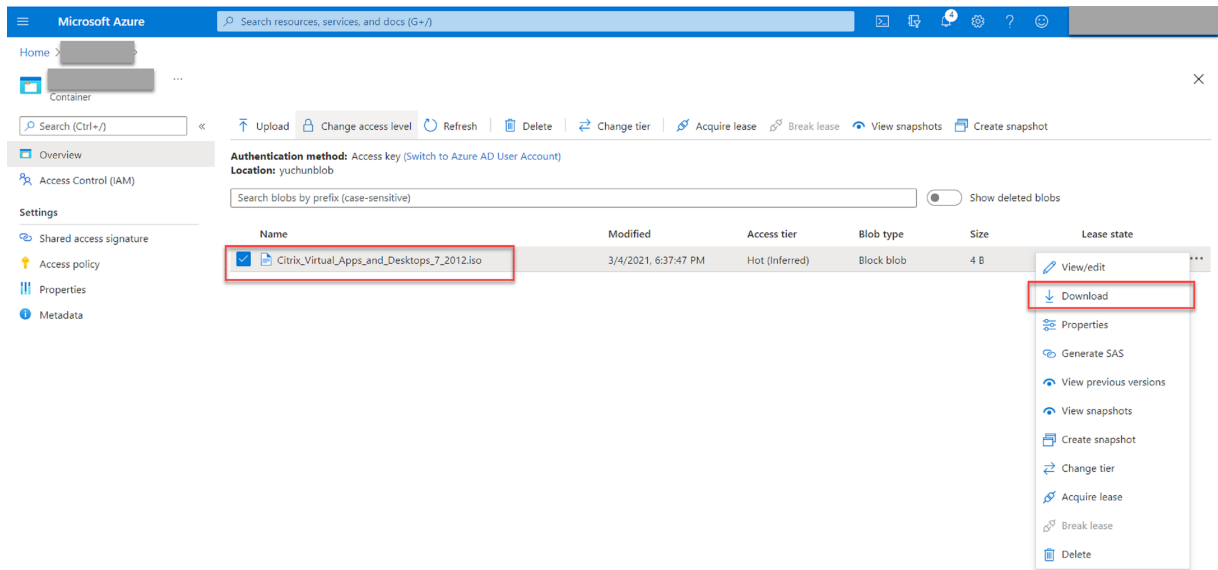

Step 5: Run the installer to install Session Recording components on the Azure VMs

For more information, see [Install the Session Recording Administration components](#).

Step 6: Configure an Azure file share to store recordings

To create an Azure file share to store recordings, complete the following steps:

1. In the [Azure portal](#), create a storage account and then create an Azure file share.

For a quick start guide, see [Create and manage Azure file shares with the Azure portal](#). The following table recommends configurations for your consideration.

Recording File Size MB/hour	Number of Recorded Sessions Per Day	File Share Type	File Share Quota (TB)	Session Recording Server Quantity	Session Recording Server Size
< 6.37	< 1,000	HDD Standard (StorageV2)	2	1	Standard D4as_v4
< 6.37	1,000–2,000	SSD Premium	3	1	Standard D4as_v4

Recording File Size MB/hour	Number of Recorded Sessions Per Day	File Share Type	File Share Quota (TB)	Session Recording Server Quantity	Session Recording Server Size
< 6.37	2,000–3,000	SSD Premium	5	1	Standard D4as_v4
< 6.37	3,000–4,000	SSD Premium	6	1	Standard D4as_v4
Approx.10	< 1,000	HDD Standard (StorageV2)	3	1	Standard D4as_v4
Approx.10	1,000–2,500	SSD Premium	6	1	Standard D4as_v4
Approx.10	2,500–4,000	SSD Premium	10	2	Standard D4as_v4

The file share quota is calculated based on eight hours per day, 23 working days per month, and a one-month retention period for each recording file.

2. Add the Azure file share credentials to the host where you installed the Session Recording server.
 - a) Start a command prompt as an administrator and change the drive to the **<Session Recording server installation path>\Bin** folder.

By default, the Session Recording server is installed in `C:\Program Files\Citrix\SessionRecording\Server`.

- b) Run the **SsRecUtils.exe -AddAzureFiles <storageAccountName> <fileShareName> <accesskey>** command.

Where,

- **<storageaccountname>** is the name of your storage account in Azure.
- **<filesharename>** is the name of the file share contained within your storage account.
- **<accesskey>** is your storage account key that can be used to access the file share.

There are two ways to obtain your storage account key:

- You can obtain your storage account key from the connection string that appears when you click the **Connect** icon in your file share page.

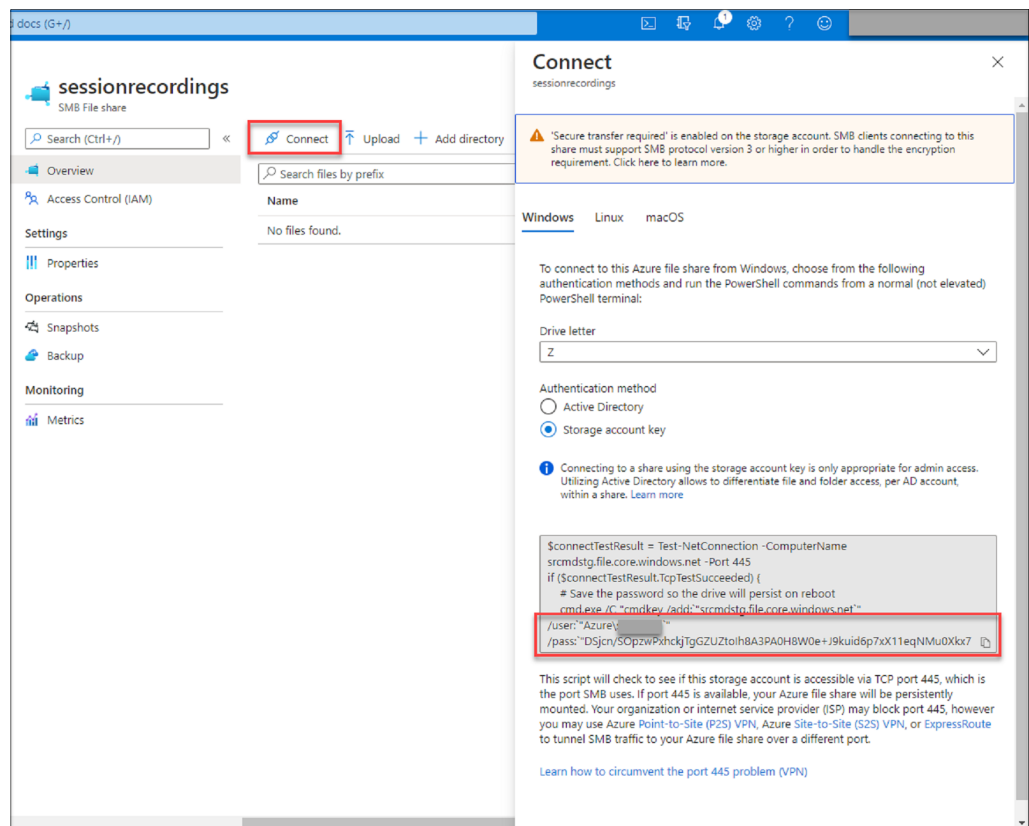

- You can also obtain your storage account key by clicking **Access keys** in the left navigation of your storage account page.

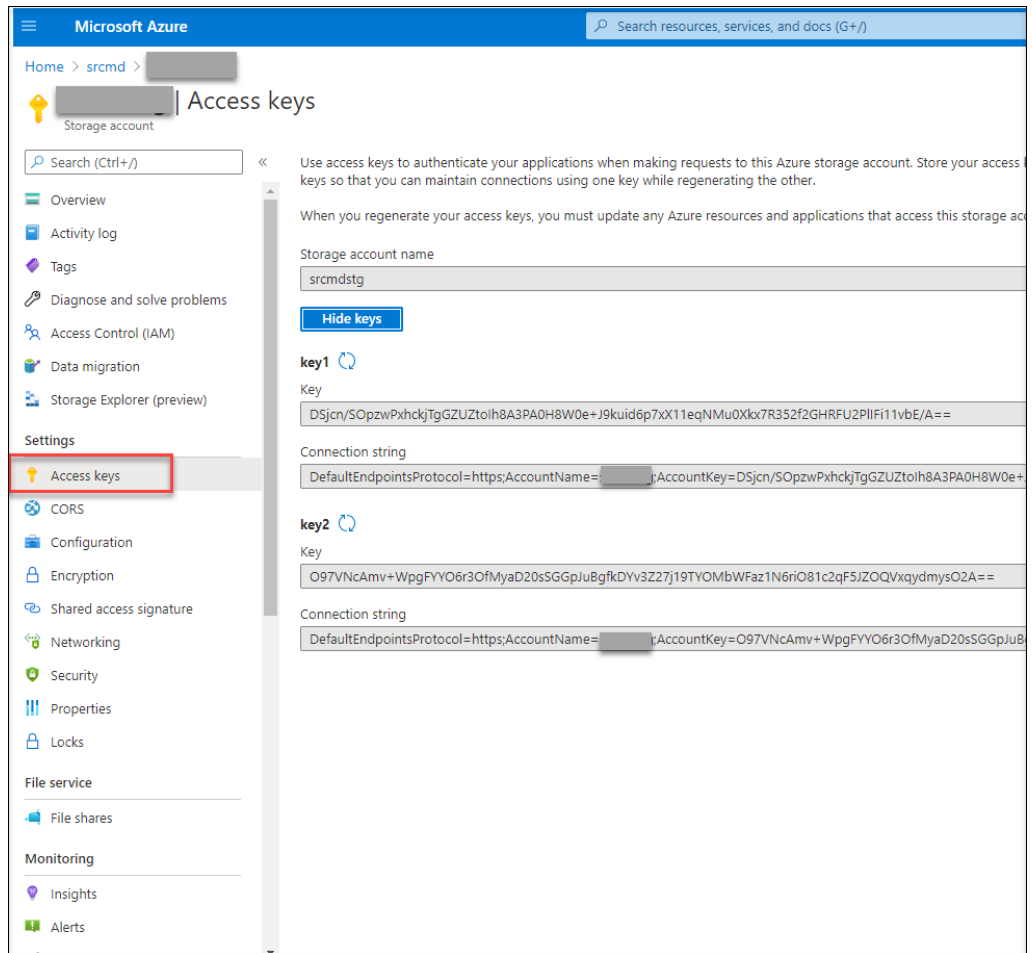

- c) Mount the Azure file share to the host where you installed the Session Recording server.
 - i. Open **Session Recording Server Properties**.
 - ii. Click **Add** on the **Storage** tab.
 - iii. Enter the UNC path in the format of `\\<storageaccountname>.file.core.windows.net\<fileshare>`.
Specify a subfolder under the file share to store your recording files. The Session Recording server then automatically creates the subfolder for you.

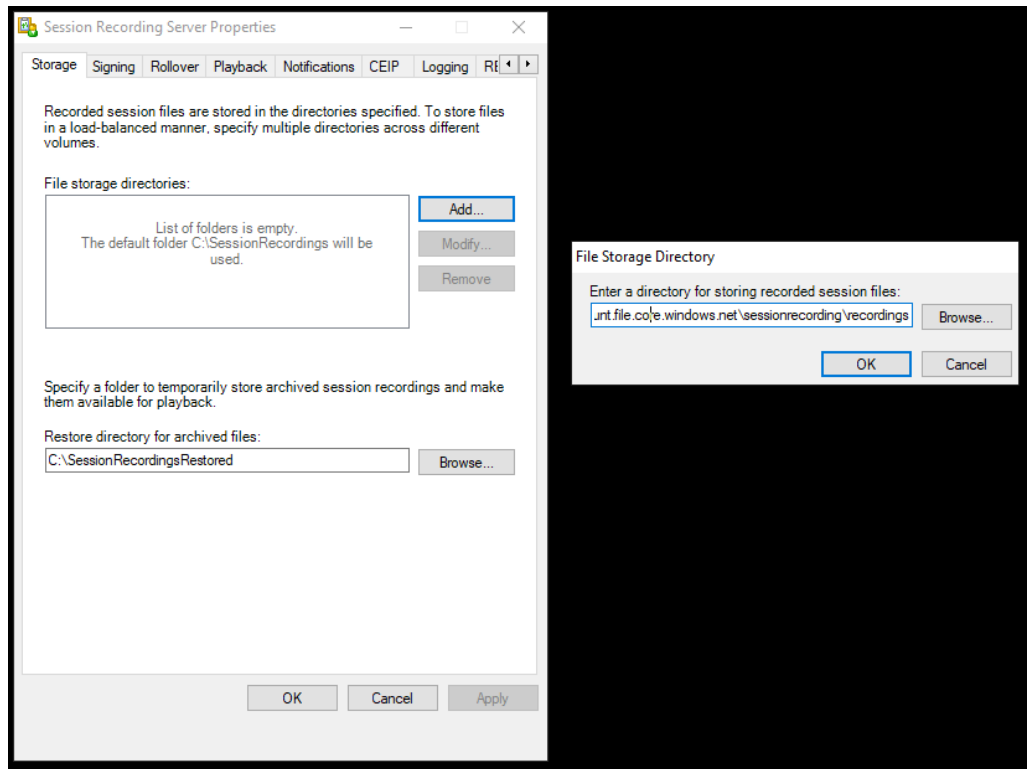

- iv. Click **OK** in the **File Storage Directory** dialog box.
- v. Click **Apply** in the **Session Recording Server Properties** window.
- vi. Click **OK** after **Apply** becomes grayed out.
- vii. Click **Yes** when you are prompted to restart the Session Recording Storage Manager service.

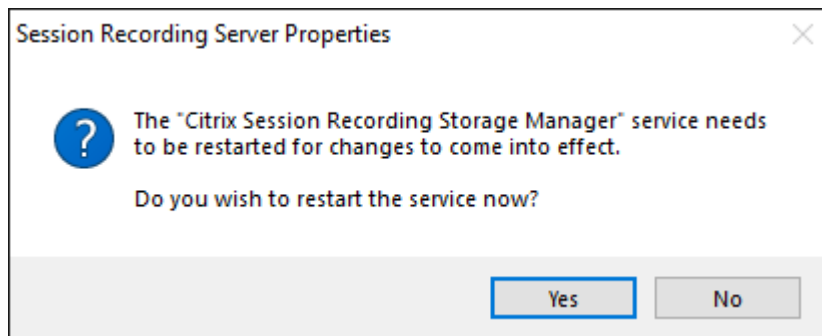

Step 7: Add a load balancer

If there is more than one Session Recording server, we recommend you add a load balancer in front of them. Azure offers many options to load-balance traffic requests. This section walks you through the process of creating Citrix ADC, Azure Load Balancer, and Azure Application Gateway in Azure.

Option 1: Create a Citrix ADC VPX instance in Azure

1. In the [Azure portal](#), type Citrix ADC in the search box.

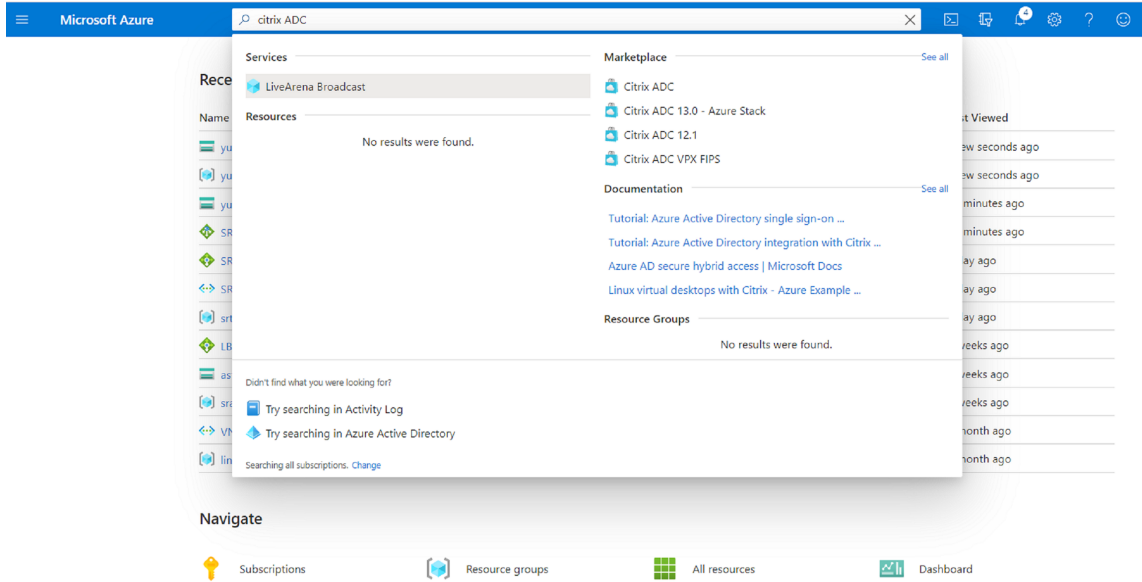

2. Choose the **Citrix ADC VPX Bring Your Own License** plan and then click **Create**.

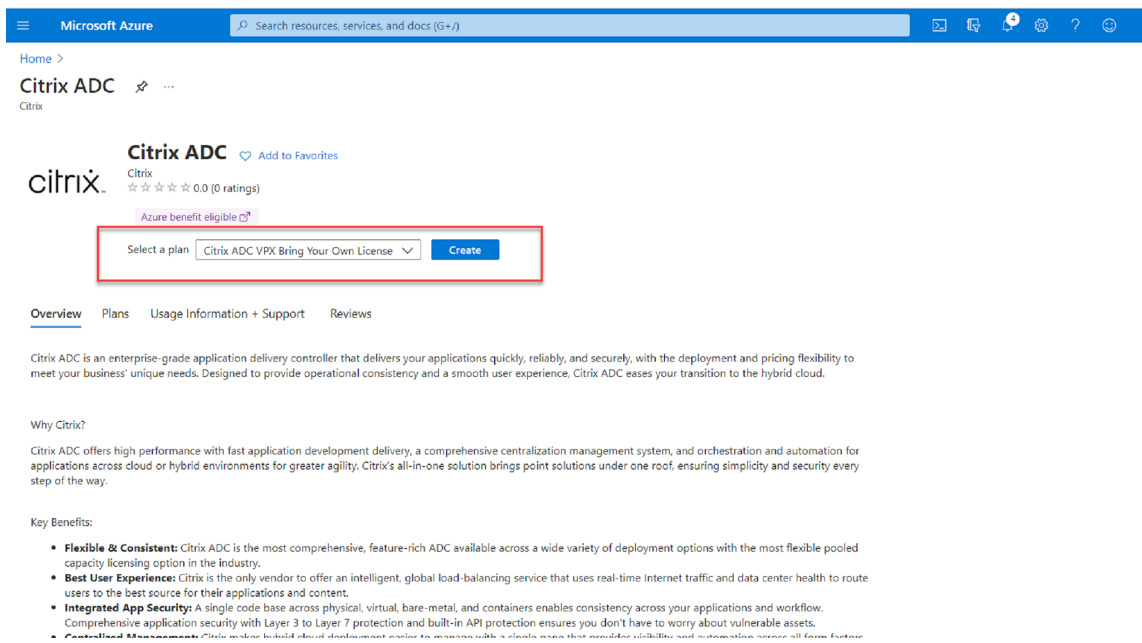

3. Select or create a resource group and set the other settings on the **Basics** tab.
4. Set VM configurations.

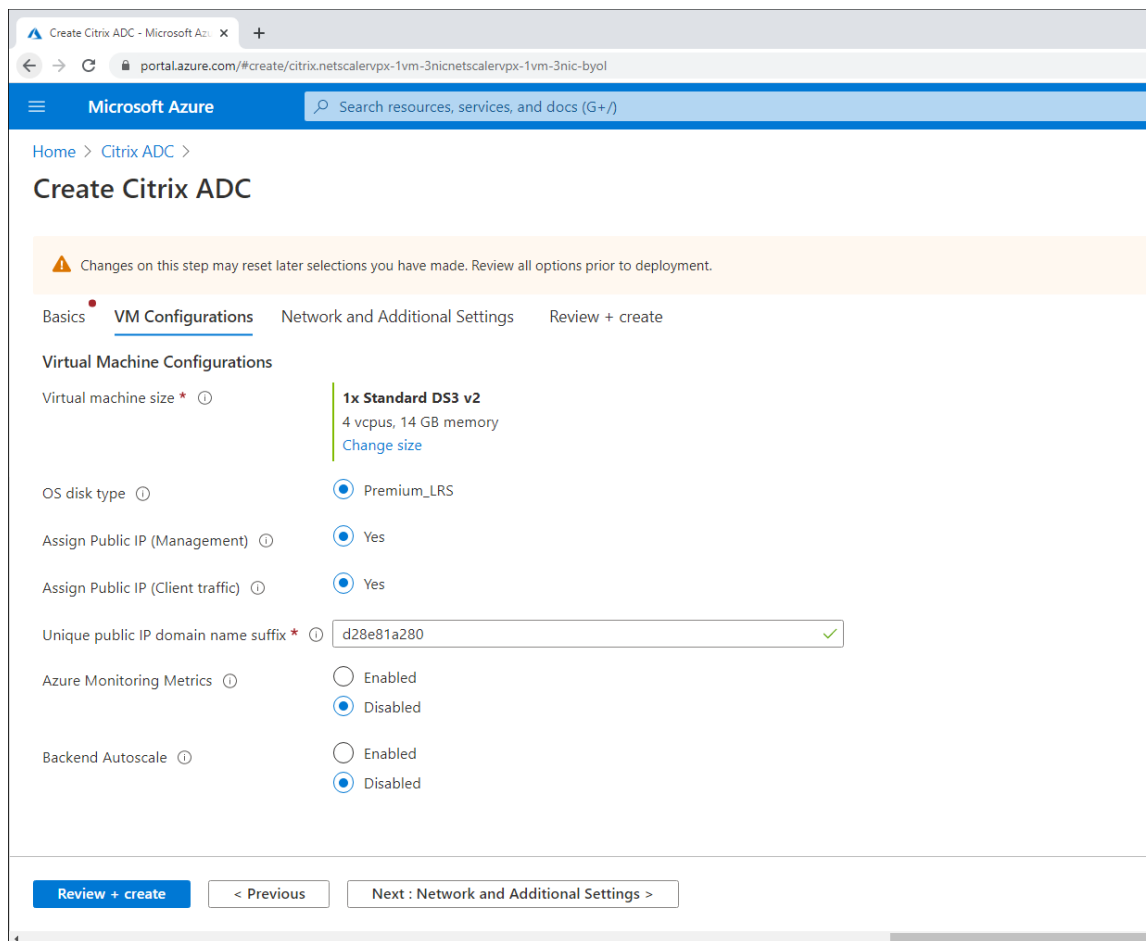

5. Check and modify network settings if necessary. Choose **ssh (22)**, **http (80)**, **https (443)** for public inbound ports.

A virtual network is automatically created. If you already have a Session Recording environment installed, you can use its virtual network and server subnet settings.

Microsoft Azure Search resources, services, and docs (G+)

Home > Citrix ADC >

Create Citrix ADC

Configure virtual networks

Virtual network * ⓘ (new) citrix-adc-vpx-virtual-network ▼
[Create new](#)

Management Subnet * ⓘ (new) 01-management-subnet (10.128.0/24) ▼

Client Subnet * ⓘ (new) 11-client-subnet (10.129.0/24) ▼

Server Subnet * ⓘ (new) 12-server-subnet (10.130.0/24) ▼

Public IP (Management)

Management Public IP (NSIP) * ⓘ (new) citrix-adc-vpx-nsip ▼
[Create new](#)

Management Domain Name ⓘ citrix-adc-vpx-nsip-23f12ee6b2 ✓
.eastus.cloudapp.azure.com

Public IP (Clientside)

Clientside Public IP (VIP) * ⓘ (new) citrix-adc-vpx-vip ▼
[Create new](#)

Clientside Domain Name ⓘ citrix-adc-vpx-vip-23f12ee6b2 ✓
.eastus.cloudapp.azure.com

Public Inbound Ports (Management only)

Ports open for Management public IP ⓘ None
 ssh (22)
 ssh (22), http (80), https (443)

Review + create < Previous Next : Review + create >

☰ Microsoft Azure
🔍 Search resources, services, and docs

Home > Citrix ADC >

Create Citrix ADC

Basics
VM Configurations
Network and Additional Settings
Review + create

Boot diagnostics

Diagnostics storage account * ⓘ (new) citrixadcpxe42b4be259 ▼
[Create New](#)

Network Settings

Configure virtual networks

Virtual network * ⓘ (new) citrix-adc-vpx-virtual-network ▼
[Create new](#)

Management Subnet * ⓘ (new) 01-management-subnet (10.1.32.0/24) ▼

Client Subnet * ⓘ (new) 11-client-subnet (10.1.33.0/24) ▼

Server Subnet * ⓘ (new) 12-server-subnet (10.1.34.0/24) ▼

Accelerated Networking

Accelerated Networking (Management Interface) ⓘ On Off

Accelerated Networking (Client Interface) ⓘ On Off

Accelerated Networking (Server Interface) ⓘ On Off

Public IP (Management)

Management Public IP (NSIP) * ⓘ (new) citrix-adc-vpx-nsip ▼
[Create new](#)

Review + create

< Previous

Next : Review + create >

6. Click **Next: Review + create** to create the Citrix ADC VPX instance and wait for the deployment to complete.

Microsoft Azure Search resources, services, and documentation

Home > Citrix ADC >

Create Citrix ADC

Validation Passed

Basics VM Configurations Network and Additional Settings **Review + create**

PRODUCT DETAILS

Citrix ADC
by Citrix
[Terms of use](#) | [Privacy policy](#)

TERMS

By clicking "Create", I (a) agree to the legal terms and privacy statement(s) associated with the Marketplace offering(s) listed above; (b) authorize Microsoft to bill my current payment method for the fees associated with the offering(s), with the same billing frequency as my Azure subscription; and (c) agree that Microsoft may share my contact, usage and transactional information with the provider(s) of the offering(s) for support, billing and other transactional activities. Microsoft does not provide rights for third-party offerings. See the [Azure Marketplace Terms](#) for additional details.

Basics

Subscription	cse-dev-03-ca
Resource group	srcmdtest
Region	East US
Citrix ADC Release Version	13.0
License Subscription	Bring Your Own License
Virtual Machine name	citrix-adc-vpx
Username	nsroot
Password	*****

VM Configurations

Create < Previous Next [Download a template for automation](#)

7. Set the subnet IP (SNIP) address and the Citrix ADC VIP address to be on the same subnet.

The SNIP address and the VIP address must be on the same subnet. In this example, we set the VIP address to be on the subnet of the SNIP address.

- a) Stop the **citrix-adc-vpx** virtual machine.
- b) Change the subnet of the VIP address.

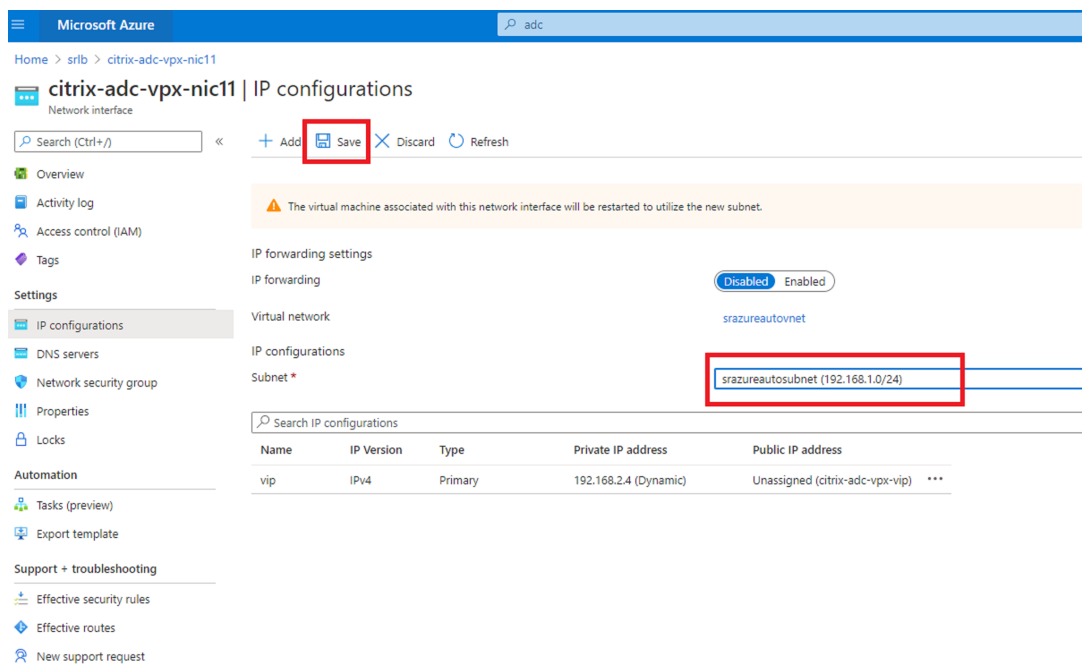
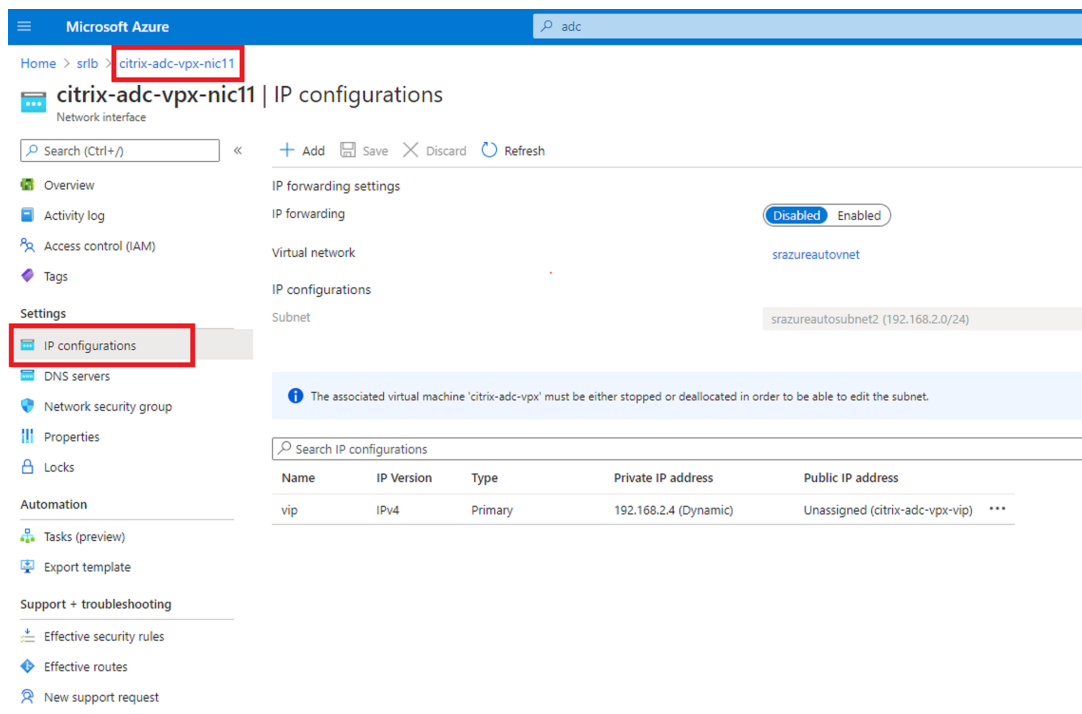

c) Start the **citrix-adc-vpx** virtual machine

Option 2: Create an Azure load balancer

Azure Load Balancer is a TCP passthrough service. The following diagram shows load balancing through TCP passthrough.

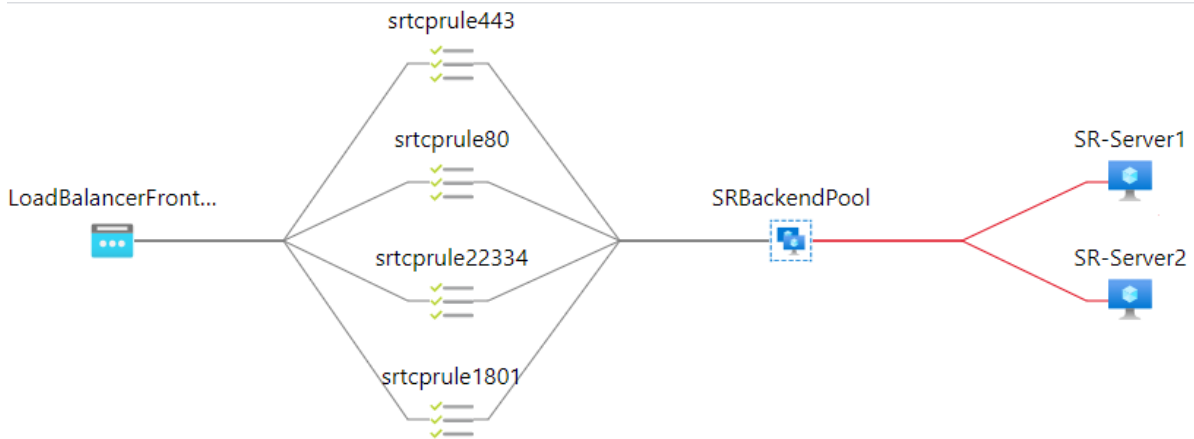

1. Create an Azure load balancer.

a) Search in the Azure portal and select **Load Balancers** from the **Marketplace**.

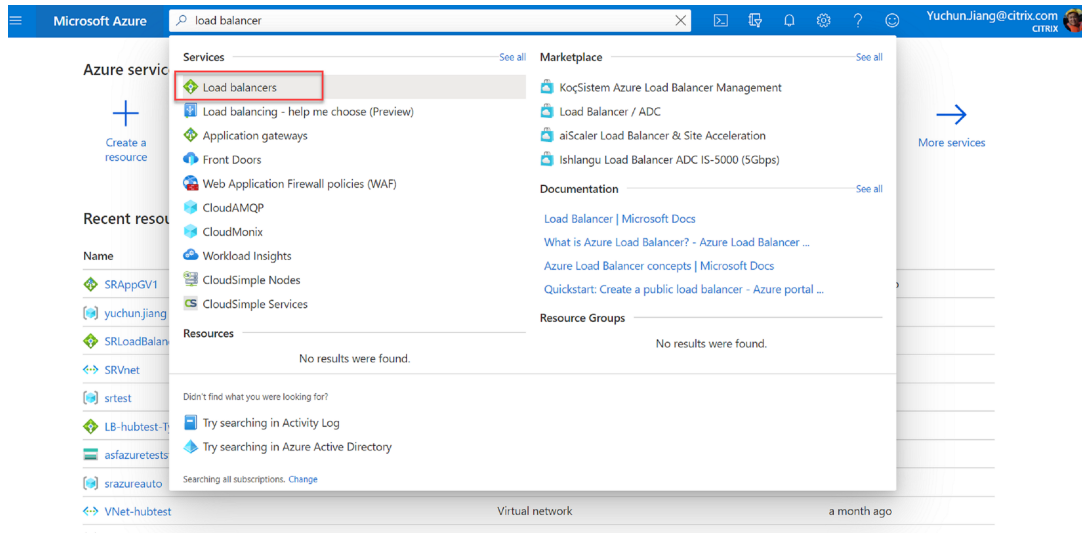

On the **Basics** tab of the **Create load balancer** page, configure settings as described in the following table:

Setting	Value
Subscription	Select your subscription.
Resource group	For example, select srlbtest created earlier.
Name	Enter SRLoadBalance .
Region	Select (US) East US .
Type	Select Internal .
SKU	Select Standard

Setting	Value
Virtual network	For example, select srazureautovnet created earlier.
Subnet	For example, select srazureautosubnet created earlier.
IP address assignment	Select Dynamic .
Availability zone	Select Zone-redundant .

Microsoft Azure

Home >

Create load balancer

is accessible via public IP addresses, or internal where it is only accessible from a virtual network. Azure load balancers also support Network Address Translation (NAT) to route traffic between public and private IP addresses. [Learn more](#).

Project details

Subscription *

Resource group * [Create new](#)

Instance details

Name * ✓

Region *

Type * Internal Public

SKU * Basic Standard

Configure virtual network.

Virtual network *

Subnet * [Manage subnet configuration](#)

IP address assignment * Static Dynamic

Availability zone *

[Review + create](#) < Previous Next : Tags > [Download a template for automation](#)

- b) Add load balancer resources, including a back-end pool, health probes, and load balancing rules.
- Add a back-end pool.

Select the load balancer you created from the resources list and click **Backend pools** in the left navigation. Click **Add** to add a back-end pool.

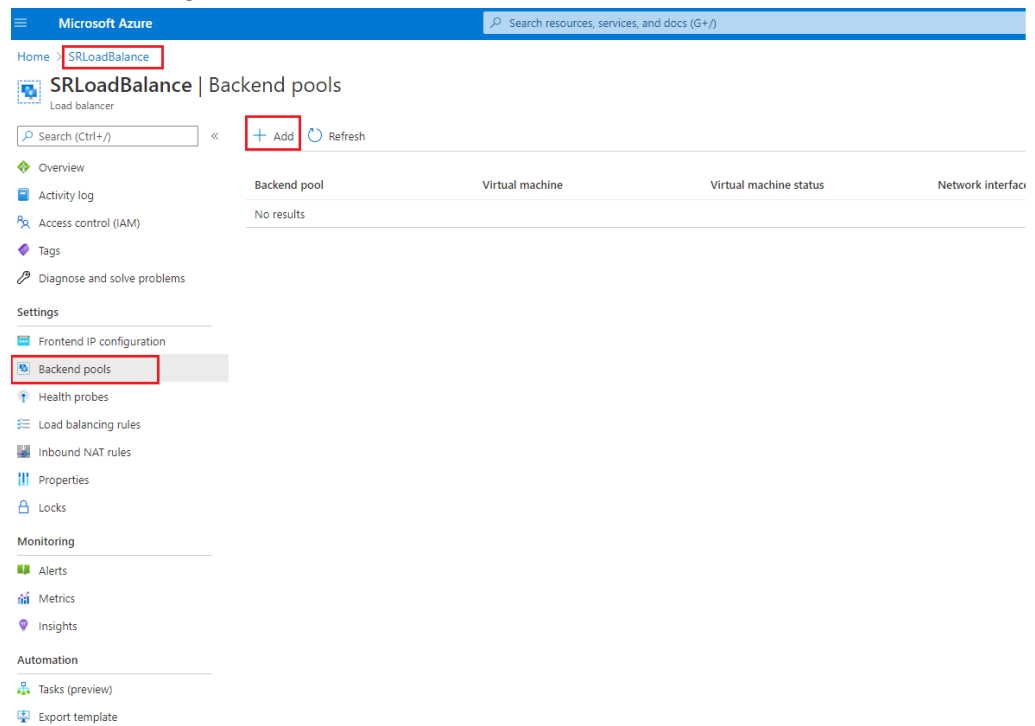

Enter a name for the new back-end pool and then click **Add**.

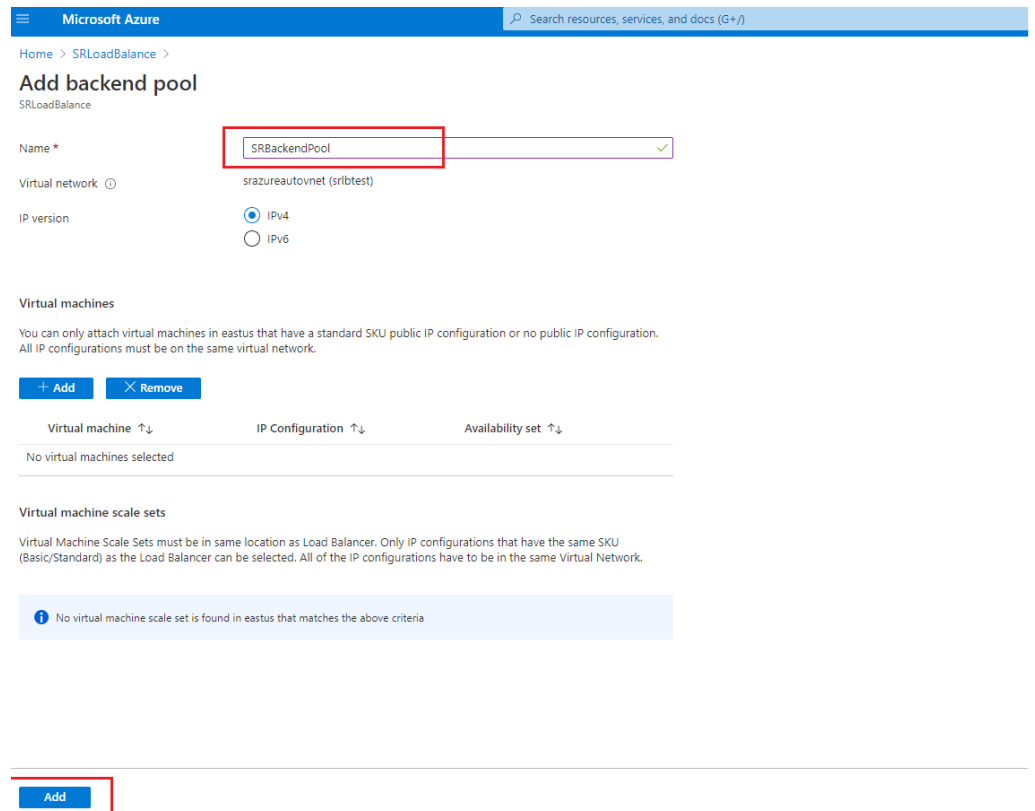

- Add health probes.

Select the load balancer you created from the resources list and then click **Health probes** in the left navigation.

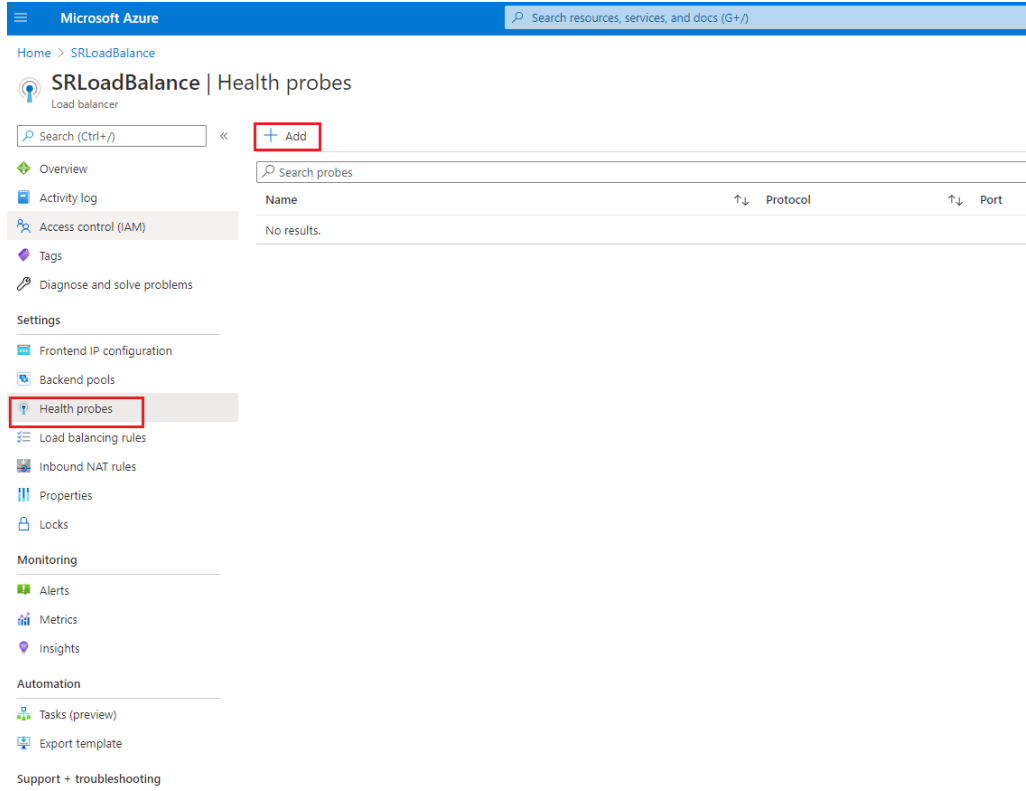

Click **Add** to add health probes on ports 80, 22334, 1801, and 443.

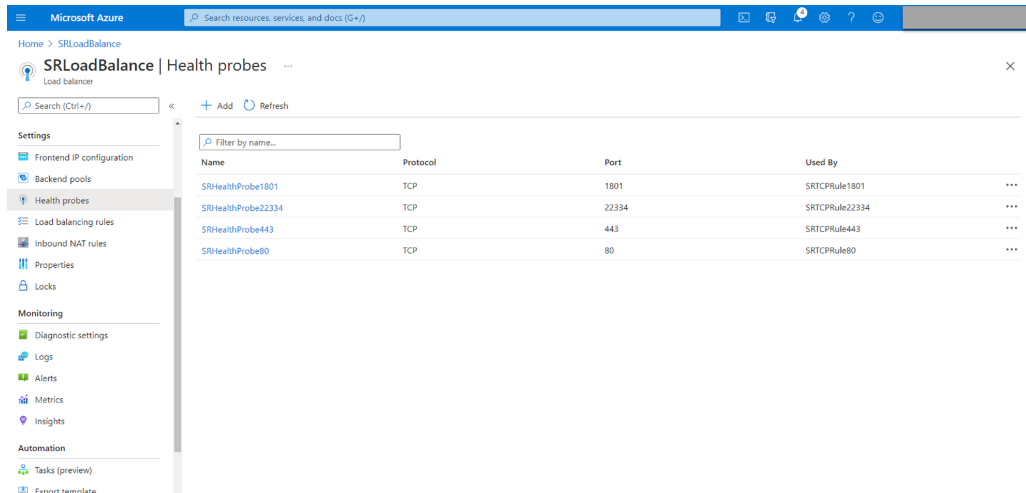

For example, use the following settings to create a health probe on port 80.

Setting	Value
Name	Enter SRHealthProbe80 .

Setting	Value
Protocol	Select TCP .
Port	Enter 80 .
Interval	5
Unhealthy threshold	Select 2 for the number of unhealthy threshold or consecutive probe failures that must occur before a VM is considered unhealthy.

The screenshot shows the Azure portal interface for configuring an SRHealthProbe. The top navigation bar includes the Microsoft Azure logo and a search bar. Below the navigation, the breadcrumb path is 'Home > SRLoadBalance > SRHealthProbe'. The main heading is 'SRHealthProbe' with a sub-heading 'SRLoadBalance'. There are three action buttons: 'Save', 'Discard', and 'Delete'. The configuration form includes the following fields:

- Name ***: A text input field containing 'SRHealthProbe80', highlighted with a red box.
- Protocol ⓘ**: A dropdown menu set to 'TCP', highlighted with a red box.
- Port * ⓘ**: A text input field containing '80', highlighted with a red box.
- Interval * ⓘ**: A text input field containing '5', with the unit 'seconds' indicated below.
- Unhealthy threshold * ⓘ**: A text input field containing '2', with the unit 'consecutive failures' indicated below.
- Used by ⓘ**: A dropdown menu set to 'Not used'.

- Add a load balancing rule.

Select the load balancer you created from the resources list and then click **Load balancing rules** in the left navigation. Click **Add** to add a load balancing rule.

Microsoft Azure | Search resources, services, and docs (G+)

Home > SRLoadBalance

SRLoadBalance | Load balancing rules

Load balancer

Search (Ctrl+/) << **+ Add**

Overview | Search load balancing rules

Name	Load balancing rule
No results.	

Settings

- Frontend IP configuration
- Backend pools
- Health probes
- Load balancing rules**
- Inbound NAT rules
- Properties
- Locks

Monitoring

- Alerts
- Metrics
- Insights

Automation

- Tasks (preview)
- Export template

Support + troubleshooting

Click **Add** to add load balancing rules for ports 80, 22334, 1801, and 443.

Microsoft Azure | Search resources, services, and docs (G+)

Home > SRLoadBalance

SRLoadBalance | Load balancing rules

Load balancer

Search (Ctrl+/) << + Add

Search load balancing rules

Name	Load balancing rule	Backend pool	Health probe
SRTCPRule1801	SRTCPRule1801 (TCP/1801)	SRBackendPool	SRHealthProbe1801
SRTCPRule22334	SRTCPRule22334 (TCP/22334)	SRBackendPool	SRHealthProbe22334
SRTCPRule443	SRTCPRule443 (TCP/443)	SRBackendPool	SRHealthProbe443
SRTCPRule80	SRTCPRule80 (TCP/80)	SRBackendPool	SRHealthProbe80

Settings

- Frontend IP configuration
- Backend pools
- Health probes
- Load balancing rules**
- Inbound NAT rules
- Properties
- Locks

Monitoring

- Diagnostic settings
- Logs
- Alerts
- Metrics
- Insights

Automation

- Tasks (preview)
- Export template

For example, use the following settings to create a load balancing rule for port 80.

Setting	Value
Name	Enter a name, for example, SRTCPRule80 .
IP Version	Select IPv4 .
Frontend IP address	Select LoadBalancerFrontEnd .
Protocol	Select TCP .
Port	Enter 80 .
Backend port	Enter 80 .
Backend pool	Select SRBackendPool .
Health probe	Select SRHealthProbe80 .
Session persistence	Select Client IP .
Idle timeout (minutes)	Accept the default setting.
TCP reset	Select Enabled .
Outbound source network address translation (SNAT)	Select (Recommended) Use outbound rules to provide backend pool members access to the internet .

Microsoft Azure

Search resources, services, and docs (G+)

Home > SRLoadBalance >

Add load balancing rule

SRLoadBalance

Name *
SRTCPRule80 ✓

IP Version *
 IPv4 IPv6

Frontend IP address * ⓘ
192.168.1.23 (LoadBalancerFrontEnd) ✓

HA Ports ⓘ

Protocol
 TCP UDP

Port *
80 ✓

Backend port * ⓘ
80 ✓

Backend pool ⓘ
SRBackendPool ✓

Health probe ⓘ
SRHealthProbe80 (TCP:80) ✓

Session persistence ⓘ
Client IP ✓

Idle timeout (minutes) ⓘ
4

TCP reset
 Disabled Enabled

Floating IP ⓘ

OK

- Add the Azure VMs where the Session Recording server is installed to the back-end pool.

The screenshot displays the Azure portal interface for configuring a load balancer. The main view shows the 'SRBackendPool' under the 'Backend pools' section. A modal window titled 'Add virtual machines to backend pool' is open, providing details on adding VMs to the pool. The modal includes a table of available VMs and their configurations.

Virtual machine	Resource group	IP Configuration	Availability set	Tags	Notes
<input type="checkbox"/> sr-server1		ipconfig1 (10.7.1.5)	-	-	-
<input type="checkbox"/> sr-server2		ipconfig1 (10.7.1.6)	-	-	-

c) Test the Azure load balancer.

If you cannot add a server to the back-end pool and the following error message appears **NetworkInterfaceAndLoadBalancerAreInDifferentAvailabilitySets**, disassociate the public IP address of the server network interface.

Microsoft Azure

Home > srlbtest > SR-Server1-ip > sr-server172 >

ipconfig1

sr-server172

Save Discard

Public IP address settings

Public IP address

Disassociate Associate

Public IP address *

SR-Server1-ip (20.62.236.36)

Create new

Private IP address settings

Virtual network/subnet

srazureautovnet/srazureautosubnet

Assignment

Dynamic Static

IP address

192.168.1.19

Option 3: Create an Azure application gateway

Tip:

Application Gateway V2 does not support routing requests through an NTLM-enabled proxy.

1. Create an Azure application gateway.

Configure the following settings when you create an application gateway.

- On the **Basics** tab, set **Tier** to **Standard**.
- On the **Frontends** tab, set **Frontend IP address type** to **Private**. The new application gateway is used as an internal load balancer.

2. Add a back-end pool.

[Home](#) > [SRAppGV1](#) >

Edit backend pool

A backend pool is a collection of resources to which your application gateway can send traffic. A backend pool can contain virtual machines, virtual machines scale sets, IP addresses, domain names, or an App Service.

Name

AGbackendpool



Add backend pool without targets

Yes

 No

Backend targets

2 items

Target type	Target	
IP address or FQDN	192.168.1.13	 ...
IP address or FQDN	192.168.1.18	 ...
IP address or FQDN <input type="text"/>	<input type="text"/>	

Associated rule

[SRHttpRule80](#)[SRHttpRule443](#)

3. Create HTTP settings.

Azure Application Gateway supports both HTTP and HTTPS for routing requests to back-end servers. Create HTTP settings for ports 80, 443, and 22334.

- HTTP over port 80

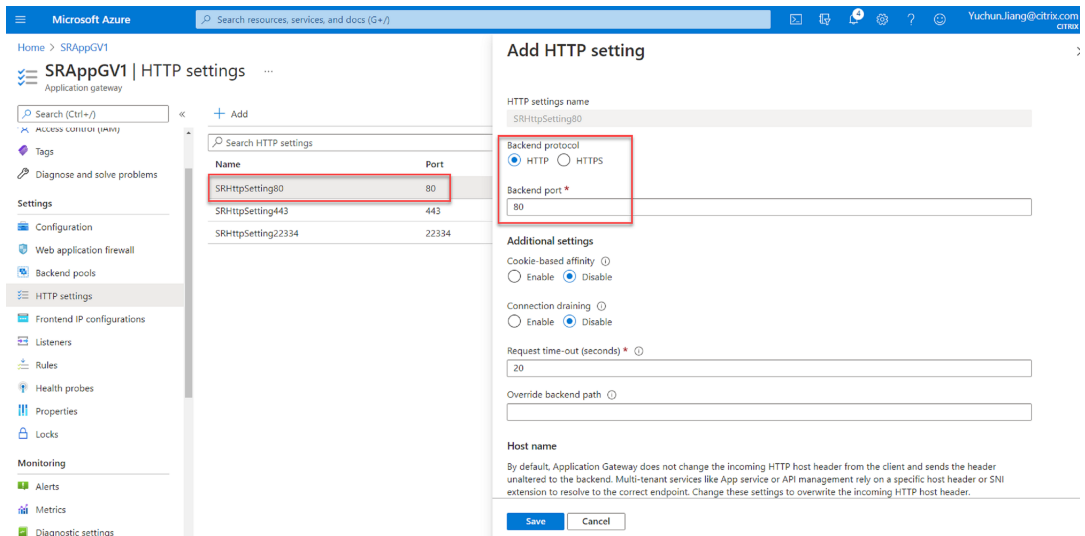

- HTTP over port 443

An authentication certificate is required to allow back-end servers in Application Gateway V1. The authentication certificate is the public key of back-end server certificates in Base-64 encoded X.509(.CER) format. For information on how to export the public key from your TLS/SSL certificate, see [Export authentication certificate \(for v1 SKU\)](#).

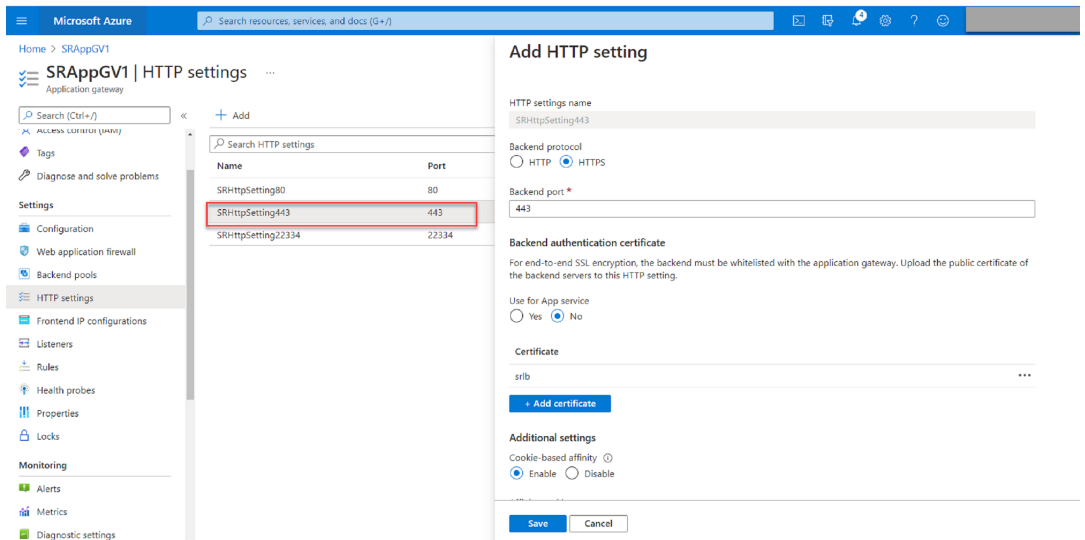

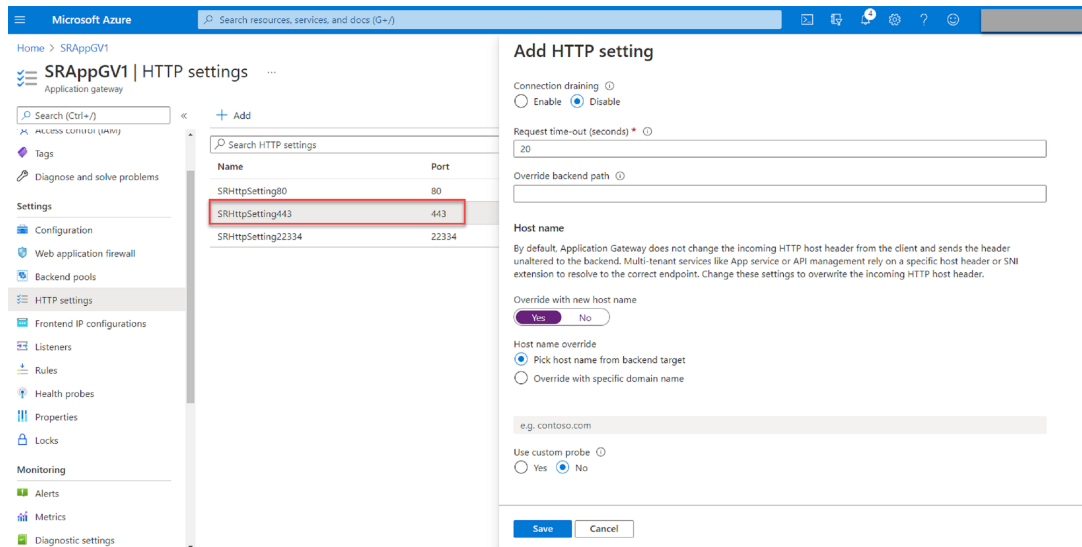

- HTTP or HTTPS over port 22334

If WebSocket uses HTTP, use the same setting as port 80.

If WebSocket uses HTTPS, use the same setting as port 443.

4. Add a front-end IP address.

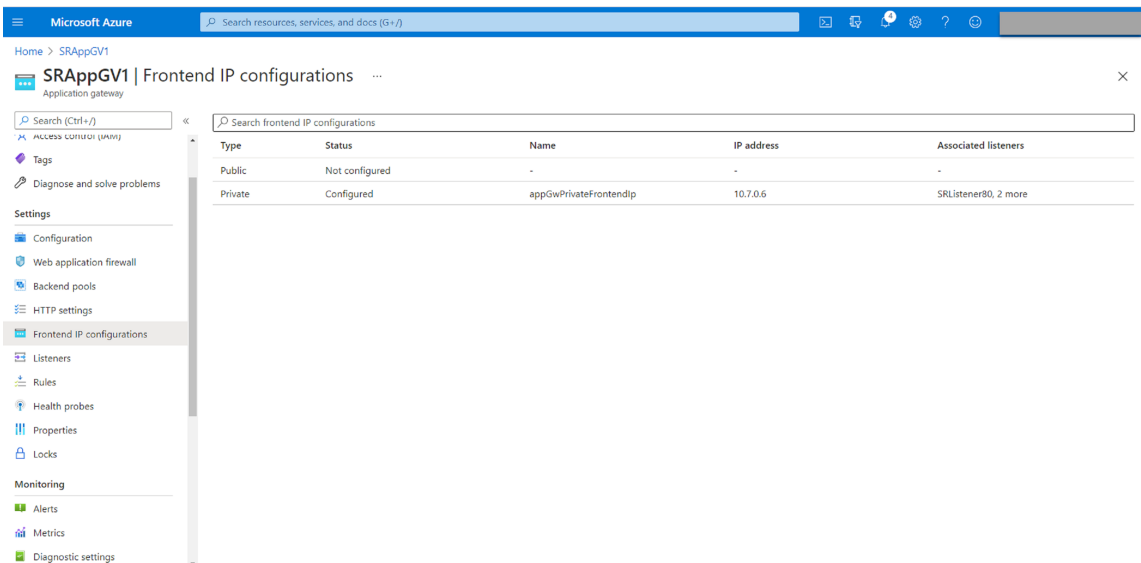

5. Add listeners.

Add listeners on ports 80, 443, and 22334, for example:

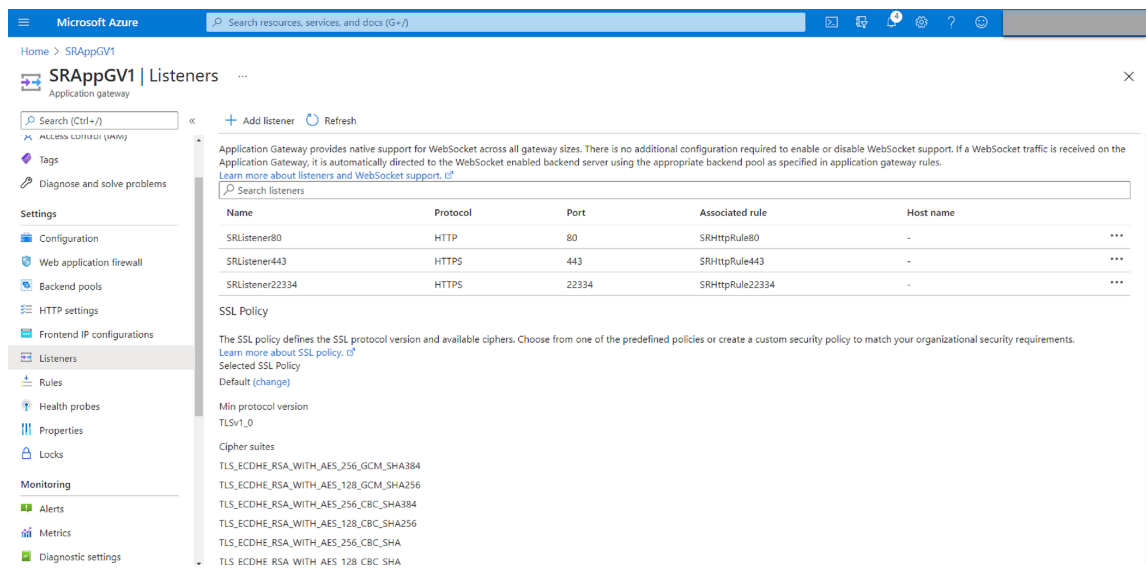

- Listener on port 80

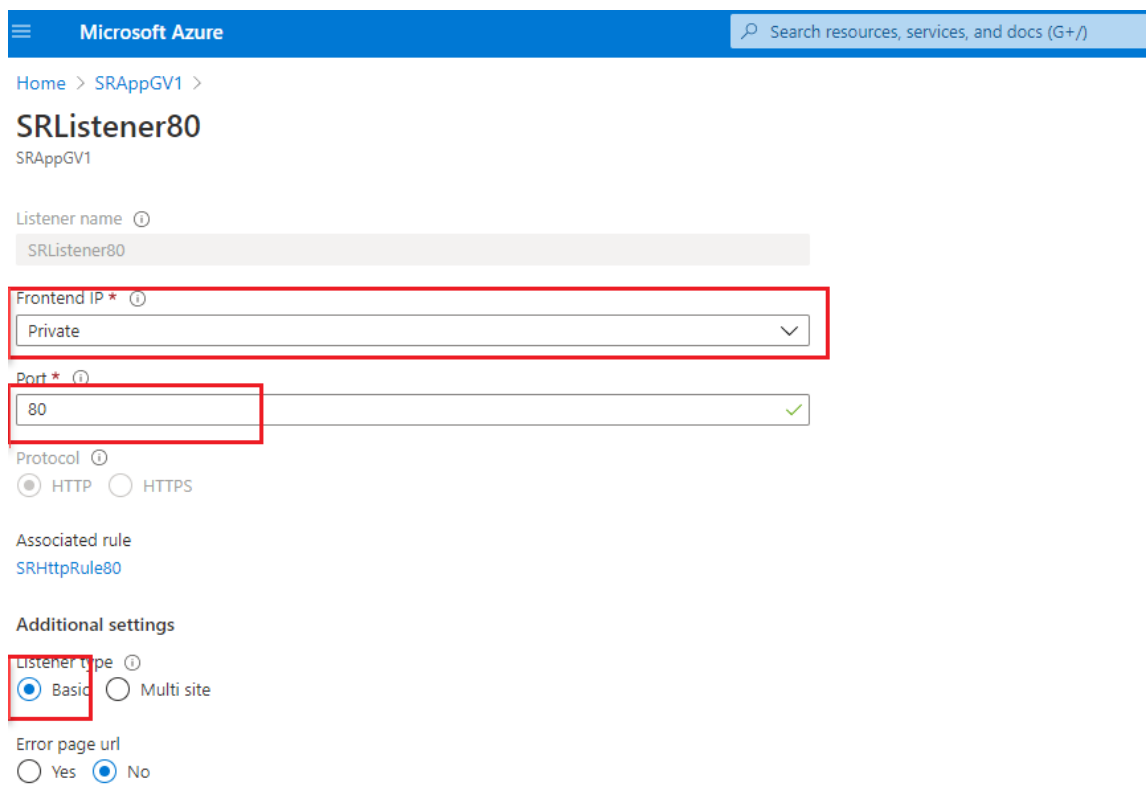

- Listener on port 443

Create a self-signed certificate and upload the certificate to the [Azure portal](#) when you create the HTTPS listener. For more information, see [Certificates supported for TLS termination](#) and [Create a self-signed certificate](#).

[Home](#) > [SRAppGV1](#) >

SRListener443

SRAppGV1

Listener name ⓘ

SRListener443

Frontend IP * ⓘ

Private

Port * ⓘ

443

Protocol ⓘ

HTTP HTTPS

Choose a certificate

Create new Select existing

Certificate *

lbdc

Renew or edit selected certificate

Associated rule

[SRHttpRule443](#)

Additional settings

Listener type ⓘ

Basic Multi site

Error page url

Yes No

- Listener on port 22334

If WebSocket uses HTTP, use the same setting as port 80. If WebSocket uses HTTPS, use the same setting as port 443. The following example shows the setting of an HTTPS listener on port 22334.

Microsoft Azure Search resources

Home > SRAppGV1 >

SRListener22334

SRAppGV1

Listener name ⓘ
SRListener22334

Frontend IP * ⓘ
Private

Port * ⓘ
22334 ✓

Protocol ⓘ
 HTTP HTTPS

Choose a certificate
 Create new Select existing

Certificate *
lbdc

Renew or edit selected certificate

Associated rule
[SRHttpRule22334](#)

Additional settings

Listener type ⓘ
 Basic Multi site

Error page url
 Yes No

6. Create request routing rules.

Create rules for ports 80, 443, and 22334, for example:

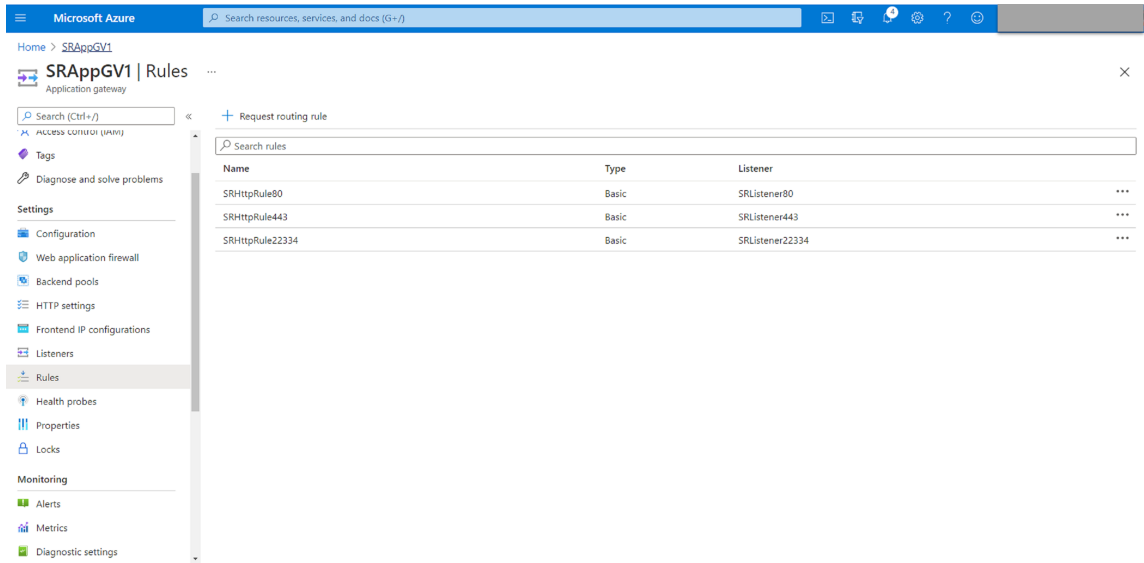

- Routing rule for port 80

SRHttpRule80

SRAppGV1

Configure a routing rule to send traffic from a given frontend IP address to one or more backend targets. A routing rule must contain a listener and at least one backend target.

Rule name

*** Listener** * Backend targets

A listener "listens" on a specified port and IP address for traffic that uses a specified protocol. If the listener criteria are met, the application gateway will apply this routing rule.

Listener *

SRHttpRule80

SRAppGV1

Configure a routing rule to send traffic from a given frontend IP address to one or more backend targets. A routing rule must contain a listener and at least one backend target.

Rule name

* Listener *** Backend targets**

Choose a backend pool to which this routing rule will send traffic. You will also need to specify a set of HTTP settings that define the behavior of the routing rule.

Target type Backend pool Redirection

Backend target *

HTTP settings *

- Routing rule for port 443

SRHttpRule443

SRApplGV1

Configure a routing rule to send traffic from a given frontend IP address to one or more backend targets. A routing rule must contain a listener and at least one backend target.

Rule name

*** Listener** *** Backend targets**

A listener "listens" on a specified port and IP address for traffic that uses a specified protocol. If the listener criteria are met, the application gateway will apply this routing rule.

Listener *

SRHttpRule443

SRApplGV1

Configure a routing rule to send traffic from a given frontend IP address to one or more backend targets. A routing rule must contain a listener and at least one backend target.

Rule name

*** Listener** *** Backend targets**

Choose a backend pool to which this routing rule will send traffic. You will also need to specify a set of HTTP settings that define the behavior of the routing rule.

Target type Backend pool Redirection

Backend target *

HTTP settings *

- Routing rule for port 22334

SRHttpRule22334

SRApplGV1

Configure a routing rule to send traffic from a given frontend IP address to one or more backend targets. A routing rule must contain a listener and at least one backend target.

Rule name

*** Listener** *** Backend targets**

A listener "listens" on a specified port and IP address for traffic that uses a specified protocol. If the listener criteria are met, the application gateway will apply this routing rule.

Listener *

SRHttpRule22334

SRApplGV1

Configure a routing rule to send traffic from a given frontend IP address to one or more backend targets. A routing rule must contain a listener and at least one backend target.

Rule name

* Listener * Backend targets

Choose a backend pool to which this routing rule will send traffic. You will also need to specify a set of HTTP settings that define the behavior of the routing rule.

Target type Backend pool Redirection

Backend target * ⓘ

HTTP settings * ⓘ

7. Add the Azure VMs where the Session Recording server is installed to the back-end pool.
8. Configure Session Recording servers according to Knowledge Center article [CTX230015](#).

Troubleshoot

December 3, 2024

The troubleshooting information contains solutions to some issues that you might encounter during or after installing the Session Recording components.

Warning:

Editing the registry incorrectly can cause serious problems that might require you to reinstall your operating system. Citrix cannot guarantee that problems resulting from the incorrect use of the Registry Editor can be solved. Use the Registry Editor at your own risk. Be sure to back up the registry before you edit it.

Diagnostic logging

December 3, 2024

Report message queue quota exceedance on each VDA to the Session Recording server

In any of the scenarios outlined below, there's a chance of exceeding the maximum size of the Microsoft Message Queuing (MSMQ) directory on a VDA, resulting in packet drops or pushback.

- On the VDA side, the incoming rate of Message Queuing messages exceeds the outgoing rate.
- The network connection between the VDA and the Session Recording server is poor and thus messages are stuck in the queue on the VDA side.
- The queue quota on the Session Recording server side is used up and messages are stuck in the queue on the VDA side.

To facilitate diagnoses and troubleshooting, Session Recording can capture and report the issues as logs to the Session Recording server for display in the Windows Event Viewer. This feature is enabled by default. You can disable and re-enable the feature by using the following registry value on the target VDA:

HKEY_LOCAL_MACHINE\SOFTWARE\Citrix\SmartAuditor\Agent\DiagnosticLoggingEnabled

Value data: 1 = enabled, 0 = disabled

You can also set how long these logs can be retained on the Session Recording database. To do so, go to the **Logging** tab of Session Recording Server Properties and configure the **Retention period for diagnostic logs**. The default value is 30 days.

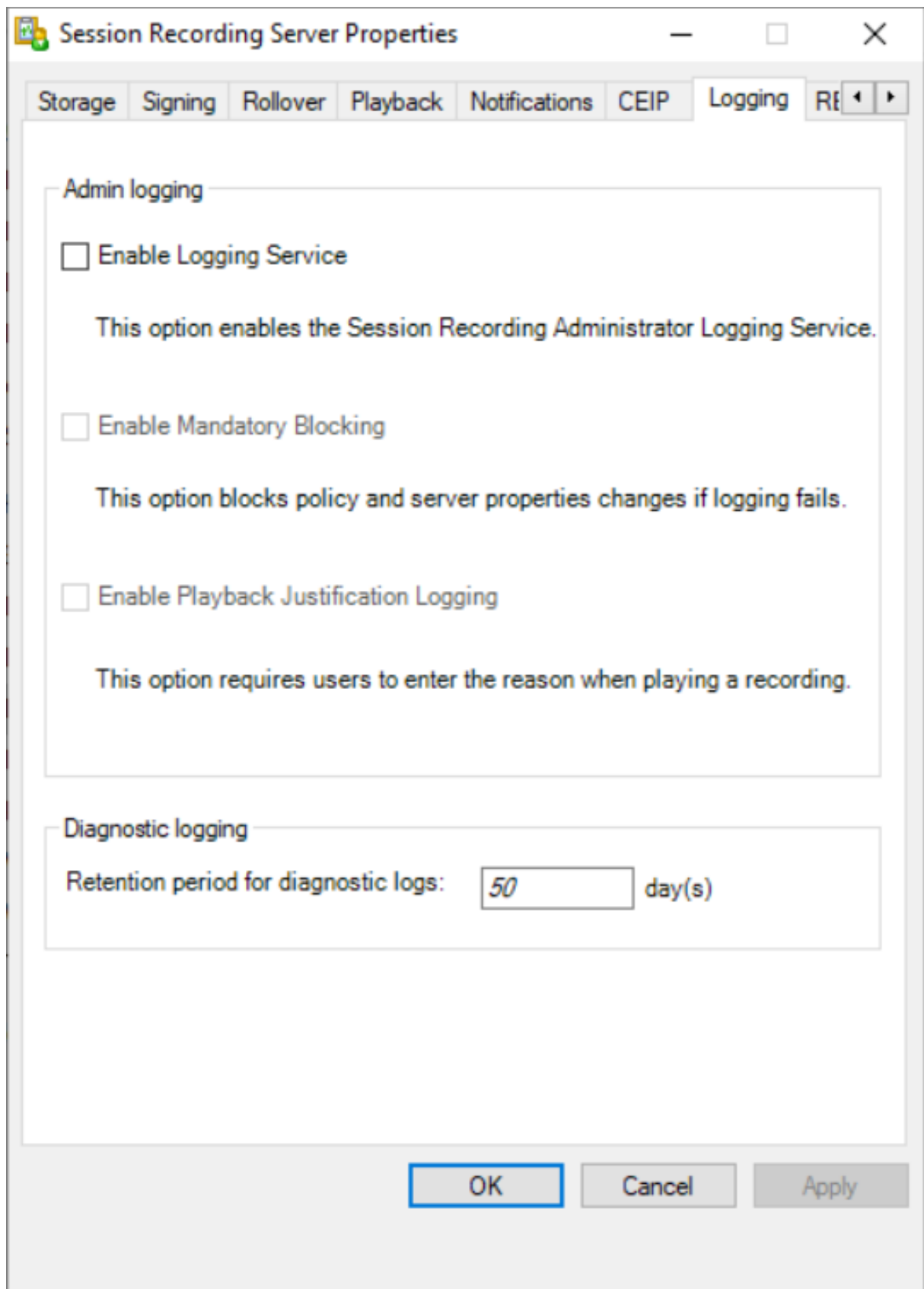

Event ID table

December 3, 2024

The following table provides a quick reference for specific event IDs and their meanings. Each event ID includes a description and a severity level to help understand the nature of the event and the appropriate response. If any of these events occur, you can check them in the Windows Event Viewer. Event logs related to the Session Recording administration components can be viewed on the Session Recording server. Event logs generated by the Session Recording agent can be viewed on the VDA. Event logs generated by the Session Recording player can be viewed on the machine where the player is installed.

Event ID	Description	Level
2001	Database Connection Established	Information
2002	Service Start Success	Information
2003	Service Stop Success	Information
2004	Error: Service Start Failure	Error
2005	Error: Data Lost For File	Error
2006	Warning: Certificate Approaching Expiry (Days)	Warning
2007	Warning: Certificate Approaching Expiry (Hours)	Warning
2008	Warning: Certificate Approaching Expiry (Minutes)	Warning
2009	Error: No Active Policy Document	Error
2010	Error: Unknown Active Policy Document	Error
2011	Error: Unsupported Active Policy Document Version	Error
2012	Error: Method Loading Active Policy Document	Error
2013	Error: Failed Verify Generated Signature	Error
2014	Error: Failed Verify CAS Configuration	Error

Event ID	Description	Level
2015	Audit: Successful File Download	Audit
2016	Audit: Successful File Query	Audit
2017	Audit: Successful New Policy Document	Audit
2018	Audit: Successful Load Policy Document	Audit
2019	Audit: Successful Save Policy Document	Audit
2020	Audit: Successful Copy Policy Document	Audit
2021	Audit: Successful Rename Policy Document	Audit
2022	Audit: Successful Set Policy Document Description	Audit
2023	Audit: Successful Set Policy Document Read Only	Audit
2024	Audit: Successful Delete Policy Document	Audit
2025	Audit: Successful Set Active Policy Document	Audit
2026	Message Rejected User On Role Based Security	Information
2027	Error: Method Principal Access Check	Error
2028	Error: Method Setting Database Connection String	Error
2029	Error: Method Get Time Adjustment	Error
2030	Error: Method Searching Files	Error
2031	Error: Method Retrieving Live File Updates	Error
2032	Error: Method Opening For Encryption	Error
2033	Error: Method Opening For Reading	Error

Event ID	Description	Level
2034	Error: Method Retrieving Encryption Percent Complete	Error
2035	Error: Method Reading File	Error
2036	Error: Method Querying File	Error
2037	Error: Method Closing File	Error
2038	Error: Method Enumerating Account Authorities	Error
2039	Error: Method Enumerating User Names	Error
2040	Error: Method Enumerating Group Names	Error
2041	Error: Method Enumerating Client Names	Error
2042	Error: Method Enumerating Client Addresses	Error
2043	Error: Method Enumerating Farm Names	Error
2044	Error: Method Enumerating Zone Names	Error
2045	Error: Method Enumerating Server Names For Farm	Error
2046	Error: Method Enumerating Server Names For Farm And Zone	Error
2047	Error: Method Enumerating Server Names For Farm And Delivery Group	Error
2048	Error: Method Enumerating Application Names	Error
2049	Error: Method Enumerating EventType Names	Error
2050	Error: Method Loading Policy Console Config File	Error
2051	Error: Method Saving Policy Console Config File	Error
2052	Error: Method Enumerating Policy Documents	Error

Event ID	Description	Level
2053	Error: Method Getting Policy Document	Error
2054	Error: Method Creating New Policy Document	Error
2055	Error: Method Loading Policy Document	Error
2056	Error: Method Saving Policy Document	Error
2057	Error: Method Copying Policy Document	Error
2058	Error: Method Renaming Policy Document	Error
2059	Error: Method Setting Policy Document Description	Error
2060	Error: Method Deleting Policy Document	Error
2061	Error: Method Getting Active Policy Document	Error
2062	Error: Method Setting Active Policy Document	Error
2063	Error: Method Running Policy Document Test Query	Error
2064	Error: Method Processing Log Service Notification	Error
2065	Error: Method Encrypting	Error
2066	Error: Method Create Directory	Error
2067	Error: Method Receiving Message	Error
2068	Error: Method Create Recorded Session File Writer	Error
2069	Error: Method Reopen Recorded Session File Writer	Error
2070	Error: Method Creating File	Error
2071	Error: Method Open File For Append	Error
2072	Error: Method Removing LRU	Error

Event ID	Description	Level
2073	Error: Method Getting File Details	Error
2074	Error: Method Removing Expired Readers	Error
2075	Error: Method Deleting File	Error
2076	Error: Method Writing File	Error
2077	Error: Method Writing Signature	Error
2078	Error: Method Opening Queue	Error
2079	Error: Method Receiving From Queue	Error
2080	Error: Method Establishing Database Connection	Error
2081	Error: Method Removing Message From Queue	Error
2082	Error: Method Load Active Cached Policy Document	Error
2083	Error: Method Init Policy Engine	Error
2084	Error: Method Enum Player User Policy Groups	Error
2085	Error: Method New Player User Policy Group	Error
2086	Error: Method Update Player User Policy Group	Error
2087	Error: Method Delete Player User Policy Group	Error
2088	Error: Method Enum Player User Role Policies	Error
2089	Error: Method New Player User Account Role Policy	Error
2090	Error: Method Delete Player User Account Role Policy	Error
2091	Error: Method Set File Hidden Attribute	Error

Event ID	Description	Level
2092	MSMQ storage quota on VDA was exceeded	Error

Installation of server components fails

December 3, 2024

The installation of the Session Recording server components fails with error codes 2503 and 2502. Resolution: Check the access control list (ACL) of folder C:\windows\Temp to ensure that the Local Users and Groups have write permission for this folder. If not, manually add write permission.

Test connection to the database fails during install

December 3, 2024

When you install the Session Recording database or the Session Recording server, the test connection fails with the error message **Database connection test failed. Please correct database instance name** even if the database instance name is correct.

In this case, ensure that the current user has the public SQL Server role permission to correct the permission limitation failure.

Agent cannot connect to the server

December 3, 2024

When the Session Recording agent cannot connect to the Session Recording server, the **Exception caught while sending poll messages to Session Recording Broker** event message is logged with an exception text. The exception text provides reasons why the connection failed. The reasons include:

- **The underlying connection was closed. Could not establish a trust relationship for the SSL/TLS secure channel.** This exception means that the Session Recording server is using a certificate signed by a CA that the server hosting the Session Recording agent does not trust or

the server hosting the Session Recording agent does not have a CA certificate. Alternatively, the certificate might have expired or been revoked.

Solution: Install a correct CA certificate on the server hosting the Session Recording agent. Use a CA that is trusted.

- **The remote server returned an error: (403) forbidden.** This standard HTTPS error occurs when you attempt to connect using HTTP that is unsecure. The machine hosting the Session Recording server rejects the connection because it accepts only secure connections.

Solution: Use **Session Recording Agent Properties** to change the Session Recording Broker protocol to **HTTPS**.

- **The Session Recording Broker returned an unknown error while evaluating a record policy query. Error code 5 (Access Denied). For more information, see the Event log on the Session Recording server.** This error occurs when sessions are started and a request for a record policy evaluation is made. The error is a result of the Authenticated Users group (the default member) being removed from the Policy Query role of the Session Recording Authorization Console.

Solution: Add the Authenticated Users group back to this role, or add each server hosting each Session Recording agent to the PolicyQuery role.

- **The underlying connection was closed. A connection that was expected to be kept alive was closed by the server.** This error means that the Session Recording server is down or unavailable to accept requests. The IIS might be offline or restarted, or the entire server might be offline.

Solution: Verify that the Session Recording server is started and connected to the network. Make sure that IIS is running on the server.

- **The remote server returned an error: 401 (Unauthorized).** This error manifests itself in the following ways:

- On startup of the Session Recording agent service, an error describing the 401 error is recorded in the event log.
- Policy query fails on the Session Recording agent.
- Session recordings are not captured on the Session Recording agent.

Solution: Ensure that the **NT AUTHORITY\Authenticated Users** group is a member of the local **Users** group on the Session Recording agent.

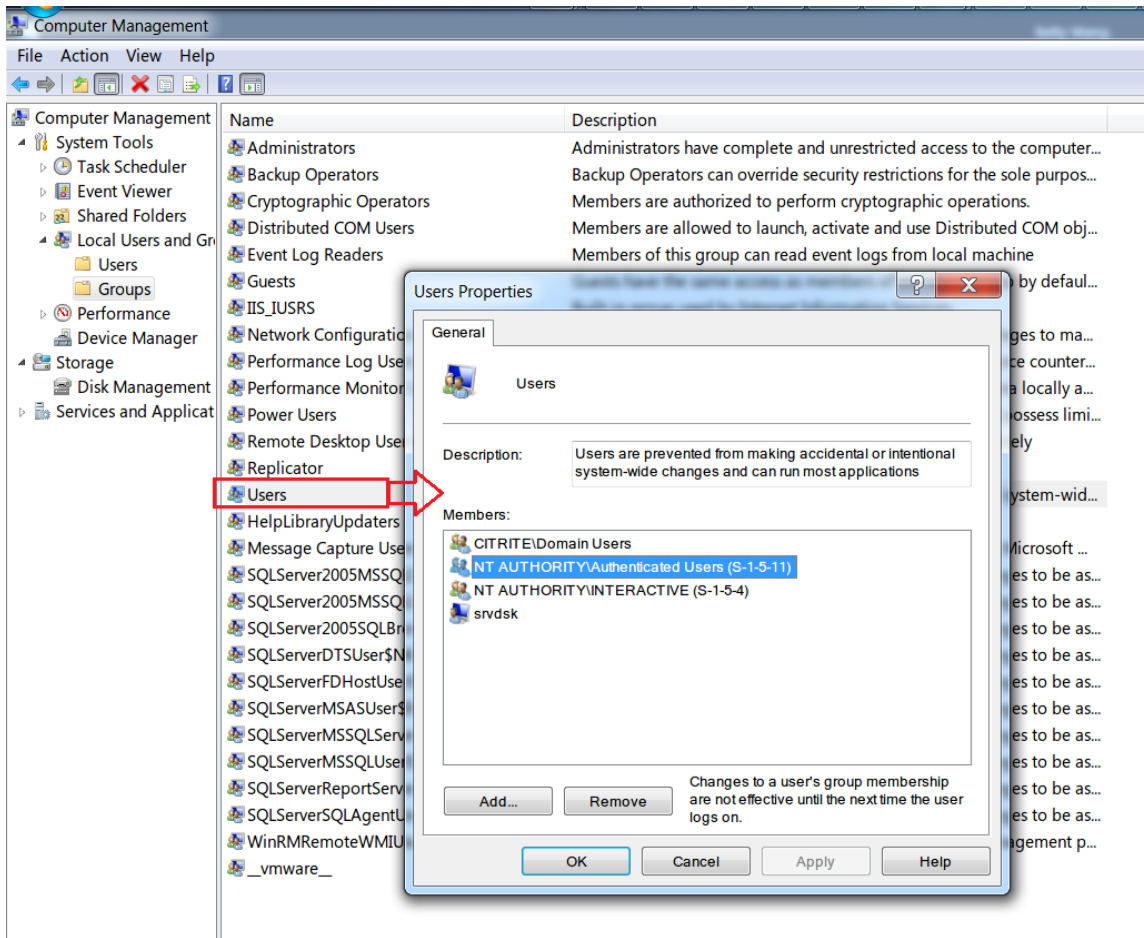

Server cannot connect to the database

December 3, 2024

When the Session Recording server can't connect to the Session Recording database, you might see a message similar to one of the following:

Event Source:

A network-related or instance-specific error occurred while establishing a connection to SQL Server. This error appears in the applications event log with ID 2047. You can find the event log in the Event Viewer on the Session Recording server.

Citrix Session Recording Storage Manager Description: Exception caught while establishing database connection. This error appears in the applications event log in the Event Viewer of the Session Recording server.

Unable to connect to the Session Recording server. Ensure that the Session Recording server is running. This error message appears when you launch the Session Recording policy console.

Resolution:

- You installed Microsoft SQL Server on a stand-alone server and failed to configure the correct services or settings for Session Recording. The server must have the TCP/IP protocol enabled and the SQL Server Browser service running. See the Microsoft documentation for information about enabling these settings.
- During the Session Recording installation (administration portion), incorrect server/database information was given. Uninstall the Session Recording database and reinstall it, supplying the correct information.
- The Session Recording database server is down. Verify that the server has connectivity.
- The machine hosting the Session Recording server or the machine hosting the Session Recording database server cannot resolve the FQDN or NetBIOS name of the other. Use the ping command to verify that the names can be resolved.
- Check the firewall configuration on the Session Recording Database to ensure that the SQL Server connections are allowed. For more information, see the Microsoft article at <https://docs.microsoft.com/en-us/sql/sql-server/install/configure-the-windows-firewall-to-allow-sql-server-access?redirectedfrom=MSDN&view=sql-server-ver15>.

Logon failed for user 'NT_AUTHORITY\ANONYMOUS LOGON'. This error message means that the services are logged on incorrectly as .\administrator.

Resolution: Restart the services as local system user and restart the SQL services.

Check the recording success rate

December 3, 2024

You can check the recording success rate to learn whether all sessions that match the active recording policy are recorded. The recording success rate is calculated as follows:

Recording success rate = the number of successfully recorded sessions / the total number of sessions matching the active recording policy

Prerequisites

- This feature requires the Session Recording server minimum version 2203.
- To obtain site configuration and session data for accurate calculation, you must install the Broker PowerShell Snap-in (Broker_PowerShellSnapIn_x64.msi). You can locate the snap-in on the

Citrix Virtual Apps and Desktops ISO (\x64\Citrix Desktop Delivery Controller) and follow the instructions to install it.

- For an on-premises Delivery Controller, install and use the Citrix Virtual Apps and Desktops PowerShell SDK. For a Delivery Controller in Citrix Cloud, install and use the Citrix DaaS Remote PowerShell SDK. To determine which SDK to install and use, be aware of the Delivery Controller that you specified when you configured your recording policy.

Steps

To check the recording success rate across your deployment, complete the following steps:

1. Use a domain user account with proper permission to log on to the machine where you have installed the Session Recording server.
2. Start PowerShell and change the current drive to the **<Session Recording server installation path>\Bin** folder.
3. Run a command based on the type of your deployment:
 - For an on-premises Delivery Controller, run either of the following commands as needed:
 - If the FQDN of the Session Recording server is the same with the FQDN in the certificate bound to the Session Recording server, run **SsRecUtils.exe -CalcRecSuccessRate <Delivery Controller address>**.
 - If you have specified a custom domain name with the certificate binding, run **SsRecUtils.exe -CalcRecSuccessRate <Delivery Controller address> -SRBrokerURL <custom domain name>**.
 - For a Delivery Controller in Citrix Cloud, run the following commands in sequence:
 - **Add-PSSnapin Citrix.Broker.Admin.V2**
 - **Set-XDCredentials -CustomerId “<Citrix Cloud customer ID>”-SecureClientFile “<path to secure client file>”-ProfileType CloudApi -StoreAs default**
 - **get-xdauthentication**
 - **SsRecUtils.exe -CalcRecSuccessRate CloudDDC**
4. Check the recording success rate. If all sessions that match the currently active recording policy are recorded, the recording success rate is 100%. Otherwise, the recording success rate is lower than 100% and you are prompted to check failed recordings in a file where session details are provided. For example:

100% recording success rate

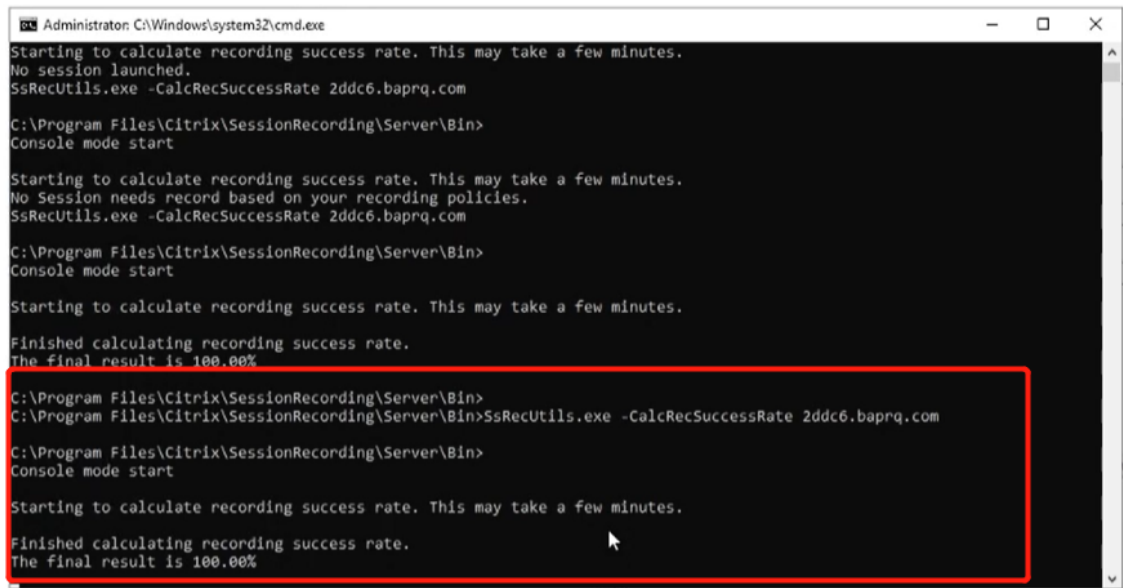

```
Administrator: C:\Windows\system32\cmd.exe
Starting to calculate recording success rate. This may take a few minutes.
No session launched.
SsRecUtils.exe -CalcRecSuccessRate 2ddc6.baprq.com
C:\Program Files\Citrix\SessionRecording\Server\Bin>
Console mode start
Starting to calculate recording success rate. This may take a few minutes.
No Session needs record based on your recording policies.
SsRecUtils.exe -CalcRecSuccessRate 2ddc6.baprq.com
C:\Program Files\Citrix\SessionRecording\Server\Bin>
Console mode start
Starting to calculate recording success rate. This may take a few minutes.
Finished calculating recording success rate.
The final result is 100.00%
C:\Program Files\Citrix\SessionRecording\Server\Bin>
C:\Program Files\Citrix\SessionRecording\Server\Bin>SsRecUtils.exe -CalcRecSuccessRate 2ddc6.baprq.com
C:\Program Files\Citrix\SessionRecording\Server\Bin>
Console mode start
Starting to calculate recording success rate. This may take a few minutes.
Finished calculating recording success rate.
The final result is 100.00%
```

50% recording success rate

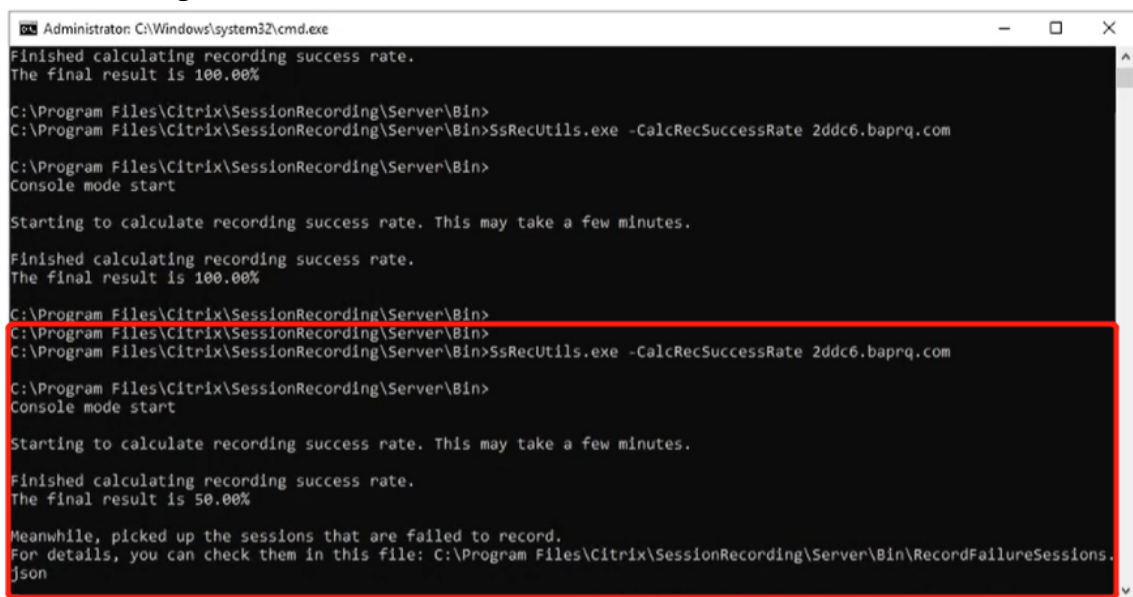

```
Administrator: C:\Windows\system32\cmd.exe
Finished calculating recording success rate.
The final result is 100.00%
C:\Program Files\Citrix\SessionRecording\Server\Bin>
C:\Program Files\Citrix\SessionRecording\Server\Bin>SsRecUtils.exe -CalcRecSuccessRate 2ddc6.baprq.com
C:\Program Files\Citrix\SessionRecording\Server\Bin>
Console mode start
Starting to calculate recording success rate. This may take a few minutes.
Finished calculating recording success rate.
The final result is 100.00%
C:\Program Files\Citrix\SessionRecording\Server\Bin>
C:\Program Files\Citrix\SessionRecording\Server\Bin>
C:\Program Files\Citrix\SessionRecording\Server\Bin>SsRecUtils.exe -CalcRecSuccessRate 2ddc6.baprq.com
C:\Program Files\Citrix\SessionRecording\Server\Bin>
Console mode start
Starting to calculate recording success rate. This may take a few minutes.
Finished calculating recording success rate.
The final result is 50.00%
Meanwhile, picked up the sessions that are failed to record.
For details, you can check them in this file: C:\Program Files\Citrix\SessionRecording\Server\Bin\RecordFailureSessions.json
```

Sessions are not recording

December 3, 2024

If application sessions **are not recording** successfully, check the application event log in the Event Viewer on the Session Recording agent and Session Recording server. Doing so can provide valuable diagnostic information.

If sessions **are not recording**, the possible cause might be:

- **Component connectivity and certificates.** If the Session Recording components cannot communicate with each other, session recording can fail. To troubleshoot recording issues, verify that all components are configured correctly to point to the correct machines and that all certificates are valid and correctly installed.
- **Non-domain-joined machines.** Session Recording is designed to run in a domain environment. If you are not running in an Active Directory or Azure Active Directory environment, you might experience recording issues. Ensure that all Session Recording components are running on machines that are members of an Active Directory domain or Azure Active Directory domain.
- **Session sharing conflicts with the active policy.** Session Recording matches the active policy with the first published application that a user opens. Subsequent applications opened during the same session continue to follow the policy that is in force for the first application. To prevent session sharing from conflicting with the active policy, publish the conflicting applications on separate multi-session OS VDAs.
- **Recording is not enabled.** By default, installing the Session Recording Agent on a multi-session OS VDA enables recording for the VDA. Recording does not occur until an active recording policy is configured to allow it.
- **The active recording policy does not permit recording.** A session can be recorded only when the session meets the rules of the active recording policy.
- **Session Recording services are not running.** For sessions to be recorded, the Session Recording Agent service must be running on a multi-session OS VDA and the Session Recording Storage Manager service must be running on the machine hosting the Session Recording Server.
- **MSMQ is not configured.** If MSMQ is not correctly configured on the server running the Session Recording Agent and the machine hosting the Session Recording Server, recording problems might occur.

Unable to view live session playback

December 3, 2024

If you experience difficulties when viewing recordings using the Session Recording player, the following error message might appear:

Download of recorded session file failed. Live session playback is not permitted. The server has been configured to disallow this feature. This error indicates that the server is configured to disallow the action.

Resolution: In **Session Recording Server Properties**, choose the **Playback** tab and select the **Allow live session playback** check box.

Recordings are corrupted or incomplete

December 3, 2024

- When you view corrupted or incomplete recordings in the player, you might also see warnings in the Event logs on the Session Recording server.

Event Source: Citrix Session Recording Storage Manager

Description: Data lost while recording file **<icl file name>**

The issue occurs when MCS or PVS is used to create VDAs with a master image configured and Microsoft Message Queuing (MSMQ) installed. In this condition, the VDAs have the same **QMID** for MSMQ.

As a workaround, create a unique **QMID** for each VDA. For more information, see [Install, upgrade, and uninstall](#).

- The Session Recording player might report an internal error with the message - “**The file being played has reported that an internal system error (error code: 9) occurred during its original recording. The file can still be played up to the point that the recording error occurred**” when playing back a certain recording file.

The issue occurs due to insufficient buffer size on the Session Recording Agent when graphic intensive sessions are recorded.

As a workaround, change `HKEY_LOCAL_MACHINE\SOFTWARE\Citrix\SmartAuditor\SmAudBufferSizeMB` to higher value data on the Session Recording agent, and then restart the machine.

Verify component connections

December 3, 2024

During the setup of Session Recording, the components might not connect to other components. All the components communicate with the Session Recording server (Broker). By default, the Broker (an IIS component) is secured using the IIS default website certificate. If one component can't connect to the Session Recording server, the other components might also fail when attempting to connect.

The Session Recording agent and the Session Recording server (Storage Manager and Broker) log connection errors in the applications event log. You can view the log in the Event Viewer of the machine hosting the Session Recording server. The Session Recording policy console and the Session Recording player display connection error messages on screen when they fail to connect.

Verify that the Session Recording agent is connected

1. Log on to the server where the Session Recording agent is installed.
2. From the **Start** menu, choose **Session Recording Agent Properties**.
3. In **Session Recording Agent Properties**, click **Connection**.
4. Verify that the correct FQDN is entered in the **Session Recording Server** field.
5. Verify that the server given as the value for the Session Recording server is accessible to your VDA for multi-session OS.

For more information, see [Agent cannot connect to the server](#).

Note:

Check the application event log for errors and warnings.

Verify that the Session Recording server is connected

Caution:

Using the Registry Editor can cause serious problems that might require you to reinstall the operating system. Citrix cannot guarantee that problems resulting from incorrect use of the Registry Editor can be solved. Use the Registry Editor at your own risk.

1. Log on to the machine hosting the Session Recording server.
2. Open the Registry Editor.
3. Browse to `HKEY_LOCAL_MACHINE\SOFTWARE\Citrix\SmartAuditor\Server`.
4. Verify that the **SmAudDatabaseInstance** value correctly references the Session Recording database you installed on your SQL Server instance.

For more information, see [Server cannot connect to the database](#).

Verify that the Session Recording database is connected

1. Using a SQL Management tool, open your SQL instance that contains the Session Recording database you installed.
2. Open the Security permissions of the Session Recording database.
3. Verify that the Session Recording Computer Account has access to the database. For example, if the machine hosting the Session Recording server is named **SsRecSrv** in the MIS domain, the computer account in your database must be configured as **MIS\SsRecSrv\$**. This value is configured during the Session Recording database installation.

Test IIS connectivity

You can test connections to the Session Recording server IIS site by using a Web browser to access the Session Recording Broker webpage. It can help you determine whether problems with communication between Session Recording components stem from misconfigured protocol configuration, certification issues, or problems starting Session Recording Broker.

To verify IIS connectivity for the Session Recording agent:

1. Log on to the server where the Session Recording Agent is installed.
2. Open a Web browser and type the following address:
 - For HTTPS: <https://servername/SessionRecordingBroker/RecordPolicy.rem?wsdl>, where `servername` is the name of the machine hosting the Session Recording server.
 - For HTTP: <http://servername/SessionRecordingBroker/RecordPolicy.rem?wsdl>, where `servername` is the name of the machine hosting the Session Recording server.
3. If you are prompted for NT LAN Manager (NTLM) authentication, log on with a domain administrator account.

To verify IIS connectivity for the Session Recording player:

1. Log on to the workstation where the Session Recording player is installed.
2. Open a Web browser and type the following address:
 - For HTTPS: <https://servername/SessionRecordingBroker/Player.rem?wsdl>, where `servername` is the name of the machine hosting the Session Recording server.
 - For HTTP: <http://servername/SessionRecordingBroker/Player.rem?wsdl>, where `servername` is the name of the machine hosting the Session Recording server.
3. If you are prompted for NT LAN Manager (NTLM) authentication, log on with a domain administrator account.

To verify IIS connectivity for the Session Recording policy console:

1. Log on to the server where the Session Recording policy console is installed.
2. Open a Web browser and type the following address:
 - For HTTPS: <https://servername/SessionRecordingBroker/PolicyAdministration.rem?wsdl>, where `servername` is the name of the machine hosting the Session Recording server.

- For HTTP: `http://servername/SessionRecordingBroker/PolicyAdministration.rem?wsdl`, where `servername` is the name of the machine hosting the Session Recording server.
3. If you are prompted for NT LAN Manager (NTLM) authentication, log on with a domain administrator account.

If you see an XML document within your browser, it verifies that the Session Recording policy console is connected to the Session Recording server using the configured protocol.

Troubleshoot certificate issues

If you are using HTTPS as your communication protocol, the machine hosting the Session Recording server must be configured with a server certificate. All component connections to the Session Recording server must have root certificate authority (CA). Otherwise, attempted connections between the components fail.

You can test your certificates by accessing the Session Recording Broker webpage as you would when testing IIS connectivity. If you are able to access the XML page for each component, the certificates are configured correctly.

Here are some common ways certificate issues cause connections to fail:

- **Invalid or missing certificates.** If the server running the Session Recording agent does not have a root certificate to trust the server certificate and cannot trust and connect to the Session Recording server over HTTPS, causing connectivity to fail, verify that all components trust the server certificate on the Session Recording server.
- **Inconsistent naming.** If the server certificate assigned to the machine hosting the Session Recording server is created using an FQDN, all connecting components must use the FQDN when connecting to the Session Recording server. If a NetBIOS name is used, configure the components with a NetBIOS name for the Session Recording server.
- **Expired certificates.** If a server certificate expired, connectivity to the Session Recording server through HTTPS fails. Verify the server certificate assigned to the machine hosting the Session Recording server is valid and has not expired. If the same certificate is used for the digital signing of session recordings, the event log of the Session Recording server provides error messages that the certificate expired or warning messages when it is about to expire.

Search for recordings using the player fails

December 3, 2024

If you experience difficulties when searching for recordings using the Session Recording player, the following error messages might appear:

- **Search for recorded session files failed. The remote server name could not be resolved: servename.** The **servename** is the name of the server to which the Session Recording player is attempting to connect. The Session Recording player cannot contact the Session Recording server. Two possible reasons are an incorrectly typed server name or that the DNS cannot resolve the server name.

Resolution: From the player menu bar, choose **Tools > Options > Connections** and verify that the server name in the **Session Recording Servers** list is correct. If it is correct, from a command prompt, run the ping command to see if the name can be resolved. When the Session Recording server is down or offline, the search for recorded session files failed error message is **Unable to contact the remote server**.

- **Unable to contact the remote server.** This error occurs when the Session Recording server is down or offline.

Resolution: Verify that the Session Recording server is connected.

- **Access denied.** An access denied error can occur if the user was not given permission to search for and download recorded session files.

Resolution: Assign the user to the Player role using the Session Recording Authorization Console.

- **Access denied when the Player role is assigned.** This error occurs when you install the Session Recording player on the same machine with the Session Recording server, and you have enabled UAC. When you assign the Domain Admins or Administrators user group as the Player role, a non-built-in administrator user in that group might fail to pass the role-based check.

Resolutions:

- Run the Session Recording player as an administrator.
 - Assign specific users as the Player role rather than the entire group.
 - Install the Session Recording player in a separate machine rather than the Session Recording server.
- **Search for recorded session files failed. The underlying connection was closed. Could not establish a trust relationship for the SSL/TLS secure channel.** The error occurs when the Session Recording server uses a certificate that is signed by a CA that the client device does not trust or have a CA certificate for.

Resolution: Install the correct or trusted CA certificate workstation where the Session Recording player is installed.

- **The remote server returned an error: (403) forbidden.** This error is a standard HTTPS error that occurs when you attempt to connect using HTTP (nonsecure protocol). The server rejects the connection because, by default, it is configured to accept only secure connections.

Resolution: From the **Session Recording Player** menu bar, choose **Tools > Options > Connections**. Select the server from the **Session Recording Servers** list, and click **Modify**. Change the protocol from **HTTP** to **HTTPS**.

Troubleshoot MSMQ

If a notification message is given but the viewer cannot find any recordings after a search in the Session Recording player, there is a problem with MSMQ. Verify that the queue is connected to the Session Recording server (Storage Manager). Use a Web browser to test for connection errors (if you are using HTTP or HTTPS as your MSMQ communication protocol).

To verify that the queue is connected:

1. Log on to the server hosting the Session Recording Agent and view the outgoing queues.
2. Verify that the queue to the machine hosting the Session Recording server has a connected state.
 - If the state is **waiting to connect**, there are messages in the queue, and the protocol is HTTP or HTTPS (corresponding to the protocol selected on the **Connections** tab in **Session Recording Agent Properties**), perform Step 3.
 - If the state is **connected** and there are no messages in the queue, there might be a problem with the server hosting the Session Recording server. Skip Step 3 and perform Step 4.
3. If there are messages in the queue, open a Web browser and type the following address:
 - For HTTPS: [https://servername/msmq/private\\$/CitrixSmAudData](https://servername/msmq/private$/CitrixSmAudData), where `servername` is the name of the machine hosting the Session Recording server.
 - For HTTP: [http://servername/msmq/private\\$/CitrixSmAudData](http://servername/msmq/private$/CitrixSmAudData), where `servername` is the name of the machine hosting the Session Recording server.

If the page returns an error such as **The server only accepts secure connections**, change the MSMQ protocol listed in **Session Recording Agent Properties** to HTTPS. If the page reports a problem with the website security certificate, there might be a problem with a trust relationship for the TLS secure channel. In that case, install the correct CA certificate or use a CA that is trusted.

4. If there are no messages in the queue, log on to the machine hosting the Session Recording server and view private queues. Select **citrixsmauddata**. If there are messages in the queue

(Number of Messages Column), verify that the Session Recording StorageManager service is started. If it is not, restart the service.

Record Linux sessions (preview)

December 3, 2024

As an experimental feature starting with the Linux VDA 2212, you can record and replay sessions hosted on a Linux VDA. For more information, see [Session recording \(preview\)](#) in the Linux VDA documentation.

Note:

All the policies you set for recording Windows sessions don't apply to the Linux session recording.



© 2024 Cloud Software Group, Inc. All rights reserved. This document is subject to U.S. and international copyright laws and treaties. No part of this document may be reproduced in any form without the written authorization of Cloud Software Group, Inc. This and other products of Cloud Software Group may be covered by registered patents. For details, please refer to the Virtual Patent Marking document located at <https://www.cloud.com/legal>. Citrix, the Citrix logo, NetScaler, and the NetScaler logo and other marks appearing herein are either registered trademarks or trademarks of Cloud Software Group, Inc. and/or its subsidiaries in the United States and/or other countries. Other marks are the property of their respective owner(s) and are mentioned for identification purposes only. Please refer to Cloud SG's Trademark Guidelines and Third Party Trademark Notices (<https://www.cloud.com/legal>) for more information.