



Profile Management 2311

Contents

Profile Management 2311	7
What's new	7
Fixed issues	9
Known issues	10
Third party notices	11
System requirements	12
Quick start guide	15
How Profile Management works	17
About profiles	18
Assign profiles	20
Profile Management architecture	21
Profile Management use cases	25
Access multiple resources	28
Logon diagram	29
Logoff diagram	32
Plan your deployment	34
Decide on a configuration	34
Pilot or production	36
Migrate or create profiles	37
Persistent or provisioned and dedicated or shared	38
Mobile or static	40
Which applications are in use	41
Plan for multiple platforms	45

Share Citrix user profiles on multiple file servers	47
Administer profiles within and across OUs	48
Domain and forest support in Profile Management	50
High availability and disaster recovery with Profile Management	50
Scenario 1 - Basic setup of geographically adjacent user stores and failover clusters	51
Scenario 2 - Multiple folder targets and replication	56
Scenario 3 - Disaster recovery	58
Scenario 4 - The traveling user	60
Scenario 5 - Load-balancing user stores	60
Plan folder redirection with Profile Management	62
Third-party directory, authentication, and file services	64
FAQs about profiles on multiple platforms and Profile Management migration	65
Install and set up	69
Download the installation package	69
Install Profile Management	70
Test Profile Management with a local GPO	74
Create the user store	75
Upgrade and migrate	77
Upgrade Profile Management	80
Migrate user profiles	82
Configure	85
Configuration precedence	85
Enable Profile Management	87
Specify the path to the user store	88

Include and exclude items	91
Default inclusions and exclusions	93
Include and exclude items	96
Use wildcards	99
Enable logon exclusion check	100
Stream user profiles	101
Replicate user stores	105
Set up profile containers	108
Enable multi-session write-back for profile containers	117
Control access to applications	120
Enable and configure user-level policy settings	127
Enable support for Azure AD joined and non-domain-joined VDA machines	156
Enable credential-based access to user stores	157
Enable large file handling	160
Enable file deduplication	161
Enable native Outlook search experience	165
Enable the OneDrive container	169
Enable UWP app roaming (preview)	171
Configure VHD settings	173
Resolve conflicting profiles	179
Specify a template or mandatory profile	180
Choose a migration policy	181
Define which groups' profiles are processed	182
Migrate user store	183

Automatic migration of existing application profiles	185
Store certificates	187
Configure folder redirection	188
Manage transactional folders	189
Configure offline profiles	194
Configure the Customer Experience Improvement Program (CEIP)	195
Configure active write-back	196
Configure cross-platform settings	197
Operating systems and applications supported by cross-platform settings	200
Create a definition file	202
Application definition file structure	205
Cross-platform settings - Case study	211
Initial configuration	211
Plan the new site	213
Execute the plan	214
Other considerations	219
Enable application profiler	219
Force user logoffs	220
Synchronize file security attributes	220
Enable asynchronous processing for user Group Policy on logon	221
Profile Management policies	222
Profile Management policies	235
Profile Management policy descriptions and defaults	247
Policies for file-based and container-based solutions	280

Integrate	289
Profile Management and Citrix Virtual Apps	289
Profile Management and Citrix Virtual Desktops	290
Profile Management and UE-V	295
Profile Management and Citrix Content Collaboration	295
Profile Management and App-V	296
Profile Management and Provisioning Services	297
Preconfigure Profile Management on provisioned images	299
Profile Management and Self-service Plug-in	300
Profile Management and VMware	300
Profile Management and Outlook	301
Using Windows profiles with Password Manager and single sign-on	302
Firefox browser	306
Google Chrome browser	306
Secure	307
Troubleshoot	310
Check Profile Management settings	310
Check Profile Management log files	311
Check Windows events	316
Troubleshoot common issues	332
Perform advanced troubleshooting	338
Contact Citrix Technical Support	341
Best practices	344
Improve user logon performance	350

Save storage space using file deduplication	352
Glossary	354

Profile Management 2311

July 26, 2024

Profile Management is intended as a profile solution for Citrix Virtual Apps servers, virtual desktops created with Citrix Virtual Desktops, and physical desktops. You install Profile Management on each computer whose profiles you want to manage.

Active Directory Group Policy Objects allow you to control how Citrix user profiles behave. Although many settings can be adjusted, in general you only need to configure a subset, as described in these topics.

The best way of choosing the right set of policy selections to suit your deployment is to answer the questions in the [Decide on a configuration](#) article.

Usage rights for Profile Management are described in the EULA.

For information on the terminology used in these topics, see [Glossary](#).

What's new

August 6, 2024

What's new in 2311

This release includes the following new features and enhancements. It also addresses several issues that help to improve overall performance and stability.

Improved user store selection

By default, when multiple user stores are available, Profile Management selects the store with the latest profile data. If more than one store has the latest profile, Profile Management selects the one configured earliest.

With a new policy, **User store selection method**, you can now enable Profile Management to select the store with the best access performance. For more information, see [Change the user store selection method](#).

Files deduplication support extended to profile containers

File deduplication has been extended to profile containers, allowing you to efficiently reduce storage costs for profile containers. By default, Profile Management deduplicates files from profile containers only when those files are larger than 256 MB. If necessary, you can increase this threshold size using a new policy, **Minimum size of files to deduplicate from profile containers**. For more information, see [Enable file deduplication](#).

Support for force logging off users when the profile container is unavailable during logon

By default, when the profile container is unavailable during user logon, a user logs on using the temporary profile instead. However, this behavior leads to data loss for any changes made during the session. With a new policy, **Log off users when profile container is not available during logon**, you can now force log-off users in such cases. For more information, see [Set up profile containers](#).

Support for enabling read access to profile containers

By default, a profile container is accessible only to its owner. With a new policy, **Users and groups to access profile container**, you can now enable other users to have Read access to the profile container. This policy empowers you to exercise more precise and secure control over profile container access. For more information, see [Grant AD users Read access to profile containers](#).

Support for enabling both multi-session write-back and local caching for profile containers

In container-based profile solutions, you can now enable both the **Enable multi-session write-back for profile containers** and **Enable local caching for profile containers** policies. This enhancement improves user experience by combining the benefits of both policies, which include:

- Data consistency across concurrent sessions (through multi-session write-back)
- Faster logon and logoff times and reduced network load (through local caching)

For more information, see [Set up profile containers](#).

Multi-session runtime sync support for OneDrive files

With the OneDrive container enabled, any changes a user makes to OneDrive files in a session are now instantly visible in its concurrent sessions. This improvement reduces synchronization conflicts and ensures data integrity. For more information, see [Enable the OneDrive container](#).

Single Sign-On (SSO) sync support for OneDrive Container

With this enhancement, users now don't have to reenter credentials for OneDrive during subsequent logons, improving user convenience. For more information, see [Enable the OneDrive container](#).

Support for the new Microsoft Teams

With the UWP app roaming policy enabled, the new Microsoft Teams app can now roam with users. Therefore, users can access the same Microsoft Teams app with their personalized settings and data from different devices.

Health check enhancements

We've enhanced our Profile Management health check tool to provide more comprehensive health checks. Besides the existing status checks, the tool can now provide more checks such as an assessment of logon times, letting you quickly identify and resolve issues that might impact the user experience.

Enhanced Profile Management logs

We've enhanced Profile Management logs to provide more details for user logon and logoff processes. This improvement enables you to quickly pinpoint the underlying reasons for slow logons or logoffs. For more information, see [Check Profile Management log files](#).

New Windows events for monitoring size changes and sync process durations for pending areas

We've added more Windows events for monitoring tools to track both size changes and sync process durations for the pending area. This enhancement provides you with valuable data to more efficiently identify and resolve relevant issues. For more information, see [Check Windows events](#).

Fixed issues

August 6, 2024

Profile Management 2311 contains the following fixed issues compared with Profile Management 2305 LTSR:

- The **Logon Exclusion Check** policy might not work as expected. [UPM-5621]

- You might experience a prolonged logon time while loading user sessions. [UPM-5666]
- When using the DFS namespace path as the Citrix Profile Management store path, the profile containers might fail to attach to the VDAs. As a result, the user profiles are unavailable. [UPM-5791]
- With the **Profile streaming** policy enabled, accessing or fetching profile files from the user store might fail with the following error message: *The file can't be accessed by the system*. [UPM-5883]
- After you enable the **Enable profile streaming for folders** policy and configure some relative paths to the user profile using the **Profile Streaming Exclusion list - directories** policy, the files under these relative paths might not work as expected after successful logons. [UPM-5884]
- After upgrading VDAs to version 1912 LTSR CU8, the user profiles might fail to load from the store. Instead, the users are provided with the local profiles. [UPM-5893]
- VDAs might experience a fatal exception on upmjit.sys and display a blue screen. [UPM-5896]

Known issues

August 6, 2024

- The latest Windows 11 update causes Profile Management to fail in creating the user-level search index database file. This issue is affecting the proper functioning of the Outlook container. [UPM-6233]
- With the full profile container or the OneDrive container enabled, the following message appears when a user logs on to a machine:
 - The user has been using the OneDrive folder before the container is enabled, and
 - This is the first time that the user logs on to a machine after the container is enabled.

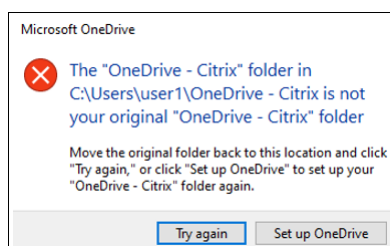

To resolve the issue, click **Try again**. The OneDrive folder is then successfully migrated to the container. [UPM-4166]

- The message “Folder Access Denied” appears when users move a folder to the Recycle Bin in the following situations:
 - With the partial profile container or the OneDrive container enabled, users try to delete a folder from either container.
 - With the full profile container enabled, users try to delete a folder that is not in the user profile folder but on the same disk as the profile.

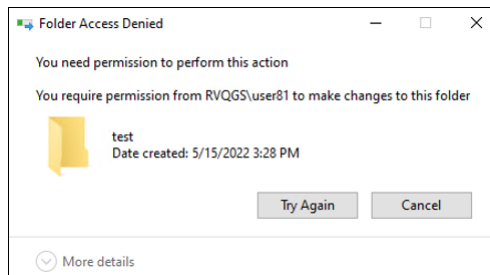

To work around this issue, perform permanent deletion instead:

- Select the folder, and press **Shift + Delete** to delete it permanently.
- Set **Recycle Bin Properties** to **Don't move files to the Recycle Bin. Remove files immediately when deleted.** [UPM-4165]

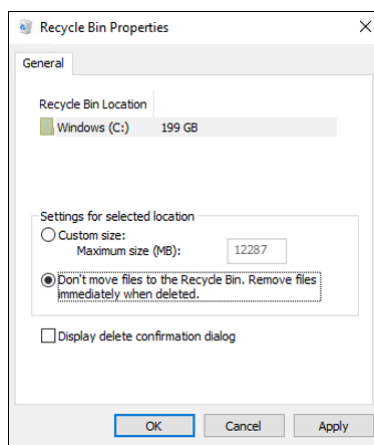

- Some sections of the Start menu might not populate. To work around this issue, run the `gpupdate /force` command from the command prompt. [UPM-1933]

Third party notices

August 6, 2024

The current release of Profile Management might include third-party software licensed under the terms defined in the following document:

[Profile Management Third Party Notices](#)

System requirements

August 6, 2024

Software requirements

Systems running Profile Management must be based on one of the following operating systems:

- **Desktops** - Microsoft Windows 11, Windows 10, Windows 8.1, and Windows 7 Service Pack 1.
In Citrix virtual desktops environments, Windows Store applications (also known as UWP apps) are supported.
- **Servers** - Standard and Datacenter Editions of Windows Server 2022, Windows Server 2019, Windows Server 2016, Windows Server 2012 R2, Windows Server 2012, and Windows Server 2008 R2 Service Pack 1.

Note:

Citrix Profile Management is supported only on operating system versions that are supported by their manufacturer. You might need to purchase extended support from your operating system manufacturer.

With Enhanced Protected Mode (EPM), cookies in Microsoft Internet Explorer 10 or later are not supported on Windows 7 or later. When EPM is enabled, Profile Management does not process or handle cookies.

Every user must have access to the user store, a network folder where profiles are stored centrally. Alternatively, profiles can be stored in users' home drives if preferred. For more information, see [Profile Management architecture](#).

Unless you use XenDesktop 7, where Profile Management is integrated into Citrix Studio, Active Directory (AD) Group Policy Objects (GPOs) are required for configuration. AD forest functional and domain functional levels of Windows Server 2008 and Windows Server 2012 native mode are supported. For more information, see [Domain and forest support in Profile Management](#). Alternatively, you can use a local .ini file for configuration settings, but in general, the .ini file is used for testing purposes only. Settings in the .ini file are applied for any setting not configured in the GPO, that is any Group Policy setting that is left in the Not Configured state.

If short file names (also known as 8.3 file names) are mandated in a Citrix product or component you are using with Profile Management, do not disable short file name support in your Profile Management deployment. Doing so might cause issues when files are copied to and from the user store.

On computers running the Profile Management Service, store profiles on a single disk mounted by drive letter. If a disk is mounted into a folder that is used to store a user's profile (a typical example is C:\Users), it might be masked from the Service and not processed.

Citrix product compatibility

Profile Management can be used with the following Citrix products:

- Citrix Virtual Desktops
- Citrix Virtual Apps
- Citrix Virtual Apps and Desktops
- Citrix DaaS (formerly Citrix Virtual Apps and Desktops service)

For the compatibility matrix of Profile Management and Citrix Virtual Apps and Desktops, see [Additional Lifecycle Information for Citrix Profile Management](#).

For more information about using this Current Release (CR) in a Long Term Service (LTSR) environment and other FAQs, see [Knowledge Center article](#).

Downloads

To download Profile Management

1. Navigate to the Citrix download page.
2. Log on to My Account. Your account must be associated with the licensing entitlement for the Citrix product that you have deployed. If your account is not associated with your license entitlement, contact Citrix Customer Service.
3. In Find Downloads, select your product and select Components as the download type.
4. Download the latest version of Profile Management.

Diagnostics feature

Before you can use Citrix Diagnostic Facility to capture trace logs, ensure it is available with the Citrix product or component that is used on the device, virtual desktop, or Citrix server whose profiles you want to monitor.

Cross-platform settings

To use the cross-platform settings feature in this release, install Microsoft Core XML Services (MSXML) 6.0 Service Pack 1 or later on all computers running the Profile Management Service. This component is part of Microsoft .NET Framework 3.5 and is required to process definition files.

Use this feature only with the supported set of operating systems and applications. For more information, see [Operating systems and applications supported By cross-platform settings](#).

Migrating existing profiles to Citrix user profiles

Migration from the following profile types to Citrix user profiles is supported:

- Windows roaming profiles
- Local profiles based on any of the following operating systems:
 - Windows 11
 - Windows 10
 - Windows 8
 - Windows 7
 - Windows Vista
 - Windows XP
 - Windows Server 2022
 - Windows Server 2019
 - Windows Server 2016
 - Windows Server 2012 R2
 - Windows Server 2012
 - Windows Server 2008 R2
 - Windows Server 2008
 - Windows Server 2003
- Citrix user profiles created with User Profile Manager 2.0

Migration from the following profile types to Citrix user profiles is unsupported:

- Microsoft mandatory profiles.

Tip: You can use the template profile feature of Profile Management to configure a Microsoft mandatory profile as a Citrix mandatory profile. Citrix mandatory profiles are used for all logons and function exactly like regular Citrix user profiles except that no user changes are saved. For information, see [Specify a template or mandatory profile](#).
- Citrix mandatory profiles.
- Citrix user profiles created with a User Profile Manager Technical Preview release or beta release.

- Third-party profiles (including sepagoPROFILES).

You cannot upgrade from a 32-bit Citrix user profile to a 64-bit one.

Quick start guide

August 6, 2024

This article provides a quick reference to installing and configuring Profile Management.

Prerequisites

Verify that all system requirements are met. For details, see [System requirements](#).

Install Profile Management

Profile Management is included with the installation of the Virtual Delivery Agent (VDA). For VDAs, to install or upgrade Profile Management, simply install or upgrade your VDA software.

Deploying Profile Management consists of installing an .msi file and either an .adm, or an .admx file. To install the files, follow the steps in [Install and set up](#).

Note:

To avoid potential conflicts, add the Citrix Profile Management process (%ProgramFiles%\Citrix\User Profile Manager\UserProfileManager.exe) to your antivirus software's exclusion list. For more information, see [Citrix Antivirus Best Practices](#).

Decide on where to centrally configure Profile Management

There are three ways you can centrally configure Profile Management. Choose one way from the following:

- Using a GPO in Active Directory
- Using policies in Citrix Studio
- Using Workspace Environment Management (WEM)

For instructions on configuring Profile Management using a GPO in Active Directory, see Knowledge Center article [CTX222893](#).

For instructions on configuring Profile Management using policies in Citrix Studio, see Knowledge Center article [CTX222893](#).

For instructions on configuring Profile Management using WEM, see Knowledge Center article [CTX229258](#).

Configure Profile Management

Configure basic settings

1. [Create the user store](#)

Recommendations on creating secure user stores –including creating a file share and setting folder permissions –are available in the Microsoft article [Deploying Roaming User Profiles](#). These minimum recommendations ensure a high level of security for basic operation.

2. [Specify the path to the user store](#)

3. [Enable Profile Management](#)

4. Verify basic settings

To verify your basic settings, complete the following steps:

- a) In Citrix Studio, set the **Enable logging**, **Logon**, and **Logoff** policies to **Enabled**.
- b) Log on to a VDA and run `gpupdate /force` as an administrator.
- c) Log off and log back on to the VDA.
- d) Go to the default log file path, `C:\Windows\System32\Logfiles\UserProfileManager`, open the `pm.log` file, look for logon events, and verify that the following messages are present:

```
1 Starting logon processing...
2 Finished logon processing successfully in [s]:
```

Plan your Profile Management configuration

1. To [plan a Profile Management deployment](#), decide on a set of policy settings that, together, form a configuration that is suitable for your environment and users. The **Automatic configuration** feature in [User profiles](#) simplifies some of this decision-making for Citrix virtual apps and desktops deployments.

To determine the recommended approach to deploying, answer the following basic questions about your environment:

- [Pilot or production](#)
 - [Migrate or create profiles](#)
 - [Persistent or provisioned and dedicated or shared](#)
 - [Mobile or static](#)
 - [Which applications are in use](#)
2. Do the following to configure Profile Management accordingly:
 - Stream user profiles, see [Stream user profiles](#).
 - Enable active write back, see [Configure active write back](#).
 - Specify a mandatory profile, see [Specify a template or mandatory profile](#).
 - Configure exclusions, see [Include and exclude items](#).
 - Configure folder redirection, see [Configure folder redirection](#).
 - Configure applications, see [Enable native Outlook search experience](#).
 3. Verify Profile Management settings.
 - a) Verify basic settings as stated earlier in this article.
 - b) Check the `pm_configure.log` file for policy settings. Verify that the following messages are present:

```
1 Configuration value read from Policy: LoggingEnabled=  
2 Configuration value read from INI file: CEIPEnabled=  
3 Configuration value PSAlwaysCache set neither in policy nor in  
INI file. Defaulting to:
```

Troubleshoot

For details, see [Troubleshoot](#).

How Profile Management works

August 6, 2024

Profile Management addresses user profile deficiencies in environments where simultaneous domain logons by the same user introduce complexities and consistency issues to the profile. For example, if a user starts sessions to two different virtual resources based on a roaming profile, the profile of the

session that terminates last overrides the profile of the first session. This problem, known as “last write wins,” discards any personalization settings that the user makes in the first session.

You can tackle the problem by using separate profiles for each resource silo. However, this approach results in increased administration overhead and storage capacity requirements. Another drawback is that users experience different settings depending on the resource silo they access.

Profile Management optimizes profiles in an easy and reliable way. At interim stages and at logoff, registry changes and the files and folders in the profile are saved to the user store for each user. If, as is common, a file exists, it is overwritten if it has an earlier time stamp.

At logon, users’ registry entries and files are copied from the user store. If a locally cached profile exists, the two sets are synchronized. As a result, all settings for all applications and silos are available during the session. And it is no longer necessary to maintain a separate user profile for each silo. Citrix streamed user profiles can further enhance logon times.

Profile Management helps to safeguard application settings for mobile users who experience network disruption (if the offline profiles features are configured) and users who access resources from different operating systems (if the cross-platform settings feature is configured).

Note: Profile Management processes domain user logons not local accounts.

Where network-based profiles are employed, consider adopting Profile Management in your organization. You might be able to implement other solutions such as mandatory or roaming profiles, and maintain them with standard knowledge of Microsoft Windows. However, unless your deployment is restricted (for example, a call center where user customization is limited so mandatory profiles are appropriate), Profile Management might be preferred.

Citrix recommends using folder redirection so that user-specific data is saved separately from the profile.

The home-folder and template paths must be configured only with the network location.

About profiles

August 6, 2024

A Windows user profile is a collection of folders, files, and registry and configuration settings that define the environment for a user who logs on with a user account. These settings can be customizable by the user, depending on the administrative configuration. Examples of settings that can be customized are:

- Desktop settings such as wallpaper and screen saver
- Shortcuts and Start menu setting

- Internet Explorer Favorites and Home Page
- Microsoft Outlook signature
- Printers

Some user settings and data can be redirected by folder redirection. However, if folder redirection is not used, these settings are stored within the user profile.

Types of profiles

Windows includes several types of profiles:

Profile Type	Storage Location	Configuration		
		Location	Application	Save Changes?
Local	Local device	Local device	Local device only	Yes
Roaming	Network	Active Directory	Any device accessed	Yes
Mandatory (Mandatory Roaming)	Network	Active Directory	Any device accessed	No
Temporary	Not Applicable	Not Applicable	Local device only	No

A temporary profile is only assigned when a specific profile type cannot be assigned. Except mandatory profiles, a distinct profile typically exists for each user. Mandatory profiles do not allow users to save any customizations.

For Remote Desktop Services users, a specific roaming or mandatory profile can be assigned to avoid issues that might occur if the same profile is assigned to a user within a Remote Desktop Services session and a local session.

Profile versions

Versions of Microsoft Windows user profiles are as follows:

- Version 6 –Windows 11, Windows 10 1607 and later, Windows Server 2016, Windows Server 2019, and Windows Server 2022
- Version 5 –Windows 10 RTM
- Version 4 –Windows 8.1 and Windows Server 2012 R2
- Version 3 - Windows 8 and Windows Server 2012
- Version 2 - Windows Vista, Windows 7, Windows Server 2008, and Windows Server R2

- Version 1 –Operating systems earlier than Windows Vista and Windows Server 2008

The folder structure (or namespace) of Microsoft’s Version 1 profiles is mostly interchangeable. For example, the folders on Windows XP and Windows Server 2003 are almost identical. Likewise, the structure of Version 2 profiles is mostly interchangeable.

However, the namespace is different between Version 1 and later profiles. This folder structure was changed in the later operating systems to provide user-specific folders isolated for user and application data. Version 1 profiles store data in the root folder, **Documents and Settings**. Version 2 profiles store data in a more intuitively named folder called **Users**. For example, the folder contents of **AppData\Local** in Windows Vista is the same as the contents of **Documents and Settings\<username>\Local Settings\Application Data** in Windows XP.

For more information about the differences between Version 1 and later profiles, see [Managing Roaming User Data Deployment Guide](#).

Assign profiles

August 6, 2024

What methods can I use in Windows to assign profiles to users?

This article refers to the assignment of profiles in Microsoft Windows not Citrix Profile Management.

You can assign profiles to users in several ways:

- Using their user account properties in Active Directory (AD)
- Using Group Policy (GP)
- Using the preceding methods to assign profiles specific to Remote Desktop Services (formerly known as Terminal Services) sessions

Some of these methods are only available in specific operating systems:

- **Remote Desktop Services.** To assign Remote Desktop Services profiles on Windows Server 2008 R2, use the GPO setting Set path for Remote Desktop Services Roaming User Profile. It is located in Computer Configuration\Administrative Templates\Windows Component\Remote Desktop Services\Remote Desktop Session Host\Profiles. On earlier multi-session operating systems, use the setting Set path for TS Roaming Profiles, which is located in Computer Configuration\Administrative Templates\Windows Components\Terminal Services.

To configure profiles for individual users, you can also set Set path for TS Roaming Profiles on the individual accounts in the User Account Properties pages in AD. However, typically it is much better to make this assignment in GP.

You can use the setting Use mandatory profiles on the terminal server to force the use of mandatory profiles.

- **Windows 7, Windows 8, and Windows Server:** Set roaming profiles on individual accounts using the User Account Properties pages. Also, for Windows Server 2008 AD and Windows 7 devices, you can use the GPO setting Set roaming profile path for all users logging on to this computer. This is located in Computer\Administrative Templates\System\User Profiles. For users logging on to Windows 8 or Windows Server 2012 computers, you can also set users' home folders using Active Directory in Windows Server 2012.

What is the priority order for delivering profiles to domain users if more than one method is used?

When Profile Management is used to manage a user's profile, it takes precedence over any other profile assignment method. A user whose profile data is not managed by Profile Management might be assigned a profile using multiple methods. The actual profile used is based on the following precedence:

1. Citrix user profile (that is, a profile created by Profile Management)
2. Remote Desktop Services profile assigned by a GPO
3. Remote Desktop Services profile assigned by a User Property
4. Roaming profile assigned by a GPO (Windows Server 2008 AD and Windows 7 only)
5. Roaming profile assigned by a User Property

Profile Management architecture

August 6, 2024

This article describes the folder structure of the user store and of the cross-platform settings store. The user store is the central location for Citrix user profiles. The cross-platform settings store is a separate location.

Important information about Profile Management stores

The structures of the user store and cross-platform settings store are described here for information purposes and to assist with localizing and troubleshooting. Follow these important recommendations, which are designed to minimize problems with profile data and maintain security:

- Do not change the structure of either store.

- Do not write files and folders directly to any part of a store. The user store is different in this respect from any redirected folders.
- Keep the user store separate from any redirected folders. You can keep them on disjoint shares of the same file server or DFS namespace, for example `\\server1\profiles\%username%` and `\\server1\folders\%username%`. This technique also makes it much easier to support Version 1 and Version 2 profiles together, and to support a single set of redirected folders shared by both profile versions.
- Users do not need to see the user store, so do not map a drive letter to it.
- Do not impose quotas on the user store. If you restrict profile size, consider excluding items rather than using a quota.

Folder structure of the user store

The user store defaults to the **WINDOWS** folder in the user's home directory. This simplifies pilot installations, but for production systems, configure the user store to be a network share or (for best scalability) a DFS namespace. Supported configurations for enterprise-ready user stores are described in [High availability and disaster recovery with Profile Management](#).

Recommendations on creating secure user stores are available in the article called [Create a file share for roaming user profiles](#) on the Microsoft TechNet website. These minimum recommendations ensure a high level of security for basic operation. Also, when configuring access to the user store, include the Administrators group, which is required to modify or remove a Citrix user profile.

Note: On Windows 7 and Windows 2008 R2 client devices, do not select the **Encrypt data access** check box while creating the share on Windows 2012 R2 File Server.

The folder structure of the user store at the root level is shown in this table.

Folder	Notes
\	The root of a profile in the user store.
\UPM_Profile	This folder contains files and folders from the profile.
\UPM_Drive_C	This folder contains any included items from outside the profile (in this case from drive C). This folder is present during upgrades from Profile Management 4.x or earlier. Managing items outside the profile is not supported in Profile Management 5.0.

Folder	Notes
\Pending	This folder contains the lock file, any pending files, and the stamp file if the streaming feature is in use.

Some examples are shown in this table.

Example Folder Name	Notes
\UPM_Profile\Data	The synchronized content of the Data folder in the user profile.
\UPM_Profile\AppData_upm_var	The synchronized content of the de-localized Application Data folder in the user profile. This folder is present during upgrades from Profile Management 4.x or earlier. Managing Version 1 profiles (of which Application Data is an example folder) is not supported in Profile Management 5.0.

Pending area

The user store includes the pending area. This area is a holding area used by the streamed user profiles and active write back features. All files are synchronized from the pending area to the user store after a user logs off from their last session. New sessions download files from both the user store and the pending area, so the user always experiences an up-to-date profile.

If a server becomes unresponsive, a timeout can be set that releases files in the pending area back to the user store (if configured as part of the streamed user profiles feature).

Folder structure of the user store with multiple platforms

When using the cross-platform settings feature, multiple platforms are involved. You must define platform-specific folders to separate the profiles for each platform. Typically, you do this using Profile Management variables in the Path to user store policy (for example, using %USER-NAME%\!CTX_OSNAME!!CTX_OSBITNESS! in the path).

The cross-platform settings store holds the settings for supported applications after the cross-platform settings feature is configured. You specify the name and location of the store during

configuration (using the Path to cross-platform settings store policy). The store holds the subset of the user's settings that roam between operating systems.

For example, you might want to roam settings between Windows XP and Windows 7. The platform-specific folders contain the user settings that are unique to Windows XP and Windows 7. The cross-platform settings store contains the subset of the settings that roam between these operating systems. At logon, this subset is copied into, and remains part of, the platform-specific folders. At logoff, any changes to the subset are extracted and placed back into the cross-platform settings store.

Each platform-specific folder contains standard subfolders (for example, UPM_Profile). For more information, see Folder structure of the user store. In addition, the UPM_CPS_Metadata subfolder is present. This system-created folder contains temporary settings that are shared across operating systems.

The user store and AD forests

Citrix user profiles cannot be managed across forests. They can be managed across domains in the same forest allowing multiple users with the same logon name to access the same resources in the forest. This involves uniquely identifying profiles with the %USERDOMAIN% and %USERNAME% variables in the path to the user store.

However, in this case you must use variables to disambiguate identical logon names when setting the path to the user store. To do this, append the domain name variable to the path. You must also set permissions on the user store and enable Profile Management's Processed Groups setting using Active Directory's Universal Groups.

You can use a manually defined system variable such as %ProfVer% to set the operating system version. Or you can use a Profile Management variable to set the operating system name, bitness, or the profile version. For examples of user store paths in AD forests, see [Specify the path to the user store](#).

Localizing the user store

The following table provides an overview of how Profile Management localizes and de-localizes folders when profile data is moved to and from the user store. Only folder names are localized and de-localized. For example, Start menu entries and registry settings are not translated into the correct language by Profile Management.

This information is relevant only when upgrading from Profile Management 4.x or earlier, when Version 1 profiles might be present. Managing Version 1 profiles is not supported in Profile Management 5.0.

Version 1 English Folder	User Store Folder	Full Path Relative to the User Profile
Accessibility	Accessibility_upm_var	\Start
Accessories	Accessories_upm_var	Menu\Programs\Accessories
Administrative Tools	AdminTools_upm_var	\Start Menu\Programs
Application Data	AppData_upm_var	\Start Menu\Programs
Cookies	Cookies_upm_var	\Local Settings
Desktop	Desktop_upm_var	
Entertainment	Entertainment_upm_var	
Favorites	Favorites_upm_var	\Start
History	History_upm_var	Menu\Programs\Accessories
Links	Links_upm_var	
Local Settings	LocalSettings_upm_var	\Local Settings
My Documents	MyDocuments_upm_var	\Favorites
My Music	MyMusic_upm_var	
My Pictures	MyPictures_upm_var	
My Videos	MyVideos_upm_var	\My Documents
NetHood	NetHood_upm_var	\My Documents
PrintHood	PrintHood_upm_var	\My Documents
Programs	Programs_upm_var	
Recent	Recent_upm_vars	
Start Menu	StartMenu_upm_var	\Start Menu
Templates	Templates_upm_var	
Temporary Internet Files	TemporaryInternetFiles_upm_var	
SendTo	SendTo_upm_var	
Startup	Startup_upm_var	\Local Settings
System Tools	SystemTools_upm_var	\Start Menu\Programs
		\Start
		Menu\Programs\Accessories

Profile Management use cases

August 6, 2024

Citrix Profile Management can be implemented to manage users' profiles in different scenarios regardless of how applications are delivered to users or where they are housed. The following are examples

of these scenarios:

- Citrix Virtual Apps with published applications
- Citrix Virtual Apps with published desktops
- Citrix Virtual Apps with applications streamed into an isolation environment
- Applications streamed to Citrix virtual desktops
- Applications installed on Citrix virtual desktops
- Applications streamed to physical desktops
- Applications installed locally on physical desktops

Of these scenarios, Citrix sees the following as the most common use cases:

- **Multiple sessions** - The user accesses multiple Citrix virtual apps server silos and therefore has multiple sessions open. Note however that application isolation and streaming on the server are alternatives to server silos. This scenario is described in more detail in this topic.
- **“Last write wins” and roaming profile consistency issues** - The last write to the roaming profile causes all settings to be saved. Therefore, roaming profiles might not retain the right data if multiple sessions are open and interim changes are made. In addition, settings might not be written correctly to the profile as a result of network, storage issues, or other problems. This scenario is described in more detail in this topic.
- **Large profiles and logon speed** - Profile bloat can make user profiles unwieldy resulting in storage and management issues. Typically, during logon Windows copies the user’s entire profile over the network to the local user device. For bloated profiles, this behavior can prolong the user’s logon time.

Multiple sessions

Especially in large environments, it might be necessary for users to open multiple sessions to access different applications that are housed on different Citrix virtual apps servers, whether in the same farm or multiple farms. Where possible, consider application isolation or streaming to house applications on the same Citrix virtual apps server to allow users to access all applications from a single server and thus a single session. However, this might not be possible if a business unit controls specific servers or applications cannot be streamed.

Once it has been determined that it is indeed necessary for users to access applications from various Citrix virtual apps servers, the impact on profiles must be ascertained.

The following diagram illustrates an example where application settings can be lost when multiple sessions exist.

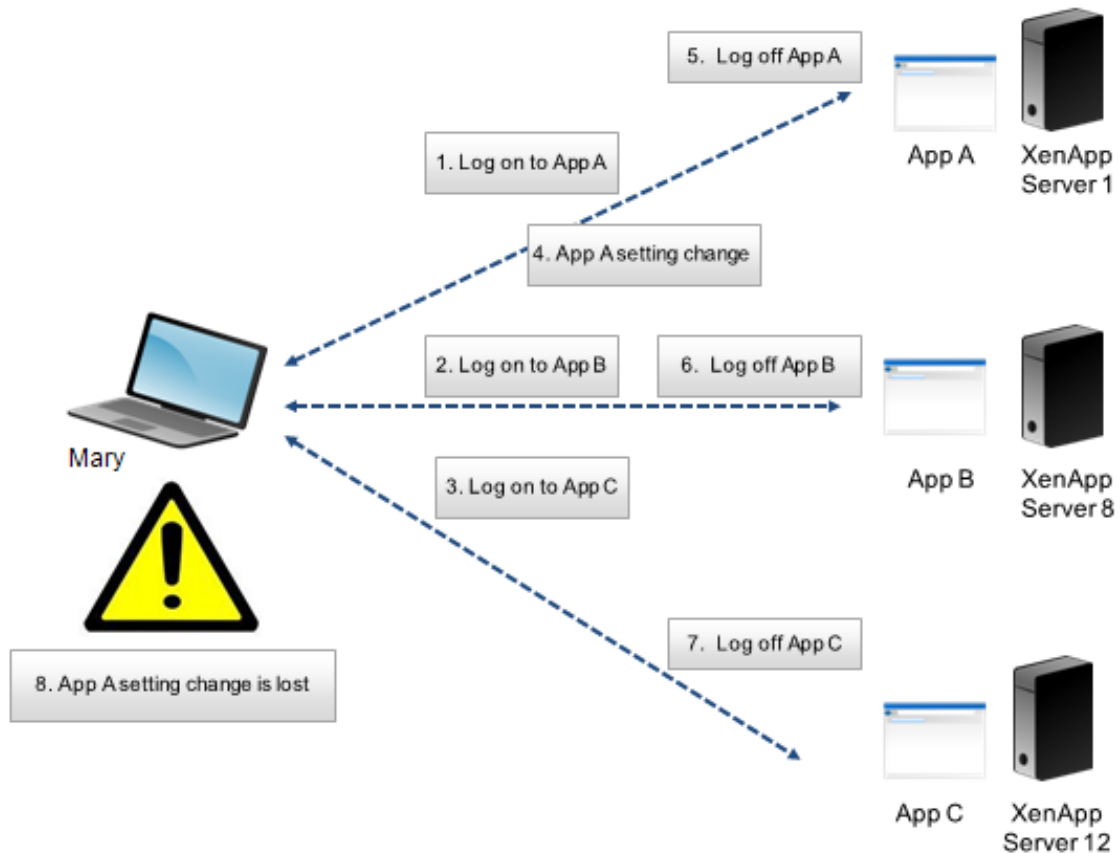

For example, Mary wants to access App A, App B, and App C and she is routed to Server 1, Server 8, and Server 12 respectively. Upon logon to each application, Mary’s Terminal Services roaming profile is loaded onto each server and folders are redirected for each session. When Mary is logged on to App A on Server1, Mary changes Setting1 and logs off that session. Mary then completes work in the other two applications and logs off.

At logoff, the change that Mary made within the session on Server 1 is overwritten because the settings within the last closed session are retained, not the interim change. When Mary logs on to App A the next day, she is frustrated because the change she made is not visible.

Profile Management can generally prevent this situation from occurring. Profile Management only writes back the specific settings that were changed during a session; all other unchanged settings remain untouched. So the only potential conflict that would arise is if Mary changed Setting1 within another session. However, the user would likely expect that the most recent change was retained, which is the case, if Profile Management is used in this scenario.

“Last write wins” and roaming profile consistency issues

This scenario is similar to the first one in this topic. “Last write wins” issues can present themselves in various ways, and user frustration can mount as the number of devices accessed increases.

Because the roaming profile retains all profile data, except folders that have been redirected, the user profile can grow large. Not only does this add to the logon time because the profile must be downloaded, the potential for inconsistency grows during the write phase of the logoff, especially where network issues exist.

Profile Management enables specific data to be excluded from the user profile, enabling the user profile to be kept to a minimal size. Because only differences are written to the profile, the write phase of the logoff involves less data and is faster. Profile Management can be beneficial for applications that use profiles for temporary data but do not clean them up when the applications terminate.

Access multiple resources

August 6, 2024

Profiles become more complex as users access multiple resources. With profiles stored on a network, Microsoft Windows uses the registry to store user settings. Profiles are copied from the network to the local device at logon, and copied back to the network at logoff. On a daily basis, users access multiple computers, switch between desktops and laptops, and access virtual resources created with Citrix Virtual Apps and Desktops or Citrix DaaS (formerly Citrix Virtual Apps and Desktops service).

This diagram illustrates how a single Citrix user profile follows a user who logs on to multiple resources.

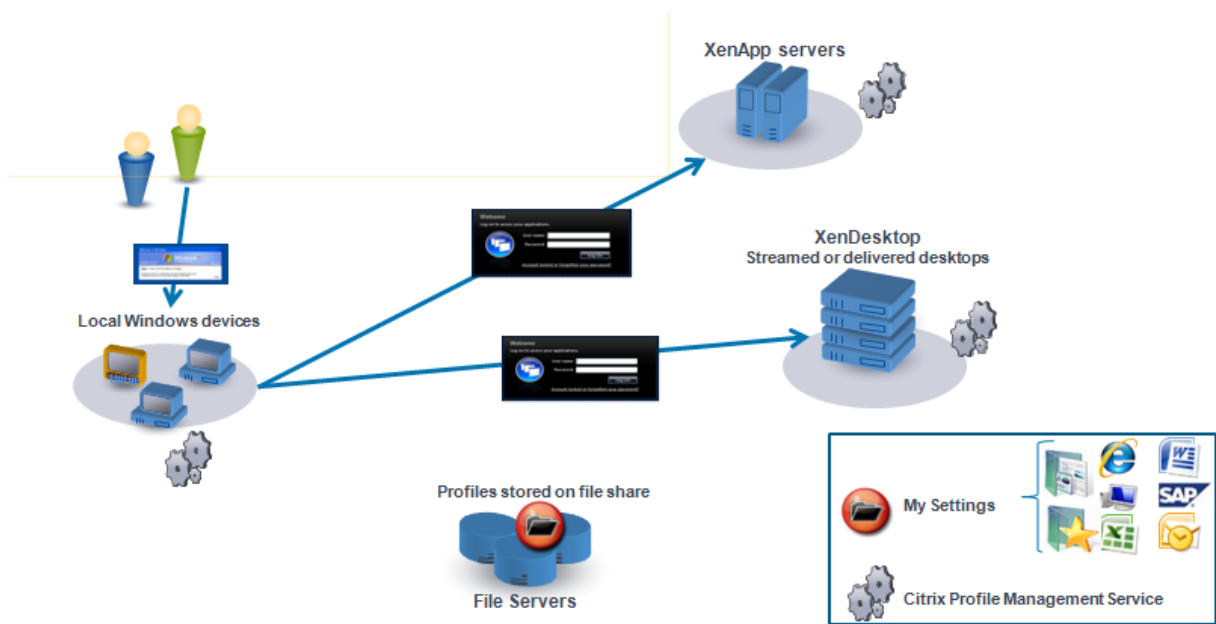

For example, a user has a local, physical desktop and from it accesses applications published with Citrix Virtual Apps. They also access a virtual desktop created with Citrix Virtual Desktops. The user's settings are not uniform across all of these resources unless the settings are appropriately configured.

In addition, when they access a shared resource, the behavior of roaming profiles means that the “last write wins.” For example, an administrator enables a roaming profile and a user changes the background color of the local desktop. The user then logs on to a Citrix virtual desktop, logs off the local desktop, and logs off the virtual desktop. Both the local and virtual desktops were open at the same time and the last logoff was from the virtual desktop. Therefore, the settings from the virtual desktop session were the last written to the profile, and the change to the background color is lost.

Logon diagram

August 6, 2024

This diagram helps you work out the details of your user profile migration strategy. It also explains these aspects of performance:

- When you migrate a profile, two network copies can take place, which slows down the logon process. For example, the operation **Copy default profile to local Pm profile and to user store** involves the following two copies: one full profile copy from the roaming profile store to the local computer and the other full profile copy from the local computer to the user store.
- When a cached profile is used, no copying of profile data across the network takes place.

Read the diagram from the bottom to the top. Check the desired operations in the boxes at the bottom (for example, **Copy default profile to local Pm profile and to user store**. And then track a path back to identify the required migration settings.

Logoff diagram

August 6, 2024

This diagram describes the logic used to copy or merge profile data at logoff.

CAPTION
 "Pm" indicates a Citrix user profile processed by Profile management.

Group Policy Settings
 (1) Conflict handling for local profiles [use|delete|rename] [default=use]
 (2) Migration of existing profiles [none|local|roaming|local+roaming] [default=local+roaming]
 (3a) Template path [default=empty]
 (3b) Template overwrites local profile [default=no]
 (3c) Template overwrites roaming profile [default=no]
 (4) Enable Profile management

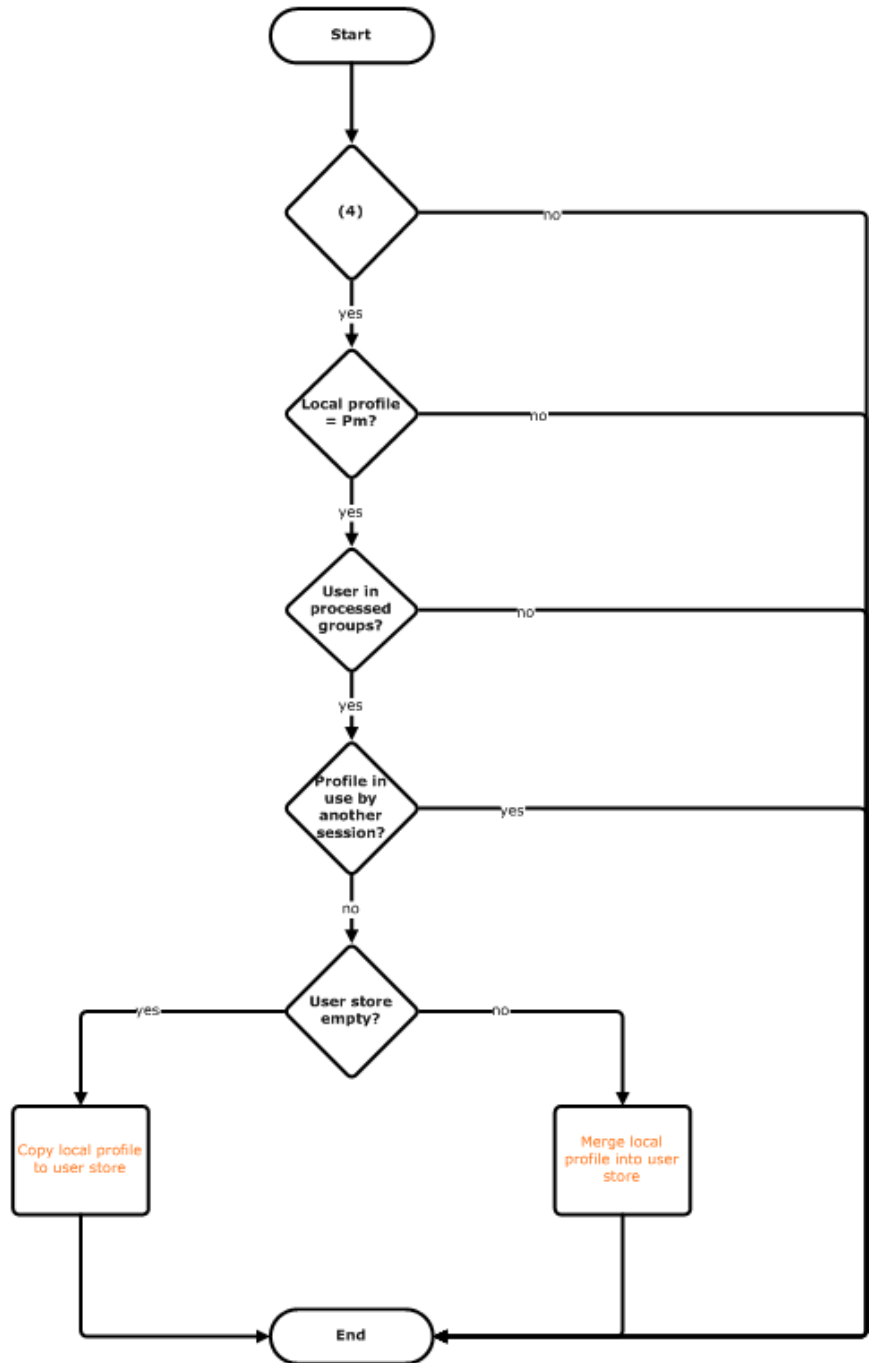

Plan your deployment

August 6, 2024

To plan a Profile Management deployment, you decide on a set of policy settings that together form a configuration that is suitable for your environment and users. The automatic configuration feature simplifies some of this decision-making for Citrix virtual desktops deployments. As a guide to carrying out this important task on any deployment, see [Decide on a configuration](#).

Having decided on a configuration, and reviewed and tested it, a typical deployment then consists of:

1. Creating the user store
2. Installing Profile Management
3. Enabling Profile Management

Plan a pilot study with the .ini file

The following information is intended to assist you using the Profile Management .ini file during a pilot study or evaluation.

Important: If you intend to use the .ini file (UPMPolicyDefaults_all.ini) for evaluation purposes, rename the file before you switch to using Group Policy (GP) in a production environment. For example, rename the file to UPMPolicyDefaults_all_old.ini. Renaming the file allows you to be certain that only production settings are applied, and that no settings you specified during your evaluation are used.

If the file is not renamed, Profile Management examines it for any settings not configured in Group Policy and adopts any non-default settings it finds. So, to eliminate the risk of unwanted settings being introduced, configure all the settings you want to use in your production environment using Group Policy, not the .ini file.

The .ini file contains the same policies as the .adm and .admx files, but the policies have different names. If you are familiar with the names in GP and planning a pilot study with the .ini file, compare the names using the tables in [Profile Management policies](#).

For more information on .ini file deployments, see [Upgrade Profile Management](#) and [Test Profile Management with a local GPO](#).

Decide on a configuration

August 6, 2024

To configure Profile Management, the recommended approach is to answer these basic questions about your environment:

1. [Pilot or production](#)
2. [Migrate or create profiles](#)
3. [Persistent or provisioned and dedicated or shared](#)
4. [Mobile or static](#)
5. [Which applications are in use](#)

Based on your answers, configure Profile Management for your deployment. You can leave all other policies as default.

Next steps

- [Install and set up](#)
- [Troubleshoot](#)

Tips

Refer to the following tips when checking and deploying Profile Management settings.

Check settings using the UPMConfigCheck tool

UPMConfigCheck is a PowerShell script that examines a live Profile Management deployment and determines whether it's optimally configured. For more information, see Knowledge Center article [CTX132805](#).

Group computers into OUs

If your answers to the questions are the same for different sets of computers, consider grouping them into an Active Directory Organizational Unit (OU). Also, consider configuring Profile Management by using a single Group Policy Object (GPO) attached to that OU.

If your answers to these questions are different, consider grouping the computers into separate OUs.

Alternatively, where a domain supports WMI filtering, you can group all computers into the same OU and use WMI filtering to select between appropriately configured GPOs.

Pilot or production

August 6, 2024

The aim of a pilot deployment is to be able to demonstrate a solution quickly and reliably. An important goal might be to reduce the number of components in the pilot. For Profile Management, two components are the user store and the selection of users whose profiles are processed.

Policy: Path to user store

Setting up a user store for Citrix user profiles is exactly like setting up a profile store for Windows roaming profiles.

For a pilot deployment, you can often ignore these considerations. The default value for the Path to user store policy is the **Windows** folder in the user's home directory. This works well for a single-platform pilot so long as only one operating system (and therefore only one profile version) is deployed. For information on profile versions, see [About profiles](#). This option assumes that enough storage is available in users' home directories and that no file-server quotas are applied. Citrix does not recommend the use of file-server quotas with profiles. The reasons for this are given in [Share Citrix user profiles on multiple file servers](#).

For a production deployment, you must carefully consider security, load balancing, high availability, and disaster recovery. Follow the recommendations in these topics for creating and configuring the user store:

- [Profile Management architecture](#)
- [Create the user store](#)
- [Specify the path to the user store](#)
- [High availability and disaster recovery with Profile Management](#)

Policies: Processed groups, Excluded groups

The complexity of production deployments means that you might need to phase the rollout of Profile Management, rather than release it to all users at the same time. You might tell users that they receive different profile experiences when connecting to different resources while the deployment is in the process of being rolled out.

For performance reasons, Profile Management is licensed by an EULA not built-in license checking. You might choose to manage license allocation by assigning users to an Active Directory (AD) user group or using an existing AD group if a suitable one exists.

In pilot deployments, use of Profile Management is restricted by invitation to a small group of users, possibly from several departments, where no single, representative AD group can be used. In this case, leave the Processed groups and Excluded groups policies unconfigured. Profile Management performs no checking on group membership and all users are processed.

For more information on these policies, see [Define which groups' profiles are processed](#).

Important: In all cases, you must ensure that the number of users processed by Profile Management does not exceed the limits set by the relevant EULA.

Migrate or create profiles

August 6, 2024

You can take advantage of a Profile Management deployment to refresh your organization's profiles, initially using a small, customized profile, and rigidly controlling additions to it. Alternatively, you might need to migrate existing profiles into the Profile Management environment and preserve the personalizations that have built up over many years.

If you decide to migrate existing profiles, configure the Migration of existing profiles and the Local profile conflict handling policies.

The following diagram illustrates how to configure these policies based on your answer to this question.

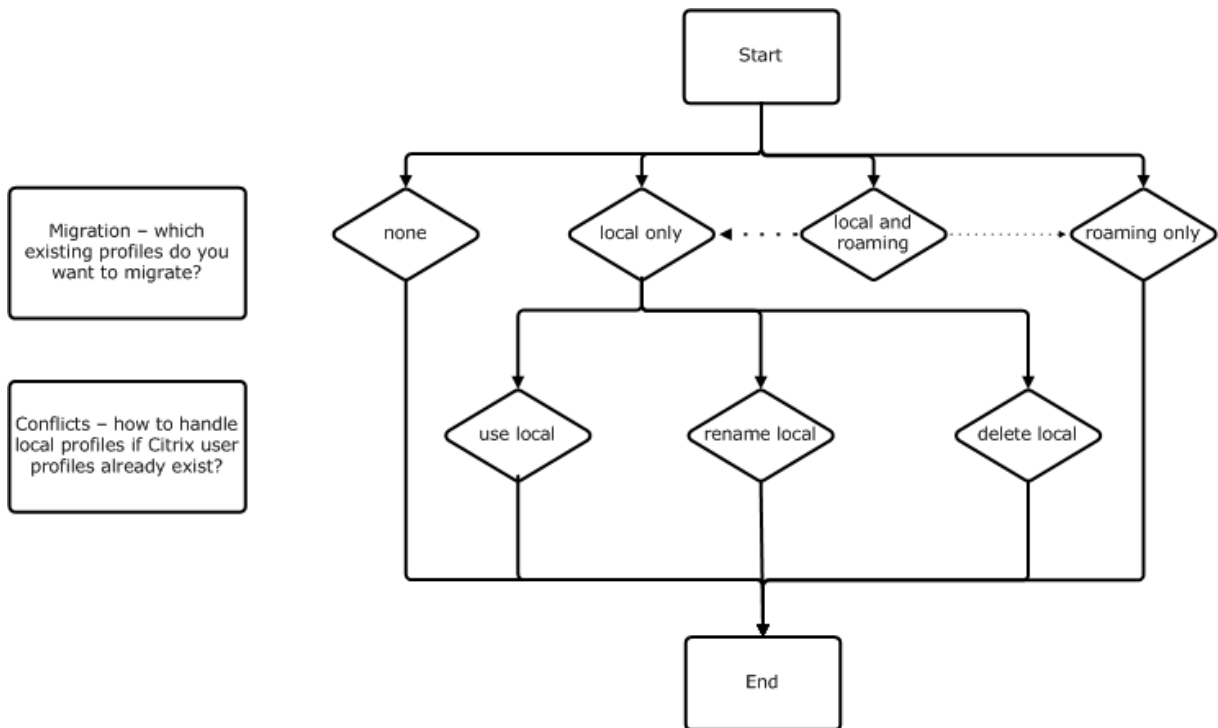

Policy: Template profile

If you decide to create an entirely new set of profiles, consider creating a template for this purpose using the Template profile policy. For information, see [Specify a template or mandatory profile](#). If you do not create a template, Profile Management gives users the default Windows profile. If no template is required, leave this policy disabled.

The **Template profile** policy is similar to the **Path to user store** policy. This policy specifies the location of a profile that can be used as the basis for creating a user profile when the user first logs on to a computer managed by Profile Management.

You can optionally use the template as a Citrix mandatory profile for all logons. As part of your planning, you must perform tasks such as identifying the applications that users access. You must configure the registry states, shortcuts, and desktop settings in the profile accordingly. You must set permissions on profile folders and modify users' logon scripts.

Note:

When selecting mandatory profiles in Citrix virtual desktops deployments, we recommend that you use Citrix Studio rather than the Profile Management .adm or .admx file.

Persistent or provisioned and dedicated or shared

August 6, 2024

The types of machines that create profiles affect your configuration decisions. The primary factors are whether machines are persistent or provisioned, and whether they are shared by multiple users or dedicated to just one user.

Persistent systems have some type of local storage, the contents of which can be expected to persist when the system turns off. Persistent systems might employ storage technology such as SANs to provide local disk mimicking. In contrast, provisioned systems are created “on the fly” from a base disk and some type of identity disk. Local storage is usually mimicked by a RAM disk or network disk, the latter often provided by a SAN with a high-speed link. The provisioning technology is generally Provisioning Services or Machine Creation Services (or a third-party equivalent). Sometimes provisioned systems have persistent local storage, which might be provided by Personal vDisks. They are classed as persistent.

Together, these two factors define the following machine types:

- **Both persistent and dedicated** - Examples are single-session OS machines with a static assignment and a Personal vDisk that are created with Machine Creation Services (in Citrix virtual desktops), desktops with Personal vDisks that are created with physical workstations and laptops.

- **Both persistent and shared** - Examples are multi-session OS machines that are created with Machine Creation Services (in Citrix virtual desktops), and Citrix virtual apps servers.
- **Both provisioned and dedicated** - Examples are single-session OS machines with a static assignment but without a Personal vDisk that are created with Provisioning Services (in Citrix virtual desktops).
- **Both provisioned and shared** - Examples are single-session OS machines with a random assignment that are created with Provisioning Services (in Citrix virtual desktops), desktops without Personal vDisks that are created with Citrix virtual apps servers.

The following Profile Management policy settings are suggested guidelines for the different machine types. They usually work well, but you might want to deviate from them as your deployment requires.

Note: In Citrix virtual desktops deployments, Delete locally cached profiles on logoff, Profile streaming, and Always cache are enforced by the auto-configuration feature.

Policy	Both persistent and dedicated	Both persistent and shared	Both provisioned and dedicated	Both provisioned and shared
Delete locally cached profiles on logoff	Disabled	Enabled	Disabled (note 5)	Enabled
Profile streaming	Disabled	Enabled	Enabled	Enabled
Always cache	Enabled (note 1)	Disabled (note 2)	Disabled (note 6)	Disabled
Active write back	Disabled	Disabled (note 3)	Enabled	Enabled
Process logons of local administrators	Enabled	Disabled (note 4)	Enabled	Enabled (note 7)

Notes

1. Because Profile streaming is disabled for this machine type, the Always cache setting is always ignored.
2. Disable Always cache. However, you can ensure that large files are loaded into profiles as soon as possible after logon by enabling this policy and using it to define a file size limit (in MB). Any file this size or larger is cached locally as soon as possible.
3. Disable Active write back except to save changes in profiles of users who roam between Citrix virtual apps servers. In this case, enable this policy.
4. Disable Process logons of local administrators except for Hosted Shared Desktops. In this case, enable this policy.

5. Disable Delete locally cached profiles on logoff. This retains locally cached profiles. Because the machines are assigned to individual users, logons are faster if their profiles are cached.
6. Disable Always cache. However, you can ensure that large files are loaded into profiles as soon as possible after logon by enabling this policy and using it to define a file size limit (in MB). Any file this size or larger is cached locally as soon as possible.
7. Enable Process logons of local administrators except for profiles of users who roam between Citrix virtual apps servers. In this case, disable this policy.

Mobile or static

August 6, 2024

Are your machines permanently connected to the Active Directory domain? Laptops and similar mobile devices probably are not. Similarly, some deployments might have fixed machines with persistent local storage but the machines are separated from the data center for significant periods of time. For example, a remote branch office is linked to the corporate headquarters by satellite communications. Another example is disaster recovery, where infrastructure is being restored and power or communications are intermittent.

Typically, Profile Management is resilient to short network outages (less than 24 hours) so long as the user does not log off while the network is unavailable. In these circumstances, you can optimize Profile Management in several ways that significantly speed up the logon process. This is the static case.

Where extended periods of disconnection are expected or users must be able to log off or shut down their computers while disconnected from the corporate network, you cannot optimize Profile Management. When users reconnect, logons are slow while the entire profile is fetched from the user store. This is the mobile case.

The mobile case

For extended periods of disconnection (and only intermittent periods of connection to the Active Directory domain), enable the Offline profile support policy. This approach automatically disables the effect of the following policies, controlling optimizations that are not supported. The policies might not appear to be disabled in Group Policy but they have no effect:

- Profile streaming
- Always cache

Note: If

Offline profile support is enabled,

Active write back is honored but can only work when the computer is connected to the network.

The static case

Policy: Offline profile support

For short periods of disconnection, disable the Offline profile support policy. This allows the configuration of any of the following policies.

Policy: Streamed user profile groups

Set the Streamed user profile groups policy to Unconfigured. Enabling this policy is effective only if Profile streaming is also enabled. Streamed user profile groups is used to limit the use of streamed profiles to specific Active Directory user groups. It is useful in some scenarios when migrating from older versions of Profile Management. For instructions on setting this policy, see [Stream user profiles](#).

For information on high availability and disaster recovery as it applies to this policy, see [Scenario 4 - The traveling user](#).

Policy: Timeout for pending area lock files

Set the **Timeout for pending area lock files** policy to Unconfigured to apply the default operation, which is a one-day timeout for the pending area lock. This is the only supported value, so do not adjust this policy.

Policy: Active write back

For information on this policy, see [Persistent or provisioned and dedicated or shared](#)

Which applications are in use

August 6, 2024

The applications in use in your deployment affect how you configure Profile Management. However, in contrast to the other configuration decisions you make, there are no simple yes-or-no recommendations. Your decisions depend on where the applications store persistent customizations (in the registry or in the file system).

Analyze and understand your users' applications thoroughly to establish where the applications store their settings and users' customizations. Use a tool such as Process Monitor to monitor application binaries. Google is another resource. For information on Process Monitor, see <https://docs.microsoft.com/en-us/sysinternals/downloads/procmon>.

Once you understand how the applications behave, use inclusions to define which files and settings are processed. Use exclusions to define which aren't. By default, everything in a profile is processed except for files in AppData\Local. You might need to include the subfolders of AppData\Local explicitly when your deployment includes any of the following applications:

- DropBox
- Google Chrome
- Applications created with the one-click publish in Visual Studio

Simple applications

Simple applications are those applications that are well behaved. They store personalization settings in the HKCU registry hive and personalization files within the profile. Simple applications require basic synchronization, which in turn requires you to include and exclude items using:

- Relative paths (relative to %USERPROFILE%) in these policies:
 - Directories to synchronize
 - Files to synchronize
 - Exclusion list - directories
 - Exclusion list - files
 - Folders to mirror

Note: %USERPROFILE% is implied by Profile Management. Do not add it explicitly to these policies.

- Registry-relative paths (relative to the HKCU root) in these policies:
 - Exclusion list
 - Inclusion list

For instructions on including and excluding items, see [Include and exclude items](#).

Legacy applications

Legacy applications are badly behaved; they store their personalization files in custom folders outside the profile. The recommended solution is not to use Profile Management with legacy applications but instead to use the Personal vDisk feature of Citrix Virtual Desktops.

Complex applications

Complex applications require special treatment. The application's files can cross-reference each other and must be treated as an inter-related group. Profile Management supports two behaviors associated with complex applications: cookie management and folder mirroring.

Cookie management in Internet Explorer is a special case of basic synchronization in which both of the following policies are always specified:

- Process Internet cookie files on logoff
- Folders to mirror

For more information on folder mirroring, cookie management, and instructions on setting these policies, see [Manage transactional folders](#).

Cross-platform applications

Cross-platform applications are the applications that might be hosted on multiple platforms. For specific versions of Internet Explorer and Microsoft Office, Profile Management supports sharing of personalization settings across platforms. Those settings are stored either in the registry or as files in the profile.

Recommended policy settings for cross-platform applications are documented at [Cross-platform settings - Case study](#).

If you want to share other applications' settings across platforms, we recommend you use Profile Migrator from Sepago.

Java and Web Applications

Java applications can leave many small files in a profile, which can dramatically increase profile load times. Thus, consider excluding `AppData\Roaming\Sun\Java`.

Summary of policies

The following table summarizes the policies you use to configure Profile Management for different types of applications. The following terms are used in the table:

- **Relative.** A relative path on a local volume, relative to %USERPROFILE% (which must not be specified). Examples: `AppData\Local\Microsoft\Office\Access.qat`, `AppData\Roaming\Adobe\`.
- **Absolute.** An absolute path on a local volume. Examples: `C:\BadApp*.txt`, `C:\BadApp\Database\info.db`.

- **Registry Relative.** Refers to a path within the HKCU hive. Examples: Software\Policies, Software\Adobe.
- **Flag.** Uses flags to enable or disable processing where no path information is required. Examples: Enabled, Disabled.

Policy	Policy Type (Registry, Folder, or File)	Wildcard Support?	Application Type - Simple	Application Type - Legacy	Application Type - Complex
Directories to synchronize	Folder	Yes	Relative	Absolute	
Files to synchronize	File	Yes	Relative	Absolute	
Exclusion list - directories	Folder	Yes	Relative	Absolute	
Exclusion list - files	File	Yes	Relative	Absolute	
Inclusion list	Registry		Registry relative		
Exclusion list	Registry		Registry relative		
Folders to Mirror	Folder			Absolute	Relative
Process Internet cookie files on logoff					Flag

Wildcard processing in file and folder names

Policies that refer to files and folders (rather than registry entries) support wildcards. For more information, see [Use wildcards](#).

Inclusion and exclusion rules

Profile Management uses rules to include and exclude files, folders, and registry keys from user profiles in the user store. These rules result in sensible and intuitive behavior. All items are included by default. From that starting point, you can configure top-level exceptions as exclusions, then configure deeper exceptions to the top-level exceptions as inclusions, and so on. For more information on the rules, including instructions on including and excluding items, see [Include and exclude items](#).

Non-English folder names in profiles

For non-English systems that use Version 1 profiles, specify relative paths in the inclusion and exclusion lists in the local language. For example, on a German system, use **Dokumenten** not **Documents**. If you support multiple locales, add each included or excluded item in each language.

Next steps

1. Answer all question listed in [Decide on a configuration](#).
2. Based on your answers, configure Profile Management for your deployment. You can leave all other policies as default.
3. Test and review the settings, and then enable Profile Management, as described in [Test Profile Management with a local GPO](#).

Plan for multiple platforms

August 6, 2024

Why are user profiles on multiple platforms such a challenge?

It is common for users to access multiple computing devices. The challenge with any type of roaming profile results from the differences between systems on these devices. For example, if I create a shortcut on my desktop to a local file that does not exist when I move to a different device, I have a broken shortcut on my desktop.

A similar issue exists when roaming between a single-session operating system (OS) and a multi-session OS. Some settings might not be applicable on the server (such as power settings or video settings). Furthermore, if applications are not installed similarly on each device, when I roam other issues might emerge.

Some personalization settings (such as My Documents, Favorites, and other files that function independently of OS or application version) are much easier to manage than others. But even these settings might be difficult to roam when a document type is only supported on one system. For example, a user has Microsoft Project installed on one system, but on another device that file type is not recognized. This situation is exacerbated if the same application is present on two systems but on one system, different add-ons are installed and expected by a document.

How does changing the way an application is installed cause issues?

Even though the platforms are installed identically, if an application is configured differently on each, errors might occur when the application starts. For example, a macro or add-on might activate in Excel on one platform but not another.

The Start menu

The Start menu contains links (LNK and LNK2 files). The user-specific part of the menu is stored in the profile and users can modify that part of the menu. Adding custom links (to executables or documents) is common. In addition, links that are language-specific result in multiple Start menu entries for the same application. Furthermore, links pointing to documents might be invalid on other computers. The reason is that the path to the document is relative to another system, or it is a network path that is inaccessible.

By default, Profile Management does not save the content of the Start menu folder because links pointing to executables are often computer-dependent. However, in situations where the systems are similar, including the Start menu in your Profile Management configuration improves the consistency when users roam from desktop to desktop. Alternatively, you can process the Start menu with folder redirection.

Note: Unpredictable side effects can often result from what appears to be the most innocuous of changes. For example, see the article at <https://helgeklein.com/blog/2009/09/citrix-user-profile-manager-upm-and-the-broken-rootdrive/> on the Sepago blog.

Always test and verify the behavior of the Start menu across platforms.

The Quick Launch toolbar

The **Quick Launch** toolbar contains links and is configurable by users. By default, the **Quick Launch** toolbar is saved by Profile Management. In some environments, saving the **Quick Launch** toolbar might not be desirable because the links might be computer-dependent.

To exclude the toolbar from profiles, add the following entry to the folder exclusion list: AppData\Roaming\Microsoft\Internet Explorer\Quick Launch.

What types of profiles to create?

Important: Because of the difference in their structure, we recommend creating separate Version 1 and Version 2 profiles for each user in any environment that contains multiple platforms. Differences between the Windows Vista and Windows 7 profile namespace make it difficult to share profiles across

these platforms. And failures can also occur between Windows XP and Windows Server 2003. For more information on Version 1 and Version 2 profiles, see

[About profiles.](#)

The definition of multiple platforms here includes not just multiple operating systems (including ones of different bitness) but also multiple application versions running on the same operating system. The following examples illustrate the reasons for this recommendation:

- 32-bit systems might contain registry keys that instruct the operating system to start applications in locations specific to 32-bit operating systems. If the keys are used by a Citrix user profile on a 64-bit system, the location might not exist on that system and the application fails to start.
- Microsoft Office 2003, Office 2007, and Office 2010 store some Word settings in different registry keys. Even if these applications run on the same operating system, you must create separate profiles for the three different versions of the Word application.

We recommend using Microsoft folder redirection with Citrix user profiles to help ensure profile interoperability. Within an environment where Windows Vista or Windows 7 must co-exist with Windows XP, it is even more important.

Tip: Depending on your organization's data management policy, it is good practice to delete profiles from the user store and the cross-platform settings store for user accounts that have been removed from Active Directory.

Share Citrix user profiles on multiple file servers

August 6, 2024

The simplest implementation of Profile Management is one in which the user store is on one file server that covers all users in one geographical location. This topic describes a more distributed environment involving multiple file servers. For information on highly distributed environments, see [High availability and disaster recovery with Profile Management](#).

Note: Disable server-side file quotas for the user store because filling the quota causes data loss and requires the profile to be reset. It is better to limit the amount of personal data held in profiles (for example, Documents, Music and Pictures) by using folder redirection to a separate volume that does have server-side file quotas enabled.

The user store can be located across multiple file servers, which has benefits in large deployments where many profiles must be shared across the network. Profile Management defines the user store with a single setting, **Path to user store**, so you define multiple file servers by adding attributes to this setting. You can use any LDAP attributes that are defined in the user schema in Active Directory.

For more information, see <https://docs.microsoft.com/en-us/windows/win32/adschema/attributes-all?redirectedfrom=MSDN>.

Suppose that your users are in schools located in different cities and the #l# attribute (lower case L, for location) is configured to represent this. You have locations in London, Paris, and Madrid. You configure the path to the user store as:

```
\\#l#.userstore.myschools.net\profile\#sAMAccountName#\%ProfileVer%
```

For Paris, this is expanded to:

```
\\Paris.userstore.myschools.net\profile\JohnSmith\v1\
```

You then divide up your cities across the available servers, for example, setting up Paris.userstore.myschools.net in your DNS to point to Server1.

Before using any attribute in this way, check all of its values. They must only contain characters that can be used as part of a server name. For example, values for #l# might contain spaces or be too long.

If you can't use the #l# attribute, examine your AD user schema for other attributes such as #company# or #department# that achieve a similar partitioning.

You can also create custom attributes. Use Active Directory Explorer, which is a [Sysinternals](#) tool, to find which attributes have been defined for any particular domain. Active Directory Explorer is available at <https://docs.microsoft.com/en-us/sysinternals/downloads/adexplorer>.

Note: Do not use user environment variables such as %homeshare% to distinguish profiles or servers. Profile Management recognizes system environment variables but not user environment variables. You can, however, use the related Active Directory property, #homeDirectory#. So, if you want to store profiles on the same share as the users' HOME directories, set the path to the user store as #homeDirectory#\profiles.

The use of variables in the path to the user store is described in the following topics:

- [Specify the path to the user store](#)
- [Administer profiles within and across OUs](#)
- [High availability and disaster recovery with Profile Management](#)

Administer profiles within and across OUs

August 6, 2024

Within OUs

You can control how Profile Management administers profiles within an Organizational Unit (OU). In Windows Server 2008 environments, use Windows Management Instrumentation (WMI) filtering to restrict the .adm or .admx file to a subset of computers in the OU. WMI filtering is a capability of the Group Policy Management Console with Service Pack 1 (GPMC with SP1).

For more information on WMI filtering, see [https://docs.microsoft.com/en-us/previous-versions/windows/it-pro/windows-server-2003/cc779036\(v=ws.10\)](https://docs.microsoft.com/en-us/previous-versions/windows/it-pro/windows-server-2003/cc779036(v=ws.10)) and [https://docs.microsoft.com/en-us/previous-versions/windows/it-pro/windows-server-2003/cc758471\(v=ws.10\)](https://docs.microsoft.com/en-us/previous-versions/windows/it-pro/windows-server-2003/cc758471(v=ws.10)).

For more information on GPMC with SP1, see <https://www.microsoft.com/en-us/download/details.aspx?id=21895>.

The following methods let you manage computers with different OSs using a single Group Policy Object (GPO) in a single OU. Each method is a different approach to defining the path to the user store:

- Hard-coded strings
- Profile Management variables
- System environment variables

Hard-coded strings specify a location that contains computers of just one type. This allows profiles from those computers to be identified by Profile Management uniquely. For example, if you have an OU containing only Windows 7 computers, you might specify `\server\profiles$\%USERNAME%.%USERDOMAIN%\Windows7` in **Path to user store**. In this example, the Windows7 folder is hard-coded. Hard-coded strings do not require any setup on the computers that run the Profile Management Service.

Profile Management variables are the preferred method because they can be combined flexibly to identify computers uniquely and do not require any setup. For example, if you have an OU containing Windows 7 and Windows 8 profiles running on operating systems of different bitness, you might specify `\server\profiles$\%USERNAME%.%USERDOMAIN%!CTX_OSNAME!!CTX_OSBITNESS!` in **Path to user store**. In this example, the two Profile Management variables might resolve to the folders Win7x86 (containing the profiles running on the Windows 7 32-bit operating system) and Win8x64 (containing the profiles running on the Windows 8 64-bit operating system). For more information on Profile Management variables, see [Profile Management policies](#).

System environment variables require some configuration. They must be set up on each computer that runs the Profile Management Service. Where Profile Management variables are not suitable, consider incorporating system environment variables into the path to the user store as follows.

On each computer, set up a system environment variable called %ProfVer%. (User environment variables are not supported.) Then, set the path to the user store as:

```
pre codeblock \\upmserver\upmshare\\%username%.%userdomain%\%ProfVer%
%
```

For example, set the value for %ProfVer% to Win7 for your Windows 7 32-bit computers and Win7x64 for your Windows 7 64-bit computers. For Windows Server 2008 32-bit and 64-bit computers, use 2k8 and 2k8x64 respectively. Setting these values manually on many computers is time-consuming, but if you use Provisioning Services, you only have to add the variable to your base image.

Tip: In Windows Server 2008 R2 and Windows Server 2012, you can speed up the creation and application of environment variables using Group Policy. In Group Policy Management Editor, click

Computer Configuration >

Preferences >

Windows Settings >

Environment, and then

Action >

New >

Environment Variable.

Across OUs

You can control how Profile Management administers profiles across OUs. Depending on your OU hierarchy and GPO inheritance, you can separate into one GPO a common set of Profile Management policies that apply to multiple OUs. For example, **Path to user store** and **Enable Profile Management** must be applied to all OUs. So you might store them separately in a dedicated GPO, enabling only these policies there (and leaving them unconfigured in all other GPOs).

You can also use a dedicated GPO to override inherited policies. For information on GPO inheritance, see the Microsoft website.

Domain and forest support in Profile Management

August 6, 2024

Profile Management supports the domain and forest functional levels of Windows Server 2008 and Windows Server 2012. Older operating systems are unsupported.

The use of system environment variables can help to disambiguate user names in multiple domains. For more information, see [Administer profiles within and across OUs](#).

High availability and disaster recovery with Profile Management

August 6, 2024

As a prerequisite, familiarize yourself with the structure of the user store and how to create it. For more information, see [Profile Management architecture](#) and [Create the user store](#).

These topics describe the supported scenarios for high availability and disaster recovery as they apply to Citrix Profile Management. It relates the scenarios to the relevant, underlying Microsoft technologies and identifies what is supported:

- [Scenario 1](#): Basic setup of geographically adjacent user stores and failover clusters
- [Scenario 2](#): Multiple folder targets and replication
- [Scenario 3](#): Disaster recovery
- [Scenario 4](#): The traveling user
- [Scenario 5](#): Load-balancing user stores

Profile Management assumes that it operates in an environment that is reliable. Principally, this reliability applies to the availability of Active Directory (AD) and a networked user store (NUS). When either is not available, Profile Management cannot provide a profile, and hands over responsibility to Windows, which generally provides a default profile.

Comparison with roaming profiles

In disaster recovery and high availability scenarios, Citrix Profile Management might be affected by the same issues as affect Microsoft roaming profiles. Unless stated to the contrary, Profile Management does not resolve such issues.

In particular, note the following:

- Profile Management support is limited to the scenarios where roaming profiles are also supported.
- The cache option for offline files must be disabled on roaming user profile shares. The same restriction applies to Profile Management shares.
- A roaming profile is not loaded from a DFS share. The same restriction applies to Profile Management shares. For more information, see <https://support.microsoft.com/en-us/help/2533009>.

Scenario 1 - Basic setup of geographically adjacent user stores and failover clusters

August 6, 2024

“I want my users to always use a geographically adjacent, preferred networked user store (NUS) for their profiles.” Options 1 and 2 apply in this case.

“I want my NUS to be on a failover cluster, to give me high availability.” Option 2 applies in this case.

The following graphic illustrates this scenario. Users in North America (NA) want to use the NUS in New York rather than the NUS in Brisbane. The aim is to reduce latency and to minimize the traffic sent over the intercontinental link to Australia or New Zealand (ANZ).

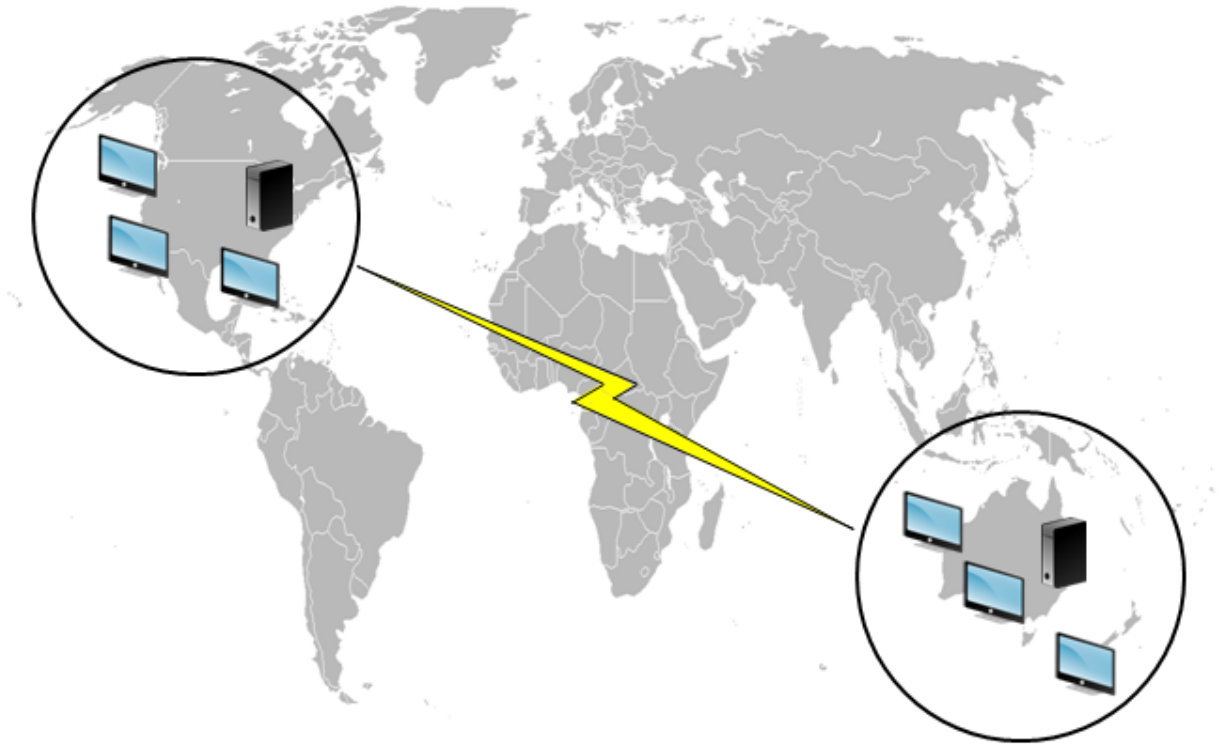

Option 1 –DFS Namespaces

Background reading

- For an overview of the Microsoft DFS Namespaces technology, see [DFS Namespaces overview](#).
- For advice on load balancing user stores, see the Citrix blog at <https://www.citrix.com/blogs/2009/07/21/profile-management-load-balancing-user-stores/>.

Implementing this option

DFS Namespaces can resolve some of the issues presented in the blog article.

Let us set up a namespace for the NUS called \\MyCorp\Profiles. It is the namespace root. We set up namespace servers in New York and Brisbane (and any of the other sites). Each namespace server has

folders corresponding to each Active Directory location, which in turn have targets on a server in New York or Brisbane.

We might have the following locations configured in Active Directory (part of the user records).

AD Location Attribute (#l#)	Geographic Location
Wagga Wagga	ANZ
Darwin	ANZ
Brisbane	ANZ
Auckland	ANZ
Seattle	NA
San Diego	NA
West Palm Beach	NA
Poughkeepsie, New York	NA

The following graphic shows one way of setting this up using DFS Namespaces.

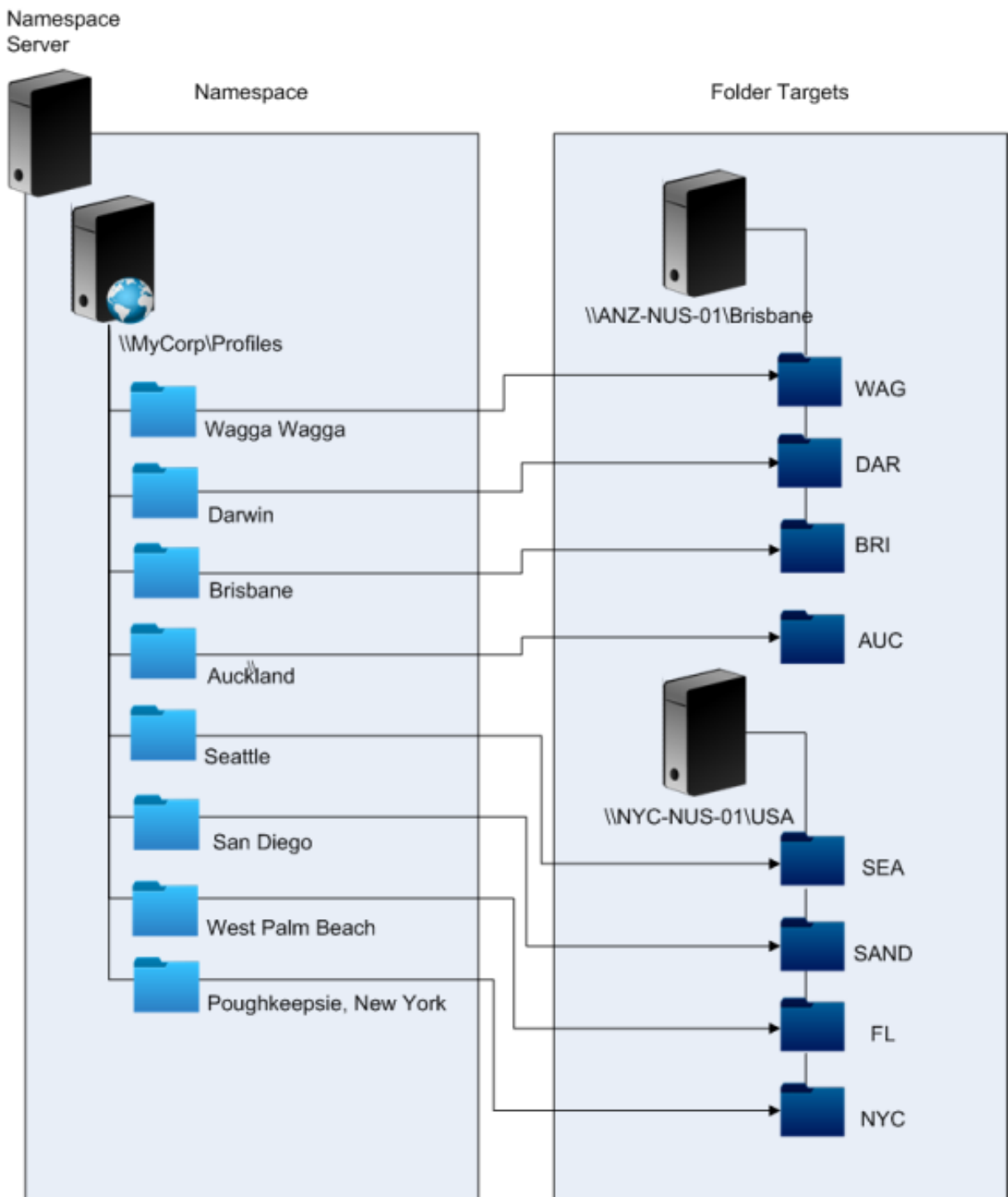

Once it is set up, we configure the Path to user store setting as:

`\\MyCorp\Profiles\#\#`

The profiles of users belonging to the eight sites are distributed to just two servers, meeting the geographical constraints required of the scenario.

Alternatives

You can order namespace targets and use the ordering rules as follows. When DFS Namespaces resolves which target to use, it is possible to specify that only targets in the local site are chosen. It works so long as you are sure that, for any given user, every desktop and server are guaranteed to belong to the same site.

This technique fails if, say, a user normally based at Poughkeepsie visits Wagga Wagga. Their laptop profile might come from Brisbane, but the profile used by their published applications might come from New York.

The recommended technique, using AD attributes, ensures that the same DFS Namespace choices are made for every session that the user initiates. The reason is that the #l# derives from the user's AD configuration rather than from machine configurations.

Option 2 - DFS Namespaces with failover clustering

Background reading

- For a step-by-step guide to configuring a two-node file server failover cluster, see [Deploying a two-node clustered file server](#).
- For information about choosing a namespace type, see <https://docs.microsoft.com/en-us/windows-server/storage/dfs-namespaces/choose-a-namespace-type>.

Implementing this option

Adding failover clustering allows you to provide basic high availability.

The key point in this option is to turn the file servers into failover clusters, so that folder targets are hosted on a failover cluster rather than a single server.

If you require the namespace server itself to have high availability, you must choose a standalone namespace. Domain-based namespaces do not support the use of failover clusters as namespace servers. Folder targets might be hosted on failover clusters, regardless of the type of namespace server.

Important: The state of file locks might not be preserved if a server in a failover cluster fails. Profile Management takes out file locks on the NUS at certain points during profile processing. It is possible that a failover at a critical point might result in profile corruption.

Scenario 2 - Multiple folder targets and replication

August 6, 2024

“If my local NUS is not available, I want my users to be able to get their profile data from a backup location somewhere else on the corporate network. If they make changes, those changes need to get back to their preferred NUS when it is available again.”

The basic requirement in this scenario is to provide alternative locations for profiles on the network. The use case includes the partial failure of the network infrastructure or the complete unavailability of a folder target such as a failover cluster.

Options you need consider are the use of multiple folder targets and the use of DFS replication.

Option 1 - Referrals to multiple folder targets

Background reading

For information about tuning DFS namespaces, see <https://docs.microsoft.com/en-us/windows-server/storage/dfs-namespaces/tuning-dfs-namespaces>.

About this option

A referral is an ordered list of targets that are tried in turn by a user device. It is designed for scenarios where the targets are read-only, such as software libraries. There is no linkage between targets, so using this technique with profiles might create multiple profiles that cannot be synchronized.

However, it is possible to define both an ordering method and a target priority for targets in referrals. Choosing a suitable ordering method appears to result in a consistent choice of target by all user sessions. But in practice, even when all of a user’s devices are within the same site, intra-site routing problems can still result in different targets being chosen by different sessions. This problem can be compounded when devices cache referrals.

Important: This option is not suitable for Profile Management deployments and is not supported. However, file replication has been used in some specialized deployments in which only a single session can be guaranteed and

Active write back is disabled. For information on these special cases, contact Citrix Consulting.

Option 2 - Distributed file system replication

Background reading

- For an overview of Distributed File System Replication (DFSR), see <https://docs.microsoft.com/en-us/windows-server/storage/dfs-replication/dfs-overview>.
- For a statement of support about replicated user profile data, see <https://techcommunity.microsoft.com/t5/ask-the-directory-services-team/microsoft-8217-s-support-statement-around-replicated-user/ba-p/398230>.
- To understand why DFSR does not support distributed file locking, see <https://blogs.technet.com/b/askds/archive/2009/02/20/understanding-the-lack-of-distributed-file-locking-in-dfs.aspx>.

Implementing this option

DFS Replication provides folder synchronization across limited bandwidth network connections. This option appears to solve the problems in Option 1 because it synchronizes multiple folder targets that a single namespace folder definition refers to. Indeed, when folders are added as targets to a folder definition, they can be specified as belonging to a replication group.

There are two forms of replication to consider:

- One-way replication (also known as active-passive replication) is designed for backing up critical data to a safe repository. This replication makes it suitable for maintaining a disaster recovery site, for example. It can be made to work with Profile Management so long as the passive targets are disabled for referrals, and are only invoked when the disaster recovery plan is activated.
- Two-way replication (also known as active-active replication) is intended to provide local read-write access to global shared data. Instantaneous replication is not necessarily a requirement here. The shared data might be modified infrequently.

Important: Active-active DFSR is not supported.

A schedule defines the frequency with which data is replicated. A frequent schedule is more intensive on both CPU and bandwidth, but does not guarantee instantaneous updates.

At various points in its operation, Profile Management requires certain files to be locked in the NUS to coordinate updates to the (shared) user store. Typically these updates take place when a session starts and ends, and in the middle of a session if active write-back is enabled. Since distributed file locking is not supported by DFS Replication, Profile Management can only select one target as an NUS. This set effectively eliminates any value of two-way replication (active-active replication), which is therefore not suitable for Profile Management and is not supported. One-way replication (active-passive

replication) is suitable for Profile Management only as part of a disaster recovery system. Other uses are not supported.

Scenario 3 - Disaster recovery

August 6, 2024

“How do I set up a full disaster recovery site to handle Citrix user profiles?”

Profile Management supports key features required for disaster recovery (DR) :

- **DFS namespaces.** Domain-based namespace servers are preferred in this scenario because they allow the DR site to have its own namespace server. (A standalone namespace server cannot be replicated, but it can be hosted on a failover cluster.)
- **Multiple folder targets and DFS Replication.** For each NUS, you provide at least two targets, but only enable one in normal operation. You set up one-way DFS Replication to ensure that the disabled targets (at the DR sites) are kept up-to-date.
- **Failover clusters for hosting individual folder targets.** Optional. It might be wasteful of resources on the DR site.

In this diagram, a domain-based namespace manages the NUS. (The diagram in Scenario 1 deliberately did not include namespaces.) You can include a namespace server in each site, including the DR site. The servers all support the same view of the namespace.

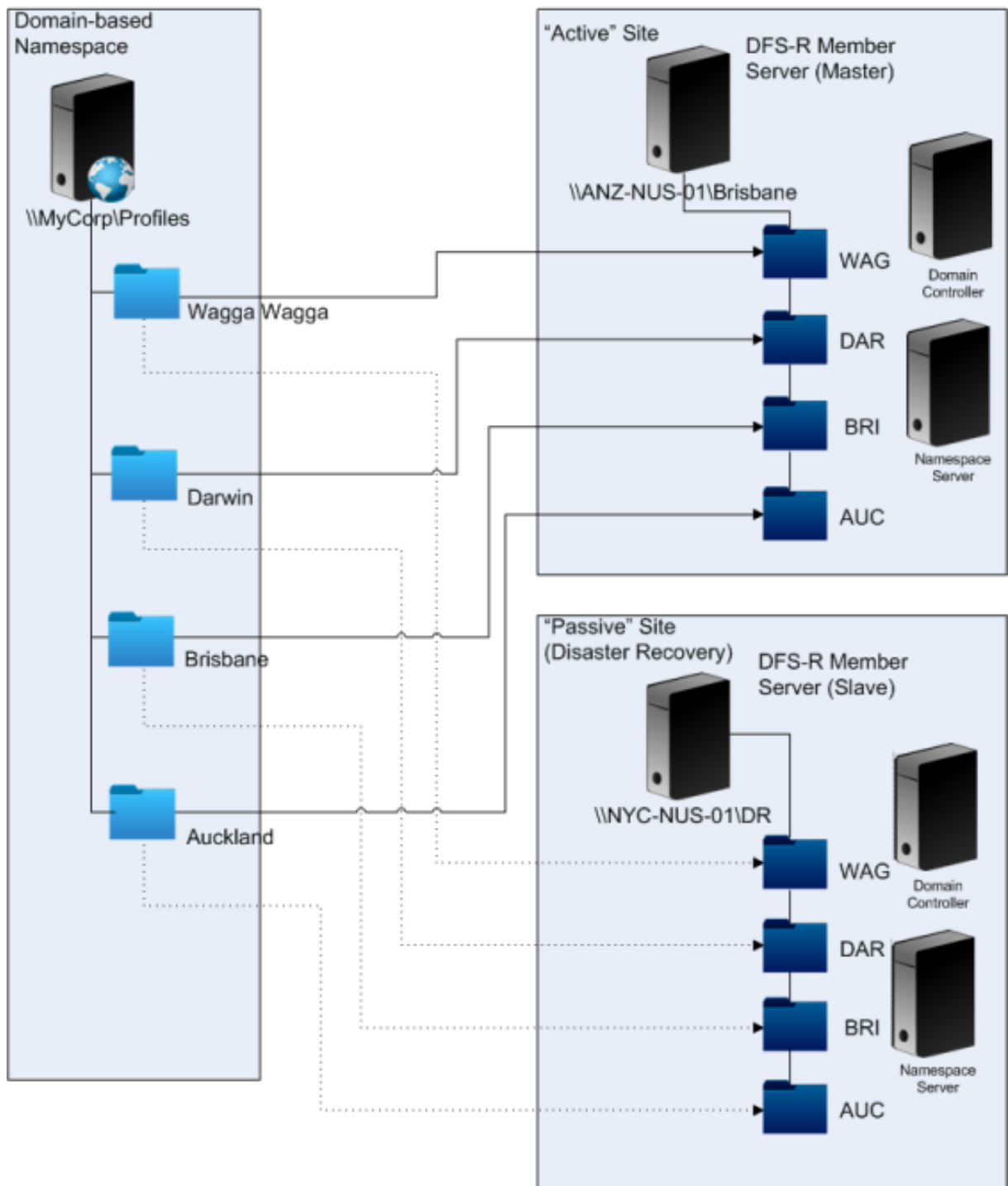

If the DR plan is activated, the DR site's NUS is up-to-date with the changes replicated from the master NUS. However, the namespace server still reflects the wrong view of the namespace, so its configuration must be updated. For each folder, the folder target on the master site must be disabled and the folder target on the DR site enabled.

After AD updates have propagated, the namespace server correctly locates the DR folder targets and

the DR site is ready to use by Profile Management.

Note: The

Path to user store setting refers to namespace folders, not real servers, so there is no need to update the Profile Management configuration.

In practice, one-way or two-way replication is possible because the DR site is not normally used for profiles. Once the disaster is over, a connection from the DR site to the master site ensures that changes made to the NUS during the disaster are replicated on the master site.

Scenario 4 - The traveling user

August 6, 2024

“When my staff roam between different offices, I want their preferred NUS to change, so that they’re still using a geographically adjacent NUS.”

The difficulty with this scenario is that a user’s logon session might be aggregated from multiple locations. They typically roam their desktop session from one site to another. But many of their applications are hosted on back-end servers that have no awareness of the current location of the user’s desktop.

Furthermore, the user might reconnect to disconnected sessions, probably hosted at their home location. If the sessions were for some reason forced to switch to an NUS in the user’s new location, their performance degrades.

For travelers who hot-desk, using the **Profile streaming** and **Always cache** settings is the best option. With a fixed machine, they still log on quickly, using Citrix streamed user profiles. Enabling Always cache loads the remainder of the profile in the background.

Scenario 5 - Load-balancing user stores

August 6, 2024

“I want to load-balance my users across several geographically adjacent networked user stores (NUSs).”

Background reading

- For an overview of the Microsoft DFS Namespaces technology, see [DFS Namespaces overview](#).

- For advice on load balancing user stores, see the Citrix blog at <https://blogs.citrix.com/2009/07/21/profile-management-load-balancing-user-stores/>.

Unlike Scenario 1, this scenario has a single site that is large enough to require multiple NUSs. Using DFS namespaces, we can improve on the solution in Scenario 1.

Scenario 1 (Option 1) used DFS Namespaces to map multiple sites to different folders on the same server. You can use a similar technique to map subfolders of a namespace to folders on different servers.

Ideally, you need an AD attribute that partitions user accounts into similarly sized chunks, such as #department#. As in Scenario 1, #department# must always be defined and must be guaranteed to contain a correct folder name.

As in Scenario 1, we set up a namespace for the NUS called \\MyCorp\Profiles.

This diagram shows how to set up the namespace.

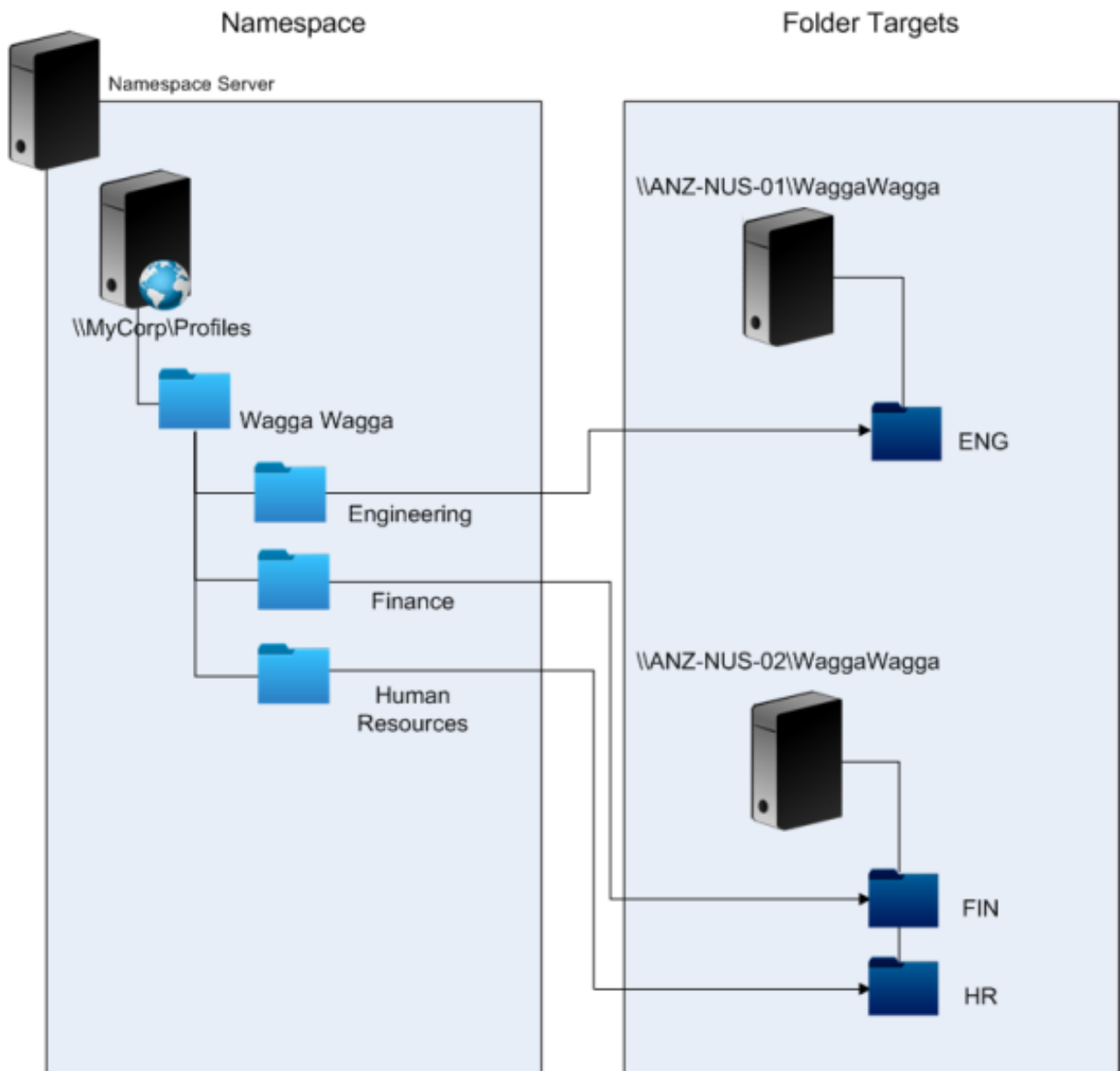

Once you complete the setup, you configure the Path to user store setting as:

`\\MyCorp\Profiles\#l#\#department#`

With this configuration, the users in Wagga Wagga are distributed across two NUS servers, both local.

Plan folder redirection with Profile Management

August 6, 2024

Profile Management supports folder redirection and its use is encouraged.

Active Directory (AD) allows folders, such as Application Data or Documents, to be saved (redirected) to a network location. The contents of the folders are stored in the redirected location and not included within the user profile, which therefore reduces in size. Depending on the version of AD, some folders can be redirected but not others. In addition, configuring folder redirection allows users with mandatory profiles to save some settings, files, and other data while still restricting profile usage.

As a general guideline, we recommend enabling folder redirection for all user data that is not accessed regularly within a session if network bandwidth permits.

Not all folders which can be redirected are accessible with AD. The folders that can be redirected on a specific operating system are in the registry under `HKEY_CURRENT_USER\SOFTWARE\Microsoft\Windows\CurrentVersion\Explorer\User Shell Folders`.

Important information about folder redirection

Note the following important points about using folder redirection with Profile Management:

- In XenDesktop 7, you specify the folders to redirect in Studio using Citrix Virtual Desktops policies. For more information, see the Citrix Virtual Desktops documentation.
- To configure folder direction successfully, be aware of the differences in folder structure between Version 1 and Version 2 profiles.
- For more security considerations when using folder redirection, see [Secure](#) and the article [Folder Redirection Overview](#) on the Microsoft TechNet website.
- Treat the user store differently to the share used for redirected folders.
- Do not add redirected folders to exclusion lists.

Watch this video to [learn more](#):



Third-party directory, authentication, and file services

August 6, 2024

This article describes support for directory, authentication, and file services other than those provided by Microsoft.

Directory services

Important: Active Directory (AD) is critical to the operation of Profile Management. Other directory services are not supported. These services include:

- Novell eDirectory.
- Windows 2000 server or earlier operating systems (OSs). Windows 2000 server supports AD but not at the required level; for more information, see [Domain and forest support in Profile Management](#). Microsoft Windows NT 4.0 pre-dates AD.
- Samba 4 or earlier.

Authentication services

Other authentication services can co-exist with AD within a domain but are not supported by Profile Management. The reason is that, like the Profile Management Service, they can interact with winlogon.exe and cause problems with the user logon process. For example, the authentication service from Novell allows users to access Novell resources, such as printers and file shares, but is not supported.

File services

Third-party file services can be used for the user store and folder redirection (if supported by the Windows operating system being used). File servers must be of the type Server Message Block (SMB) or Common Internet File System (CIFS) and must support the NTFS file system. For these reasons, the following are supported:

- Windows Server 2003 or later
- Samba 3

Important: Because it requires authentication against the Novell directory, the Novell file service is not supported.

FAQs about profiles on multiple platforms and Profile Management migration

August 6, 2024

This section contains questions and answers about using profiles in environments with multiple Windows operating systems, or multiple versions or bitnesses of a single operating system.

How can I be certain of avoiding compatibility issues with my profiles?

Balance the need to support heterogeneous environments with the need for personalization settings to track users and their devices. Typically, the balance between these two needs can only be determined by administrators and IT departments. You manage the different systems by adjusting the user profiles as follows. When profiles roam, any issues must be handled properly or, if necessary, settings must be ignored completely and not tracked at all. This is the basis of many third-party software solutions.

To minimize troubleshooting, try to roam profiles across the same device setup (installed applications, OS version, and so on). In many scenarios in the modern world however, that is not easily achieved, which makes for an imperfect user experience. For example, a user does not need to replicate their Favorites or My Documents just because they use multiple operating systems. Administrators can enhance the user experience in this case by using Folder Redirection. The use of this Microsoft feature is also encouraged in other scenarios.

Can I share profiles across different systems?

Citrix recommends having one base profile for each platform. This is not necessarily the same as one profile per operating system. For more information on this recommendation, see [Plan for multiple platforms](#). This minimizes the number of settings that might not work together or that do not apply to any given OS. For example, desktop power settings are not applicable in a server scenario or one involving Remote Desktop Services (formerly Terminal Services).

As you try to simplify and reduce the number of profiles and they are used on more than one OS, there is greater risk of conflicting settings. This is further compounded when the systems are not the same. For example, Microsoft Office add-ins might not exist on every device. Fortunately, settings such as this one that are not applicable on a given device are often ignored. Support issues arise when they are not ignored. Microsoft Excel fails to start if an add-in is not present.

How does Profile Management enable settings across multiple versions or platforms?

Citrix provides the ability to roam common settings across multiple base profiles. Citrix enables roaming of settings such as Microsoft Office, Internet Explorer, and wallpaper. The ability to support these types of scenarios is limited by the degree to which applications support the roaming of settings between platforms. The links in the next question cover Microsoft's position and best practices.

How does Microsoft support roaming profiles across platforms and versions?

For relevant information, see [Deploying Roaming User Profiles](#).

For Office 2007 toolbar settings, see [Customize the Quick Access Toolbar](#).

Where the standard Microsoft Windows profile solutions do not fully address technical, custom, or business requirements, Profile Management represents a viable solution.

Is sharing a profile between x86 and x64 platforms possible?

Sharing one profile between Windows x86 and x64 might generally work, but some issues are possible.

There are several reasons. For example, one reason is that per-use file associations are stored in `HKEY_CURRENT_USER\SOFTWARE\Classes`. If a non-administrator sets Firefox as their default browser, the following is stored on a 32-bit system:

```
HKEY_CURRENT_USER\SOFTWARE\Classes\FirefoxHTML\shell\open\command -> "C:\Program Files\Mozilla Firefox\firefox.exe"-requestPending -osint -url "%1"
```

If a profile containing this path is used on Windows x64, the OS looks for a 64-bit version of Firefox, but this does not exist. Instead, a 32-bit version is probably installed at `C:\Program Files (x86)\Mozilla Firefox`. This results in the browser not starting.

The reverse is also true. A path is set on an x64 platform but is used on an x86 one.

I want to test how one profile behaves across multiple platforms. Where do I start?

Testing and validating are key to experimenting with the use of one profile on more than one platform. The recommended approach is to have one profile per platform. If you want to explore how a single profile behaves across multiple platforms, the following information might be helpful.

Start by identifying what might cause issues by answering the next question. Use the remaining questions in this topic for ideas for tackling and tracking the issues.

Items that work across platforms:

- My Documents and Favorites
- Applications that store their configuration information (with defaults) completely within the profile

Items that might not work:

- Applications that store hard-coded data, path data, and so on
- Settings specific to x64 or x86 platforms
- Installations of applications that are not identical, such as Excel Add-ins that are not present on all systems. These installations might cause all types of error conditions that vary by application

Can I assign profiles based on the computer a user logs on to?

Yes. Profile Management can apply a profile based on the local desktop, Citrix virtual apps, or Citrix virtual desktops, or any combination of these.

With the correct Profile Management setting enabled, a Remote Desktop Services (formerly Terminal Services) profile is used only when a user has a Terminal Server or Citrix virtual app session. This setting overrides any existing profile (except for a Citrix user profile) when the user logs on through a Remote Desktop Services session.

On Windows 7, you can use a GPO computer setting to assign a profile based on the computer a user logs on to. Again, because this is based on GP, the profile assignment depends on the OU to which the GPO is applied.

Why are profile assignments based on computer desirable?

It is useful to assign a profile to the computer a user logs on to if a distinct user experience is desired. For example, administrators might decide that profiles used with Remote Desktop Services (formerly Terminal Server) sessions are kept separate from profiles used with desktops.

Does Profile Management migrate Windows user profiles to Citrix user profiles?

You can configure Profile Management to automatically migrate existing roaming and local profiles when users log on. You can also use a template profile or the default Windows profile as the basis for new Citrix user profiles.

For information about planning and setting up your Profile Management migration, see [Migrate or create profiles](#). For details of how the software migrates Windows user profiles to Citrix user profiles, see [Logon diagram](#).

Which profiles can be migrated to Citrix user profiles?

Profile Management can migrate Windows local profiles and Windows roaming profiles. Mandatory profiles (.man files) are ignored by Profile Management but they can be used as templates for Citrix user profiles. To ensure Profile Management works correctly, deactivate the assignment of mandatory profiles to all users.

To use your existing Windows mandatory profile as a template, see [Specify a template or mandatory profile](#).

How do I use a template profile?

Profile Management allows you to specify a template profile that is used as the basis for the creation of new Citrix user profiles. Typically, a user who is assigned a profile for the first time receives the default user profile of the Windows device they log on to. This might be acceptable, but it means any variation in different devices' default user profiles results in differences in the base profile created for the user. Therefore, you can regard the template profile feature as a global default user profile.

If you want to prevent users making any change to their profile data, you can also identify a template profile as a Citrix mandatory profile.

For more information, see [Specify a template or mandatory profile](#).

Install and set up

August 6, 2024

This article provides the general workflow for installing Profile Management using its installer. It also provides best practices for setting up Profile Management.

The general workflow for installing Profile Management is as follows:

1. [Download the installation package](#)
2. [Install Profile Management](#)

Refer to the following best practices when setting up Profile Management:

- [Test Profile Management with a local GPO](#)
- [Create the user store](#)

Download the installation package

August 6, 2024

Before you start, make sure that you have a valid Citrix account.

Follow these steps to complete the download:

1. Access the [Citrix Virtual Apps and Desktops download page](#).
2. Locate and expand the version that you want to download (for example, 2206), and then click **Sign in to access restricted downloads**.
3. Sign in with your Citrix account credentials.
4. Select **Citrix Virtual Apps and Desktops 7 <Version_Number> > Product Software > Citrix Virtual Apps and Desktops 7 <Version_Number>, All Editions**.
5. Expand the **Components that are on the product ISO but also packaged separately** node, and then click **Download File** in the **Profile Management** subnode.
6. In the **Download Agreement** dialog box that appears, accept the agreement to start the download.

After the download completes, the `ProfileMgmt_<version_number>.zip` file (for example, `ProfileMgmt_2206.zip`) appears in the Downloads folder.

Files included in the download

Unzip the downloaded package. See the following table for files included in the package.

File Names	Description	location
x86.msi	Installer for 32-bit systems	
x64.msi	Installer for 64-bit systems	
CitrixBase.adml and CitrixBase.admx	ADMX template files for Profile Management policy hierarchy	\Group Policy Templates\CitrixBase
ctxprofile.adml and ctxprofile.admx	ADMX template files for Profile Management policy settings	\Group Policy Templates\<language> (Example: \Group Policy Templates\en)

Install Profile Management

August 6, 2024

Profile Management is an optional component of the VDA installer. You can install it along with the VDA or separately. This article provides guidance on how to install Profile Management using its own installer.

For more information about installing Profile Management along with VDAs, see [Install VDAs](#) in the Citrix Virtual Apps and Desktops document.

Overview

You must install Profile Management on each computer whose user profiles you want to manage. Typically, you run its MSI installer on computers using a distribution tool, an imaging solution, or a streaming technology. You can also install it directly on any computer. Unattended installations are supported.

The general installation procedure is as follows:

1. Run the MSI installer.
2. To configure Profile Management using Group Policy, add ADMX template files to Group Policy.

Note:

We recommend installing the same version of Profile Management on all user computers. Also, add the same version of ADMX template files to Group Policy. This approach prevents corruption of profile data that might occur when different user store structures (from different versions) exist.

Run the MSI installer

This procedure installs Profile Management on a single computer:

1. Log on to the computer as an administrator.
2. Run the MSI installer in the root folder of the [installation package](#). The installation wizard appears.
3. Follow the onscreen instructions to complete the installation.
4. Restart the computer.

In addition to DLLs and other files, the installer creates these files in the installation location (by default, C:\Program Files\Citrix\User Profile Manager).

File Name	Description
UPMPolicyDefaults_all.ini	Profile Management .ini file
UserProfileManager.exe	Windows service carrying out functions on computers managed by Profile Management

Run the MSI installer from the command line

Running the MSI installer from the command line lets you complete the installation without user interaction.

The command line installation also provides the following installation options:

- Suppress the restart using the `/norestart` option.
Depending on the operating system, Profile Management might not function until the computer has restarted. For example, you do not need to restart Windows 7 workstations.
- Specify `INSTALLDIR` if needed.
- Set `INSTALLPOLICYINIFILES` to `no` to prevent the installation of the Profile Management .ini file.

If you have used the .ini file with a previous version and want to use the previous settings in this version, after installation, transfer each setting manually to the equivalent Profile Management policy in the Group Policy Editor.

- Use the `OVERWRITEINIFILES=yes` option for upgrade. For more information, see [Upgrade Profile Management](#).

The following example installs Profile Management without displaying a user interface and a restart. If UAC is enabled, run the `msiexec` command with elevated privileges. For example, from an elevated command prompt.

```
pre codeblock msiexec /i <path to the MSI file> /quiet [/norestart  
] [INSTALLDIR=<installation directory>] [OVERWRITEINIFILES=yes] [  
INSTALLPOLICYINIFILES=no]
```

Uninstall Profile Management

This procedure uninstalls Profile Management from a single computer. Before you start, make sure that you're the computer administrator.

1. To avoid data loss, make sure that all users are logged off.
2. From the list of installed programs in Programs and Features, select **Profile Management** and click **Uninstall**.
3. Click **Yes**.
4. Restart the computer.

You can also uninstall Profile Management in unattended mode.

Add ADMX template files to Group Policy

Depending on how you configure Profile Management using Group Policy, add ADMX template files to *domain controllers* or *computers*:

- To centrally configure Profile Management for computers in an OU, add the ADMX template files to all domain controllers.
- To configure Profile Management individually for each computer, add the ADMX template files to the computer.

Copy the following files from the installation package and paste them to the locations on the domain controllers or computers. See the following table for detailed instructions.

File Names	From (installation package)	To (domain controller or computer)
CitrixBase.adml	\Group Policy Templates\CitrixBase	C:\Windows\ PolicyDefinitions\ <language> (Example: C:\Windows\ PolicyDefinitions\en- US)
CitrixBase.admx	\Group Policy Templates\CitrixBase	C:\Windows\ PolicyDefinitions
ctxprofile.adml	\Group Policy Templates\ <language> (Example: \Group Policy Templates\en)	C:\Windows\ PolicyDefinitions\ <language> (Example: C:\Windows\ PolicyDefinitions\en- US)
ctxprofile.admx	\Group Policy Templates\ <language> (Example: \Group Policy Templates\en)	C:\Windows\ PolicyDefinitions

For more information about ADMX template files, see [this Microsoft article](#).

Configure Profile Management policies with GPOs

After you add ADMX files to domain controllers, follow these steps to view and configure Profile Management policies:

1. On a domain controller, open **Active Directory Users and Computers**. Identify OUs containing the computers where Profile Management is installed.
2. Open **Group Policy Management**, right-click an OU, select **Create a GPO in this domain, and link it here**, and then create a GPO.

Note:

If you apply security filtering to the GPO, do so using either the Authenticated Users group or a computer group. Don't use a security group that contains only individual users.

3. From **Group Policy Objects**, right-click the newly created GPO, and then select **Edit**. The Group Policy Management Editor window appears.
4. Select **Computer Configuration > Administrative Templates...> Citrix Components > Profile Management**. You can see all Profile Management policies.
5. Configure Profile Management as needed.

Test Profile Management with a local GPO

August 6, 2024

We recommend you set up a test environment before deploying Profile Management in a production environment. A fully supported and easier means of transferring settings to the domain Group Policy Objects (GPOs) is based on a local installation on a machine.

The general workflow is as follows:

1. Install Profile Management on a machine.
2. Based on your answers to questions listed in [Decide a configuration](#), configure Profile Management policies with a local GPO.
3. [Enable Profile Management](#).
4. Test logon and logoff behaviors.
5. Adjust the local GPO settings until you receive satisfactory results.

Overview

You can test Profile Management safely using a local GPO if the machine is a member of a production OU. Local GPO policies take effect when OU and domain ones are not available. When using a local GPO, make sure no Profile Management GPOs are used elsewhere (for example, in the domain or sites).

If you can't configure group policies using domain GPOs, you can use local GPOs as a long-term solution. However, this way introduces complexities into the environment, such as:

- Each machine must have the Profile Management ADMX files installed.
- Domain users possibly can't maintain settings when accessing multiple machines.

Important:

We do not recommend using local GPOs as a long-term, enterprise solution.

Test the user experience

When implementing a profile solution, you must minimize the user experience differences when users access resources from various machines.

Users' registry and files might vary depending on the physical machine, profile configuration, and operating system. Thus, you must configure Profile Management to address the differences between system installations on machines where the users roam.

To do so, check user access to resources in ways that mimic your production environment. These resources might include:

- A machine with locally installed applications
- A virtual desktop including streamed or locally installed applications
- A virtual app, either published on or streamed from a virtual apps server
- A Terminal Services client

Test operating system variations

Users might access applications from different operating systems. The variation between them might create conflicting settings within a single user profile.

For more information, see [Profile versions](#).

Create the user store

August 6, 2024

This article helps you create the user store in a way that best suits your organization. In addition to reviewing the information here, be sure to configure the path to the user store as efficiently as possible. For example, configure the path by the sensible use of variables. For advice and examples on that subject, see [Specify the path to the user store](#).

The user store is the central, network location for storing Citrix user profiles.

Any Server Message Block (SMB) or Common Internet File System (CIFS) file share can be used for the user store. The best practice is to ensure that:

- The share is accessible to the accounts used with Citrix user profiles.
- The share is large enough to store profile data.
- The share is robust in case of disk or network failure.

This diagram illustrates an example user store in relation to storage for redirected folder items, the cross-platform settings store (on a separate file server), and Windows 11 virtual desktops (published with Citrix Virtual Desktops) running Microsoft Office. User devices that access the virtual desktops are also shown for reference.

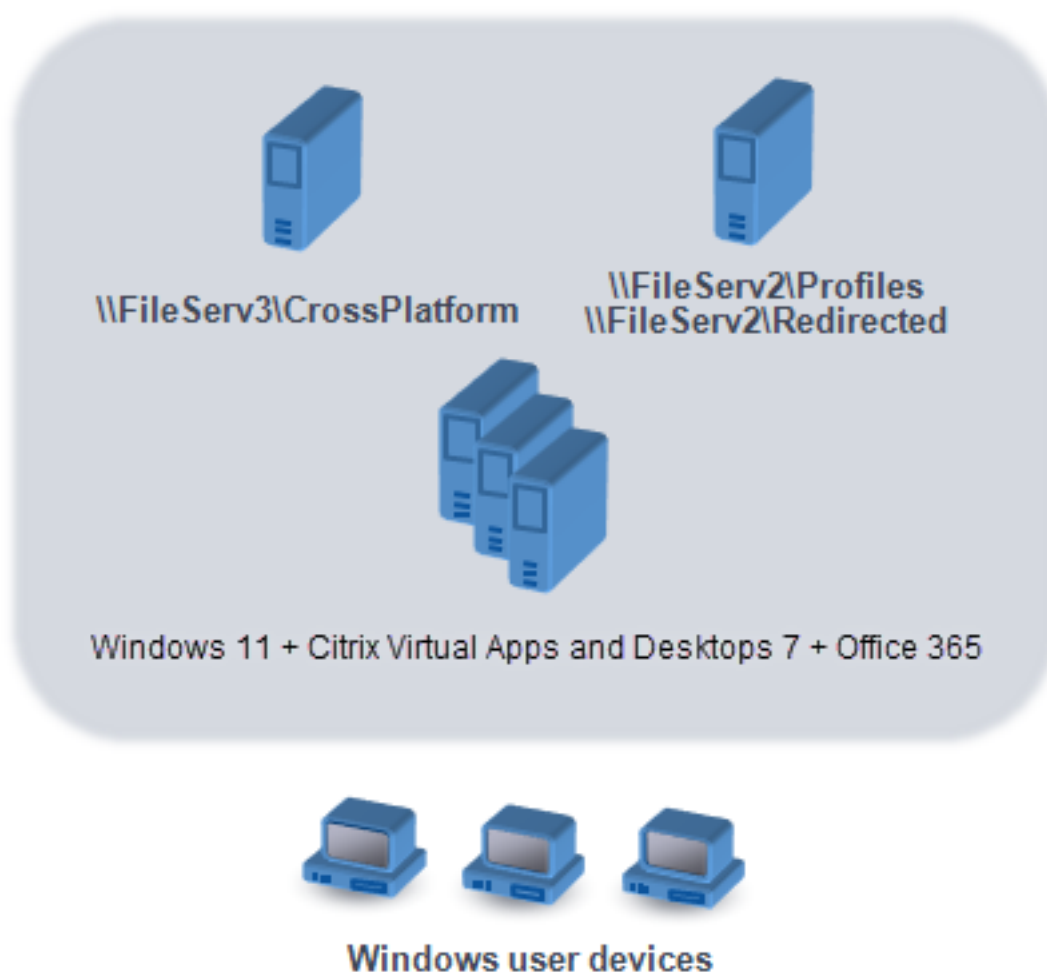

Recommendations on creating secure user stores are available in the article called [Create a file share for roaming user profiles](#) on the Microsoft TechNet website. These minimum recommendations ensure a high level of security for basic operation. Also, when configuring access to the user store, include the Administrators group, which is required to modify or remove a Citrix user profile.

If your deployment includes multiple platforms, review the information on Version 1 and Version 2 profile types in [Plan for multiple platforms](#). As for the structure of the user store, see [Profile Management architecture](#).

Note: If an application modifies the access control list (ACL) of a file in the user's profile, Profile Management does not replicate those changes in the user store. This behavior is consistent with Windows roaming profiles.

Watch this video to [learn more:](#)



Upgrade and migrate

August 6, 2024

This section contains procedures for upgrading Profile Management software and information about transitioning your existing Windows user profiles to Citrix user profiles. For example, you can easily upgrade from Version 3.x to Version 5.x using the procedures.

Before upgrading, understand which Profile Management features and settings are available in the release you are upgrading from and to. To review this information, see [Profile Management policies](#). To facilitate upgrades from .ini files to Group Policy, that topic also maps the settings in the .ini file to the settings in the .adm and .admx files.

Do not configure Profile Management (either in Group Policy or with the .ini file) while upgrading. Separate these two tasks by upgrading your deployment first and then configuring settings as required, ideally by answering the questions in [Decide on a configuration](#).

Tip: You can hotfix your deployment of Profile Management 2.1.1 or later by upgrading to the latest version. After upgrading, you can enable any later feature as needed.

Mixed Deployments

For deployments in which different versions of Profile Management coexist, do the following:

- Minimize the time that a mixed deployment exists.
- Add the latest version's .adm or .admx file to each Group Policy Object on all domain controllers. Ensure all new features are disabled and allowing time for the new policies to propagate.
- Upgrade all computers to the latest version of Profile Management before enabling any policy.

Mixed deployments that contain Versions 5.x and 3.2 are supported. However, treat such deployments as a temporary state that exists during migration from the earlier version to the later one.

Important: Deployments that contain Version 5.x with Version 2.1.1 or any earlier version, including Citrix Technical Preview or beta releases, are unsupported. However, if you cannot upgrade, and those versions must coexist in your deployment, you might find the rest of this topic helpful.

Mixed Deployments Involving Profile Management 2.1.1 or Earlier

The rest of this topic contains information on the coexistence of Profile Management 2.1.1 or earlier, and Profile Management 3.x, or 5.x. It tells you how to migrate from one version to the other. In this topic, the terms Version 2 and Version 5 are used as shorthand for these versions.

Isolate each version in a separate OU and maintain separate user stores for the computers running each version. Alternatively, if a single user store serves computers running both versions, ensure that all Version 5 settings are disabled until all the computers have been upgraded to Version 5. After you enable any Version 4 setting in a “mixed” user store, users can still log on to a computer that runs Version 2. But they receive a temporary Windows user profile (not their network, Citrix user profile) and the changes they make to that profile are not saved. You must consider mixed deployments to be temporary, and minimize the time they exist before completing the upgrade.

Using separate OUs and user stores can be inconvenient. To avoid these constraints, you can use one of the following two strategies. You configure each group in the appropriate version of Profile Management using the Processed groups setting. Strategy 2 is more work than Strategy 1. With the former, you keep updating the Version 5 processed user groups. And you maintain two sets of applications and desktops (but you can automate by exporting application definitions from Citrix virtual apps). The advantage is that you can take your time over the migration.

Note: As an alternative to the following strategies, with Windows Server 2008 Active Directory you can use WMI filtering to apply a GPO to a subset of computers in an OU, and determine which version of

Profile Management is installed. Thus, you can automatically adjust which policy is applied, to match the version.

Strategy 1: One-off Migration

This scenario assumes that some downtime is acceptable. All computers are migrated at the same time.

The migration strategy is:

1. Replace the Version 2 ADM file with the Version 5 file. The latter is compatible with the earlier version, so Version 2 computers continue to operate normally.
2. Ensure all Version 5 settings are disabled. Do not rely on the default **Not enabled**.
3. Start upgrading all the computers from Version 2 to Version 5. Fit this in with your normal maintenance and update schedules. With one exception, Version 5 acts as Version 2 until you enable any Version 5 setting. The exception is as follows. It is rare but more likely to occur if this upgrade step is staggered over a long time. If a user accesses their Citrix user profile from multiple servers, multiple Version 4 sessions are created. For example, they first use a workstation to access a virtual desktop on one server and then a laptop to access a published application on another. Profile Management must use the pending area for the second, laptop session. At this point, the entire OU is treated as a Version 5 deployment (albeit one without any configured Version 5 features). And PmCompatibility.ini is updated to reflect this change.
4. Optionally, set your Version 5 processed users group to include only the members of a small pilot group. Wait for the AD Group Policy changes to propagate throughout the network (for example, over a weekend). You do not need to prevent access for any other users while this change is happening. Back up the profiles of the pilot group. Then let the pilot group test Profile Management.
5. When you are happy with the pilot group results, ensure that you have backed up the other users' profiles.
6. Use the next scheduled maintenance period to add the remaining users to the Version 5 processed users group. Allow sufficient time for the AD Group Policy changes to propagate, and let the remaining users log on.

Strategy 2: Phased Migration

This scenario assumes that you cannot move all your machines or your users to the new version in one go, so you select subsets of users that you migrate in batches. It suits deployments with several data centers or geographically distributed users.

The migration strategy is:

1. Replace the Version 2 ADM file with the Version 5 file. The latter is compatible with the earlier version, so Version 2 computers continue to operate normally.
2. Ensure all Version 5 settings are disabled. Do not rely on the default Not enabled.
3. Upgrade a few computers (the first batch) to Version 5. Alternatively, install Version 5 on new computers. By default, your Version 5-processed users group contains an empty group, so no user is processed as a Version 5 user. Be aware of the exception described in Strategy 1, which might also apply when you upgrade computers in a phased migration.
4. Publish new applications (using Citrix Virtual Apps) or virtual desktops (using Citrix Virtual Apps or Citrix Virtual Desktops) from your Version 5 computers. These applications and desktops are identical to the ones previously published from your Version 2 computers, except for their names. These names identify them as for use by Version 5 users.
5. The selected users in this batch log on to the applications or desktops (for example, using Web Interface). They choose the new applications. (Use Web Interface to enforce this step, based on user name or group membership). As a result, their sessions run on the Version 4 computers but they are processed with Version 2 settings.
6. Ensure that you have backed up all users' profiles.
7. Move the users out of the Version 2 processed users group and into the Version 4 group. Wait for the AD Group Policy changes to propagate to the Version 5 computers. Next time they log on, the users' sessions are processed with Version 5 settings.
8. Upgrade the next batch of computers and migrate the next batch of users, as described earlier.

Upgrade Profile Management

August 6, 2024

This article provides guidance on upgrading your Profile Management deployment by using Active Directory.

Important: It is important that you follow the order of the steps in this upgrade process. Upgrade the software on all computers only after adding the new .adm or .admx file to Group Policy. If you upgrade beforehand, log files might be stored in two locations. One contains log files for the old version and the other contains the files for the new version. This consideration particularly affects Citrix virtual desktops deployments.

It is also important to upgrade during a scheduled maintenance period. Or upgrade at a time when Active Directory replication allows the changes to propagate through your deployment. Typically, upgrade can take up to 24 hours.

The upgrade process involves:

1. Creating a Group Policy Object (GPO) and adding the new .adm or .admx file to the new GPO

- or -

Upgrading an existing .adm or .admx file as described later in this article.

2. Upgrading the .msi file on all computers as described later in this article.
3. Applying the GPO.

To upgrade an existing .adm file

If any earlier version of the Profile Management .adm file exists in Group Policy, you can upgrade it by using the following procedure. All policy settings in the earlier version are preserved when you upgrade.

1. On the domain controller, do one of the following:
 - Import the existing .adm file. The file resides in the GPO_Templates folder in the download package.
 - Copy the .admx file from the GPO_Templates folder in the download package to the C:\Windows\PolicyDefinitions folder and copy the .adml file to the C:\Windows\PolicyDefinitions\<localized folder>. For example, on English operating systems, <localized folder> is en-US.
2. On the computer you use to configure Profile Management, open the Group Policy Object Editor.
3. In the Group Policy Object Editor, right-click **Administrative Templates** and select **Add/Remove Templates**.
4. Select the existing version of the Profile Management .adm file (for example, ctxprofile5.4.1), click **Remove** and then **Close**. The Administrative Templates\Citrix folder is deleted.
5. Right-click **Administrative Templates** and select **Add/Remove Templates** again.
6. Click **Add**, browse to the location of the new version of the .adm or .admx file (for example, ctx-profile5.5.0), select it, and click **Close**. The new file is imported but the old settings are retained.

To upgrade the .msi file

We recommend that you install the same version of Profile Management on all user devices and that you add the .adm or .admx file of that same version to each Group Policy Object on all domain controllers. Doing so prevents corruption of profile data, which might result when different user store structures (from different versions) exist.

We recommend that you upgrade all computers to the latest version of Profile Management before enabling any new setting. To check whether a setting is new in the version you are using, see [Profile Management policies](#).

1. Ensure that all users are logged off from the computers you want to upgrade.

2. Install the new version of Profile Management over the existing version by running the .msi file on each computer. For more information, see [Install and set up](#).

To upgrade the .ini file

You edit the .ini file in an earlier version of Profile Management and upgrade to a newer version. The software can detect that the file was edited and, by default, does not overwrite it. To preserve your .ini file settings, and use the new settings in the newer version, you must do one of the following:

- Manually add the new settings from the .ini file of the newer version to your existing, edited .ini file.
- Save a copy of the existing, edited version's .ini file. Use the OVERWRITEINIFILES=yes command-line option to force an overwrite of the file during the upgrade. Add your saved settings to the upgraded .ini file. For example:

```
msiexec /i <path to the MSI file\> /quiet [INSTALLDIR=<installation directory>] [OVERWRITEINIFILES=yes] [INSTALLPOLICYINIFILES=no]
```

Note

To configure Profile Management policy through HDX, you must:

- upgrade your Delivery Controllers. The reason is that HDX reads the Profile Management policy settings from the UserProfileManager_PowerShellSnapIn.msi file present in the XenApp and XenDesktop layout image-full\x64\Citrix Desktop Delivery Controller.
- upgrade your VDAs to get the latest version of Profile Management.

More Resources

- [Profile Management policies](#)
- [Install and set up](#)

Migrate user profiles

August 6, 2024

This article guides you through two migration workflows:

- Migration to the Citrix container-based profile solution
- Migration to Windows roaming profile solution

For more information about migration strategies, see [Upgrade and migrate](#).

Migrate to the Citrix container-based profile solution

You can use the migration tool in the Profile Management installation package to migrate user profiles from the following profile solutions to the Citrix container-based profile solution:

- Windows local profile solution
- Citrix file-based profile solution
- FSLogix Profile Container

Migration workflow

To migrate your current profile solution to the Citrix container-based profile solution, follow these steps:

1. Set up the Citrix user store on a storage server and configure its Windows Access Control Lists (ACLs).

For more information, see [Create the user store](#).

2. Migrate user profiles using the migration tool delivered with Profile Management.

For more information, see [Example: Migrate user profiles for FSLogix Profile Container](#)

3. Install Profile Management on your machines.

For more information, see [Install and set up](#).

4. Set up the container-based profile solution by configuring specific Profile Management policies. The essential workflow is as follows:

- a) [Enable Profile Management](#)
- b) Specify the path to the user store ([Path to user store](#))
- c) Enable profile containers for the entire user profile [Profile container](#)

For more information about advanced settings for profile containers, see [Citrix Profile Management profile container](#).

5. (For FSLogix Profile Container) Disable FSLogix Profile Container on your machines. Otherwise, the Citrix container-based solution can't work properly. Detailed steps are as follows:

- a) In **Registry Editor**, go to `HKEY_LOCAL_MACHINE\SOFTWARE\FSLogix\Profiles`.
- b) Set **Enabled** to **0**.

Example: Migrate user profiles for FSLogix Profile Container

This section details how to migrate user profiles from VHDX-based FSLogix Profile Container to the Citrix container-based profile solution.

Before you begin, make sure that you meet the following requirements:

- Have set up the Citrix user store on a storage server and configured its Windows Access Control Lists (ACL).
- Have the VHDX location of the FSLogix Profile Container.
- Have the credentials of a domain administrator.

Detailed steps are as follows:

1. Log on to a machine using the domain administrator account.
2. Run **Windows PowerShell ISE** as an administrator.
3. In the PowerShell console, access the **\tool** folder in the Profile Management installation package, and then run **CPM_ProfileContainer_Migration_Tool.ps1**.
4. When prompted, choose migration type **3**, which represents migrating user profiles from FSLogix Profile Container (VHDX) to the Citrix container-based profile solution.
5. Enter users and groups that you want to migrate, separated by commas. Example: `<DOMAIN NAME>\<USER_NAME1> , <DOMAIN NAME>\<GROUP_NAME1>`
6. Enter the VHDX location of the FSLogix Profile Container.
7. Enter the path to the Citrix VHDX store.

Note:

- You can use either the Citrix user store or a different network storage as the Citrix VHDX store.
- Only `%USERNAME%` is supported among all variables.

8. Specify the Windows OS version of your machines by entering its short name. To get short names of Windows OS versions, see [Profile Management policies](#).

Note:

Only user profiles with the specified OS type are migrated.

Upon completion, the migration results appear on the screen.

Migrate to Windows roaming profiles

You can migrate Citrix user profiles to Windows roaming profiles at any time. Move profile data to a network location where the roaming profiles are stored. After migration, Profile Management takes no part in processing user logons or application settings.

1. Make sure that all users are logged off.
2. Remove the Profile Management Service from all computers that the software manages.
3. In the user store, move the contents of \UPM_Profile to your roaming profile location. You do not have to move the contents of the cross-platform settings store.
4. (For Version 1 profiles only) Remove the _upm_var suffix from all subfolders of \UPM_Profile.
Note: You might find that scripting simplifies this step.

Configure

August 6, 2024

This topic introduces how to configure Profile Management policies to meet your deployment requirements.

Configuration precedence

August 6, 2024

You can configure Profile Management using Group Policies and the .ini file. Configuration settings are applied as follows:

1. Settings defined by Group Policies take precedence. The .ini file is queried only if a policy setting is set to **Not Configured**.
Note: If you apply a Group Policy Object selectively to sites and domains within an Organizational Unit, a further precedence applies. See [Group Policy: Filtering and Permission](#). Domain and OU Group Policies take precedence over local policies.
2. Where a setting is not defined by a policy, Profile Management tries to read the setting from the .ini file.
3. If a setting is not configured by a group policy or in the .ini file, the default setting is used.

There might be situations where you want to configure the same setting differently in Group Policy and the .ini file. For example when you want to activate default logging with a Group Policy setting but activate verbose logging using the .ini file on a computer that you use for troubleshooting.

About the Profile Management .ini file

Default configuration

Profile Management comes with a default configuration stored in an .ini file. This file must be in the installation folder so that the Profile Management Service can recognize it. The default configuration is suitable for most environments. It processes the profiles of all users in all groups.

If you have a non-English deployment of Profile Management running on Windows XP or Windows Server 2003, you must create an appropriate language version of the .ini file using UPMPolicyDefaults_all.ini. Rename a copy of this file to reflect your language (for example, UPMPolicyDefaults_all_es.ini for Spanish) and localize the folder names. Use these file names:

- For French operating systems, UPMPolicyDefaults_all_fr.ini
- For German operating systems, UPMPolicyDefaults_all_de.ini
- For Spanish operating systems, UPMPolicyDefaults_all_es.ini
- For Japanese operating systems, UPMPolicyDefaults_all_ja.ini
- For Simplified Chinese operating systems, UPMPolicyDefaults_all_zh-CN.ini

Modify the .ini file

If you add entries to the .ini file, ensure that the variables and values have the correct format.

Flags (on/off indicators) must be of this form:

```
1 <variable>=<value>
```

A value of 1 enables a setting and any other value or no value disables it. For example, the following entry enables the `ServiceActive` setting:

```
1 ServiceActive=1
```

Any of the following entries disable the setting:

```
1 ServiceActive=0N
2 ServiceActive=OFF
3 ServiceActive=TRUE
4 ServiceActive=FALSE
5 ServiceActive=
```

List entries must be of this form:

```
1 <value>=
```

The following entry specifies Microsoft Office files to be synchronized:

```
1 [SyncFileList]
2 AppData\Local\Microsoft\Office\*.OfficeUI
```

Changes to Group Policy settings take effect when a manual or automatic policy refresh occurs on the target computers. Changes to the .ini file take effect when you issue the command **gpupdate /force**, which is recommended. Or the changes take effect when you restart the Profile Management Service on the target computers.

Enable Profile Management

August 6, 2024

By default, to facilitate deployment, Profile Management does not process logons or logoffs. Enable Profile Management only after carrying out all other setup tasks and testing how Citrix user profiles perform in your environment.

To enable Profile Management using Group Policy, follow these steps:

1. Open the **Group Policy Management Editor**.
2. Under **Computer Configuration > Policies > Administrative Templates: Policy definitions (ADMX files) > Citrix Components > Profile Management**, double-click the **Enable Profile management** policy.
3. Select **Enabled**.

You can also enable Profile Management using the UPMPolicyDefaults_all.ini file. To do so, follow these steps:

1. On the machine where Profile Management is installed, navigate to `C:\Program Files\Citrix\User Profile Manager\UPMPolicyDefaults.ini`.
2. Open UPMPolicyDefaults.ini using Notepad.
3. Edit the configurations to reflect your specifics.

If this setting is not configured in Group Policy, the value from the .ini file is used. If this setting is not configured in Group Policy or in the .ini file, Profile Management does not process Windows user profiles in any way.

You can also choose to enable Profile Management using:

- Citrix Studio. For instructions on enabling Profile Management using Citrix Studio, see Knowledge Center article [CTX222893](#).

- Workspace Environment Management (WEM). For instructions on enabling Profile Management using WEM, see Knowledge Center article [CTX229258](#).

For your changes to take effect, run the `gpupdate /force` command from the command prompt as documented at <https://docs.microsoft.com/en-us/windows-server/administration/windows-commands/gpupdate>.

Watch this video to learn more:



Specify the path to the user store

August 6, 2024

Before specifying the path to the user store, refer to [Profile Management architecture](#) and, if relevant to your deployment, understand the effect of:

- Storing multilingual profiles
 - Combining inclusions and exclusions
1. Under Profile Management, double-click the Path to user store policy.
 2. Select Enabled and enter the path to the directory (the user store) in which the user settings (registry changes and synchronized files) are saved.

The path can be:

- **A relative path.** This path must be relative to the home directory, which is typically configured as the #homeDirectory# attribute for a user in Active Directory (AD).
- **A UNC path.** This path typically specifies a server share or a DFS namespace.
- **Disabled or unconfigured.** In this case, a value of #homeDirectory#Windows is assumed.

The following types of variables can be used for this setting:

- System environment variables enclosed in percent signs (for example, %ProfVer%). System environment variables generally require extra setup. For more information, see [Administer profiles within and across OUs](#).
- Attributes of the AD user object enclosed in hashes (for example, #sAMAccountName#).
- Profile Management variables. For more information, see [Profile Management policies](#).

User environment variables cannot be used, except for %username% and %userdomain%. You can also create custom AD attributes to define organizational variables such as location or users. Attributes are case-sensitive.

Examples:

- \\server\share\#sAMAccountName# stores the user settings to the UNC path \\server\share\JohnSmith (if #sAMAccountName# resolves to JohnSmith for the current user)
- \\server\profiles\$\%USERNAME%.%USERDOMAIN%\!CTX_OSNAME!!CTX_OSBITNESS! might expand to \\server\profiles\$\JohnSmith.Finance\Win8x64

Important: Whichever attributes or variables you use, check that this setting expands to the folder one level higher than the folder containing NTUSER.DAT. For example, if this file is contained in \\server\profiles\$\JohnSmith.Finance\Win8x64\UPM_Profile, set the path to the user store as \\server\profiles\$\JohnSmith.Finance\Win8x64 (not the \UPM_Profile subfolder).

This diagram illustrates the components of a typical path to the user store that incorporates AD attributes, environment variables, and Profile Management variables.

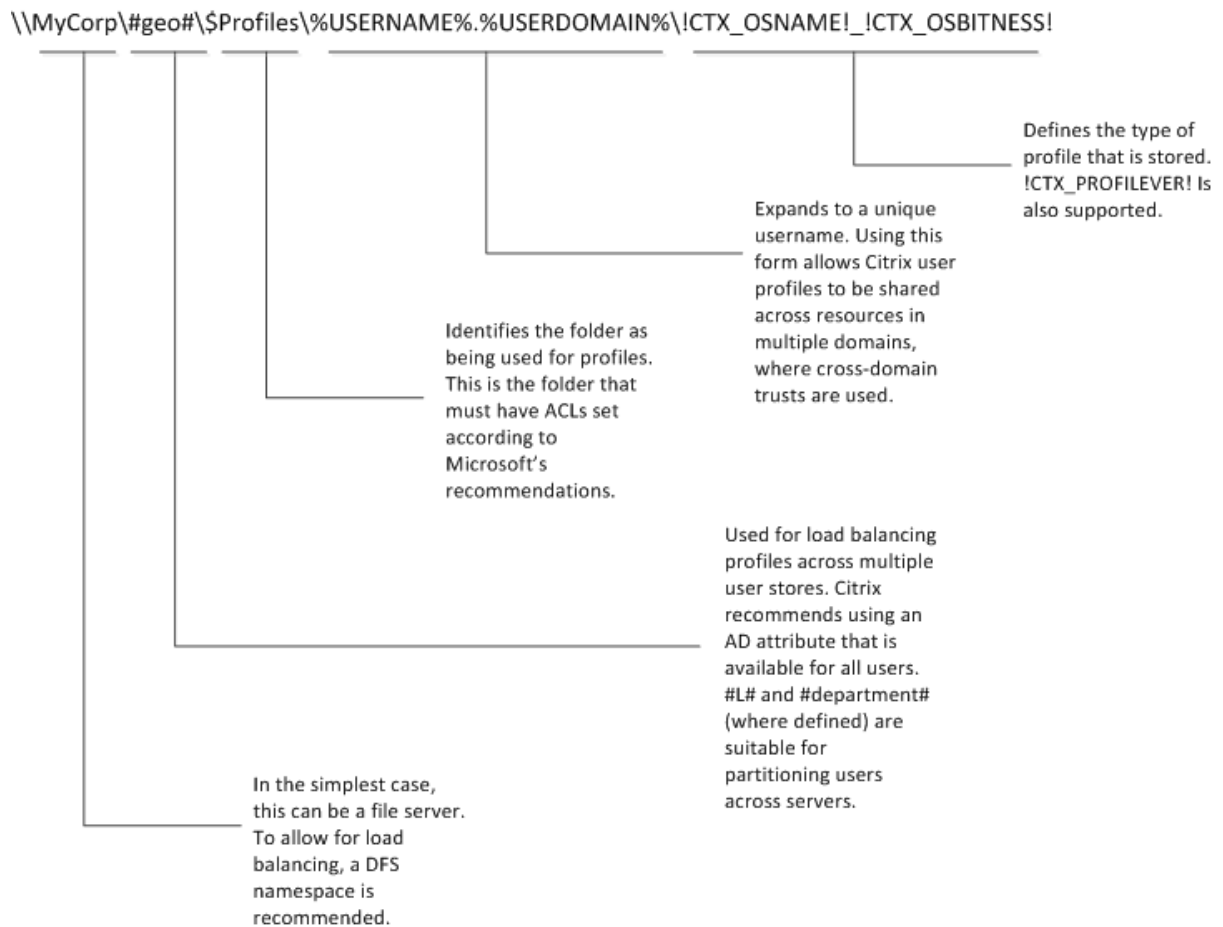

For more information on using variables when specifying the path to the user store, see the following topics:

- [Share Citrix user profiles on multiple file servers](#)
- [Administer profiles within and across OUs](#)
- [High availability and disaster recovery with Profile Management](#)

If Path to user store is disabled, the user settings are saved in the Windows subdirectory of the home directory.

If this setting is not configured here, the setting from the .ini file is used. If this setting is not configured here or in the .ini file, the Windows directory on the home drive is used.

For your changes to take effect, run the `gpupdate /force` command from the command prompt as documented at <https://docs.microsoft.com/en-us/windows-server/administration/windows-commands/gpupdate>.

Include and exclude items

August 6, 2024

This article describes the process that Profile Management uses to include and exclude items from users' profiles. Ensure that you understand this process if you decide to modify the default inclusion or exclusion lists to improve the logon and logoff experience of your users. To help you determine whether this modification is required, see [Which applications are in use](#).

For example, you might include Microsoft Word because it is a highly customizable and frequently used application that must present the same experience to roaming users however it is accessed. Conversely, you might exclude an enterprise application because it is infrequently used by some groups so its profile data does not need to be downloaded at each logon and logoff.

By default, all files and folders in local profiles are synchronized with the user store. You can specify files and folders that you do not want to synchronize by adding them to an exclusion list. If you exclude a folder, you can specify its subfolders that you do want to synchronize by adding them to an inclusion list.

You can include and exclude:

- Files and folders contained inside profiles.
- Registry entries in the HKCU hive that store personalization settings. Entries in the HKLM hive are not processed by default and cannot be configured to do so.

Before including and excluding items

Before tuning the contents of your users' profiles, consider using the set of built-in Windows Performance Monitoring (Perfmon) counters. These provide insights into the behavior of your profiles. Available counters include measurements of the profile size and the time taken to create a Citrix user profile on the local computer.

You might need to decide whether to cache profiles locally (on the computers that run Profile Management). Factors that affect the decision include the Citrix products in your deployment, the available space on the local computers, and the number of users in the deployment.

Files and folders

All included and excluded folder names are language specific. However, folder names in the user store are in a format independent of the operating system language.

You can synchronize files or folders on disks that are treated as local by the operating system. You cannot synchronize files or folders on network mapped drives.

The registry

For existing users, the entire HKCU hive is copied to the user store. For new users, the hive of their Microsoft local, roaming, default, or template profile is copied. Inclusions are added and exclusions are removed from the hive when changes are made to the user store.

If you have a template profile that contains unwanted keys, use a tool such as Profile Nurse from Sepago to eliminate them from the user store.

About exclusions

Exclusions are processed at logoff not logon. They do not delete data from the user store but prevent new data from being written to it.

Other than the default exclusions, typically you do not need to exclude any items when you first roll out Profile Management. Later, as you track application performance and gather feedback from users, you might need to exclude items if settings from multiple applications clash or if a user's NTUSER.DAT file grows large as a result of collecting unneeded settings.

Do not add redirected folders as exclusions.

Important: Citrix recommends excluding the `AppData\LocalLow` folder from synchronization. In the default configuration, the exclusion list already contains `AppData\LocalLow`. Besides, you can also choose to exclude partial content from the `AppData\Local` folder. If you do not exclude `AppData\LocalLow` or `AppData\Local`, a large amount of data can be transferred over the network and users can experience logon delays. The folders are not synchronized by standard Windows roaming profiles.

Inclusion and exclusion rules

The following rules are used when Profile Management includes and excludes files, folders, and registry keys:

1. All items are included by default
2. If the same path is configured as both an inclusion and an exclusion, the inclusion takes precedence
3. An inclusion takes precedence over an exclusion in the same folder
4. An inclusion takes precedence over an exclusion higher up in the folder hierarchy
5. An exclusion takes precedence over an inclusion higher up in the folder hierarchy

These rules result in sensible and intuitive behavior. All items are included by default. From that starting point, you can configure top-level exceptions as exclusions, then configure deeper exceptions to the top-level exceptions as inclusions, and so on.

Default inclusions and exclusions

August 6, 2024

Note:

Default inclusions and exclusions apply only to the file-based profile solution.

This topic describes the default items that Profile Management includes in and excludes from its processing. Depending on the applications in your deployment, extra (non-default) items might be required. To help you determine which extra items you include or exclude, see [Which applications are in use](#)

Important: If you use Group Policy rather than the .ini file (or you are rolling out a Group Policy deployment after a successful test with the .ini file), unlike the installed .ini file, no items are included or excluded by default in the .adm or .admx file. You must add the default items manually to the file. These items are shown in the tables in this topic. Note the following:

- Use [Profile Management policies](#) to map setting names in the .ini file and the .adm or .admx file, and to understand how the Profile Management variables (for example, !ctx_internetcache!) expand
- When pasting inclusions and exclusions from the .ini file, remove the trailing = (equals sign) from each item
- Do not add an initial backslash to inclusions and exclusions

Registry inclusion list

Default Value

Registry exclusion list

Default Value

Software\Microsoft\AppV\Client\Integration=

Software\Microsoft\AppV\Client\Publishing=

Software\Microsoft\Speech_OneCore=

Note: If you are using Microsoft App-V, this exclusion is not correct and different exclusions are required as documented at

[Profile Management and App-V](#).

Folder inclusion list

Default Value

All folders in the profile are included by default.

Folder exclusion list

Folders in this table are excluded from synchronization.

Default Value

!ctx_internetcache!=

!ctx_localappdata!\Google\Chrome\User Data\Default\Cache=

!ctx_localappdata!\Google\Chrome\User Data\Default\Cached Theme Images=

!ctx_localappdata!\Google\Chrome\User Data\Default\JumpListIcons=

!ctx_localappdata!\Google\Chrome\User Data\Default\JumpListIconsOld=

!ctx_localappdata!\GroupPolicy=

!ctx_localappdata!\Microsoft\AppV=

!ctx_localappdata!\Microsoft\Messenger=

!ctx_localappdata!\Microsoft\Office\15.0\Lync\Tracing=

!ctx_localappdata!\Microsoft\OneNote=

!ctx_localappdata!\Microsoft\Outlook=

!ctx_localappdata!\Microsoft\Terminal Server Client=

!ctx_localappdata!\Microsoft\UEV=

!ctx_localappdata!\Microsoft\Windows Live=

!ctx_localappdata!\Microsoft\Windows Live Contacts=

!ctx_localappdata!\Microsoft\Windows\Application Shortcuts=

Default Value

!ctx_localappdata!\Microsoft\Windows\Burn=
!ctx_localappdata!\Microsoft\Windows\CD Burning=
!ctx_localappdata!\Microsoft\Windows\Notifications=
!ctx_localappdata!\Packages=
!ctx_localappdata!\Sun=
!ctx_localappdata!\Windows Live=
!ctx_localsettings!\Temp=
!ctx_roamingappdata!\Microsoft\AppV\Client\Catalog=
!ctx_roamingappdata!\Sun\Java\Deployment\cache=
!ctx_roamingappdata!\Sun\Java\Deployment\log=
!ctx_roamingappdata!\Sun\Java\Deployment\tmp=
\$Recycle.Bin=
AppData\LocalLow=
Tracing=

File inclusion list

Default Value

All files in the profile are included by default.

File exclusion list

Default Value

No files in the profile are excluded by default.

Include and exclude items

August 6, 2024

As a prerequisite, ensure that you understand how inclusions and exclusions work. For more information, see [Include and exclude items](#). For information on the default included and excluded items, see [Default inclusions and exclusions](#).

Use Enter to separate multiple entries when you include and exclude items.

To exclude items

1. Under **Profile Management > Registry**, click the **Exclusion list** policy.
2. Select **Enabled**.
3. Click **Show** and add any registry keys in the **HKCU** hive that you do not want Profile Management to synchronize during logoff. Example: `Software\Policies`.
4. Under **Profile Management > File system**, double-click the **Exclusion list - directories** policy.
5. Select **Enabled**.
6. Click **Show** and add any folders that you do not want Profile Management to synchronize.

Be aware of the following:

- Specify the folders using paths relative to the user profile (`%USERPROFILE%`) and omit initial backslashes from paths.
- Use the variable `%USERPROFILE%` to locate the profile but do not enter the variable itself in this policy.
- As of Profile Management 2112, wildcards in folder names are supported but are not applied recursively.

Examples:

- `Desktop`. Does not synchronize the `Desktop` folder.
- `MyApp\tmp`. Does not synchronize the `%USERPROFILE%\MyApp\tmp` folder.

7. Under **Profile Management > File system**, double-click the **Exclusion list - files** policy.
8. Select **Enabled**.
9. Click **Show** and add any files that you do not want Profile Management to synchronize.

Be aware of the following:

- Specify the file names with paths relative to the user profile (%USERPROFILE%). Do not enter the variable (%USERPROFILE%) in this policy.
- Wildcards in file names are supported and applied recursively. As of Profile Management 7.15, you can use the vertical bar (|) to restrict the policy only to the current folder.
- As of Profile Management 2112, wildcards in folder names are supported but are not applied recursively.

Examples:

- `Desktop\Desktop.ini`. Ignores `Desktop.ini` in the `Desktop` folder.
- `AppData*.tmp`. Ignores all files with the `.tmp` extension in the `AppData` folder and its subfolders.
- `AppData*.tmp|`. Ignores all files with the `.tmp` extension only in the `AppData` folder.
- `Downloads*\a.txt`. Ignores `a.txt` in any immediate subfolder of the `Downloads` folder.

If **Exclusion list** is disabled, no registry keys are excluded. If this setting is not configured here, the value from the .ini file is used. If this setting is not configured here or in the .ini file, no registry keys are excluded.

If **Exclusion list - directories** is disabled, no folders are excluded. If this setting is not configured here, the value from the .ini file is used. If this setting is not configured here or in the .ini file, no folders are excluded.

If **Exclusion list - files** is disabled, no files are excluded. If this setting is not configured here, the value from the .ini file is used. If this setting is not configured here or in the .ini file, no files are excluded.

For your changes to take effect, run the `gpupdate /force` command from the command prompt as documented at <https://docs.microsoft.com/en-us/windows-server/administration/windows-commands/gpupdate>.

To include items

Tip:

You can include specific top-level folders. In a collaborative environment, this step has the advantage of flagging critical folders to other administrators.

1. Under **Profile Management > Registry**, double-click the **Inclusion list** policy.
2. Select **Enabled**.
3. Click **Show** and add any profile-related registry keys in the `HKEY__CURRENT__USER` hive that you want Profile Management to process during logoff. Example: `Software\Adobe`.

4. Under **Profile Management > File system > Synchronization**, double-click the **Directories to synchronize** policy.
5. Select **Enabled**.
6. Click **Show** and add folders that are inside excluded folders but that you want Profile Management to synchronize. Example: `Desktop\exclude\include` ensures that the `include` subfolder is synchronized even if the folder `Desktop\exclude` is not.

Be aware of the following:

- Specify the folders using paths relative to the user profile.
- As of Profile Management 2112, wildcards in folder names are supported but are not applied recursively.

7. Under **Profile Management > File system > Synchronization**, double-click the **Files to synchronize** policy.
8. Select **Enabled**.
9. Click **Show** and add files that are inside excluded folders but that you want Profile Management to synchronize.

Be aware of the following:

- Specify the files with paths relative to the user profile.
- Wildcards in file names are supported and applied recursively. But wildcards cannot be nested. As of Profile Management 7.15, you can use the vertical bar (|) to restrict the policy only to the current folder so that the policy does not apply to the subfolders.
- As of Profile Management 2112, wildcards in folder names are supported but are not applied recursively.

Examples:

- `AppData\Local\Microsoft\Office\Access.qat`. Specifies a file inside a folder that is excluded in the default configuration.
 - `AppData\Local\MyApp*.cfg`. Specifies all files with the `.cfg` extension in the `AppData\Local\MyApp` folder and its subfolders.
 - `Downloads*\a.txt`. Specifies `a.txt` in any immediate subfolder of the `Downloads` folder.
- Profile Management synchronizes each user's entire profile between the system it is installed on and the user store. It is not necessary to include files in the user profile by adding them to this list.

If **Inclusion list** is not configured here, the value from the `.ini` file is used. If this setting is not configured here or in the `.ini` file, the entire `HKEY_CURRENT_USER` hive is processed.

If **Directories to synchronize** is not configured here, the value from the .ini file is used. If this setting is not configured here or in the .ini file, only non-excluded folders in the user profile are synchronized. Disabling this setting has the same effect as enabling it and configuring an empty list.

If **Files to synchronize** is not configured here, the value from the .ini file is used. If this setting is not configured here or in the .ini file, only non-excluded files in the user profile are synchronized. Disabling this setting has the same effect as enabling it and configuring an empty list.

For your changes to take effect, run the `gpupdate /force` command from the command prompt as documented at <https://docs.microsoft.com/en-us/windows-server/administration/windows-commands/gpupdate>.

Use wildcards

August 6, 2024

You can use DOS-style wildcard characters such as the question mark (?) and asterisk (*) in policies that refer to files and folders. Examples include file inclusion and exclusion lists and folder inclusion and exclusion lists. The question mark (?) matches a single character. The asterisk (*) matches zero or more characters.

Starting with Profile Management 7.15, you can use the vertical bar (|) to restrict the policy only to the current folder.

Be aware of the following:

- Wildcards in file names work recursively while wildcards in folder names don't. Ensure that you specify a valid path when using wildcards.
- Policies that support wildcards do not support any other type of variable, such as the use of environment variables or Active Directory attributes. You cannot use wildcards in policies that refer to registry entries.

Examples

The wildcard `<path name>\h*.txt` matches `house.txt`, `h.txt`, and `house.txt.txt`, but does not match `ah.txt`.

The wildcard `<path name>\a?c.txt` matches `abc.txt`, but does not match `ac.txt`.

The wildcard `<path name>\a?c*d.txt` matches `abcd.txt` and `abccd.txt`, but does not match `acd.txt`.

Configuring policies in the profile root folder:

- `*.txt` specifies all files with the extension `.txt` in the root folder and its subfolders.
- `*h.txt` specifies all files that match this wildcard in the root folder and its subfolders.
- `h*.txt` specifies all files that match this wildcard in the root folder and its subfolders.
- `a?c.txt` specifies all files that match this wildcard in the root folder and its subfolders.
- `*.txt|` specifies all files with the extension `.txt` only in the root folder.

Configuring policies in non-profile root folders:

- `AppData*.txt` specifies all files that match this wildcard in the AppData folder and its subfolders.
- `AppData*h.txt` specifies all files that match this wildcard in the AppData folder and its subfolders.

Enable logon exclusion check

August 6, 2024

The **Enable Logon exclusion check** feature controls what Profile Management does if a profile in the user store contains excluded files and folders when a user logs on. By default, the feature is disabled.

Excluded files and folders refer to files and folders that you add to the **Exclusion list - files** and **Exclusion list - directories** policies respectively. When users log off, Profile Management doesn't synchronize excluded files and folders to the user store. However, excluded files and folders might exist in the user store before you add them to exclusion lists. With the **Enable logon exclusion check** policy, you can have Profile Management ignore those files and folders or delete them from the user store when users log on.

To use this feature, follow these steps:

1. Open the Group Policy Management Editor.
2. Under **Computer Configuration > Policies > Administrative Templates: Policy definitions (ADMX files) > Citrix Components > Profile Management > File system**, double-click the **Logon Exclusion Check** policy.
3. Select **Enabled**.
4. Select an option from the drop-down menu. By default, **Delete excluded files or folders** is selected.
5. Click **OK**.

This feature provides the following three options:

- **Delete excluded files or folders.** Deletes the excluded files and folders from the user store when a user logs on.
- **Ignore excluded files or folders.** Ignores the excluded files and folders from the user store when a user logs on.
- **Synchronize excluded files or folders.** Synchronizes the excluded files and folders from the user store to a local profile when a user logs on.

Warning:

If you select **Delete excluded files or folders**, Profile Management deletes your excluded files and folders from the user store permanently. If you include the excluded files and folders again, Profile Management still deletes them from the cached local profile when you log on.

For your changes to take effect, run the `gpupdate /force` command from the command prompt. Log off and log back on. For more information, see <https://docs.microsoft.com/en-us/windows-server/administration/windows-commands/gpupdate>.

To enable logon exclusion check using the .ini file, do the following:

1. Open the Profile Management .ini file.
2. Add the EnableLogonExclusionCheck item in the [General Settings] section.
3. Set a value for the EnableLogonExclusionCheck item as follows:
 - To ignore the excluded files and folders specified in the exclusion list from the user store, set the value to 1; for example, EnableLogonExclusionCheck=1.
 - To delete the excluded files and folders specified in the exclusion list from the user store, set the value to 2; for example, EnableLogonExclusionCheck=2.
 - To disable the check, set the value to 0; for example, EnableLogonExclusionCheck=0.
4. Save and close the Profile Management .ini file.
5. Run the `gpupdate /force` command to make your changes take effect.

Configuration precedence:

1. If this setting isn't configured in Group Policy Objects (GPOs), the value in the .ini file is used.
2. If this setting is configured in neither the GPOs nor the .ini file, the policy is disabled.

Stream user profiles

August 6, 2024

By default, Citrix Profile Management fetches the entire user profile from the user store to the local computer when a user logs on. Large files in the user profile can cause a slow logon. To improve the user logon experience, you can enable the profile streaming feature.

With this feature enabled, Profile Management fetches profile files and folders only when they are accessed after logon.

Note:

The user profile includes files, folders, and registry entries. This feature applies to files and folders but not to registry entries. Registry entries are always fetched on user logon.

Enable the profile streaming feature

Enable the profile streaming feature by using the following policies:

- **Profile streaming.** With this policy enabled, profile *files* are fetched to the local computer when the user accesses them.
- **Enable profile streaming for folders.** With this policy enabled, profile *folders* are fetched to the local computer when the user accesses them.

Follow these steps to enable the policies:

1. Open the Group Policy Management Editor.
2. Access **Policies > Administrative Templates: Policy definitions (ADMX files) > Citrix Components > Profile Management > Streamed user profiles.**
3. Double-click **Profile streaming.** Select **Enabled**, and then click **OK.**
4. Double-click **Enable profile streaming for folders.** Select **Enabled**, and then click **OK.**

Enable enhancements for profile streaming

After you enable the profile streaming feature, you can apply a range of enhancements based on your needs.

Example 1: Users reported slow loading of large profile files. In this case, enable the **Always cache** policy and specify a minimum size for large files. Profile Management caches files larger than that size to the local profile *during* user logons.

Example 2: In your organization, users access certain profile folders frequently. Therefore, you want to fetch those folders to the local profile on user logon even if the profile streaming is enabled. To achieve this goal, enable the **Profile Streaming Exclusion list - directories** policy and exclude the folders from profile streaming.

Enable the enhancements as needed. Detailed steps are as follows:

1. Access **Policies > Administrative Templates: Policy definitions (ADMX files) > Citrix Components > Profile Management > Streamed user profiles**.
2. To reduce load times for large files, enable Profile Management to cache large files to the local profile *during* logon. Detailed steps are as follows:
 - a) Double-click **Always cache**.
 - b) Select **Enabled**.
 - c) Set a lower limit (MB) on the size of profile files to cache. To cache the entire profile, set the limit to zero.

Notes:

- Any files that exceed the limit are cached to the local profile as soon as Profile Management starts the back-end processing thread *during* user logons.
- Any files that are below the limit are still fetched to the local profile when users access them.

- d) Click **OK**.
3. To apply profile streaming only to certain user groups in your domain, follow these steps:
 - a) Double-click **Streamed user profile groups**.
 - b) Select **Enabled**.
 - c) Enter a list of user groups. Press **Enter** to separate entries.
 - d) Click **OK**.

Note: By default, the policy is disabled and profile streaming applies to all user groups in your domain.

4. To exclude certain profile folders and files from profile streaming, follow these steps:
 - a) Double-click the **Profile Streaming Exclusion list - directories** policy.
 - b) Select **Enabled**.
 - c) Click **Show**.
 - d) Add folders that you do not want Profile Management to stream. For more information, see [enable profile streaming exclusion](#), later in this article.
5. To ensure an optimal logon experience in concurrent sessions of the same user, follow these steps:
 - a) Double-click **Enable profile streaming for pending area**.
 - b) Select **Enabled**.
 - c) Click **OK**.

For more information, see profile streaming for the pending area, later in this article.

For your changes to take effect, run the `gpupdate /force` command from the command prompt. For more information, see <https://technet.microsoft.com/en-us/library/bb490983.aspx>.

Configuration precedence

Configuration precedence for each policy in **Streamed user profiles** is as follows:

- If **Profile streaming** isn't configured in the GPO or in the .ini file, **Profile streaming** is disabled.
- If **Always cache** isn't configured in the GPO, the value from the .ini file is used. If this setting isn't configured here or in the .ini file, it is disabled.
- If **Streamed user profile groups** is disabled, all user groups are processed. If this setting isn't configured in the GPO, the value from the .ini file is used. If this setting isn't configured in the GPO or in the .ini file, all users are processed.
- If **Enable profile streaming for folders** isn't configured in the GPO or in the .ini file, profile streaming for folders is disabled.
- If **Enable profile streaming exclusion** isn't configured in the GPO or in the .ini file, all folders are streamed.
- If **Enable profile streaming for pending area** isn't configured in the GPO or in the .ini file, profile streaming for the pending area is disabled.

Enable profile streaming exclusion

When profile streaming exclusion is enabled, Profile Management does not stream folders in the exclusion list. All folders and files in the exclusion list are fetched immediately from the user store to the local computer when a user logs on.

To enable profile streaming exclusion, follow these steps:

1. Under Profile Management, double-click **Streamed user profiles**.
2. Double-click the **Profile Streaming Exclusion list - directories** policy.
3. Select **Enabled**.
4. Click **Show**.
5. Add folders that you do not want Profile Management to stream. The folder names can be specified as absolute paths or as paths relative to the user profile (%USERPROFILE%). Use that variable to locate the profile but do not enter the variable itself in this policy. Omit initial backslashes from paths.

For example:

- Desktop. The Desktop folder is fetched on user logons.

- MyApp\tmp. The %USERPROFILE%\MyApp\tmp folder is fetched on user logons.

If this setting isn't configured here, the following folders in the .ini file are excluded by default:

- AppData\Local\Microsoft\Credentials
- Appdata\Roaming\Microsoft\Credentials
- Appdata\Roaming\Microsoft\Crypto
- Appdata\Roaming\Microsoft\Protect
- Appdata\Roaming\Microsoft\SystemCertificates

Note:

- This policy only takes effect when Profile Streaming is enabled.
- This policy does not support wildcards * and ?.
- Type [Enter](#) to separate entries.
- When manually editing the profile streaming exclusion list, you must add the preceding default excluded folders to avoid logons hanging.

Profile streaming for the pending area

Profile Management uses the [pending area](#) to temporarily store profile files and folders changed in concurrent sessions of the same user. By default, that area is an exception to the profile streaming feature. Even with the feature enabled, files and folders in that area are still fetched to the local profile when users log on.

To ensure an optimal logon experience in concurrent sessions of the same user, enable the **Enable profile streaming for pending area** feature as an enhancement to the profile streaming feature. With this policy enabled, Profile Management fetches files and folders in the pending area to the local profile when users access them instead of when they log on. If there are large files in that area, user logon time reduces significantly.

Replicate user stores

August 6, 2024

With the **Replicate user stores** policy, you can replicate the user store to multiple paths on each user logon and logoff. Doing so provides profile redundancy and guarantees a high level of availability for user profiles.

Note:

- This feature applies to both file-based and container-based profile solutions.
- Replicated profile containers provide profile redundancy for user logons but not for in-session failover.
- Enabling the policy increases system I/O and might prolong logoffs.

How it works

In addition to the user store configured using the [Path to user store policy](#), you can configure more user stores using the **Replicate user stores** policy. When multiple user stores are deployed and configured in your environment, Profile Management works as follows:

- During user *logon*, Profile Management selects the user store with the latest profile for the user. If multiple user stores have the latest profile, by default, Profile Management selects the earliest configured store. You can also enable Profile Management to select the store with the best access performance. For more information, see [Change the user store selection method](#).
- During user *logoff*, Profile Management writes the local profile back to all user stores.

Configure replicated user stores

To provide profile redundancy, set up additional user stores beyond the user store configured using the [Path to user store policy](#). To configure replicated user stores using Group Policy, follow these steps:

1. Open the Group Policy Management Editor.
2. Access **Computer Configuration > Administrative Templates > Citrix Components > Profile Management > Advanced settings**, and then double-click the **Replicate user stores** policy.
3. Set the policy to **Enabled**.
4. Click **Show** next to **Paths to replicate a user store**.
5. In the **Value** field, enter the path for a replicated user store. Repeat this step for the other replicated user stores.

If the profile container is enabled for part of the user profile, you can replicate container-based profiles and file-based profiles to different locations. To do so, enter the path in this form: `<path to the replicated container-based profiles>|<path to the replicated file-based profiles>`. For example: `\\path_a|\\path_b` indicates that Profile Management replicates container-based profiles to `\\path_a` and file-based profiles to `\\path_b`.

6. Click **OK** and **OK** again.

Note:

To synchronize files and folders modified during a session to the user store, enable the [Enable active write-back](#) policy.

Change the user store selection method

By default, when multiple user stores are available, Profile Management selects the store with the latest profile. If there are multiple options, it selects the one configured earliest. When necessary, you can enable Profile Management to select the store with the best access performance. Detailed steps are as follows:

1. Open the Group Policy Management Editor.
2. Access **Computer Configuration > Administrative Templates > Citrix Components > Profile Management > Advanced settings**, and then double-click the **User store selection method** policy.
3. Set the policy to **Enabled**.
4. In the **Selection method** field, select **Access performance**. To revert to the configuration order-based selection, select **Configuration order**.
 - **Configuration order.** Profile Management selects the earliest configured store.
 - **Access performance.** Profile Management selects the store with the best access performance.
5. Click **OK**.

Configuration precedence:

1. If this setting isn't configured here, the value from the .ini file is used.
2. If this setting isn't configured here or in the .ini file, **Configuration order** is used.

Tip:

To trace a store selection event at user logon, open **Windows Event Viewer** on the machine, go to **Windows Logs > Applications**, and apply a filter for **Citrix Profile Management events** with the ID **5**.

Set up profile containers

August 6, 2024

Important:

This feature does not work on Windows 7.

Large folders in a user profile can cause a slow user logon. To improve the logon experience, Profile Management provides the profile container, a VHDX-based profile solution. This solution lets you store the profile folders of your choice on the VHDX profile disk. When users log on, the VHDX profile disk is mounted and the profile folders are available immediately.

You can achieve one of the following goals using profile containers:

- Set up the container-based profile solution: Store the entire user profile in the profile container.
- Optimize user experiences for the file-based profile solution: Store a portion of the user profile in the profile container.

Workflow

The general workflow for deploying the profile container is as follows:

1. (Optional) Customize the storage capacity and path for profile containers.
2. Enable the profile container in a way that suits your needs:
 - Enable the profile container for a portion of the user profile (file-based profile optimization solution)
 - Enable the profile container for the entire user profile (container-based profile solution)

Note:

With the container-based profile solution enabled, the following user profiles (if any) are automatically migrated to the container upon its first use:

- Local Windows user profile
- User profiles from the Citrix file-based profile solution

3. To prevent the profile container from bloating, exclude folders and files.
4. If multi-session scenarios are common in your deployment, enable multi-session write-back for profile containers as needed.

5. To enable profile containers to dynamically grow in size as the profile data expands, enable and configure VHD auto-expansion for profile containers.
 6. To reduce the storage costs resulting from identical files in user profiles, you can enable and configure file deduplication policies:
 - a) [Specify files to deduplicate from profile containers.](#)
 - b) (Optional) [Specify files to exclude from deduplication.](#)
 - c) (Optional) [Specify the minimum size of files to deduplicate from profile containers.](#)
 7. (Optional) Grant AD users Read access to profile containers.
 8. If you've enabled the profile container for the entire user profile (container-based profile solution), you can enable one of the following policies as necessary:
 - To provide profile redundancy to guarantee a high level of profile availability, enable [Replicate user stores](#).
 - To cache the user profile on the local computer, enable local caching for profile containers.
 - To allow only one access to profile containers at a time, enable exclusive access to profile containers.
- Note:**

If the **enable exclusive access to profile containers** setting is enabled for profile containers, the **Enable multi-session write-back for profile containers** setting is automatically disabled.
- [Specify whether to log off users when profile container is not available during logon.](#)

Considerations

When the container-based profile solution is enabled, be aware of these considerations:

- The file-based profile solution is disabled automatically and the following policies no longer apply:
 - Profile streaming
 - Exception: profile streaming applies to the profile container only when the *Enable local caching for profile containers* policy is enabled. For more information, see [Enable local caching for profile containers](#).
 - File System
 - Active write-back

- Delete locally cached profiles on logoff

To view policies that apply to the container-based profile solution, see [Policies for file-based and container-based solutions](#).

- To maintain backward compatibility with the Search index roaming for Outlook feature, Profile Management keeps the two VHDX disks that are used to store the following files, respectively:
 - Outlook search index database
 - Offline Outlook Data Files (.ost)

(Optional) Customize the storage capacity and path for profile containers

By default, the profile container is stored in the user store with a default storage capacity of 50 GB.

For example, you configure the path of the user store as:

```
\\myprofileserver\profiles$\%username%.%domain%\!ctx_osname!!  
ctx_osbitness!.
```

The profile container is then stored in:

```
\\myprofileserver\profiles$\%username%.%domain%\!ctx_osname!!  
ctx_osbitness!\ProfileContainer\!ctx_osname!.
```

You can specify a different network location for the profile container and change its default storage capacity. For more information, see [Specify the storage capacity and path for VHD files](#).

Enable the profile container for a portion of the user profile

To reduce logon time with the user store, you can enable the profile container feature and add those large profile folders to the profile container.

Note:

The folders you add to the profile container also exist in the user store. After you enable the profile container feature, Profile Management keeps the folders synchronized between the profile container and the user store.

Suppose you enable the profile container feature and then you disable it. To ensure a consistent user profile, Profile Management synchronizes the user store profile with a profile container. This synchronization occurs during the user logon. Folders in the exclusion list are not copied to the user store.

1. Open the Group Policy Management Editor.
2. Under **Computer Configuration > Policies > Administrative Templates: Policy definitions (ADMX files) > Citrix Components > Profile Management > Profile container settings**, double-click the **Profile container** policy.

3. Select **Enabled**.
4. Click **Show** and add the folders in the form of relative paths to the user profile. We recommend that you add folders that contain large cache files. For example, add the Citrix Files content cache folder to the list: `AppData\Local\Citrix\Citrix Files\PartCache`.

Enable the container-based profile solution

To enable the container-based profile solution, follow these steps:

1. Open the Group Policy Management Editor.
2. Under **Computer Configuration > Policies > Administrative Templates: Policy definitions (ADMX files) > Citrix Components > Profile Management > Profile container settings**, double-click the **Profile container** policy.
3. Select **Enabled**.
4. Click **Show**, and then add an asterisk (*) to the profile container list.
5. Click **OK**.

(Optional) Include and exclude folders and files

To prevent the profile container from bloating, you can exclude folders and files from it. If needed, you can include folders and files when their parent folders are excluded.

Exclude folders from the profile container

Important:

If you enable the profile container for the entire user profile, the folder redirection setting still takes effect. Do not put folders to be redirected in the **Folders to exclude from profile container** list. Otherwise, folder redirection does not work.

1. Under **Profile Management > Profile container settings**, double-click the **Folders to exclude from profile container** policy.
2. Select **Enabled**.
3. Click **Show**, and then enter the folders to exclude in the form of relative paths to the user profile.

Wildcards in folder names are supported but are not applied recursively. Example:

- `Desktop` indicates the `Desktop` folder.
- `Downloads*` indicates all immediate subfolders of the `Downloads` folder.

Note:

If you enable the profile container for the entire user profile (*container-based profile solution*), the `appdata\local\temp` folder is automatically excluded from the profile container.

Configuration precedence:

1. If the setting is disabled, no folder is excluded.
2. If the setting isn't configured here, the value from the .ini file is used.
3. If the setting isn't configured either here or in the .ini file, no folder is excluded.

Include folders into the profile container

To include subfolders of the excluded folders in the profile container, follow these steps:

1. Under **Profile Management > Profile container settings**, double-click the **Folders to include in profile container** policy.
2. Select **Enabled**.
3. Click **Show**, and then enter the folders to include in the form of relative paths to the user profile.

Be aware of the following:

- Folders on this list must be subfolders of the excluded folders. Otherwise, this setting does not work.
- Wildcards in folder names are supported but are not applied recursively.
- Enabling the policy and configuring an empty list have the same effect as disabling the setting.

Configuration precedence:

1. If the setting isn't configured here, the value from the .ini file is used.
2. If the setting isn't configured either here or in the .ini file, folders not on the exclusion list are included in the profile container.

Include files into the profile container

After you exclude a folder from the profile container, you can include files inside the folder into the profile container. Detailed steps are as follows:

1. Under **Profile Management > Profile container settings**, double-click the **Files to include in profile container** policy.
2. Select **Enabled**.
3. Click **Show**, and then enter the files to include in the form of relative paths to the user profile.

Be aware of the following:

- Files on this list must be inside the excluded folders. Otherwise, this setting does not work.
- Wildcards in file names are applied recursively. To restrict the policy only to the current folder, use the vertical bar (|).
- Starting with Profile Management 2112, wildcards in folder names are supported but are not applied recursively.

Examples:

- `Desktop\Desktop.ini` indicates the `Desktop\Desktop.ini` file.
- `AppData*.tmp` indicates all files with the `.tmp` extension in the `AppData` folder and its subfolders.
- `AppData*.tmp|` indicates all files with the `.tmp` extension only in the `AppData` folder.
- `Downloads*\a.txt` indicates `a.txt` in any immediate subfolder of the `Downloads` folder.

Enabling the policy and configuring an empty list have the same effect as disabling the setting.

Configuration precedence:

1. If the setting isn't configured here, the value from the `.ini` file is used.
2. If the setting isn't configured either here or in the `.ini` file, files not on the exclusion list are included in the profile container.

Exclude files from the profile container

Starting with Profile Management 2112, you can exclude files from the profile container. Detailed steps are as follows.

1. Under **Profile Management > Profile container settings**, double-click the **Files to exclude from profile container** policy.
2. Select **Enabled**.
3. Click **Show**, and then enter the files to exclude in the form of relative paths to the user profile.

Be aware of the following:

- Wildcards in file names are applied recursively. To restrict the policy only to the current folder, use the vertical bar (|).
- Starting with Profile Management 2112, wildcards in folder names are supported but are not applied recursively.

Configuration precedence:

1. If the setting is disabled, no file is excluded.
2. If the setting isn't configured here, the value from the `.ini` file is used. If the setting isn't configured either here or in the `.ini` file, no file is excluded.

(Optional) Enable and configure VHD auto-expansion

User profiles typically grow over time. To simplify storage management, enable the VHD auto-expansion feature for profile containers. With this feature enabled, when the container reaches 90% utilization, it automatically expands by 10 GB, with a maximum capacity of 80 GB. If needed, you can customize these default settings to meet your specific needs.

Tip:

You can use [user-level policy settings](#) for more granular control over VHD auto-expansion settings. Your organization can have a standard set of auto-expansion settings while providing unique settings, such as larger maximum capacity, for specific users.

1. Open the Group Policy Management Editor.
2. Enable VHD auto-expansion using the following steps:
 - a) Go to **Computer Configuration > Policies > Administrative Templates: Policy definitions (ADMX files) > Citrix Components > Profile Management > Profile container settings**.
 - b) Double-click the **Enable VHD auto-expansion for profile container** policy.
 - c) Select **Enabled**.
 - d) Click **OK**.
3. To change the default storage utilization percentage at which profile containers trigger auto-expansion, follow these steps:
 - a) Go to **Computer Configuration > Policies > Administrative Templates: Policy definitions (ADMX files) > Citrix Components > Profile Management > Advanced settings**.
 - b) Double-click the **Profile container auto-expansion threshold** policy.
 - c) Select **Enabled**.
 - d) In the **Auto-expansion threshold (%)** field, enter a percentage as needed.
 - e) Click **OK**.
4. To change the amount of storage capacity by which profile containers automatically expand, follow these steps:
 - a) Go to **Computer Configuration > Policies > Administrative Templates: Policy definitions (ADMX files) > Citrix Components > Profile Management > Advanced settings**.
 - b) Double-click the **Profile container auto-expansion increment** policy.
 - c) Select **Enabled**.
 - d) In the **Auto-expansion increment (in GB)** field, enter a number as needed. The default is 10 (GB).
 - e) Click **OK**.

5. To change the maximum storage capacity to which profile containers can automatically expand, follow these steps:
 - a) Go to **Computer Configuration > Policies > Administrative Templates: Policy definitions (ADMX files) > Citrix Components > Profile Management > Advanced settings**.
 - b) Double-click the **Profile container auto-expansion limit** policy.
 - c) Select **Enabled**.
 - d) In the **Auto-expansion limit (in GB)** field, enter a number as needed. The default is 80 (GB).
 - e) Click **OK**.

(Optional) Enable multi-session write-back for profile containers

Profile Management supports concurrent access to the profile container by default. However, among all concurrent sessions, only one session has read/write permission and can merge profile changes into the container.

The following is how Profile Management processes concurrent access:

- On session logon:
 - Checks whether a read/write session exists. If one is found, the current session becomes read-only. Otherwise, it's a read/write session.
- On session logoff:
 1. Dismounts the profile container.
 2. Discards profile changes if the current session is read-only.
 3. Merges profile changes of the read/write session to the profile container if there are no other concurrent sessions.

To enable multi-session write-back, use the [Enable multi-session write-back for profile containers](#) policy.

(Optional) Enable exclusive access to profile containers

By default, profile containers allow concurrent access. If needed, you can disable concurrent access to profile containers through **Profile container settings > Enable exclusive access to VHD containers**. As a result, profile containers allow only one access at a time.

Note:

- This setting applies only to profile containers that are enabled for the entire user profile.
- If this setting is enabled for profile containers, the **Enable multi-session write-back for**

profile containers setting is automatically disabled.

For more information, see [Enable exclusive access to VHD containers](#).

(Optional) Enable local caching for profile containers

The **Enable local caching for profile containers** feature takes effect only when the profile container is enabled for the entire user profile. If you enable the **Enable local caching for profile containers** policy, during user logon, the user's profile in the profile container is cached in the user's local user profile.

Important:

Applications that work only with the container-based profile solution, such as OneDrive, might not work properly when this policy is enabled. To ensure OneDrive functions correctly, either disable this policy or enable the OneDrive container policy.

By default, the entire user profile is cached during user logon. To reduce user logon time, you can enable the **Profile streaming** policy. As a result, the profile folders in the user profile are cached on demand after logon.

(Optional) Specify whether to log off users when the profile container is not available during logon

By default, when the profile container is unavailable during user logon, users log on using temporary profiles instead. However, this behavior leads to data loss for any changes made during the session. Alternatively, you can enable the **Log off users when profile container is not available during logon** policy to force log-off users in such cases. With this policy enabled, users receive an error message that states **Unable to set up your profile: profile container is not available. Clicking OK will log you off, and any changes made during this session will be lost.** Clicking **OK** in this message immediately logs them off. If necessary, you can also customize the error message when enabling this policy.

To enable this policy using GPO, follow these steps:

1. Under **Profile Management > Profile container settings**, double-click the **Log off users when profile container is not available during logon** policy.
2. Select **Enabled**.
3. In the **Error message** field, enter the message users will see when the profile container isn't available during logon. Leaving it empty will display a default message.
4. Click **OK**.

Note:

When configuring Profile Management policies using Studio, performing the **Disable** action can't disable this policy. Instead, to disable it, edit the policy to change its value to **Disabled**, and then clear the policy checkbox.

Configuration precedence:

1. If this policy is not configured here, the value from the .ini file is used.
2. If this policy is not configured either here or in the .ini file, the setting is disabled.

(Optional) Grant AD users Read access to profile containers

Applies to: both file-based and container-based profile solutions.

By default, a profile container is accessible only to its owner. To extend its access to other users in your AD domains, you can enable the **Users and groups to access profile container** policy. Profile Management grants **Read & Execute** permission to users and user groups specified in this policy.

Detailed steps are as follows:

1. Under **Profile Management > Profile container settings**, double-click the **Users and groups to access profile container** policy.
2. Select **Enabled**.
3. In the **Users and groups to access profile container** field, click **Show**, and then add AD users and groups to which you want to grant **Read** and **Execute** permission for the container. Use the format `domain name\user or group name` or the Security Identifier (SID) to identify an AD user or group.
4. Click **OK** and **OK** again.

Configuration precedence:

1. If this policy is not configured here, the setting from the .ini file is used.
2. If this policy is not configured either here or in the .ini file, the profile container is accessible only to its owner.

Enable multi-session write-back for profile containers

August 6, 2024

Tip:

For more information about the FSLogix Profile Container, see <https://docs.microsoft.com/en-us/fslogix/configure-profile-container-tutorial>. For more information about Citrix Profile Management profile container, see [Citrix Profile Management profile container](#)

Overview

VHD-based profile solutions such as the FSLogix Profile Container and the Citrix Profile Management profile container do not support saving changes in multi-session scenarios. They let only one session (in read/write mode) write changes. Changes in other sessions (in read-only mode) are discarded.

However, multi-session scenarios are common in use cases of Citrix virtual apps. To ease these use cases, we provide the **Enable multi-session write-back for profile containers** policy. The policy lets you enable multi-session write-back for both FSLogix Profile Container and Citrix Profile Management profile container. If the same user launches multiple sessions on different machines, Profile Management synchronizes and saves changes made in each session to the user's profile container.

During user logon, the user's profile container disk is mounted and I/O requests are redirected to the mounted disk. Profile Management then synchronizes changes from the user store to the local profile.

During the user logoff process, Profile Management works differently depending on which FSLogix Profile Container mode is used in the session:

- If read-only mode is used, Profile Management writes back changes to the user store.
- If read/write mode is used, Profile Management applies changes from the user store to the local profile. Then the changes are merged to the user's profile container.

Note:

The multi-session write-back feature is not compatible with profile streaming if the FSLogix Profile Container is in use.

The following events qualify as changes:

- Creation
- Modification
- Deletion
- Rename

Write-back strategy

Profile Management uses the “last write wins” strategy to apply changes.

- For file/folder creation and modification, it writes back changes by comparing the file/folder last write time.
- For file/folder deletion and rename, it writes back changes by comparing the time stamps associated with the changes. Profile Management logs time stamps when changes occur.

Enable multi-session write-back for profile containers

You can use the multi-session write-back feature by setting the **Enable multi-session write-back for profile containers** policy to **Enabled**. The policy is set to **Disabled** by default.

- To use the feature for the FSLogix Profile Container, complete the following steps:
 - FSLogix Profile Container
 - * Verify that FSLogix Profile Container is installed and enabled.
 - * Verify that the profile type is set to **Try for read-write profile and fall back to read-only**.
 - Citrix Profile Management
 - * Set the **Enable Profile Management** policy to Enabled.
 - * Set the **Path to user store** policy with a valid path.
 - * (Optional) Set the **Processed groups** and **Excluded groups** policies. Verify that the user groups to process are consistent with those groups in the FSLogix Profile Container.
 - * Set the **Enable multi-session write-back for profile containers** policy to **Enabled**. You can set the policy in a GPO or in Citrix Studio. See instructions later in this article.
- To use the multi-session write-back feature for the Citrix Profile Management profile container, complete the following steps:
 - Set the **Enable multi-session write-back for profile containers** policy to **Enabled**.
 - [Enable the Citrix Profile Management profile container feature](#).

To enable the **Enable multi-session write-back for profile containers** policy, follow these steps:

1. Open the Group Policy Management Editor.
2. Under **Computer Configuration > Administrative Templates > Citrix Components > Profile Management > Advanced settings**, double-click the **Enable multi-session write-back for profile containers** policy.
3. Select **Enabled** and then click **OK**.

For your changes to take effect, run the `gpupdate /force` command from the command prompt on the machine where Profile Management is installed. Log off from all sessions and then log back on.

For more information, see <https://docs.microsoft.com/en-us/windows-server/administration/windows-commands/gpupdate>.

Control access to applications

August 6, 2024

The app access control feature lets you control access to applications using rules. With this feature, you can streamline the management of applications and images. For example, you can deliver identical machines to different departments while meeting their unique application requirements, thus reducing the number of images.

This article walks you through the process of enabling app access control and configuring the control rules. It also provides an example of using this feature to simplify image management in virtual environments.

Note:

This feature applies to both Active Directory (AD) and non-domain-joined (NDJ) environments.

Overview

With the app access control feature, you can hide applications from users, machines, and processes by configuring hiding rules.

A hiding rule consists of two parts:

- **Objects to hide.** Files, folders, and registry entries you want to hide for an application.
For example, to hide an application, you must specify all objects associated with this application, such as files, folders, and registry entries.
- **Assignments.** Users, machines, and processes you want to hide the application from.

Assignment types

Assignments in hiding rules come in three categories: processes, users, and machines. The specific assignment types are listed as follows:

Category	Type
Processes	Not applicable

Category	Type
Users	<ul style="list-style-type: none"> • AD and Azure Active Directory (AAD) users • AD and AAD user groups
Machines	<ul style="list-style-type: none"> • AD, AAD, and NDJ machines • Groups of AD Machines (grouped in Organizational Units (OUs)) • Groups of NDJ machines (grouped in machine catalogs)

Note:

- In the context of app access control, OUs are used as containers only for machines, but not for users. As a result, an OU assignment hides the app only from machines in the OU and not from users in the OU.
- NDJ machines are limited to those machines that Citrix creates and power manages.

When a hiding rule has multiple assignments configured, be aware of the following considerations:

- If those assignments are of the same category (for example, *user A* and *user group B*), the application is hidden from all objects specified in those assignments (*user A* and all users in *user group B*).
- If those assignments are of different categories (for example, *user A* and *machine X*), the application is hidden when the conditions specified in all those assignments are met (when *user A* signs in to *machine X*).
- If those assignments are of the *process* category, the application is hidden from all processes specified in those assignments.

Note:

If no assignments are configured for a rule, the application specified in the rule is hidden.

Workflow

With the app access control feature, Profile Management can hide applications from users, machines, and processes based on the rules you provide. At a high level, the workflow of implementing app access control is as follows:

1. Create and generate hiding rules. There are two tools that you can use:
 - GUI-based tool – [WEM Tool Hub > Rule Generator for App Access Control](#)
 - PowerShell tool – available with the Profile Management installation package. For more information, see [Create, manage, and deploy rules using Rule Generator](#).

2. Use GPOs to apply hiding rules to machines in your environment. For more information, see [Enable app access control using GPOs](#).

Create, manage, and deploy rules using Rule Generator

This section guides you through using the PowerShell-based Rule Generator to create, manage, and deploy rules.

Before you begin, make sure that the machine where you run the tool meets the following requirements:

- Runs on Windows 10 or 11, or Windows Server 2016, 2019, or 2022.
- (For AD environments only) Is in the same domain as your users and machines.

The general procedure is as follows:

1. Run **Windows PowerShell** as an administrator.
2. Access the `\tool` folder in the Profile Management installation package, and then run **CPM_App_Access_Control_Config.ps1**.
3. Follow the onscreen instructions to create, manage, and generate hiding rules:
 - a) View each application installed on the machine and its state:
 - **Not configured**. No rules are configured for the application.
 - **Configured**. One or more rules are configured for the application and none of them are applied to machines.
 - **Configured and applied**. One or more rules are configured for the application and at least one rule is applied to machines.

```
List of apps to manage:
Index Status      Name
-----
1 Not configured Adobe Acrobat (64-bit)
2 Not configured AppUp.IntelGraphicsExperience
3 Not configured AppUp.ThunderboltControlCenter
4 Not configured Citrix Secure Access
5 Not configured Citrix workspace 2303
6 Not configured DolbyLaboratories.DolbyAccess
7 Not configured ELANMicroelectronicsCorpo.ELANTrackPointforThinkpa
8 Not configured Git
9 Not configured Google Chrome
```

- b) From the application list, select an application you want to hide by entering its index. All files, folders, and registry entries associated with the application appear.

```

App details:
File and registry list:
Index Type Path
-----
1 Folder C:\Program Files\Git
2 Registry key HKEY_LOCAL_MACHINE\SOFTWARE\Microsoft\Windows\CurrentVersion\Uninstall\Git_is1
3 File c:\users\huanw\AppData\Roaming\Microsoft\Internet Explorer\Quick Launch\User Pinned\Taskbar\Git Bash.lnk
4 Folder C:\ProgramData\Microsoft\Windows\Start Menu\Programs\Git
5 File C:\ProgramData\Microsoft\Windows\Start Menu\Programs\Git\Git Bash.lnk
6 File C:\ProgramData\Microsoft\Windows\Start Menu\Programs\Git\Git CMD.lnk
7 File C:\ProgramData\Microsoft\Windows\Start Menu\Programs\Git\Git GUI.lnk
8 File C:\ProgramData\Microsoft\Windows\Start Menu\Programs\Git\Git Release Notes.lnk

Assignment list:
No assignments configured. This app is not visible to any users, computers, or processes.
*****

Do you want to add a file or registry entry for this app? Or want to delete one?

[1] Discard the changes you made to the app and continue adding rules for other apps
[2] Save your changes and continue adding rules for other apps
[3] Generate the rules for deployment to machines
    If no assignments are configured, this app is not visible
-----
[4] Add files
[5] Add folders
[6] Add registry keys
[7] Add registry values
[8] Delete specific entries
[9] Delete all entries
-----
[0] Go to the next step to manage assignments
Enter value:
    
```

- c) To hide an additional file, folder, or registry entry for the selected application, select the corresponding action type, and then add the object by entering its name and path. Repeat this step to add more.

Considerations:

- System environment variables (such as %windir%) in the paths are supported while user environment variables (such as %appdata%) aren't.
- Wildcards * and ? are supported for files and folders. When there are multiple asterisks (**) in a string, characters between two asterisks are ignored. For example, in the string c:\users\Finance*Manangement*, the characters *Management* are treated as a single asterisk (*).

Note:

You can also manually define an application by associating it with certain files, folders, and registry entries.

- d) Configure assignments for the rule. In detail, specify the assignment type and then enter the specific objects that you want to hide the application from. For more information, see the following table.

Assignment type	Description
Azure AD groups	Collect the groups' SIDs and names using AAD/NDJ object selector in the WEM web console, and then enter them in the form: <code>sid1\name1 sid2\name2</code> . Example: <code>/azuread/989c2938-6527-4133-bab1-f3860dd15098\TestGroup1 /azuread/82bdde32-d5d9-4d64-b0ff-9876d4488d05\TestGroup2</code>

4. Repeat step 3 to create hiding rules for other applications.
5. Follow the onscreen prompt to generate the raw data for the rules you configured and then save it in a .txt file for future use.
6. To test whether the rules work as expected, follow the onscreen prompt to deploy them to this machine or a group of machines.

Note:

We don't recommend using this tool to deploy rules to production environments.

Enable app access control using GPOs

After you create and generate hiding rules, you can use GPOs to apply them to machines in your environment.

To apply control rules to machines using a GPO, follow these steps:

1. Open the Group Policy Management Editor.
2. Access **Policies > Administrative Templates: Policy definitions (ADMX files) > Citrix Components > Profile Management > App access control**.
3. Double-click **App access control**.
4. In the policy window that appears, select **Enabled**.
5. Open the .txt file where you saved the generated rules, copy the content, and paste it to the **App access control rules** field.
6. Click **OK**.

The configuration precedence for the feature is as follows:

1. If this setting isn't using a GPO, Studio, or WEM, the value from the .ini file is used.
2. If this setting isn't configured anywhere, the feature is disabled.

Example

This section uses an example to guide you through implementing app access control for an image.

Requirements

Requirements in this example are as follows:

- Use a single image to create virtual machines for the Sales, HR, and Engineering departments.
- Control access to the following applications:
 - Microsoft Excel: invisible to users in the HR department.
 - Visual Studio Code: invisible to users in the Sales or HR department.

Solution

Install Profile Management to control access to installed applications.

Install a template machine

Install a template machine for capturing the image. The procedure is as follows:

1. Join a new machine to the same AD domain as your users and machines.
2. Install the following software on the machine:
 - Windows 10 or 11, or Windows Server 2016, 2019, or 2022, as needed
 - Profile Management version 2303 or later
 - All required applications

Create and generate hiding rules

1. On the template machine, use the Rule Generator tool to create and generate hiding rules.
 - Rule 1: To hide Microsoft Excel from users in the HR department (Application: Microsoft Excel; Assignment: HR user group)
 - Rule 2: To hide Visual Studio Code from users in the Sales or HR department (Application: Visual Studio Code; Assignments: Sales user group and HR user group)
2. Generate raw data for the two rules and save it to a .txt file.

For more information about how to use the tool, see [Create, generate, and deploy rules using Rule Generator](#).

Now you can capture the image from the template machine.

Enable app access control using GPOs

After virtual machines are created, use GPOs to centrally enable app access control and apply the generated rules to machines. For more information, see [Enable app access control using GPOs](#).

Enable and configure user-level policy settings

August 6, 2024

By default, most Profile Management policies work at the machine level. After you apply those policy settings to a container (site, domain, or OU), they apply to machines within that container regardless of who logs on to them.

With the *user-level policy settings* feature enabled, those machine-level policies can work at the user level—you can configure user- or group-specific settings for them. After you apply those settings to a container, they apply only when the specified users or users in the specified groups log on to machines within that container.

If setting conflicts occur, Profile Management handles them using this priority order:

1. User-specific settings
2. User group-specific settings
3. Machine-level settings

Configuration procedure

To enable and configure user-level policy settings, follow this procedure:

1. Enable user-level policy settings
2. Configure policy settings for users or groups
3. (Optional) Specify the priority order for user groups.

Enable user-level policy settings

To apply user-level Profile Management settings, you must first enable the *user-level policy settings* feature. You can accomplish this goal using various tools such as Group Policy Object (GPO), Workspace Environment Management (WEM), or Web Studio.

To enable the feature using a GPO, follow these steps:

1. Create a GPO and link it to a container that holds target machines, such as a site, domain, or OU.

2. Open the Group Policy Management Editor for the GPO.
3. Access **Policies > Administrative Templates: Policy definitions (ADMX files) > Citrix Components > Profile Management > Advanced settings**.
4. Double-click the **Enable the user-level policy settings** policy.
5. In the policy window that appears, select **Enabled**, and then click **OK**.

The configuration precedence is as follows:

1. If this setting is not configured here, the value from the .ini file is used.
2. If this setting is not configured either here or in the .ini file, it is disabled.

Configure policy settings for users and groups

This section describes how to configure user- or group-specific policy settings.

For example, your organization has the following groups: accounting, sales, marketing, and more. The accounting group uses its own user store and the other groups share a user store. To meet this requirement, configure a user-level **Path to user store** policy for the accounting group, and configure a machine-level **Path to user store** setting for your organization.

To configure a user- or group-specific policy setting, follow these steps:

1. Get the Security Identifiers (SIDs) of users and groups
2. Configure user- or group-specific policy settings

Get Security Identifiers (SIDs) of users and groups

Before you configure user-specific Profile Management settings for a user or group, first get its SID based on its domain name. Detailed steps are as follows:

1. Log on to the Domain Controller.
2. Run **Windows PowerShell** as an administrator.
3. From the PowerShell command line, run one of the following commands as needed:
 - To get the SID of a user, enter `Get-ADUser -Identity <ADUser>`. For example, `Get-ADUser -Identity user5`
 - To get the SID of a group, enter `Get-ADGroup -Identity <ADGroup>`. For example, `Get-ADGroup -Identity HR_Group`
4. Copy the SID from the returned results (for example, `S-1-5-21-2069497100-3951106413-1778302` in the following results).

```
PS C:\Users\Administrator> get-aduser -identity user5
DistinguishedName : CN=user5,CN=Users,DC=bvt,DC=local
Enabled           : True
GivenName        : user5
Name             : user5
ObjectClass      : user
ObjectGUID       : 9cc82246-4939-4068-aeb3-4a6025206c1f
SamAccountName   : user5
SID              : S-1-5-21-2069497100-3951106413-1778302672-1117
Surname          :
UserPrincipalName :
```

Configure user- or group-specific policy settings

You can configure user-level policy settings using:

- Group Policy Preferences (GPP)
- WEM Web Console

Configure settings using GPPs You can configure user-level policy settings using GPPs. As part of Group Policy, GPP settings are automatically distributed to domain-joined computers through GPOs.

To configure a policy setting for a user or group, follow these steps:

1. Open the Group Policy Management Editor for the target GPO.

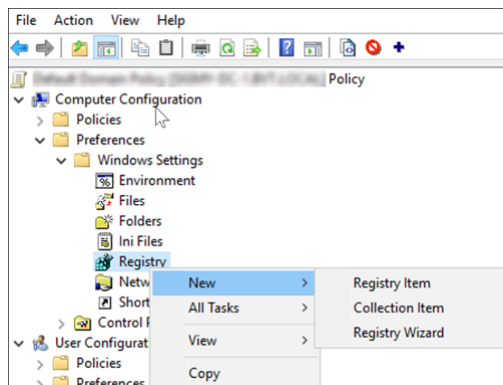

2. Go to **Computer Configuration > Preferences > Windows Settings > Registry**, and then right-click **New > Registry Item**. The **New Registry Properties** window appears.

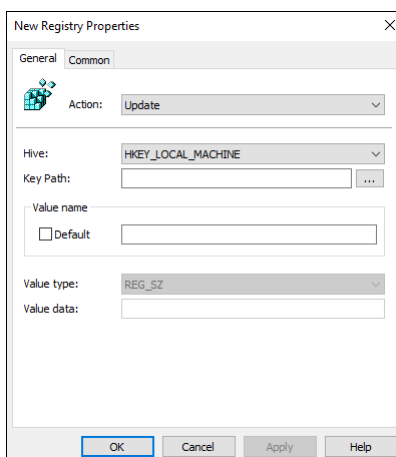

3. On the **General** tab, configure a user- or group-specific policy as described in the following table. You can also see a configuration example for setting the *Path to user store* policy for a user (SID: S-1-5-21-259756655-2069503554-2063751945-1108) in this table.

Field	Description	Example
Action	Leave the default.	Update
Hive	Leave the default.	HKEY_LOCAL_MACHINE
Key Path	Type the registry key path of the user- or group-specific policy. First, get the key path by searching for the policy name in the GPP property settings table. Next, replace <SID> in the key path with the actual SID.	SOFTWARE\Citrix\UserProfileManager\UserGroupConfigs\S-1-5-21-259756655-2069503554-2063751945-1108
Value name	Type the registry value name of the policy. To locate the value name of a policy, search for the policy name in the GPP property settings table.	Pathtouserstore
Value type	Select the registry value type of the policy: REG_SZ or REG_DWORD. To locate the value type of a policy, search for the policy name in the GPP property settings table.	REG_SZ

Field	Description	Example
Value data	Type a registry value data (setting value) for the policy. Value data varies with policies. For more information, see the GPP property settings table.	\\WFRP-DDC-1\UPM1\ #SAMAccountName#\! CTX_OSNAME! CTX_OSBITNESS!

4. Click the **Common** tab, and then select **Remove this item when it is no longer applied**. A message box appears.
5. Click **OK** to confirm your acknowledgment. The **Action** option on the **General** tab changes to **Replace**.
6. Click **OK** or **Apply**. The changes are saved on the Domain Controller. The configuration result (for example, the *Path to user store* policy) is shown.

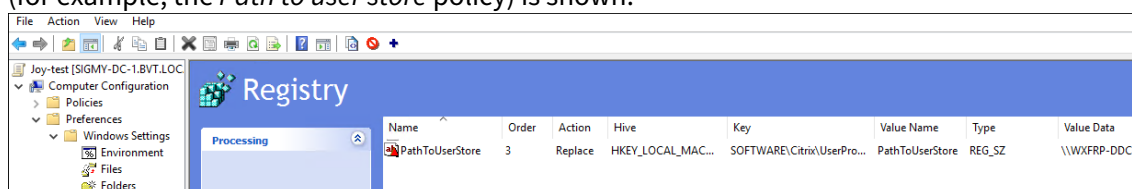

7. To configure more user- or group-specific policy settings for this GPO, repeat steps 2–6 for each. See the configuration example in the Examples section.

To manually sync those policy settings to a computer, run the `groupupdate /force` command on the computer. For user-level policy settings to take effect, log off from the computer and log back on.

As shown in the following screenshot, the user-level policy settings appear in the following registry key, `HKLM\SOFTWARE\Citrix\UserProfileManager\UserGroupConfigs\<SID>`.

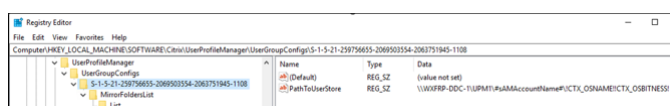

Configure settings using WEM Web Console You can configure user-level policy settings using WEM Web Console. For more information, see [Create a GPO](#) in the Workspace Environment Management Service documentation.

Examples

This section provides several examples for configuring user-level policy settings.

Enable Profile Management Configure the **Enable Profile Management** policy for a user or group using the GPP settings.

Field	Value
Key Path	SOFTWARE\Citrix\UserProfileManager\UserGroupConfigs\S-1-5-21-259756655-2069503554-2063751945-1108
Value name	ServiceActive
Value type	REG_DWORD
Value data	1

Location in the Registry:

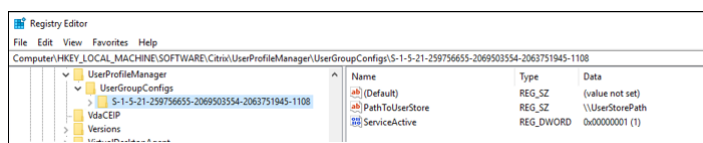

Folders to mirror

Note:

To configure a user-specific policy containing a list of files and folders, you must configure multiple GPP Registry Items.

To configure the **Folders to mirror** policy for a user or group, follow these steps:

1. Enable the policy using these GPP settings.

Field	Value
Key Path	SOFTWARE\Citrix\UserProfileManager\UserGroupConfigs\S-1-5-21-259756655-2069503554-2063751945-1108\MirrorFoldersList
Value name	Enabled
Value type	REG_DWORD
Value data	00000001

Location in the Registry:

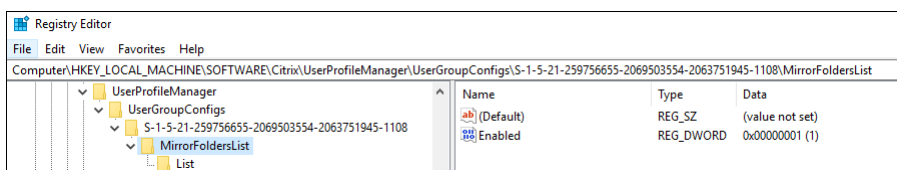

2. Add a folder that you want to mirror (for example, AppData\Local\Packages) using these GPP settings.

Field	Value
Key Path	SOFTWARE\Citrix\UserProfileManager\UserGroupConfigs\S-1-5-21-259756655-2069503554-2063751945-1108\MirrorFoldersList>List
Value name	AppData\Local\Packages
Value type	REG_SZ
Value data	AppData\Local\Packages

Note:

In both the **Value name** and the **Value data** fields, enter the folder to be mirrored.

Location in the Registry:

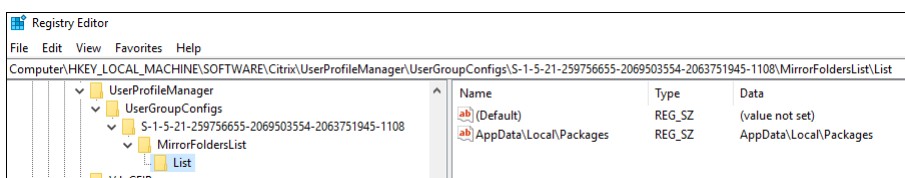

3. Repeat step 2 to add more folders to this policy.

(Optional) Specify the priority order for user groups

When a user belongs to multiple groups with conflicting policy settings, specify the priority order for those groups.

When setting conflicts occur, the policy settings of the group with the highest priority take precedence. If priorities are unspecified, the group with the earliest alphabetical SID is prioritized.

To configure the priority order using a GPO, follow these steps:

1. Open the Group Policy Management Editor.
2. Access **Policies > Administrative Templates: Policy definitions (ADMX files) > Citrix Components > Profile Management > Advanced settings**.

3. Double-click the **Set the priority order for user groups** policy. The policy window appears.
4. Select **Enabled**.
5. In the **Priority order for user groups** field, enter the Security Identifiers (SIDs) or domain names of the groups in descending order of priority, separated by semicolons (;).

Example:

```
ctxxa.local\groupb;S-1-5-21-674278408-26188528-2146851469-1174;
ctxxa.local\groupc;
```

6. Click **OK**.

The configuration precedence is as follows:

1. If this setting is not configured here, the value from the .ini file is used.
2. If this setting is not configured either here or in the .ini file, no priority order is specified.

GPP property settings

This table lists GPP property settings for user-level Profile Management policies.

Note:

This table contains six columns. Part of them might extend beyond the viewport. To view the hidden columns, scroll down and use the horizontal scroll bar.

Policy Name	Key Path	Value Type	Value Name	Value Data	Value Description
Enable Profile Management	SOFTWARE\Citrix\UserProfileManager\ UserGroupConfigs\ <SID>	REG_DWORD	ServiceActive	0:Disable; 1:Enable;	

Policy Name	Key Path	Value Type	Value Name	Value Data	Value Description
Processed groups	SOFTWARE\ Citrix\ UserProfileManager \	REG_DWORD	Enabled	0:Disable; 1:Enable;	
	SOFTWARE\ Citrix\ UserProfileManager \	REG_SZ	List item	List item	
Excluded groups	SOFTWARE\ Citrix\ UserProfileManager \	REG_DWORD	Enabled	0:Disable; 1:Enable;	
	SOFTWARE\ Citrix\ UserProfileManager \	REG_SZ	List item	List item	

Policy Name	Key Path	Value Type	Value Name	Value Data	Value Description
Process logons of local administrators	SOFTWARE\ Citrix\ UserProfileManager \	REG_DWORD	ProcessAdmins	0:Disable; 1:Enable;	
Path to user store	SOFTWARE\ Citrix\ UserProfileManager \	REG_SZ	PathToUserStore	Absolute path or path relative to the home directory.	
Migrate user store	SOFTWARE\ Citrix\ UserProfileManager \	REG_SZ	MigrateUserStore	The user store path that you previously used.	
Active write back	SOFTWARE\ Citrix\ UserProfileManager \	REG_DWORD	PSMidSessionWrite	0:Disable; 1:Enable;	
Active write back registry	SOFTWARE\ Citrix\ UserProfileManager \	REG_DWORD	PSMidSessionWriteReg	0:Disable; 1:Enable;	

Policy Name	Key Path	Value Type	Value Name	Value Data	Value Description
Active write back on session lock and disconnection	SOFTWARE\ Citrix\ UserProfileManager \	REG_DWORD	PSMidSessionWriteBack	0:Disable; 1:Enable;	SessionLock
Offline profile support	SOFTWARE\ Citrix\ UserProfileManager \	REG_DWORD	OfflineSupport	0:Disable; 1:Enable;	
Delete locally cached profiles on logoff	SOFTWARE\ Citrix\ UserProfileManager \	REG_DWORD	DeleteCachedProfiles	0:Disable; 1:Enable;	Logoff
Delay before deleting cached profiles	Software\Policies\Citrix\ProfileManager	REG_DWORD	DeleteDelay		Delay (in seconds).
Migration of existing profiles	SOFTWARE\ Citrix\ UserProfileManager \	REG_DWORD	MigrateWindowsProfiles	0:Disable; 1:Enable;	UserStoreEnabled
	SOFTWARE\ Citrix\ UserProfileManager \	REG_DWORD	MigrateWindowsProfiles	Roaming; 2:Local; 3:Roaming; 4:None;	UserStore

Policy Name	Key Path	Value Type	Value Name	Value Data	Value Description
Automatic migration of existing application profiles	SOFTWARE\ Citrix\ UserProfileManager \ UserGroupConfigs \<SID>	REG_DWORD	ApplicationProfileMigrationEnabled	0:Disable; 1:Enable;	Enabled
Local profile conflict handling	SOFTWARE\ Citrix\ UserProfileManager \ UserGroupConfigs \<SID>	REG_DWORD	LocalProfileConflictHandling	1:Use local profile; 2:Delete local profile; 3:Rename local profile;	
Template profile	SOFTWARE\ Citrix\ UserProfileManager \ UserGroupConfigs \<SID>	REG_SZ	TemplateProfilePath	Path to the template profile.	
	SOFTWARE\ Citrix\ UserProfileManager \ UserGroupConfigs \<SID>	REG_DWORD	TemplateProfileOverridesLocalProfile	0:Disable; 1:Enable;	Template profile overrides local profile
	SOFTWARE\ Citrix\ UserProfileManager \ UserGroupConfigs \<SID>	REG_DWORD	TemplateProfileOverridesRoamingProfile	0:Disable; 1:Enable;	Template profile overrides roaming profile

Policy Name	Key Path	Value Type	Value Name	Value Data	Value Description
	SOFTWARE\ Citrix\ UserProfileManager \	REG_DWORD	TemplateProfileMandatory	0:Disable; 1:Enable;	Template profile used as a Citrix mandatory profile for all logons
Number of retries when accessing locked files	SOFTWARE\ Citrix\ UserProfileManager \	REG_DWORD	LoadRetries	Number of retries.	
Disable automatic configuration	Software\Policies\Citrix\ProfileManager	REG_DWORD	DisableDynamicConfig	0:Disable; 1:Enable;	
Log off user if a problem is encountered	Software\Policies\Citrix\ProfileManager	REG_DWORD	LogOffIfMoreThanOneProfile	0:Disable; 1:Enable;	
Customer Experience Improvement Program	SOFTWARE\ Citrix\ UserProfileManager \	REG_DWORD	CEIPEntered	0:Disable; 1:Enable;	
Enable search index roaming for Outlook	SOFTWARE\ Citrix\ UserProfileManager \	REG_DWORD	OutlookSearchRoaming	0:Disabled; 1:Enable;	

Policy Name	Key Path	Value Type	Value Name	Value Data	Value Description
Outlook search index database - backup and restore	SOFTWARE\ Citrix\ UserProfileManager \	REG_DWORD	OutlookEdbBackupEnabled	0:Disable; 1:Enable;	
Enable concurrent session support for Outlook search data roaming	SOFTWARE\ Citrix\ UserProfileManager \	REG_DWORD	OutlookSearchRoamingConcurrentSessionEnabled	0:Disable; 1:Enable;	
	SOFTWARE\ Citrix\ UserProfileManager \	REG_DWORD	OutlookOstVhdxMaximum	Maximum number of VHDX disks for storing Outlook OST files.	
Enable multi-session write-back for profile containers	SOFTWARE\ Citrix\ UserProfileManager \	REG_DWORD	FSLogixProfileContainersSupport	0:Disable; 1:Enable;	
Replicate user stores	SOFTWARE\ Citrix\ UserProfileManager \	REG_DWORD	Enabled	0:Disable; 1:Enable;	
	UserGroupConfigs \<SID>\		MultipleRemoteStoreReplication		

Policy Name	Key Path	Value Type	Value Name	Value Data	Value Description
	SOFTWARE\ Citrix\ UserProfileManager \	REG_SZ	List item	List item	
Enable credential-based access to user stores	SOFTWARE\ Citrix\ UserProfileManager \	REG_DWORD	CredBasedAccess	Disable; 1:Enable;	
Customize storage path for VHDX files	SOFTWARE\ Citrix\ UserProfileManager \	REG_SZ	PathToVhdStore	Path to store VHDX files.	
Automatically reattach VHDX disks in sessions	SOFTWARE\ Citrix\ UserProfileManager \	REG_DWORD	EnableVolumeReattach	Disable; 1:Enable;	
Enable asynchronous processing for user Group Policy on logon	SOFTWARE\ Citrix\ UserProfileManager \	REG_DWORD	SyncGpoStateEnable	Disable; 1:Enable;	

Policy Name	Key Path	Value Type	Value Name	Value Data	Value Description
Enable OneDrive container	SOFTWARE\ Citrix\ UserProfileManager \	REG_DWORD	Enabled	0:Disable; 1:Enable;	
	SOFTWARE\ Citrix\ UserProfileManager \	REG_SZ	List item	List item	
Free space ratio to trigger VHD disk compaction	SOFTWARE\ Citrix\ UserProfileManager \	REG_DWORD	CompactVHDFreeSpace	FreeSpace ratio (%).	
Number of logoffs to trigger VHD disk compaction	SOFTWARE\ Citrix\ UserProfileManager \	REG_DWORD	CompactVHDIterations	Number of logoffs.	
Disable de-fragmentation for VHD disk compaction	SOFTWARE\ Citrix\ UserProfileManager \	REG_DWORD	CompactVHDnDefrag	0:Disable; 1:Enable;	

Policy Name	Key Path	Value Type	Value Name	Value Data	Value Description
	SOFTWARE\ Citrix\ UserProfileManager \	REG_SZ	List item	List item	
	SOFTWARE\ Citrix\ UserProfileManager \	REG_SZ	List item	List item	
Folders to include in profile container	SOFTWARE\ Citrix\ UserProfileManager \	REG_DWORD	Enabled	0:Disable; 1:Enable;	
	SOFTWARE\ Citrix\ UserProfileManager \	REG_DWORD	Enabled	0:Disable; 1:Enable;	
	SOFTWARE\ Citrix\ UserProfileManager \	REG_DWORD	Enabled	0:Disable; 1:Enable;	
Files to exclude from profile container	SOFTWARE\ Citrix\ UserProfileManager \	REG_DWORD	Enabled	0:Disable; 1:Enable;	
	SOFTWARE\ Citrix\ UserProfileManager \	REG_DWORD	Enabled	0:Disable; 1:Enable;	
	SOFTWARE\ Citrix\ UserProfileManager \	REG_DWORD	Enabled	0:Disable; 1:Enable;	

Policy Name	Key Path	Value Type	Value Name	Value Data	Value Description
	SOFTWARE\ Citrix\ UserProfileManager \	REG_SZ	List item	List item	
Files to include in profile container	SOFTWARE\ Citrix\ UserProfileManager \	REG_DWORD	Enabled	0:Disable; 1:Enable;	
	SOFTWARE\ Citrix\ UserProfileManager \	REG_SZ	List item	List item	
Enable VHD disk compaction	SOFTWARE\ Citrix\ UserProfileManager \	REG_DWORD	EnableVHDCompaction	0:Disable; 1:Enable;	

Policy Name	Key Path	Value Type	Value Name	Value Data	Value Description
Exclusion list	SOFTWARE\ Citrix\ UserProfileManager \	REG_DWORD	Enabled	0:Disable; 1:Enable;	
	SOFTWARE\ Citrix\ UserProfileManager \	REG_SZ	List item	List item	
Inclusion list	SOFTWARE\ Citrix\ UserProfileManager \	REG_DWORD	Enabled	0:Disable; 1:Enable;	
	SOFTWARE\ Citrix\ UserProfileManager \	REG_SZ	List item	List item	

Policy Name	Key Path	Value Type	Value Name	Value Data	Value Description
NTUSER.DAT backup	SOFTWARE\ Citrix\ UserProfileManager \	REG_DWORD	LastKnownGoodRegistry	0:Disable; 1:Enable;	
Exclusion list - files	SOFTWARE\ Citrix\ UserProfileManager \	REG_DWORD	Enabled	0:Disable; 1:Enable;	
	SOFTWARE\ Citrix\ UserProfileManager \	REG_SZ	List item	List item	
Exclusion list - directories	SOFTWARE\ Citrix\ UserProfileManager \	REG_DWORD	Enabled	0:Disable; 1:Enable;	
	SOFTWARE\ Citrix\ UserProfileManager \	REG_DWORD	Enabled	0:Disable; 1:Enable;	

Policy Name	Key Path	Value Type	Value Name	Value Data	Value Description
	SOFTWARE\ Citrix\ UserProfileManager \	REG_SZ	List item	List item	
Logon Exclusion Check	SOFTWARE\ Citrix\ UserProfileManager \	REG_DWORD	LogonExclusionCheck	Synchronize excluded files or folders; 1:Ignore excluded files or folders; 2:Delete excluded files or folders;	
Large File Handling - Files to be created as symbolic links	SOFTWARE\ Citrix\ UserProfileManager \	REG_DWORD	Enabled	0:Disable; 1:Enable;	
	SOFTWARE\ Citrix\ UserProfileManager \	REG_SZ	List item	List item	
	SOFTWARE\ Citrix\ UserProfileManager \	REG_SZ	List item	List item	

Policy Name	Key Path	Value Type	Value Name	Value Data	Value Description
Directories to synchronize	SOFTWARE\ Citrix\ UserProfileManager \	REG_DWORD	Enabled	0:Disable; 1:Enable;	
	SOFTWARE\ Citrix\ UserProfileManager \	REG_SZ	List item	List item	
Files to synchronize	SOFTWARE\ Citrix\ UserProfileManager \	REG_DWORD	Enabled	0:Disable; 1:Enable;	
	SOFTWARE\ Citrix\ UserProfileManager \	REG_SZ	List item	List item	

Policy Name	Key Path	Value Type	Value Name	Value Data	Value Description
Folders to mirror	SOFTWARE\ Citrix\ UserProfileManager\ UserGroupConfigs\ <SID>\ MirrorFoldersList	REG_DWORD	Enabled	0:Disable; 1:Enable;	
	SOFTWARE\ Citrix\ UserProfileManager\ UserGroupConfigs\ <SID>\ MirrorFoldersList\ List	REG_SZ	List item	List item	
Accelerate folder mirroring	SOFTWARE\ Citrix\ UserProfileManager\ UserGroupConfigs\ <SID>	REG_DWORD	AccelerateFolderMirroring	0:Disable; 1:Enable;	
Profile streaming	SOFTWARE\ Citrix\ UserProfileManager\ UserGroupConfigs\ <SID>	REG_DWORD	PSEnabled	0:Disable; 1:Enable;	
Enable profile streaming for pending area	SOFTWARE\ Citrix\ UserProfileManager\ UserGroupConfigs\ <SID>	REG_DWORD	PSForPendingArea	0:Disable; 1:Enable;	

Policy Name	Key Path	Value Type	Value Name	Value Data	Value Description
Always cache	SOFTWARE\ Citrix\ UserProfileManager \	REG_DWORD	PSAlwaysCache	0:Disable; 1:Enable;	
	SOFTWARE\ Citrix\ UserProfileManager \	REG_DWORD	PSAlwaysCacheSize	Cache files this size or larger (in MB).	
Timeout for pending area lock files (days)	SOFTWARE\ Citrix\ UserProfileManager \	REG_DWORD	PSPendingLockTime	Timeout for pending area lock files (days).	
Streamed user profile groups	SOFTWARE\ Citrix\ UserProfileManager \	REG_DWORD	Enabled	0:Disable; 1:Enable;	
	SOFTWARE\ Citrix\ UserProfileManager \	REG_SZ	List item	List item	

Policy Name	Key Path	Value Type	Value Name	Value Data	Value Description
Profile Streaming Exclusion list - directories	SOFTWARE\ Citrix\ UserProfileManager \	REG_DWORD	Enabled	0:Disable; 1:Enable;	
	UserGroupConfigs \<SID>\ StreamingExclusionList				
	SOFTWARE\ Citrix\ UserProfileManager \	REG_SZ	List item	List item	
	UserGroupConfigs \<SID>\ StreamingExclusionList \List				
Enable cross-platform settings	SOFTWARE\ Citrix\ UserProfileManager \	REG_DWORD	CPEnabled	0:Disable; 1:Enable;	
	UserGroupConfigs \<SID>				
Cross-platform settings user groups	SOFTWARE\ Citrix\ UserProfileManager \	REG_DWORD	Enabled	0:Disable; 1:Enable;	
	UserGroupConfigs \<SID>\ CPUUserGroupList				

Policy Name	Key Path	Value Type	Value Name	Value Data	Value Description
	SOFTWARE\ Citrix\ UserProfileManager \ UserGroupConfigs \<SID>\ CPUTerGroupList \List	REG_SZ	List item	List item	
Path to cross- platform definitions	SOFTWARE\ Citrix\ UserProfileManager \ UserGroupConfigs \<SID>	REG_SZ	CPSchemaPath	Path to cross- platform definitions.	
Path to cross- platform settings store	SOFTWARE\ Citrix\ UserProfileManager \ UserGroupConfigs \<SID>	REG_SZ	CPPath	Path to cross- platform settings store.	
Source for creating cross- platform settings	Software\Policies\Citrix\ProfileManager	REG_DWORD	ProfileMigrationFromBaseProfileToCPStore	0:Disabled; 1:Enable;	
Enable Citrix Virtual Apps Optimization	SOFTWARE\ Citrix\ UserProfileManager \ UserGroupConfigs \<SID>	REG_DWORD	XenAppOptimization	0:Disabled; 1:Enable;	

Policy Name	Key Path	Value Type	Value Name	Value Data	Value Description
Path to Citrix Virtual Apps optimization definitions	SOFTWARE\ Citrix\ UserProfileManager \	REG_SZ	XenAppOptimizationPathDefinitionPath	Virtual Apps optimization definitions.	
Files to include in the shared store for deduplication	SOFTWARE\ Citrix\ UserProfileManager \	REG_DWORD	Enabled	0:Disable; 1:Enable;	
	UserGroupConfigs \<SID>\				
	SharedStoreFileInclusionList				
	SOFTWARE\ Citrix\ UserProfileManager \	REG_SZ	List item	List item	
	UserGroupConfigs \<SID>\				
	SharedStoreFileInclusionList \List				
Files to exclude from the shared store	SOFTWARE\ Citrix\ UserProfileManager \	REG_DWORD	Enabled	0:Disable; 1:Enable;	
	UserGroupConfigs \<SID>\				
	SharedStoreFileExclusionList				

Policy Name	Key Path	Value Type	Value Name	Value Data	Value Description
	SOFTWARE\ Citrix\ UserProfileManager \	REG_SZ	List item	List item	
	SOFTWARE\ Citrix\ UserProfileManager \	REG_SZ	UserGroupConfigs		
	SOFTWARE\ Citrix\ UserProfileManager \	REG_SZ	<SID>		
	SOFTWARE\ Citrix\ UserProfileManager \	REG_SZ	SharedStoreFileExclusionList		
	SOFTWARE\ Citrix\ UserProfileManager \	REG_SZ	List		
Enable VHD auto-expansion for profile container	SOFTWARE\ Citrix\ UserProfileManager \	REG_DWORD	Enabled	0:Disable; 1:Enable;	
Profile container auto-expansion threshold	SOFTWARE\ Citrix\ UserProfileManager \	REG_DWORD	AutoExtendThres	Auto-expansion threshold (percent)	
Profile container auto-expansion increment	SOFTWARE\ Citrix\ UserProfileManager \	REG_DWORD	AutoExtendSize	Auto-expansion increment (in GB)	
Profile container auto-expansion limit	SOFTWARE\ Citrix\ UserProfileManager \	REG_DWORD	AutoExtendLimit	Auto-expansion limit (in GB)	

Policy Name	Key Path	Value Type	Value Name	Value Data	Value Description
Default capacity of VHD containers	SOFTWARE\ Citrix\ UserProfileManager \	REG_DWORD	VhdCapacity	Default capacity (in GB)	
Enable exclusive access to VHD containers	SOFTWARE\ Citrix\ UserProfileManager \	REG_DWORD	DisableConcurrentAccessToProfileContainer	0:Disable; 1:Enable;	Profile container
	SOFTWARE\ Citrix\ UserProfileManager \	REG_DWORD	DisableConcurrentAccessToOneDriveContainer	0:Disable; 1:Enable;	OneDrive container
UWP app roaming	SOFTWARE\ Citrix\ UserProfileManager \	REG_DWORD	EnableUwpAppsRoaming	0:Disable; 1:Enable;	
	SOFTWARE\ Citrix\ UserProfileManager \	REG_DWORD	EnableUwpAppsRoaming	0:Disable; 1:Enable;	

Enable support for Azure AD joined and non-domain-joined VDA machines

August 6, 2024

Citrix Profile Management can now provide profile management for Azure AD joined and non-domain-joined VDA machines in a customer-managed Azure subscription.

Prerequisites

- Profile Management 2203 or later
- VDA version 2203 or later
- If Workspace Environment Management (WEM) is used to store the profile storage server's credentials, WEM agent version 2109.2.0.1 or later

Enable Profile Management

To enable Profile Management on Azure AD joined or non-domain-joined VDA machines, complete the following settings:

1. On **Profile Management**, Set the **Enable Profile management** policy to **enabled**.
2. Set the **Path to user store** policy to a valid path that is accessible to your VDA. For example, a user store is accessible when it resides on a file server or an Azure Files share.
3. Set the **Profile container** policy to **Enable**, and then add an asterisk (*) to the profile container list. For more information, see [Enable the profile container for the entire user profile](#).
4. Set the **Enable credential-based access to user stores** policy to **Enabled**. Next, save the profile storage server's credentials in WEM or Windows Credential Manager so that Profile Management can access user stores. For more information, see [Enable credential-based access to user stores](#).

Enable credential-based access to user stores

August 6, 2024

By default, Citrix Profile Management impersonates the current user to access the user store. This behavior requires the current user to have permission to directly access the user store. By contrast, the **Enable credential-based access to user stores** policy lets Profile Management access the user store using the store's own credentials.

This policy gives you more flexibility in deploying and accessing the user store. For example, this policy lets you deploy the user store on a file share that the current user doesn't have permission to access, such as Azure Files. Or, you can enable this policy if you don't want Profile Management to impersonate the current user when accessing user stores.

Note:

Profile Management provides two types of profile solutions, and the user store can serve as the storage location for both of them:

- File-based solution. User profiles are fetched from the remote user store to the local computer on logon and written back on logoff.
- Container-based solution. User profiles are stored in VHDX files (known as profile containers). Those VHDX files are attached on logon and detached on logoff.

This policy is available both for the file-based and container-based solutions. For Profile Management versions earlier than 2212, this policy is available only for the container-based solution.

For more information about creating secure user stores, see [Create a file share for roaming user profiles](#) on the Microsoft TechNet website.

To let Profile Management access the user store by using the store's own credentials, you must perform both of the following actions:

- Enable the **Enable credential-based access to user stores** policy on each machine where Profile Management runs.
- Add the store's credentials to those machines.

You can use one of the following ways to achieve that goal: Workspace Environment Management (WEM) service and GPOs.

Note:

With the container-based solution enabled, NTFS permissions are retained for the user store.

Enable credential-based access using the WEM service

Using WEM eliminates the need to enter the same credentials for each machine where Profile Management runs. You enable the policy and enter the credentials for the user store only once in the WEM service console. The WEM service then applies these settings to each machine.

Detailed steps are as follows:

1. In the administration console, go to **Policies and Profiles > Citrix Profile Management Settings > User Store Credentials**.
2. On the **User Store Credentials** tab, select the **Enable credential-based access to user store** check box.

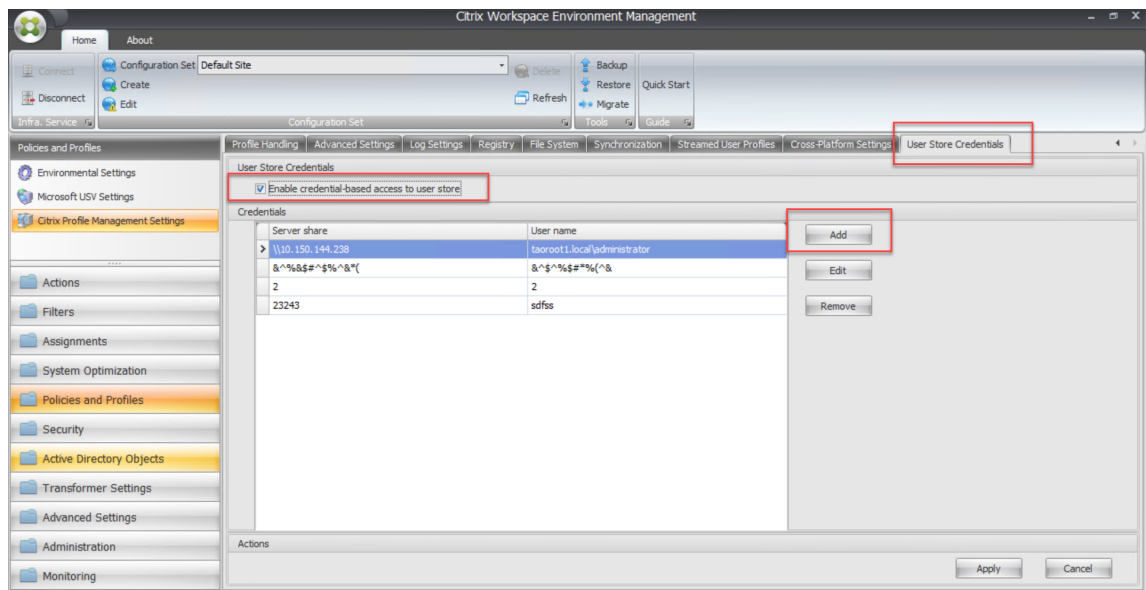

3. Click **Add**. The **New Credential** dialog box appears.

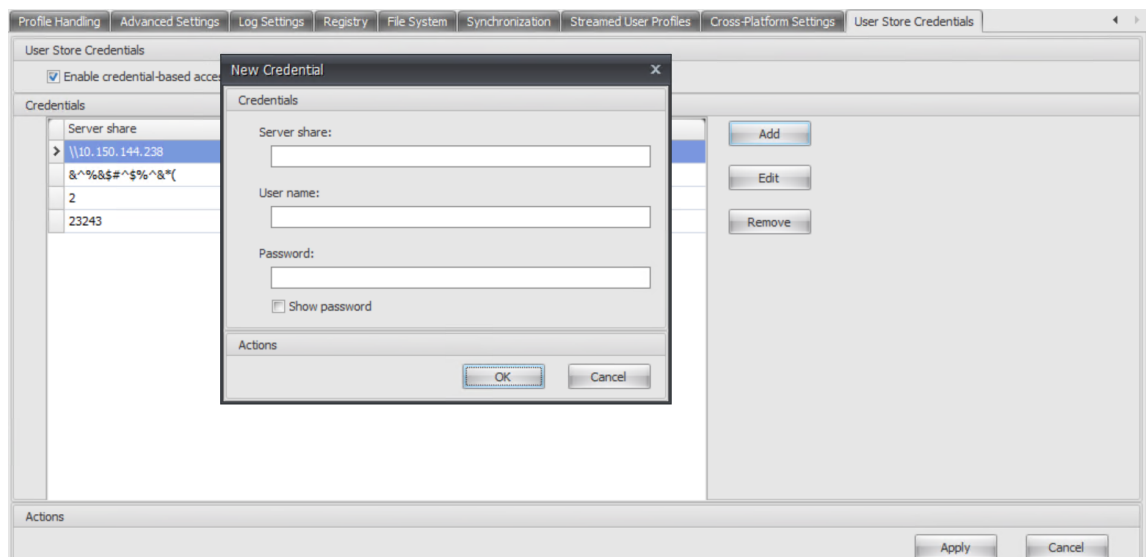

4. Type the FQDN or IP address of your profile storage server and its credentials.

5. Click **OK**.

Enable credential-based access using GPOs

When you choose to enable the policy using GPOs, you must manually add the credentials on each machine where Profile Management runs.

Enable the policy

Detailed steps are as follows:

1. Open the Group Policy Management Editor.
2. Access **Policies > Administrative Templates: Policy definitions (ADMX files) > Citrix Components > Profile Management > Advanced settings**, and then double-click **Enable credential-based access to user stores**.
3. Select **Enabled**.
4. Click **OK**.

Add the credentials to Windows Credential Manager

Profile Management uses the credentials saved on the machine to access the user store. Add the credentials for the user store to **Windows Credential Manager** on each machine where Profile Management runs. Detailed steps are as follows:

1. Download **PsExec** from the Sysinternals website and unzip files to `C:\PSTools`.
2. From the **Start** menu, right-click **Command Prompt** and select **Run as administrator**. A command shell starts.
3. Run the `C:\PSTools\PsExec -s -i cmd` command. Another command shell starts.

Note:

The `-s` parameter indicates you're running the tool using the Local System account. As a result, the credentials can be securely saved.

4. In the new command shell, run the `rundll32.exe keymgr.dll, KRShowKeyMgr` command. The **Stored User Names and Passwords** dialog box appears.
5. In the **Stored User Names and Passwords** dialog box, click **Add**.
6. Type the FQDN or IP address of your profile storage server and its credentials, leave the default credential type as is, and then click **OK**.

Enable large file handling

August 6, 2024

Large files existing in a profile are a common reason for a slow logon or logoff. Citrix provides an option to redirect large files to the user store. This option eliminates the need to synchronize those files over the network.

To enable large file handling in group policy, do the following:

1. Under **Profile Management**, open the **File system** folder.
2. Double-click the **Large File Handling - Files to be created as symbolic links** policy.
3. Specify files to be handled.

To enable large file handling in the UPMPolicyDefaults_all.ini file, do the following:

1. Add the [**LargeFileHandlingList**] section in the .ini file.
2. Specify files to be handled under that section.

You can use wildcards in policies that refer to files. For example,
!ctx_localappdata!\Microsoft\Outlook*.ost

Make sure that these files are not added to the exclusion list from Citrix Profile Management.

Note

Some applications do not allow concurrent file access. Citrix recommends that you take application behavior into consideration when you define your large file handling policy.

Citrix recommends that you apply Microsoft security update [MS15-090](#). As a general security practice, make sure that you keep your Microsoft Windows systems updated.

Enable file deduplication

August 6, 2024

Identical files can exist in various user profiles in the user store. Having duplicate instances of files stored in the user store increases your storage cost.

File deduplication policies let Profile Management remove duplicate files from the user store and store one instance of them in a central location (called *shared store*). Doing so avoids file duplication in the user store, thus reducing your storage cost. The deduplication is applied to the user store and each replicated user store.

To enable file deduplication and specify files to include in the shared store, configure the following policies:

1. **File deduplication > Files to include in the shared store for deduplication**
2. (Optional) **File deduplication > Files to exclude from the shared store**
3. (Optional) **File deduplication > Minimum size of files to deduplicate from profile containers**

Note:

Starting with 2311, file deduplication policies also apply to profile containers. To ensure the optimal user logon experience, Profile Management deduplicates a maximum of 10 files from profile containers (although you can define more than 10 files in the **Files to include in the shared store for deduplication** policy). Deduplication occurs when a listed file is updated or created and exceeds the specified size, as long as there are fewer than 10 deduplicated files.

After you configure file deduplication policies, Profile Management creates the shared store in the same path as the user store. For example,

- Path to the user store: `\\server\profiles$\%USERDOMAIN%\%USERNAME%\!CTX_OSNAME!!CTX_OSBITNESS!`
- Path to the shared store: `\\server\profiles$\%USERDOMAIN%\SharedFilesStore`

Include files in the shared store for deduplication

If duplicated files exist in the user store, enable file deduplication and specify files to include in the shared store for deduplication.

Important:

Since all files deduplicated into the shared store can be read by all domain users, we recommend against deduplicating personal and sensitive data.

Detailed steps are as follows:

1. Open the Group Policy Management Editor.
2. Access **Policies > Administrative Templates: Policy definitions (ADMX files) > Citrix Components > Profile Management > File deduplication**.
3. Double-click **Files to include in the shared store for deduplication**.
4. Select **Enabled**.
5. In the **List of files to include in the shared store** field, click **Show**.
6. Enter the file names with paths relative to the user profile.

Wildcards are supported with the following considerations:

- Wildcards in file names are applied recursively. To restrict them only to the current folder, use the vertical bar (|).

- Wildcards in folder names are not applied recursively.

Examples:

- `Downloads\profilemgt_x64.msi` —The profilemgt_x64.msi file in the Downloads folder
- `*.cfg` —Files with the .cfg extension in the user profile folder and its subfolders
- `Music*` —Files in the Music folder and its subfolders
- `Downloads*.iso` —Files with the .iso extension in the Downloads folder and its subfolders
- `Downloads*.iso|` —Files with the .iso extension only in the Downloads folder
- `AppData\Local\Microsoft\OneDrive**.dll` —Files with the .dll extension in any immediate subfolder of the AppData\Local\Microsoft\OneDrive folder

7. Click **OK** and **OK** again.

Configuration precedence

1. If this setting is disabled, the shared store is disabled.
2. If this setting isn't configured here, the value from the .ini file is used.
3. If this setting is not configured either here or in the .ini file, the shared store is disabled.

Exclude files from the shared store

Wildcard characters let you include a group of files in the shared store all at once. To exclude some files from the group, enable and configure the **Files to exclude from the shared store** policy as follows:

1. Open the Group Policy Management Editor.
2. Access **Policies > Administrative Templates: Policy definitions (ADMX files) > Citrix Components > Profile Management > File deduplication**.
3. Double-click **Files to exclude from the shared store**.
4. Select **Enabled**.
5. In the **List of files to exclude from the shared store** field, click **Show**.
6. Enter the file names with paths relative to the user profile.

Wildcards are supported with the following considerations:

- Wildcards in file names are applied recursively. To restrict them only to the current folder, use the vertical bar (|).
- Wildcards in folder names are not applied recursively.

Examples:

- `Downloads\profilemgt_x64.msi` —The profilemgt_x64.msi file in the Downloads folder
- `*.tmp` —Files with the .tmp extension in the user profile folder and its subfolders
- `AppData*.tmp` —Files with the .tmp extension in the AppData folder and its subfolders
- `AppData*.tmp|` —Files with the .tmp extension only in the AppData folder
- `Downloads*\a.txt` —The a.txt file in any immediate subfolder of the Downloads folder

7. Click **OK** and **OK** again.

Configuration precedence

1. If this setting is disabled, no files are excluded.
2. If this setting isn't configured here, the value from the .ini file is used.
3. If this setting is not configured either here or in the .ini file, no files are excluded.

Specify the minimum size of files to deduplicate from profile containers

When profile containers are enabled, you can specify the minimum size of files to deduplicate from profile containers. By default, Profile Management deduplicates files from profile containers only when they exceed 256 MB. If necessary, you can increase this threshold size using these steps:

1. Open the Group Policy Management Editor.
2. Access **Policies > Administrative Templates: Policy definitions (ADMX files) > Citrix Components > Profile Management > File deduplication**.
3. Double-click **Minimum size of files to deduplicate from profile containers**.
4. Select **Enabled**.
5. In the **Minimum size in megabytes** field, enter a value greater than 256 as needed.
6. Click **OK**.

Configuration precedence

1. If this setting is not configured here, the value from the .ini file is used.
2. If this setting is not configured either here or in the .ini file, the value is 256.

Configure shared store security settings

If no shared store exists, Profile Management automatically creates one with the following permission settings:

- Domain computers: Full control access
- Domain users: Read access

Since the default settings grant full control access to domain computers, we recommend you manually create the shared store and implement credential-based access for improved security. To do so, follow these steps:

1. Create the shared store folder at the same directory level as the %USERNAME% parameter in the **Path to user store** setting. For example, the **Path to user store** setting is \\SERVER\UPM_USER_STORE\%\%USERNAME%.%USERDOMAIN%\!CTX_OSNAME!!CTX_OSBITNESS!, then the shared store folder must be \\SERVER\UPM_USER_STORE\SharedStore.
2. Grant the following permissions for the shared store. As shown in this figure, the user SharedStoreManagementUser is the credential used to access the shared store.

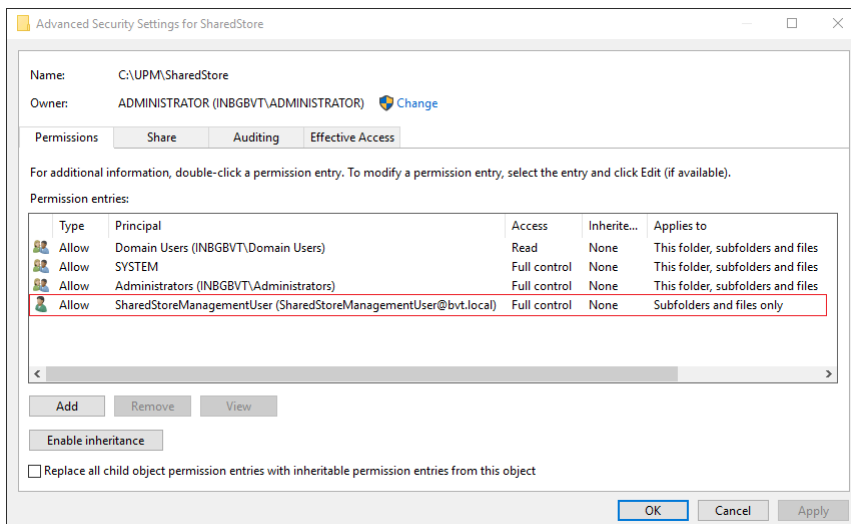

3. On each VDA, add Windows credentials for the SharedStoreManagementUser user account to access the shared store. You can use Windows Credential Manager or Workspace Environment Management for this purpose. See the procedures described in [Enable credential-based access to user stores](#) for details.

Enable native Outlook search experience

August 6, 2024

The **Enable search index roaming for Outlook** feature provides native Outlook search experience. With this feature, the Offline Outlook Data File (.ost) and the search database specific to a user are roamed along with the user profile.

Prerequisites

This feature is available for machines that meet the following requirements:

- Operating system:
 - Microsoft Windows 10 1709 or later
 - Windows Server 2016 or later
- Microsoft Outlook 2019, 2016, or 2103, or Microsoft Office 365

For the feature to take effect, make sure that machines have the Microsoft Windows Search Service enabled. By default, it's enabled on Windows desktops and disabled on Windows servers. For more information about how to enable the service on Windows servers, see this [Microsoft article](#). The following versions have been tested and are supported:

- 7.0.20348.380, 7.0.20348.138, 7.0.20344.1
- 7.0.21286.1000, 7.0.21343.1000
- 7.0.17134.376, 7.0.17134.285, 7.0.17134.228, 7.0.17134.1
- 7.0.16299.402, 7.0.16299.248, 7.0.16299.15
- 7.0.15063.413
- 7.0.14393.2457, 7.0.14393.2430, 7.0.14393.2368, 7.0.14393.2312, 7.0.14393.2273, 7.0.14393.2248, 7.0.14393.1884, 7.0.1493.1593
- 7.0.1393.2125, 7.0.1393.1884, 7.0.1393.1770
- 7.0.10240.17443
- 7.0.9600.18722

Note:

This feature is expected to support the future versions of the Microsoft Windows Search Service. If you find that the feature does not support specific future versions of the Microsoft Windows Search Service, contact Citrix Technical Support.

How it works

The VHDX (Virtual Hard Disk) is a disk file format that is used to represent virtual and logical disk storage space for virtual machines. The Enable search index roaming for Outlook feature relies on VHDX files to work.

VHDX files are created for each user that uses the feature. VHDX files store a user-specific profile on a separate virtual disk that is dedicated to that user's profile. Profile Management mounts VHDX files on logon and unmounts them on logoff. There are two VHDX files:

- OutlookOST.vhdx file, storing the Offline Outlook Data File (.ost)
- OutlookSearchIndex.vhdx file, storing the search index database for the offline folder file stored in the OutlookOST.vhdx file

Note:

By default, Profile Management automatically reattaches VHDX files that are detached during a session. For more information, see [Automatically reattach detached VHDX disks in sessions](#).

Profile Management provides a default VHDX capacity of 30 GB. Plan your storage quota accordingly. If the actual usage of your VHDX exceeds the quota you configured earlier, your VHDX file is unmounted.

Automatic switching between Cached Exchange mode and Online mode

Profile Management provides an uninterrupted Outlook service on Outlook container-enabled machines:

- When detecting that all conditions for Outlook container to work are met on user logon, Profile Management automatically enables Cached Exchange mode for Outlook. With Cached Exchange mode enabled, users are linked to their Outlook containers for mailbox data. Those conditions include:
 - The Enable search index roaming for Outlook policy is enabled.
 - The Outlook container is attached.
 - The customized OST path is not set or set to `appdata\local\microsoft\outlook`, the mounting path of Outlook container.
- When detecting that the container is detached during the session, Profile Management switches Outlook from Cached Exchange mode to Online mode. Users are linked to the Exchange Server for mailbox data.
- When detecting that the container is reattached during the session, Profile Management switches Outlook back to Cached Exchange mode.

Support for concurrent sessions

With the **Enable concurrent session support for Outlook search data roaming** feature, Profile Management provides the native Outlook search experience in concurrent sessions of the same user.

The feature assigns a copy of the Outlook OST file to each concurrent session of a user. By default, Profile Management provides two VHDX disks to store Outlook OST files (one file per disk). If the user starts more sessions, the additional Outlook OST files are stored in the local profile.

If you have storage capacity available, you can increase the default number of the VHDX disks. For example, set the number to 3. As a result, Profile Management stores the OST files for the first three sessions on VHDX disks and those OST files for any subsequent sessions in the local profile.

Automatic backup and restore of Outlook search index database

Profile Management can automatically save a backup of the last known good copy of the search index database and revert to the copy if corruption occurs.

If this feature is enabled, Profile Management saves a backup of the search index database each time the database is mounted successfully on logon. Profile Management deletes the previously saved backup after a new backup is saved successfully. Profile Management treats the backup as the good copy of the search index database. When an attempt to mount the search index database fails, Profile Management automatically reverts the search index database to the last known good copy.

Important:

- Profile Management does not save a backup of the search index database after the policy takes effect the first time the search index database is created.
- Profile Management deletes the previously saved backup after a new backup is saved successfully. The backup consumes more of the available storage space of the VHDX files.

Enable the feature

To provide native Outlook search experience, enable the **Enable search index roaming for Outlook** feature and enable its enhancements if needed. Detailed steps are as follows.

1. Open the Group Policy Management Editor.
2. Access **Policies > Administrative Templates: Policy definitions (ADMX files) > Citrix Components > Profile Management > Advanced settings**.
3. Enable the feature using the following steps:
 - a) Double-click the **Enable search index roaming for Outlook** policy.
 - b) Select **Enabled**.
 - c) Click **OK**.
4. To support the feature in concurrent sessions of the same user, follow these steps:
 - a) Double-click the **Enable concurrent session support for Outlook search data roaming** policy.
 - b) Select **Enabled**.

- c) If you have storage capacity available, increase the number of the default VHDX disks in the **Maximum number of VHDX disks for storing Outlook OST files** field. For more information about this field, see Support for concurrent sessions.
 - d) Click **OK**.
5. To provide a high level of stability for the feature, follow these steps:
 - a) Double-click the **Outlook search index database-backup and restore** policy.
 - b) Select **Enabled**.
 - c) Click **OK**.
6. To provide a high level of availability for the feature, follow these steps:
 - a) Double-click the **Automatically reattach VHDX disks in sessions** policy.
 - b) Select **Enabled**.
 - c) Click **OK**.

For your changes to take effect, run the `gpupdate /force` command from the command prompt, log off from all sessions, and then log on again. For details, see <https://docs.microsoft.com/en-us/windows-server/administration/windows-commands/gpupdate>.

Note:

To let this feature work on Microsoft Windows 10 1809 and later, and on Windows Server 2019 and later, add a DWORD value `EnablePerUserCatalog = 0` under `HKEY_LOCAL_MACHINE\SOFTWARE\Microsoft\Windows Search`. Restart the VDA to make your registry setting take effect.

Enable the OneDrive container

September 10, 2024

With the OneDrive container, OneDrive folders can roam with users. As a result, a user can access the same OneDrive folders on any computer.

The OneDrive container is a VHDX-based folder roaming solution. Profile Management creates a VHDX file per user on a file share and stores the users' OneDrive folders into the VHDX files. The VHDX files are attached when users log on and detached when users log off.

Profile Management provides the following two profile solutions, and the OneDrive container applies to both of them:

- **File-based.** User profiles are fetched from the remote user store to the local computer on logon and written back on logoff.

- **Container-based.** User profiles are stored in VHDX files (known as profile containers). Those VHDX files are automatically attached on logon and detached on logoff.

The general workflow for deploying the OneDrive container is as follows:

1. (Optional) specify the storage path for the VHDX files
2. Enable and configure the OneDrive container

Note:

- Starting with Citrix Profile Management 2206, if you use the container-based solution, OneDrive folders roam with users by default. However, if you want to roam OneDrive folders using a separate container, you can also enable the OneDrive container.
- Starting with Citrix Profile Management 2311, OneDrive container supports the following sync features:
 - Multi-session runtime sync. Any changes a user makes to the OneDrive files in one session are now instantly visible in all concurrent sessions.
 - Single Sign-On (SSO) sync. Users don't need to reenter credentials for OneDrive during subsequent logons.

(Optional) specify the storage path for the VHDX files

By default, the VHDX files for the OneDrive container are stored on the same storage server as the user store.

For example, you configure the path of the user store as

```
\\myprofileserver\profiles$\%username%.%domain%\!ctx_osname!..!  
ctx_osbitness!
```

The VHDX files for the OneDrive container are then stored in

```
\\myprofileserver\profiles$\%username%.%domain%\!ctx_osname!..!  
ctx_osbitness!\OneDrive
```

If needed, you can specify a different file share to store VHDX disks for OneDrive folders. For more information, see [Specify the storage path for VHDX files](#).

Enable and configure the OneDrive container

Enable the OneDrive container policy and specify the OneDrive folders to store in the VHDX files. Detailed steps are as follows:

1. Open the Group Policy Management Editor.

2. Access **Policies > Administrative Templates: Policy definitions (ADMX files) > Citrix Components > Profile Management > Advanced settings**, and then double-click **Enable OneDrive container**.
3. Select **Enabled**.
4. In the **List of OneDrive folders** field, click **Show**.
5. Enter your OneDrive folders in the form of the path relative to the user profile, and then click **OK**.

For example, if the absolute path of your OneDrive folder is %userprofile%\OneDrive - Citrix, add `OneDrive - Citrix` to the list.

Note:

The relative paths cannot include any variables, such as `!CTX_OSNAME!` and `!CTX_OSBITNESS!`.

6. Click **OK**.

Enable UWP app roaming (preview)

August 12, 2024

With the **Enable UWP apps roaming** policy, you can let UWP (Universal Windows Platform) apps roam with users. As a result, users can access the same UWP apps from different devices.

Note:

- This policy is compatible only with Windows 10 and is incompatible with other Windows versions or Windows Server versions.
- The **Replicate user store** policy doesn't support VHDX disk replication for UWP apps.

How it works

When the **Enable UWP apps roaming** policy is enabled, Profile Management operates as follows:

1. When a user starts the installation of a UWP app, Profile Management monitors the installation process.
2. If it's the initial installation of the app in your environment, Profile Management creates a VHDX disk in the `{ User_Store_File_Share_Path } \AppStore\` folder (referred to as *UWP app container*) and stores the app (except personal settings) in that disk. For subsequent

installation of the same app, Profile Management doesn't create an additional VHDX disk. Thus, each UWP app has a single VHDX disk within the UWP app container.

3. Upon user logon to a machine, VHDX disks of the UWP apps installed by the user are attached. Upon user logoff, those disks are detached.

Important:

- UWP app roaming applies only to UWP apps installed using per-user packages after the policy is enabled. In other words, if the policy is enabled after an app is installed, the app won't benefit from roaming until it's reinstalled using a per-user package.
- All users share UWP VHDX disks.

Enable the UWP app roaming policy using a GPO

Detailed steps are as follows:

1. Open the Group Policy Management Editor.
2. Access **Policies > Administrative Templates: Policy definitions (ADMX files) > Citrix Components > Profile Management > Advanced settings**.
3. Double-click the **UWP apps roaming** policy.
4. In the policy window that appears, select **Enabled**, and then click **OK**.
5. To provide a better logon and logoff experience for UWP roaming, enable the **Accelerate folder mirroring** policy as follows:
 - a) Access **Policies > Administrative Templates: Policy definitions (ADMX files) > Citrix Components > Profile Management > File system > Synchronization**.
 - b) Double-click the **Accelerate folder mirroring** policy.
 - c) In the policy window that appears, select **Enabled**, and then click **OK**.

The configuration precedence is as follows:

- If this setting isn't configured using a GPO, Studio, or Workspace Experience Management (WEM), the value from the .ini file is used.
- If this setting isn't configured anywhere, this feature is disabled.

For your changes to take effect, run the `gpupdate /force` command from the command prompt as documented at <https://docs.microsoft.com/en-us/windows-server/administration/windows-commands/gpupdate>.

Configure VHD settings

August 26, 2024

This article shows you how to customize and optimize VHDX-based features:

- Specify the storage capacity and path for VHD containers
Applies to: profile containers, OneDrive containers, folder mirroring containers, and Outlook search index containers.
- Enable and configure VHD disk compaction settings
Applies to: profile containers, OneDrive containers, and folder mirroring containers
- Enable exclusive access to VHD containers
Applies to: profile containers and OneDrive containers
- Enable automatic reattachment of VHDX disks in sessions
Applies to: profile containers, Outlook search index containers, folder mirroring containers, and OneDrive containers.

For more information about these containers see:

- [Profile container](#)
- [Outlook search index roaming](#) (called *Outlook search index container*)
- [Accelerating folder mirroring solution](#) (called *folder mirroring container*)
- [OneDrive container](#)

Specify the storage capacity and path for VHD containers

By default, each VHDX container is stored in the user store with a disk capacity of 50 GB. If needed, you can choose a different storage path for it and change its default capacity.

The following lists the default and custom storage paths of VHDX files:

- Profile container settings
 - Default: {USER_STORE_PATH}\ProfileContainer\{OS_NAME_SHORT}\
 - Custom: {VHDX_STORE_PATH}\ProfileContainer\{OS_NAME_SHORT}\
- Outlook search index roaming
 - Default: {USER_STORE_PATH}\VHD\{OS_NAME_SHORT}\

- Custom: {VHDX_STORE_PATH}\VHD\{OS_NAME_SHORT}\
- Accelerate folder mirroring
 - Default: {USER_STORE_PATH}\MirrorFolders\
 - Custom: {VHDX_STORE_PATH}\MirrorFolders\
- Enable OneDrive container
 - Default: {USER_STORE_PATH}\OneDrive\
 - Custom: {VHDX_STORE_PATH}\OneDrive\

Profile Management now impersonates the current user to access the VHDX files and does not grant Domain Computers `full control` permission to the storage path of the VHDX files.

Specify the storage path

Prepare a network storage location for the VHDX containers. Make sure that you grant your users `Modify` permission or higher to the storage location.

Specify the storage path for VHDX containers by following these steps:

1. Open the **Group Policy Management Editor**.
2. Under **Computer Configuration > Administrative Templates > Citrix Components > Profile Management > Advanced settings**, double-click the **Customize storage path for VHDX files** policy.
3. Select **Enabled**.
4. In the **Path to store VHDX files** field, type the full path of the storage location. Example: `\\myservername\vhd_x_store`.
5. Click **Apply**, and then click **OK**.

To enable the setting to take effect, do the following:

1. Log off from all sessions that are using the user profile.
2. Run the `gpupdate /force` command from the command prompt.

When the policy takes effect varies depending on the use cases:

- If it is the first time you specify a storage path for VHDX files, the policy takes effect after the user logs on.
- If it is you change the storage path for VHDX files, the policy takes effect after the user logs off for the first time.

For more information about the `gpupdate` command, see the [Microsoft document](#).

If this setting is not configured here, the value from the .ini file is used. If this setting is not configured here or in the .ini file, Profile Management stores the VHDX files in the user store.

Specify the default storage capacity for a VHD container

Each VHD container has a default storage capacity of 50 GB. To change the capacity, follow these steps:

1. Open the **Group Policy Management Editor**.
2. Under **Computer Configuration > Administrative Templates > Citrix Components > Profile Management > Advanced settings**, double-click the **Default capacity of VHD containers (GB)** policy.
3. Select **Enabled**.
4. In the **Default capacity (in GB)** field, type a new number as needed.
5. Click **OK**.

Enable and configure VHD disk compaction settings

VHD disk compaction is a process that reduces the size of a VHD file by removing empty space and combining the data within the file. With the **Enable VHD disk compaction** policy, you can enable VHD disk compaction for Profile Management. VHD files created by Profile Management are automatically compacted on user logoff when certain conditions are met, thus saving space on central or cloud storage.

This section guides you through enabling VHD disk compaction and adjusting the default compaction settings and behavior.

Overview

VHDX disk compaction applies to the following VHDX files in Profile Management:

- [Profile container](#)
- [OneDrive container](#)
- [Folder mirroring container](#)

With the **Enable VHD disk compaction** policy enabled, a VHDX file is automatically compacted on user logoff when one of the following conditions is met:

- The free space ratio of the VHD file exceeds a specified value (by default, 20%)

Free space ratio = (current VHD file size – required minimum VHD file size*) ÷ current VHD file size

* Obtained using the `GetSupportedSize` method of the `MSFT_Partition` class from the Microsoft Windows operating system. See [Get the required minimum size for a VHD file](#) for details.

- The number of logoffs since the last compaction reaches a specified value (by default, 5)

Note:

When a user logs off, the process of compacting VHD disks occurs in parallel with the logoff process. Thus, disk compaction does not prolong logoff time. If the VHD disk compaction process is not complete when the user attempts to log back on, Profile Management prevents the logon attempt.

Depending on your needs and the resources available, you can adjust those default settings using the following policies in **Advanced settings**:

- Free space ratio to trigger VHD disk compaction
- Number of logoffs to trigger VHD disk compaction

When VHD disk compaction is enabled, the VHD disk file is first defragmented using the Windows built-in `defrag` tool, and then compacted. VHD disk defragmentation produces better compaction results while disabling it can save system resources. If needed, you can disable defragmentation using the following policy in **Advanced settings**:

- Disable defragmentation for VHD disk compaction

Enable VHD disk compaction

With VHD disk compaction enabled, you can save storage space consumed by profile container, OneDrive container, and folder mirroring container.

To enable VHD disk compaction using a GPO, follow these steps:

1. Open the Group Policy Management Editor.
2. Access **Policies > Administrative Templates: Policy definitions (ADMX files) > Citrix Components > Profile Management > Profile Container settings**.
3. Double-click the **VHD disk compaction** policy.
4. In the policy window that appears, select **Enabled**, and then click **OK**.

The configuration precedence is as follows:

1. If this setting isn't configured using a GPO, Studio, or Workspace Environment Management (WEM), the value from the .ini file is used.
2. If this setting isn't configured anywhere, the feature is disabled.

Change the compaction settings and behavior

Enabling VHD disk compaction can save storage space, but it also consumes system I/O and network bandwidth. You can monitor the system and network resource usage during the compaction process to determine whether to adjust the following settings:

- Free space ratio to trigger VHD disk compaction
- Number of logoffs to trigger VHD disk compaction
- Disable defragmentation for VHD disk compaction

To change the default compaction settings and behavior using a GPO, follow these steps:

1. Open the Group Policy Management Editor.
2. Access **Policies > Administrative Templates: Policy definitions (ADMX files) > Citrix Components > Profile Management > Advanced settings**.
3. To change the free space ratio to trigger the compaction, follow these steps:
 - a) Double-click the **Free space ratio to trigger VHD disk compaction** policy.
 - b) In the policy window that appears, select **Enabled**, enter a percentage as needed, and then click **OK**.
4. To change the number of logoffs (since the last compact) to trigger the compaction, follow these steps:
 - a) Double-click the **Number of logoffs to trigger VHD disk compaction** policy.
 - b) In the policy window that appears, select **Enabled**, enter a value as needed, and then click **OK**.
5. To disable defragmentation for VHD disk compaction, follow these steps:
 - a) Double-click the **Disable defragmentation for VHD disk compaction** policy.
 - b) In the policy window that appears, select **Enabled**, and then click **OK**.

The configuration precedence is as follows:

- Free space ratio to trigger VHD disk compaction
 1. If this setting isn't configured using a GPO, Studio, or WEM, the value from the .ini file is used.
 2. If this setting isn't configured anywhere, the default value 20 (%) is used.
- Number of logoffs to trigger VHD disk compaction
 1. If this setting isn't configured using a GPO, Studio, or WEM, the value from the .ini file is used.
 2. If this setting isn't configured anywhere, the default value 5 is used.
- Disable defragmentation for VHD disk compaction
 1. If this setting isn't configured using a GPO, Studio, or WEM, the value from the .ini file is used.
 2. If this setting isn't configured anywhere, defragmentation is enabled by default.

Get the required minimum size for a VHD file

Detailed steps are as follows:

1. Ensure that the VHD file is attached to the operating system.
2. Run this PowerShell command as an administrator:

```
Get-WmiObject -Class MSFT_Partition -Namespace ROOT\Microsoft\Windows\Storage
```

All partitions of your current desktop appear.

3. Locate the partition corresponding to the VHD file, and then get the required minimum size (`SizeMin`) using the `GetSupportedSize` method.

Enable exclusive access to VHD containers

Note:

- This setting applies to OneDrive containers and the profile containers that are enabled for the entire user profile.
- If this setting is enabled for profile containers, the **Enable multi-session write-back for profile containers** setting is automatically disabled.

By default, VHD containers allow concurrent access. If needed, you can disable concurrent access for profile containers and OneDrive containers.

Detailed steps are as follows:

1. Open the **Group Policy Management Editor**.
2. Under **Computer Configuration > Administrative Templates > Citrix Components > Profile Management > Profile container settings**, double-click the **Enable exclusive access to VHD containers** policy.
3. Select **Enabled**.
4. Select the containers to which you want to enable exclusive access. Options include **Profile container** and **OneDrive container**.
5. Click **OK**.

To enable the setting to take effect, do the following:

1. Log off from all sessions that are using the user profile.
2. Run the `gpupdate /force` command from the command prompt.

If this policy is not configured here, the value from the .ini file is used. If this policy is not configured either here or in the .ini file, the setting is disabled.

Enable automatic reattachment of VHDX disks in sessions

With the **Automatically reattach VHDX disks in sessions** feature, Profile Management ensures a high level of stability of VHDX-based policies.

Each VHDX-related policy relies on the relevant VHDX disk to function properly. Profile Management attaches those disks during logons and detaches them during logoffs. However, those VHDX disks might be accidentally detached during a session, preventing the policies from functioning properly. Possible causes for a VHDX disk to be detached include:

- File server encountering a transient error
- Slow network connection

With the **Automatically reattach VHDX disks in sessions** policy enabled, Profile Management monitors VHDX disks that are in use by the preceding VHDX-based policies. If any of the disks is detached, Profile Management reattaches the disk automatically.

Enable the policy

By default, the policy is enabled. We recommend you keep its default setting to ensure the high stability of VHDX-based policies.

If you experience performance issues with the VHDX-based policies, follow these steps to check the policy setting:

1. Open the Group Policy Management Editor.
2. Under **Citrix Components > Profile Management > Advanced settings**, double-click the **Automatically reattach VHDX disks in sessions** policy.
3. If the setting is **Disabled**, select **Enabled**, and then click **OK**.

For your changes to take effect, run the `gpupdate /force` command from the command prompt, as documented in the [Microsoft article](#).

Configuration precedence:

1. If this policy isn't configured here, the value from the .ini file is used, which defaults to **enabled**.
2. If this setting is not configured either here or in the .ini file, the policy is enabled by default.

Resolve conflicting profiles

August 6, 2024

Conflicts between local Windows user profiles and Citrix user profiles (in the user store) can occur when you add Profile Management to an existing deployment. In this scenario, you must determine how the data in the local Windows profile is managed.

1. Under Profile Management, open the Profile handling folder.
2. Double-click the **Local profile conflict handling** policy.
3. Select **Enabled**.
4. Select one of the following options from the drop-down list:
 - **Use local profile.** Profile Management processes the local Windows user profile but does not change it in any way.
 - **Delete local profile.** Profile Management deletes the local Windows user profile and then imports the Citrix user profile from the user store.
 - **Rename local profile.** Profile Management renames the local Windows user profile (for backup purposes) and then imports the Citrix user profile from the user store.

If Local profile conflict handling is not configured here, the value from the .ini file is used. If this setting is not configured here or in the .ini file, existing local profiles are used.

For your changes to take effect, run the `gpupdate /force` command from the command prompt as documented at <https://docs.microsoft.com/en-us/windows-server/administration/windows-commands/gpupdate>.

Specify a template or mandatory profile

August 6, 2024

By default, new Citrix user profiles are created from the default user profile on the computer where a user first logs on. Profile Management can alternatively use a centrally stored template when creating profiles. The template can be a standard roaming, local, or mandatory profile that resides on any network file share.

Any variation in different devices' default user profiles results in differences in the base profile created for the user. You can regard your selection of a template profile as a Global Default User profile.

As prerequisites:

- Ensure that the template profile does not contain any user-specific data
- Ensure that users have read access to the template profile
- Convert a mandatory profile to a template profile by renaming the file NTUSER.MAN to NTUSER.DAT
- Remove SACLs from NTUSER.DAT in the template profile

For information on creating template profiles by customizing existing Microsoft profiles, see <https://support.microsoft.com/kb/959753> and <https://support.microsoft.com/kb/973289>.

1. Under Profile Management, open the Profile handling folder.
2. Double-click the **Template profile** policy.
3. Select Enabled.
4. In **Path to the template profile**, enter the location of the profile you want to use as a template or mandatory profile. This path is the full path to the folder containing the NTUSER.DAT registry file and any other folders and files required for the template.

Important: If the path consists only of NTUSER.DAT, ensure that you do not include the file name in the path. For example, with the file `\\myservername\myprofiles\template\ntuser.dat`, set the location as `\\myservername\myprofiles\template`.

Use absolute paths, which can be UNC paths or paths on the local machine. You can use the latter, for example, to specify a template profile permanently on a Citrix Provisioning Services image. Relative paths are not supported.

This policy does not support expansion of Active Directory attributes, system environment variables, or the `%USERNAME%` and `%USERDOMAIN%` variables.

5. Optionally, select a check box to override any existing Windows user profiles. If a user has no Citrix user profile, but a local or roaming Windows user profile exists, by default the local profile is used. And this file is migrated to the user store, if this is not disabled. You can change the setting by enabling the **Template profile overrides local profile** or **Template profile overrides roaming profile** check box. Also, identify the template as a Citrix mandatory profile. Like Windows mandatory profiles, changes cannot be saved to Citrix mandatory profiles.

If **Template profile** is not configured here, the value from the .ini file is used. If this setting is not configured here or in the .ini file, no template or mandatory profile is used.

For your changes to take effect, run the `gpupdate /force` command from the command prompt as documented at <https://docs.microsoft.com/en-us/windows-server/administration/windows-commands/gpupdate>.

Choose a migration policy

August 6, 2024

When a user first logs on after Profile Management is enabled, no Citrix user profile for them exists. But you can migrate their existing Windows user profile “on the fly” during logon. Decide which existing profile (roaming, local, or both) is copied and used in all further processing.

For more information on planning a migration strategy, see [Migrate or create profiles](#). In addition, review the system requirements for migrating existing profiles in [System requirements](#).

1. Under Profile Management, open the Profile handling folder.
2. Double-click the Migration of existing profiles policy.
3. Select Enabled.
4. Select one of the following options from the drop-down list:
 - Local. Use this setting if you are migrating local profiles.
 - Local and Roaming. Use this setting if you are migrating local and roaming profiles (including Remote Desktop Services profiles, formerly known as Terminal Services profiles).
 - Roaming. Use this setting if you are migrating roaming profiles or Remote Desktop Services profiles.

If Migration of existing profiles is not configured here, the value from the .ini file is used. If this setting is not configured either here or in the .ini file, existing local and roaming profiles are migrated. If this setting is disabled, no profile is migrated. If this setting is disabled and no Citrix user profile exists in the user store, the existing Windows mechanism for creating profiles is used as in a setup without Profile Management.

For your changes to take effect, run the `gpupdate /force` command from the command prompt as documented at <https://docs.microsoft.com/en-us/windows-server/administration/windows-commands/gpupdate>.

Define which groups' profiles are processed

August 6, 2024

You can define the users whose profiles are processed and profiles that are not. You can use both computer local groups and domain groups (local, global, and universal). Specify domain groups in the format <DOMAIN NAME>\<GROUP NAME>. Specify local groups in the format GROUP NAME.

Note Computer local groups must be newly created local groups and the members must be domain users.

1. Under Profile Management, double-click the **Processed groups** policy.
2. Select **Enabled**.
3. Click **Show**.
4. Add the groups containing the users whose profiles you want Profile Management to process. Use Enter to separate multiple entries.

If this setting is not configured here, the value from the .ini file is used. If this setting is not configured here or in the .ini file, members of all user groups are processed unless you exclude them using the Excluded groups policy.

5. Under Profile Management, double-click the Excluded groups policy.
6. Select **Enabled**.
7. Click **Show**.
8. Add the groups containing the users you do not want Profile Management to process. Use Enter to separate multiple entries.

If this setting is not configured here, the value from the .ini file is used. If this setting is not configured here or in the .ini file, no members of any groups are excluded.

9. To manage the profiles of local administrators, under Profile Management, double-click the **Process logons of local administrators** policy and click **Enabled**.

Important: By default, Profile Management recognizes which operating system is in use, and processes the accounts of local administrators on desktop, not server, operating systems. The reason is that users are typically members of the Local Administrators group only on desktops, and excluding local administrators from processing in server environments assists with troubleshooting. Therefore only enable this policy if you want to modify the default behavior.

The **Excluded groups** policy takes precedence over the **Process logons of local administrators** policy. If an account appears in both policies, Profile Management does not process it.

If this setting is not configured here, the value from the .ini file is used. If this setting is not configured here or in the .ini file, the profiles of local administrators are not processed.

For your changes to take effect, run the `gpupdate /force` command from the command prompt as documented at <https://docs.microsoft.com/en-us/windows-server/administration/windows-commands/gpupdate>.

Migrate user store

August 6, 2024

Profile Management provides a solution to migrate your user store without losing any data. This feature can be useful in cases where you want to migrate your user store to a more scalable file server.

To migrate your user store, use the Migrate user store policy along with the Path to user store policy. The Migrate user store policy lets you specify the path to the folder where the user settings (registry changes and synchronized files) were previously saved (the user store path that you previously used).

The path can be an absolute UNC path or a path relative to the home directory. In both cases, you can use the following types of variables:

- System environment variables (enclosed in percent signs)
- Attributes of the Active Directory user object (enclosed in hash signs)

Examples:

- The folder `Windows\%ProfileVer%` stores the user settings in a subfolder called `Windows\W2K3` of the user store (if `%ProfileVer%` is a system environment variable that resolves to `W2K3`).
- `\\server\share\%SAMAccountName%` stores the user settings to the UNC path `\\server\share\<JohnSmith>` (if `%SAMAccountName%` resolves to `JohnSmith` for the current user).

In the path, you can't use user environment variables except `%username%` and `%userdomain%`.

If this setting is disabled, the user settings are saved in the current user store.

If this setting is not configured here, the corresponding setting from the `.ini` file is used.

If this setting is not configured here or in the `.ini` file, the user settings are saved in the current user store.

After the changes to the policy settings take effect, the user settings stored in the previous user store are migrated to the current user store specified in the **Path to user store** policy.

To configure the migration of the user store in Group Policy, complete the following steps:

1. Open the Group Policy Management Editor.
2. Under **Policies > Administrative Templates: Policy definitions (ADMX files) > Citrix Components > Profile Management**, double-click the **Migrate user store** policy.
3. Select **Enabled**.
4. In the **Options** pane, type the user store path that you previously used.
5. Click **OK**.

For your changes to take effect, run the `gpupdate /force` command from the command prompt. Log off from all sessions and then log on again. For details, see <https://docs.microsoft.com/en-us/windows-server/administration/windows-commands/gpupdate>.

You can also choose to configure the Profile Management policies in Citrix Studio. To do so, complete the following steps:

1. In the left pane of Citrix Studio, click **Policies**.
2. In the **Create Policy** window, type the policy in the search box. For example, type "Migrate user store."
3. Click **Select** to open the **Migrate user store** policy.

4. Select **Enabled** and then type the user store path that you previously used.
5. Click **OK**.

Automatic migration of existing application profiles

August 6, 2024

Profile Management provides a solution that can automatically migrate existing application profiles. The application profiles include both the application data in the **AppData** folder and the registry entries under `HKEY_CURRENT_USER\SOFTWARE`.

This feature can be useful in cases where you want to migrate your application profiles across different operating systems (OSs). For example, suppose you upgrade your OS from Windows 10 version 1803 to Windows 10 version 1809. If this feature is enabled, Profile Management automatically migrates the existing application settings to Windows 10 version 1809 the first time each user logs on. As a result, the application data in the **AppData** folder and the registry entries under `HKEY_CURRENT_USER\SOFTWARE` are migrated. Users no longer need to configure the applications again.

Note:

This feature requires you to specify the short name of the OS by including the `!CTX_OSNAME!` variable in the user store path.

This feature currently supports Windows 10 1909 and earlier, Windows Server 2019, Windows Server 2016, and Windows Server 2012 R2.

This feature is disabled by default. To enable it in Group Policy, complete the following steps:

1. Open the Group Policy Management Editor.
2. Under **Policies > Administrative Templates: Policy definitions (ADMX files) > Citrix Components > Profile Management > Profile handling**, double-click the **Automatic migration of existing application profiles** policy.
3. Select **Enabled** and then click **OK**.

For your changes to take effect, run the `gpupdate /force` command from the command prompt. Log off from all sessions and then log on again. For more information, see <https://docs.microsoft.com/en-us/windows-server/administration/windows-commands/gpupdate>.

You can also choose to configure the Profile Management policies in Citrix Studio. To do so, complete the following steps:

1. In the left pane of Citrix Studio, click **Policies**.

2. In the **Create Policy** window, type the policy in the search box. For example, type “Automatic migration of existing application profiles.”
3. Click **Select** to open the **Automatic migration of existing application profiles** policy.
4. Select **Enabled** and then click **OK**.

How it works

Profile Management performs the migration when a user logs on and there are no user profiles in the user store. Before the migration starts, Profile Management locates the application profiles to be migrated. It does so through automatic discovery. It automatically locates and migrates the following:

- Application settings under %userprofile%\Appdata\Local\ and %userprofile%\Appdata\Roaming. The following Microsoft folders that contain the current OS platform information are ignored:

```
1 - %userprofile%\AppData\Local\Temp
2 - %userprofile%\AppData\Local\Packages
3 - %userprofile%\AppData\Local\TileDataLayer
4 - %userprofile%\AppData\Local\Microsoft\Temp
5 - %userprofile%\AppData\Local\Microsoft\Credentials
6 - %userprofile%\AppData\Local\Microsoft\Windows
7 - %userprofile%\AppData\Local\Microsoft\Windows\
  InputPersonalization
8 - %userprofile%\AppData\Local\Microsoft\Windows\Side bars
9 - %userprofile%\AppData\Local\Microsoft\WindowsApps
10 - %userprofile%\Appdata\Roaming\Microsoft\Credentials
11 - %userprofile%\Appdata\Roaming\Microsoft\SystemCertificates
12 - %userprofile%\Appdata\Roaming\Microsoft\Crypto
13 - %userprofile%\Appdata\Roaming\Microsoft\Vault
14 - %userprofile%\Appdata\Roaming\Microsoft\Windows
```

- Registry keys under HKEY_CURRENT_USER\SOFTWARE and HKEY_CURRENT_USER\SOFTWARE\Wow6432Node (except for HKEY_CURRENT_USER\SOFTWARE\Microsoft and HKEY_CURRENT_USER\SOFTWARE\Classes)

If there are multiple existing application profiles, Profile Management performs the migration in the following order of priority:

1. Profiles of the same OS type (single-session OS to single-session OS and multi-session OS to multi-session OS).
2. Profiles of the same Windows OS family; for example, Windows 10 to Windows 10, or Windows Server 2016 to Windows Server 2016).
3. Profiles of an earlier version of the OS; for example, Windows 7 to Windows 10, or Windows Server 2012 to Windows 2016.
4. Profiles of the closest OS.

Note:

You must specify the short name of the OS by including the `!CTX_OSNAME!` variable in the user store path. Doing so lets Profile Management locate the existing application profiles.

Suppose you configure the user store path as `\\filesERVER\userstore\%username%\!CTX_OSNAME!!CTX_OSBITNESS!` and your OS is Windows 10 version 1803 64-bit (Win10RS4x64). Profile Management first locates the previous profile folder and then migrates it to the application profile folder in the user store in the following order:

1. `\filesERVER\userstore\user1\Win10RS3x64`
2. `\filesERVER\userstore\user1\Win10RS2x64`
3. `\filesERVER\userstore\user1\Win10RS1x64`
4. `\filesERVER\userstore\user1\Win10x64`
5. `\filesERVER\userstore\user1\Win10RS5x64`
6. `\filesERVER\userstore\user1\Win10RS6x64`
7. `\filesERVER\userstore\user1\Win8x64`
8. `\filesERVER\userstore\user1\Win7x64`
9. `\filesERVER\userstore\user1\Win2016`
10. `\filesERVER\userstore\user1\Win2012R2`
11. `\filesERVER\userstore\user1\Win2012`
12. `\filesERVER\userstore\user1\Win2008`
13. `\filesERVER\userstore\user1\Win2019`

If none of them is available, Profile Management ends the migration process and returns an error.

Store certificates

August 6, 2024

Follow this procedure to save personal certificates that have been imported into the certificate store during a session. By default, certificates are automatically synchronized.

Add the path `Application Data\Microsoft\SystemCertificates\My` to the setting **Directories to synchronize**. The operating system language determines the Application Data folder in this location. If a policy is used to configure multi-language systems, add each language's location to the list.

Example

On an English system, the path is `Application Data\Microsoft\SystemCertificates\My`. On a German system, it is `Anwendungsdaten\Microsoft\SystemCertificates\My`.

For your changes to take effect, run the `gpupdate /force` command from the command prompt as documented at <https://docs.microsoft.com/en-us/windows-server/administration/windows-commands/gpupdate>.

Configure folder redirection

August 6, 2024

Folder redirection is a feature of Microsoft Windows and can be used with Profile Management.

Important:

Configure folder redirection using only one of these methods: Microsoft Active Directory (AD) GPOs or Citrix policies. Using multiple methods to configure folder redirection might cause unpredictable results.

To configure folder redirection, complete the following steps:

1. Move applicable users to an OU that Profile Management manages.
2. Create a GPO and then open it for editing.
3. Navigate to **User Configuration > Administrative Templates > Citrix Components > Profile Management > Folder Redirection** and then select the folder you want to redirect.
4. Enable the Redirect the <folder name> folder policy and then type the redirected path. Do not add redirected folders as exclusions. Do not add user names or folder names to the path. For example, if you set the path to the **Desktop** folder as `\\server\share\`, the folder in the user environment is redirected as `\\server\share\\Desktop`.
5. For your changes to take effect, run the `gpupdate /force` command from the command prompt. For details, see <https://docs.microsoft.com/en-us/windows-server/administration/windows-commands/gpupdate>.

The following folders can be redirected:

- AppData(Roaming)
- Desktop
- Start menu

- Documents
- Pictures
- Music
- Videos
- Favorites
- Contacts
- Downloads
- Links
- Searches
- Saved Games

When redirecting folders, keep the following in mind:

- The **Documents** folder. You can redirect it to the user's home directory.
- The **Music**, **Pictures**, and **Videos** folders. You can redirect them to folders relative to the **Documents** folder.

How to verify that folder redirection works

To verify that folder redirection works, complete the following steps:

1. In a session, navigate to a folder you directed, right-click the folder, and then select **Properties**.
2. In the properties window, navigate to the **Shortcut** tab and then check the **Target** field. If the field displays a redirected path, folder redirection works. Otherwise, folder redirection does not work.

Folder redirection logs

Note:

Profile Management writes information to the Windows event log only when folder redirection fails.

Profile Management writes information to the Windows event log. You can view the events in the **Application** pane of the Windows Event Viewer. The information helps you troubleshoot issues you experience when using the folder redirection feature.

Manage transactional folders

August 6, 2024

A transactional folder refers to a folder that contains interdependent files, where one file references other files. The **Folders to mirror** policy ensures the integrity of transactional folders during profile synchronization. With this policy, Profile Management mirrors the entire transactional folder between the user store and the local user profile.

The **Accelerate folder mirroring** policy is available with Profile Management 2106 and later.

This article guides you through the process of managing transactional folders using the **Folders to mirror** policy. It also gives an example of how to manage Internet Explorer cookie folders using this policy.

How the folder mirroring works

Generally, when Profile Management synchronizes user profiles between the user store and the local profiles, it synchronizes only updated files by comparing time stamps. However, in a transactional folder, files in it are associated, and Profile Management must synchronize the entire folder to avoid integrity issues. An example of transactional folders is a folder that contains transaction log files and the corresponding database files. Mixing transaction log files and database files from different sessions can cause transactional integrity issues.

To synchronize transactional folders correctly, Profile Management provides the **Folders to mirror** policy. When synchronizing a transactional folder to the destination, Profile Management mirrors the folder to the destination by using the following steps:

1. Copies all contents in the folder to the destination, ignoring time stamps.
2. Deletes any additional contents in the destination.

Caution:

Mirroring transactional folders means the “last write wins.” Files that are modified in more than one session are overwritten by the latest update and profile changes might be lost.

Specify folders to mirror

Enable the **Folders to mirror** policy and specify the folders to mirror.

Let’s take Google Chrome as an example. The bookmark-related files and subfolders in `AppData\Local\Google\Chrome\User Data\Default` are interdependent and must be processed as a whole during profile synchronization. To achieve this goal, you need to add this folder to the **Folders to mirror** policy.

You can also exclude files and subfolders from a folder to mirror. In the previous example, the `AppData\Local\Google\Chrome\User Data\Default` folder also contains files and

subfolders unrelated to bookmarks. You can use the **Exclusion list –directories** and **Exclusion list –files** policies to exclude them.

Detailed steps are as follows:

1. Go to **Profile Management > File system > Synchronization**, and then double-click the **Folders to mirror** policy.
2. Select **Enabled**.
3. In the **List of folders to mirror** field, type the list of folders that you want to mirror in the format of relative paths to the user store. Type **Enter** to separate folders.

Note:

This policy works recursively. Don't add subfolders to the list.

For example, if you add `AppData\Roaming\Microsoft\Windows\Cookies`, don't add `AppData\Roaming\Microsoft\Windows\Cookies\Low`.

4. Click **OK**.
5. To exclude certain files and subfolders in a mirrored folder from the mirroring process, follow these steps:
 - a) Go to **Profile Management > File system**, and then double-click the **Exclusion list –directories** policy or the **Exclusion list –files** policy.
 - b) Specify the files and subfolders to exclude.

Configuration precedence:

1. If this policy isn't configured here, the value from the .ini file is used.
2. If this setting is not configured either here or in the .ini file, no folders are mirrored.

Accelerate folder mirroring

Starting with Profile Management 2106, you can accelerate folder mirroring by enabling the **Accelerate folder mirroring** policy.

With this policy enabled, Profile Management stores mirrored folders on a VHDX-based virtual disk. Profile Management attaches the virtual disk during logons and detaches it during logoffs, eliminating the need to copy the folders between the user store and the local profiles.

To enable this policy, follow these steps:

1. Under **Profile Management > File system > Synchronization**, double-click the **Accelerate folder mirroring** policy.

2. Select **Enabled**.
3. Click **OK**.

Configuration precedence:

1. If this policy isn't configured here, the value from the .ini file is used.
2. If this setting is not configured either here or in the .ini file, the policy is disabled.

Example: Manage Internet Explorer cookie folders

When managing the Internet Explorer cookies folder, you need to ensure transactional integrity while reducing profile bloat. To achieve this goal, use the **Folders to mirror** and **Process Internet cookie files on logoff** policies.

Detailed steps are as follows:

1. Specify cookie folders to mirror.
2. If the profile bloat issue occurs, enable deletion of stale cookies on user logoff.

For your changes to take effect, run the `gpupdate /force` command from the command prompt, as documented in this [Microsoft article](#).

Overview

This section explains how the two policies help manage cookies folders.

Let's take the Internet Explorer 8 cookies folder as an example. That folder contains index.dat and cookies files. Index.dat references cookie files when users browse the Internet. For example, a user has two Internet Explorer sessions, each from a different device, and the user visits different sites in each session. Cookies from each site are added to the corresponding devices.

How to ensure transactional integrity Let's see what happens when the user logs off from both sessions in the preceding example. Cookies from the sessions are merged while the index.dat file is synchronized with the one from the last logged off session. As a result, the cookies files and the references to those cookie files in index.dat become unmatched.

The **Folders to mirror** policy resolves the issue. With this policy set, Profile Management copies the entire folder to the destination during profile synchronization. For more information about how this policy works, see [Manage transactional folders](#).

How to avoid profile bloat Browsing in new sessions results in a bloated cookie folder. Also, when websites are revisited, stale cookies build up. The **Process Internet cookie files on logoff** policy resolves the issue by removing stale cookies from the profile on user logoff.

Note:

Cookies and browsing history information from Internet Explorer 9 and earlier are not compatible with cookies and browsing history information from Internet Explorer 10 and later. Users are advised not to move across multiple systems that have different versions of Internet Explorer installed. [#474200]

Specify cookie folders to mirror

Enable the **Folders to mirror** policy. In the policy, based on the OS versions supported in your deployment, specify the cookie folders to mirror.

1. Go to **Profile Management > File system > Synchronization**.
2. Double-click the **Folders to mirror** policy.
3. Select **Enabled**.
4. In the **List of folders to mirror** field, add the following cookie folders. Use **Enter** to separate folders.
 - `AppData\Roaming\Microsoft\Windows\Cookies` for Version 2 profiles.
 - `AppData\Local\Microsoft\Windows\INetCookies` (cookies folder for Windows 8.1 and later)
 - `AppData\Roaming\Microsoft\Windows\Cookies` (cookies folder for Windows 7 and Windows 8)
 - `AppData\Local\Microsoft\Windows\WebCache` (folder available for Internet Explorer 10 and later where the cookie database file `Webcache01.dat` is stored)
5. Click **OK**.
6. If you're using Profile Management 2106 or later, double-click the **Accelerate folder mirroring** policy, and then select **Enabled**.

(Optional) Delete stale cookies on logoff

To have Profile Management delete stale cookies on user logoff, enable the **Process Internet cookie files on logoff** policy.

The policy increases the logoff time, so enable it only when you experience profile bloat issues.

1. Go to **Profile Management > Advanced Settings**.

2. Double-click the **Process Internet cookie files on logoff** policy.
3. Select **Enabled**.
4. Click **OK**.

Configure offline profiles

August 6, 2024

Citrix offline profiles are intended for laptop users or mobile-device users who roam with intermittent access to a network. This feature allows profiles to synchronize with the user store at the earliest possible opportunity. When a network disconnection occurs, profiles remain intact on the laptop or device even after restarting or hibernating. As mobile users work, their profiles are updated locally and are eventually synchronized with the user store when the network connection is re-established.

This feature works only with domain-joined computers (including ones running Citrix XenClient). It is not intended for use with servers or desktop computers, whose network connections tend to be permanent.

Typically, you don't enable both offline profiles and streamed user profiles. For this reason, offline profiles take over precedence and disable streamed user profiles and the Delete locally cached profiles on logoff setting. Ensure that users always have a complete profile on their laptop or mobile device when they first log on.

You can configure offline profiles in these ways:

- **Using Group Policy.** This policy gives you centralized administrative control of the feature but you must create a separate OU containing the laptops or devices that use offline profiles.
- **Using the .ini file.** It is an easier option if you prefer not to create a special OU just for laptops and mobile devices. But it effectively hands control of this feature to individual device owners. This option requires a once-only configuration of each laptop or mobile device.

If Offline profile support is not configured using Group Policy, the value from the .ini file is used. If this setting is not configured in Group Policy or in the .ini file, offline profiles are disabled.

Using Group Policy

1. Create an OU containing all computers managed by Profile Management. Include the laptops and mobile devices that use offline profiles, your Citrix virtual apps servers, and your virtual desktops.
2. Create a child OU containing only the laptops and mobile devices.

3. In Group Policy Management, create a baseline Group Policy Object (GPO) that enforces your site-wide policies, and link it to both OUs.
4. Configure the baseline GPO with the Profile Management settings common to all computers.
5. Create a second, offline GPO and link it to the child OU.
6. Configure the offline GPO as follows:
 - a) Under Profile Management, double-click Offline profile support.
 - b) Select Enabled and click OK.
 - c) Configure any other settings that you want to apply only to laptops and mobile devices.

For your changes to take effect, run the `gpupdate /force` command from the command prompt as documented at <https://docs.microsoft.com/en-us/windows-server/administration/windows-commands/gpupdate>.

Using the .ini file

As a prerequisite, ensure that Offline profile support is unconfigured (the default) in both the baseline and offline GPO. If these settings are configured, the .ini file setting is overridden.

1. On each laptop or mobile device, locate the .ini file created by the Profile Management installer. To locate the .ini file, see [Files included in the download](#).
2. Uncomment this line (by removing the semi-colon from it):

```
pre codeblock ;OfflineSupport=
```

3. Save the .ini file.

For your changes to take effect, run the `gpupdate /force` command from the command prompt as documented at <https://docs.microsoft.com/en-us/windows-server/administration/windows-commands/gpupdate>.

Configure the Customer Experience Improvement Program (CEIP)

August 6, 2024

To configure the CEIP, follow these steps:

1. Open the Group Policy Management Editor.
2. Under **Computer Configuration > Policies > Administrative Templates: Policy definitions (ADMX files) > Citrix Components > Profile Management > Advanced settings**, double-click **Customer Experience Improvement Program**.

3. Select **Enabled** or **Disabled**, then click **OK**.
4. For your changes to take effect, run the `gpupdate /force` command from the command prompt as documented at <https://docs.microsoft.com/en-us/windows-server/administration/windows-commands/gpupdate>.

Note:

- For machines in non-European regions, if this policy isn't configured in GPOs, the value from the .ini file is used. If this policy isn't configured in GPOs or in the .ini file, CEIP is enabled.
- For machines in European regions, if this policy isn't configured in GPOs, CEIP is disabled regardless of the value from the .ini file.

For more information about CEIP, see [About the Citrix Customer Experience Improvement Program \(CEIP\)](#).

Configure active write-back

August 6, 2024

By default, Profile Management writes changes that are made to the local user profile back to the user store when a user logs off. If a user starts a second session before logging off the first, local profile changes made in the first session aren't available in the second.

To improve profile consistency across concurrent sessions, you can enable the active write-back feature. With this feature, Profile Management writes local profile changes back to the user store *during a session*, rather than waiting until users log off.

Overview

Profile Management provides the **Active write-back** policy and two extension policies as follows:

- **Active write-back.** Has Profile Management write changes made to the local *profile files and folders* back to the user store. By default, Profile Management performs active write-back every five minutes.
- **Active write back registry.** Use it along with the **Active write-back** policy. Has Profile Management write changes made to the local *registry entries* back to the user profile.
- **Active write back on session lock and disconnection.** Use it along with the **Active write-back** policy. Has Profile Management perform active write-back only when a session is locked or disconnected, instead of every five minutes.

Enable active write-back

To enable active write-back using a GPO, follow these steps:

1. Open the Group Policy Management Editor.
2. Access **Policies > Administrative Templates: Policy definitions (ADMX files) > Citrix Components > Profile Management**.
3. Double-click **Active write back**.
4. In the policy window that appears, select **Enabled**, and then click **OK**.
By default, active write-back occurs every five minutes.
5. To enable active write-back for registry entries, follow these steps:
 - a) Double-click **Active write back registry**.
 - b) In the policy window that appears, select **Enabled**, and then click **OK**.
6. To have Profile Management perform active write-back only when a session is locked or disconnected, follow these steps:
 - a) Double-click **Active write back on session lock and disconnection**.
 - b) In the policy window that appears, select **Enabled**, and then click **OK**.

Note:

As a best practice, we recommend that you enable the **Active write back on session lock and disconnection** policy.

The configuration precedence for an active write-back policy is as follows:

- If the setting isn't configured using a GPO, Studio, or Workspace Environment Management (WEM), the value from the .ini file is used.
- If the setting isn't configured anywhere, Profile Management configures it dynamically.

For your changes to take effect, run the `gpupdate /force` command from the command prompt as documented at <https://docs.microsoft.com/en-us/windows-server/administration/windows-commands/gpupdate>.

Configure cross-platform settings

August 6, 2024

Important: Note the following important information for this feature:

- Cross-platform settings in Profile Management support a set of supported operating systems (OSs) and applications. Configure this feature only in a production environment.

- Microsoft Office settings do not roam between versions of that application. For more information, see [Operating systems and applications supported By cross-platform settings](#).
- This feature is suitable for registry and application settings. It is not for files or folders, or objects typically used with folder redirection (for example, browser favorites, and desktop and Start menu settings).
- If you use this feature to migrate user profiles between systems with different profile versions, disable it after the migration has been completed for all users. There is some performance impact, primarily to logoffs, when using this feature. So it is best to leave it disabled unless you support roaming between profile versions.

This topic contains an example of the steps you can take to configure cross-platform settings. For a more detailed case study, see [Cross-platform settings - Case study](#).

Tip: We recommend restricting this feature to a small, test set of users before putting it into production. Use the

Cross-platform settings user groups option to achieve it. If this setting is configured, the cross-platform settings feature of Profile Management processes only members of these user groups. If this setting is disabled, the feature processes all the users specified by the Processed groups setting. If

Cross-platform settings user groups is not configured in Group Policy or the .ini file, all user groups are processed.

1. For the settings that are common to all platforms, create a common Group Policy Object (common GPO), link it to the Profile Management .adm or .admx file, and configure the settings as required. This setup is best practice because it minimizes duplicate settings that can make any later troubleshooting awkward. Depending on your requirements, all Profile Management settings work on multiple platforms except **Path to user store**. Configure Path to user store separately for each platform due to the different user store structures of Version 1 and Version 2 profiles. In the common GPO, leave this setting unconfigured.
2. Create separate OUs for your different platforms. For example, if you are migrating from Windows 7 to Windows 8, create separate OUs for these operating systems), and set Path to user store appropriately in each OU.
3. Locate the definition (.xml) files for the supported applications whose personalizations you want to work across the platforms. These files are located in the CrossPlatform folder in the download package. You can create your own application definition files. For details, see [Create a definition file](#).
4. Copy the .xml files to a suitable location on your network.
5. Edit the common GPO in Group Policy Management Editor. Under Profile Management open the Cross-platform settings folder and configure these settings:
 - Cross-platform settings user groups. Restricts the users who experience cross-platform settings. This setting is optional. It is useful when testing this feature or rolling it out in

stages.

- Path to cross-platform definitions. Identifies the network location of the definition files that you copied from the download package. This path must be a UNC path. Users must have read access to this location, and administrators must have write access to it. The location must be a Server Message Block (SMB) or Common Internet File System (CIFS) file share.
 - Path to cross-platform settings store. It is the common area of the user store where profile data shared by multiple platforms is located. Users must have write access to this area. The path can be an absolute UNC path or a path relative to the home directory. You can use the same variables as for **Path to user store**.
6. Specify a base platform by ensuring Source for creating cross-platform settings is set to Enabled in that platform's OU. This setting migrates data from the base platform's profiles to the cross-platform settings store. In the other platforms' OUs, set this policy to Disabled or Unconfigured. Each platform's own set of profiles are stored in a separate OU. You must decide which platform's profile data to use to seed the cross-platform settings store. This is referred to as the base platform. If the cross-platform settings store contains a definition file with no data, or the cached data in a single-platform profile is newer than the definition's data in the store, Profile Management migrates the data from the single-platform profile to the store unless you disable this setting.
Important: If Source for creating cross-platform settings is enabled in multiple OUs, the platform that the first user logs on to becomes the base profile.
 7. Set Enable cross-platform settings to Enabled. By default, to facilitate deployment, cross-platform settings is disabled until you turn on this setting.
 8. Run a Group Policy update.
 9. If you are migrating profiles across platforms but not supporting roaming of them, when the migration is complete, set Enable cross-platform settings to **Disabled**.

If Path to cross-platform definitions is not configured here, the value from the .ini file is used. If this setting is not configured here or in the .ini file, no cross-platform settings are applied.

If Path to cross-platform settings store is disabled, the default path Windows\PM_CP is used. If this setting is not configured here, the value from the .ini file is used. If this setting is not configured here or in the .ini file, the default path is used.

If Enable cross-platform settings is not configured here, the value from the .ini file is used. If this setting is not configured here or in the .ini file, no cross-platform settings are applied.

Example: Roaming Microsoft Office settings between Windows Server 2008 and Windows 7

This example describes the major steps involved in allowing users' application settings to roam between two operating systems that create Version 2 profiles. Microsoft Office 2010 is the example application, and roaming takes place between Citrix XenApp 6.5 on Windows Server 2008 and Windows 7. Both OSs are 64-bit.

1. Users are accustomed to accessing Office 2010 and Internet Explorer 9 as published applications on Citrix virtual apps servers, and change several settings in these applications. For example, they modify their email signature in Office and choose a new home page in Internet Explorer.
2. At a future date, virtual desktops (created with Citrix Virtual Desktops) are created but not yet released to users. The desktops run Windows 7 and are preconfigured with Office 2010 and Internet Explorer 9.
3. The users expect their settings to be the same on their new desktops. You configure the cross-platform settings feature according to the procedure in this topic. It includes enabling Source for creating cross-platform settings in the OU for Windows Server 2008.
4. When users next run the published versions of the applications (not the new, virtual desktops), their settings are copied to the cross-platform settings store.
5. The new desktops are then released to users. When they log on and run the local versions of Office and Internet Explorer, the settings from the earlier Windows Server 2008 sessions are used. Users' modified email signatures and home pages are available on their Windows 7 machines.
6. Users browse in Internet Explorer from their virtual desktop, and decide to change their home page again.
7. Users log off and leave work. They don't have access to their virtual desktop at home, but they can run the published version of Internet Explorer 9 remotely. They find their most recent home page, created on Windows 7 in the previous step, has been preserved.

Operating systems and applications supported by cross-platform settings

August 6, 2024

This article describes the applications and operating systems (OSs) supported by the cross-platform settings feature in this release of Profile Management.

About definition files

Definition files contain common personalizations for selected Windows applications. Each file and the definitions within it allow users to connect to the same application on multiple OSs, presenting essentially identical profiles on each platform. For example, users might access two instances of Microsoft Office. One is installed on a Windows 7 virtual desktop and the other is published with Citrix Virtual Apps on Windows Server 2003. Whichever instance is accessed, users' experience of Office is consistent.

Preconfigured definition files are a key aspect of the cross-platform settings feature. There is a definition file for each supported application. Definition files are in an XML format.

Important: Without a thorough analysis of an application's behavior across all OSs and a full understanding of this feature's operation, editing of definition files can result in unexpected changes to users' profiles that can be difficult to troubleshoot. For this reason, Citrix does not support the editing of the supplied definition files or the creation of new ones. In addition, some application settings cannot be duplicated across OSs due to the nature of Windows user profiles.

In addition note that, although this feature is suitable for registry and application settings, it is not suitable for files or folders, or objects typically used with folder redirection (for example, browser favorites, and desktop and Start menu settings).

Supported operating systems

You can roam profiles between any of the supported single-session OSs, and between any of the supported multi-session OSs.

The following are supported (x86 and x64 versions as applicable):

- **Single-session OSs.** Windows XP, Windows 7, and Windows Vista.
- **Multi-session OSs.** Windows Server 2003, Windows Server 2008, and Windows Server 2008 R2.

Supported Citrix products

The cross-platform settings feature supports the following Citrix products:

- XenApp 5 Feature Pack for Windows Server 2003 and later
- XenDesktop 4 and later

Supported applications

The following definition files are available in this release. The XML file name indicates the supported application and versions.

- **Internet Explorer 7 Plus.xml.** This file supports the roaming of Versions 7, 8, and 9 of Internet Explorer (except favorites) across platforms. The roaming of favorites and feeds is not supported.
- **Office 2007.xml.**
- **Office 2010.xml.**
- **Wallpaper.xml.** This file supports the roaming of desktop wallpaper across platforms. The roaming of themes across platforms is not supported.

Important: Use the definition files for each application only in the preceding supported scenarios. For example, Internet Explorer 7 Plus.xml roams settings between multiple versions of that browser. But you cannot use Office 2007.xml or Office 2010.xml to roam settings between versions of Office.

Create a definition file

August 6, 2024

Definition files define the folders, files, or registries to be synchronized. You can create your own application definition files.

Use the Microsoft UE-V template generator to create a UE-V template file.

1. Download the **Windows Assessment and Deployment Kit** (Windows ADK) for Windows 10 from Microsoft [website](#).
2. Install Windows ADK. Select **Microsoft User Experience Virtualization (UE-V) Template Generator**. Click **Install**. Click **Finish** to close the wizard after the installation completes.
3. Click **Start**, click **Microsoft User Experience Virtualization**, and then click **Microsoft User Experience Virtualization Generator**.
4. Click **Create a settings location template**.
5. Follow the wizard to specify application related parameters. Click **Next** to continue. Take Notepad as an example. Specify the file path as **C:\Windows\System32\notepad.exe**.
6. After the specified application starts, close it.
7. After the process completes, click **Next** to continue.
8. Choose **Review Locations** in the left pane. Select all the check boxes in the lists for standard and nonstandard registry/files.
9. Click **Create** to save the template XML file. Take Notepad as the example. Save the template XML file as **Notepad.xml**.

Note

You might have multiple applications defined in a single UE-V template file.

To convert the UE-V template file to a cross-platform definition file, do the following:

1. Download the conversion tool [here](#).
2. From a command prompt, run the command **convert show filename** to display all application names in the definition file.
3. Run the following command to convert the UE-V template file to a definition file.
convert source destination [/Index] [/V]

[/Index]: Convert only the application specified by index number.

By default, this tool converts all applications in the UE-V template.

[/V]: Display verbose information for the conversion.

For cross-platform settings, you must repeat the preceding steps for other operating systems and merge the definition files into one. You can use the **Platform** element with the **OSVersionNumber** attribute to merge the files. On Windows 7, a setting folder is at **AppData\Application\Win7\folder**. On Windows 10, at **AppData\Application\Win10\folder**.

On Windows 7, the definition file you created looks as follows:

```
1 <?xml version="1.0" encoding="utf-8"?>
2
3 <GroupDefinitions Version="4.0.0.0" GUID="93E41C6E-2091-1B9B-36BC-7
  CE94EDC677E">
4
5   <Group Name="Common Settings" GUID="32D83BB6-F3AD-985F-D4BC-655
     B3D9ACBE2">
6
7     <Object Name="!CTX_ROAMINGAPPDATA!\Application\Win7\folder"
       GUID="1B43DE3F-EC9C-463c-AC19-CD01D00219B6">
8
9       <Platform>
10
11         <Folder>
12
13           <Path>!CTX_ROAMINGAPPDATA!\Application\Win7\folder
             </Path>
14
15           <Recurse/>
16
17         </Folder>
18
19       </Platform>
20
21     </Object>
22
23   </Group>
24
25 </GroupDefinitions>
```

On Windows 10, the definition file you created looks as follows:

```

1 <?xml version="1.0" encoding="utf-8"?>
2
3 <GroupDefinitions Version="4.0.0.0" GUID="93E41C6E-2091-1B9B-36BC-7
  CE94EDC677E">
4
5   <Group Name="Common Settings" GUID="32D83BB6-F3AD-985F-D4BC-655
     B3D9ACBE2">
6
7     <Object Name="!CTX_ROAMINGAPPDATA!\Application\Win10\folder"
        GUID="1B43DE3F-EC9C-463c-AC19-CD01D00219B6">
8
9       <Platform>
10
11         <Folder>
12
13           <Path>!CTX_ROAMINGAPPDATA!\Application\Win10\folder
             </Path>
14
15           <Recurse/>
16
17         </Folder>
18
19       </Platform>
20
21     </Object>
22
23   </Group>
24
25 </GroupDefinitions>

```

After merging, the contents of the definition file look as follows:

```

1 <?xml version="1.0" encoding="utf-8"?>
2
3 <GroupDefinitions Version="4.0.0.0" GUID="93E41C6E-2091-1B9B-36BC-7
  CE94EDC677E">
4
5   <Group Name="Common Settings" GUID="32D83BB6-F3AD-985F-D4BC-655
     B3D9ACBE2">
6
7     <Object Name="!CTX_ROAMINGAPPDATA!\Application\%osname%\folder"
        GUID="1B43DE3F-EC9C-463c-AC19-CD01D00219B6">
8
9       <!-- Assuming that the folder locates differently when in
             different platforms -->
10
11       <Platform OSVersionNumber="6.1"> <!-- Win7 -->
12
13         <Folder>
14
15           <Path>!CTX_ROAMINGAPPDATA!\Application\Win7\folder
             </Path>

```

```
16
17         <Recurse/>
18
19     </Folder>
20
21 </Platform>
22
23 <Platform OSVersionNumber="10.0"> <!-- Win10 -->
24
25     <Folder>
26
27         <Path>!CTX_ROAMINGAPPDATA!\Application\Win10\folder
28         </Path>
29
30         <Recurse/>
31
32     </Folder>
33
34 </Platform>
35
36 </Object>
37
38 </Group>
39 </GroupDefinitions>
```

For information about configuring cross-platform settings, see [Configure cross-platform settings](#).

For information about the architecture of definition files, see [Application definition file structure](#).

For information about enabling application profiler, see [Enable application profiler](#).

Application definition file structure

August 6, 2024

This article describes the XML structure of Profile Management application definition files. This structure applies to both application profiler and cross-platform settings.

Architecture Chart

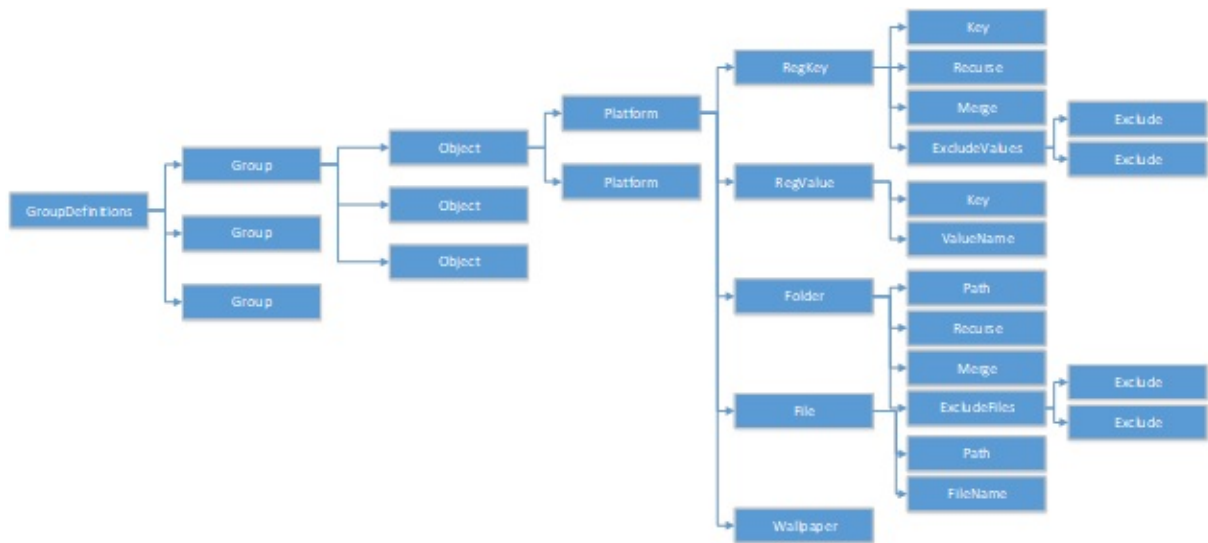

- XML Declaration and Encoding Attribute

The XML declaration must specify the attribute, `<?xml version="1.0">`.

Encoding="UTF-8" is a recommended attribute.

- GroupDefinitions

A container of collections of groups. It acts as the root element of the XML document. Its attributes include version and GUID. They are mandatory attributes.

- Group

Defines settings of a subapplication. Its attributes are name and GUID. They are mandatory attributes.

- Object

Defines one setting of a subapplication. Its attributes are name and GUID. They are mandatory attributes.

- Platform

Platform provides different definitions in different operating systems. It can use an optional attribute OSVersionNumber to specify the operating system. When there is no attribute, all platforms accept the inner definition of the setting. Platform must contain one of the following elements: RegKey, RegValue, File, Folder, and Wallpaper.

- RegKey

Defines a setting as a key in the registry. It must contain the Key element. It includes two optional subelements, Recurse and Merge. Recurse and Merge define the performance when Pro-

file Management roams the key. Another optional subelement is `ExcludeValues`. `ExcludeValues` defines the registry values that can be excluded.

- `RegValue`

Defines a setting as a value in the registry. It must contain `Key` to specify the path of its parent key.

- `Folder`

Defines a setting as a folder. It must contain `Path` to specify the path of the folder. It has optional subelements, `Recurse` and `Merge`. `Recurse` and `Merge` define the performance when Profile Management roams the folder. Another optional subelement is `ExcludeFiles`, which defines the files that can be excluded.

- `File`

Defines a setting as a file. It must contain `Path` to specify the path of its parent folder, and `FileName` to specify the name of a file.

- `Wallpaper`

Defines all wallpaper settings. No attributes or subelements are required. Profile Management roams these settings automatically.

- `Key`

Specifies the path of the registry key or the path of the parent registry key. `Key` is the subelement of `RegKey` and `RegValue`.

- `ValueName`

Specifies the name of the registry value. It is a subelement of `RegValue`.

- `Path`

Specifies the path of the folder or the path of the parent folder. It is a subelement of `Folder` and `File`. Profile Management variables can be adopted.

- `FileName`

Specifies the name of a file. It is a subelement of `File`.

- `Recurse`

Optional subelement of `RegKey` and `Folder`. If this element exists, Profile Management roams the key and the folder recursively.

- `Merge`

Optional subelement of `RegKey` and `Folder`. If this element exists, Profile Management merges (but does not substitute) the key and the folder.

- **ExcludeValues**
Optional subelement of RegKey. Specifies the values that can be excluded when roaming the key.
- **ExcludeFiles**
Optional subelement of Folder. Specifies the files that can be excluded when roaming the folder.
- **Exclude**
Subelement of ExcludeValues and ExcludeFiles. Specifies the excluded items of files or registry values.

Note

Make sure that your document contains a correct syntax format. Profile Management checks these files by using the CPSValidationSchema.xsd validation file when these files load. You can find the validation file under the installation path of Profile Management. Profile Management ignores incorrect files and record error messages in the log.

Sample

```
1 <?xml version="1.0" encoding="UTF-8"?>
2
3 <!-- Copyright 2011 Citrix Systems, Inc. All Rights Reserved. -->
4
5 <GroupDefinitions GUID="748E63D3-426E-4796-9C32-420B25DB2D9F" Version="
   4.0.0.0">
6
7 <!-- Application Settings -->
8
9 <Group GUID="0FCCCF29-0A0E-482d-A77E-3F39A8A854A6" Name="Application
   Settings">
10
11 <!-- Registry Key Setting Example -->
12
13 <Object GUID="637EC13C-2D47-4142-A8EB-3CEA6D53522A" Name="Software\
   Application\certain key">
14
15 <Platform>
16
17 <RegKey>
18
19 <Key>Software\Microsoft\Office\certain key</Key>
20
21 <Merge/>
22
23 <Recurse/>
24
25 <ExcludeValues>
```

```
26
27 <Exclude>excluded value 1</Exclude>
28
29 <Exclude>excluded value 2</Exclude>
30
31 <Exclude>excluded value 3</Exclude>
32
33 </ExcludeValues>
34
35 </RegKey>
36
37 </Platform>
38
39 </Object>
40
41 <!-- Registry Value Setting Example -->
42
43 <Object GUID="3C896310-10C4-4e5f-90C7-A79F4E653F81" Name="Software\
    Application\certain value">
44
45 <!-- Folder Setting Example -->
46
47 <Object GUID="7F8615D0-5E63-4bd0-982D-B7740559C6F9" Name="!
    CTX_ROAMINGAPPDATA!\Application\setting folder">
48
49 <Platform>
50
51 <Folder>
52
53 <!-- We can use Citrix variable if necessary -->
54
55 <Path>!CTX_ROAMINGAPPDATA!\Application\setting folder</Path>
56
57 <Merge/>
58
59 <Recurse/>
60
61 <ExcludeFiles>
62
63 <Exclude>excluded file 1</Exclude>
64
65 <Exclude>excluded file 2</Exclude>
66
67 <Exclude>excluded file 3</Exclude>
68
69 </ExcludeFiles>
70
71 </Folder>
72
73 </Platform>
74
75 </Object>
76
```

```
77 <!-- File Setting Example -->
78
79 <Object GUID="7F8615D0-5E63-4bd0-982D-B7740559C6F9" Name="!
    CTX_ROAMINGAPPDATA!\Application\file.txt">
80
81 <Platform>
82
83 <File>
84
85 <!-- We can use Citrix variable if necessary -->
86
87 <Path>!CTX_ROAMINGAPPDATA!\Application</Path>
88
89 <FileName>file.txt</FileName>
90
91 </File>
92
93 </Platform>
94
95 </Object>
96
97 <!-- Setting based on different OS -->
98
99 <Object GUID="1B43DE3F-EC9C-463c-AC19-CD01D00219B6" Name="!
    CTX_ROAMINGAPPDATA!\Application\%osname%\folder">
100
101 <!-- Assuming that the folder locates differently when in different
    platforms -->
102
103 <Platform OSVersionNumber="6.1">
104
105 <!-- Win7 -->
106
107 <Folder>
108
109 <Path>!CTX_ROAMINGAPPDATA!\Application\Win7\folder</Path>
110
111 <Recurse/>
112
113 </Folder>
114
115 </Platform>
116
117 <Platform OSVersionNumber="10.0">
118
119 <!-- Win10 -->
120
121 <Folder>
122
123 <Path>!CTX_ROAMINGAPPDATA!\Application\Win10\folder</Path>
124
125 <Recurse/>
126
```

```
127 </Folder>
128
129 </Platform>
130
131 </Object>
132
133 </Group>
134
135 </GroupDefinitions>
```

Cross-platform settings - Case study

August 6, 2024

The cross-platform settings feature is primarily used for migrating from Windows 7 and Windows Server 2008 to Windows 8 and Windows Server 2012. This migration might also move from Microsoft Office 2003 or Office 2007 to Office 2010. Given the typical investment in Windows 2003 systems, a significant coexistence phase is expected. The feature is expected to support both migration and sustained coexistence.

This case study starts with an existing Windows 7 and Windows 2008 environment running Office 2007 and adds Windows 8 shared, provisioned virtual desktops.

The case study consists of:

- [Initial configuration](#)
- [Plan the new site](#)
- [Execute the plan](#)
- [Other considerations](#)

Initial configuration

August 6, 2024

The following graphic illustrates the environment configuration in this case study.

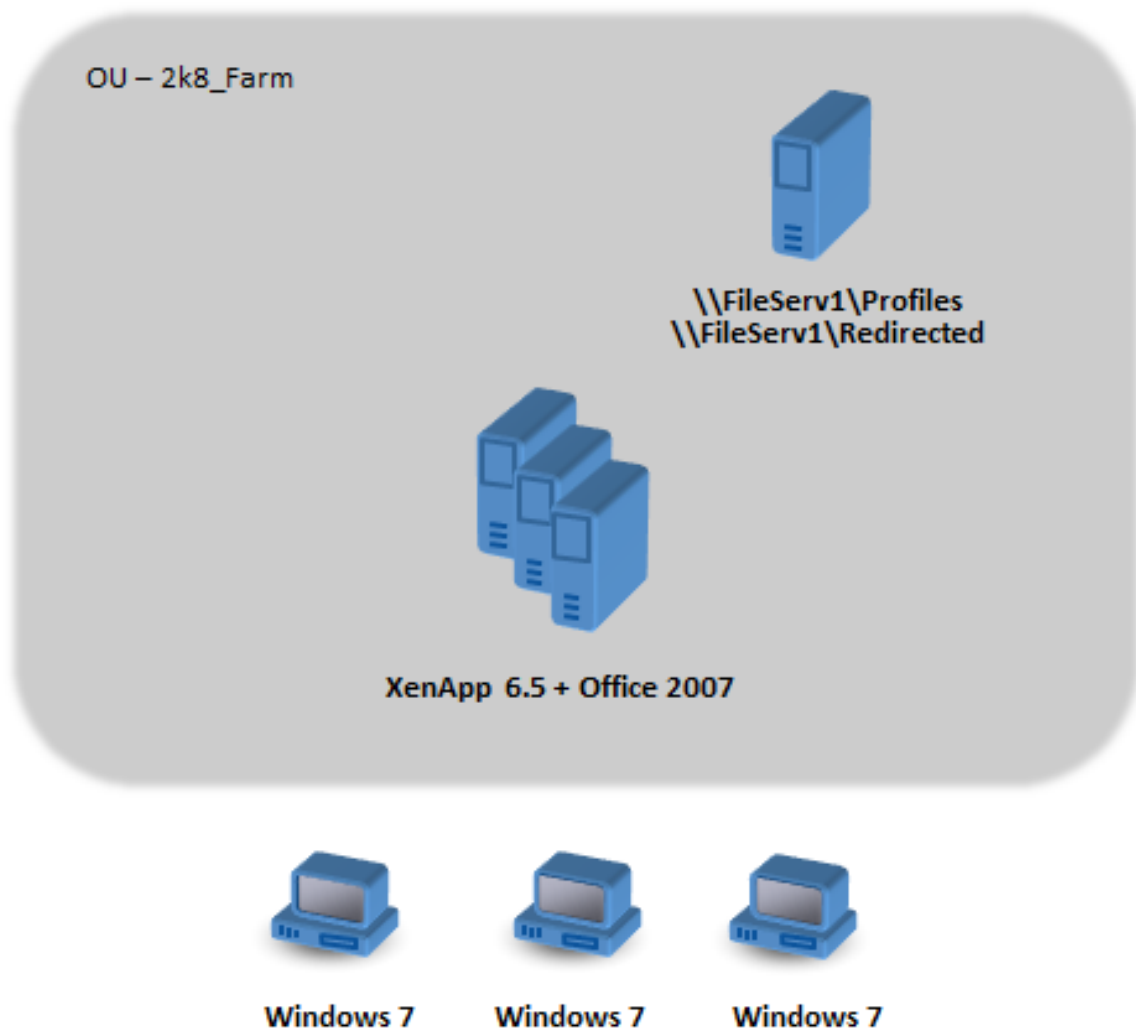

Windows 7 machines are configured to use Office 2007 published on Citrix XenApp 6.5.

The domain includes Windows 2008 domain controllers running Active Directory at Windows 2008 level. All the machines belong to an OU called 2k8_Farm and the Profile Management 5.0 .adm file is added to a GPO called 2k8_Farm_PO. The following policies are configured.

Policy	Value
Path to user store	\FileServ1\Profiles#sAMAccountName#\%ProfVer%
Profile streaming	Enabled
Active write back	Enabled

A machine logon script, which sets the system environment variable %ProfVer%, runs on all machines in the OU.

Machine Type	%ProfVer%
XenApp server on Windows 2008	Win2008
Windows 7 desktops	Win7

So, for example, user john.smith has a profile at \\FileServ1\Profiles\john.smith\Win7 for the Windows 7 desktop and at \\FileServ1\Profiles\john.smith\Win2008 for the Citrix virtual apps servers. Separate profiles are maintained for desktops and servers. The administrator is aware that issues exist when profiles roam between workstation and multi-session operating systems and is being cautious.

Folder redirection is set up using Group Policy in **User Configuration > Policies > Windows Settings > Folder Redirection**.

Plan the new site

August 6, 2024

The network administrators have decided to set up a new domain for the new environment, based on Windows Server 2012 domain controllers and Active Directory 2012. Ultimately, a new virtual apps site is planned, based on Windows Server 2012 running virtual apps. But for now, the new domain is used only for the Windows 7 virtual desktops site.

The site is based on a shared Windows 7 base image that is hosted in a XenServer (formerly Citrix Hypervisor) environment and accessed by Windows terminals. Office 2007 is included in the base image.

Because users from both domains are expected to use the new domain, a two-way trust is set up between OldDomain and NewDomain. Both domains must belong to the same AD forest.

The following graphic illustrates the configuration of the new virtual desktops site.

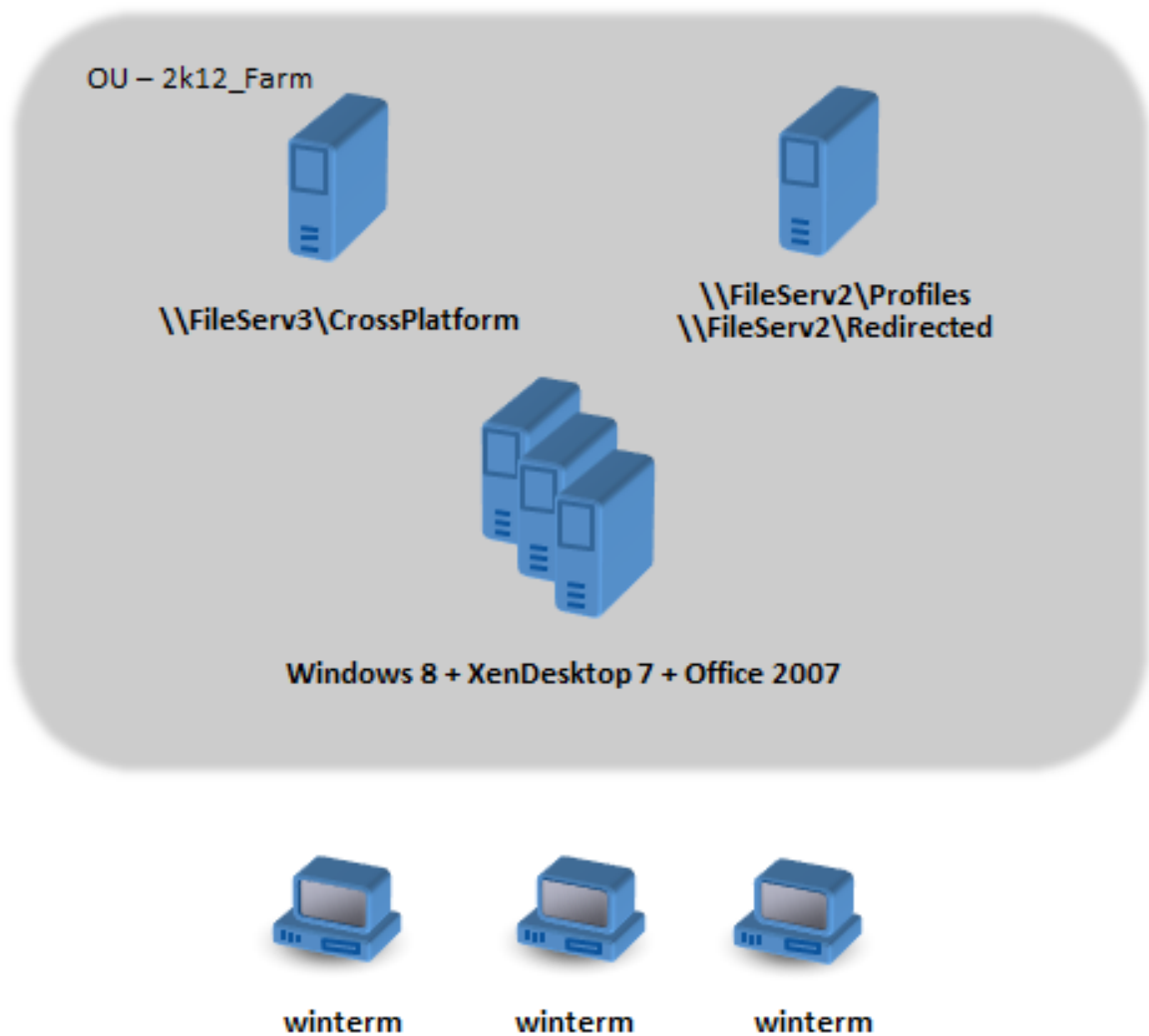

Execute the plan

August 6, 2024

Phase 1: Configure the new file servers

You set up file servers in NewDomain for managing cross-platform settings (\\FileServ3) and for storing profiles for 2k12_Farm (\\FileServ2).

In this case, we choose to set up separate file servers for the profiles and for the cross-platform settings. This way is not strictly necessary, but it is an easy way of making the cross-platform settings server

available. The profile server might be designed differently, using DFS namespaces for example, and so take longer to implement.

In both cases, set up the server shares according to the security recommendations for roaming user profiles on shared folders. For more information, see <https://docs.microsoft.com/en-us/windows-server/storage/folder-redirect/deploy-roaming-user-profiles>.

Phase 2: Upgrade the machines in 2k8_Farm to Profile Management 5.0

For instructions, see [Upgrade Profile Management](#).

Phase 3: Choose which definition files to deploy

Some configuration files (called definition files) are supplied for Microsoft Office, Internet Explorer, and Windows wallpaper.

Important: Do not update these files unless instructed to by Citrix personnel.

Choose the configuration files that are relevant to your deployment, and copy only these files to \\File-Serv3\CrossPlatform\Definitions. In this example, copy just Office 2007.xml.

Phase 4: Configure the machines in 2k8_Farm for Profile Management 5.0

Once the upgrade is complete, make the following configuration changes to (partially) enable the cross-platform settings feature. At this stage, only \\FileServ3\CrossPlatform needs to be available.

Policy	Value	Notes
Path to user store	\\FileServ1\Profiles#sAMAccountName#\%ProfileVer%	This path is only used by OldDomain users, so there is no need to change it to support NewDomain users.
Enable cross-platform settings	Enabled	
Cross-platform settings user groups	Disabled	All user groups are processed.
Path to cross-platform definitions	\\FileServ3\CrossPlatform\Definitions	This path is where the definition files are located.

Policy	Value	Notes
Path to cross-platform settings store	\FileServ3\CrossPlatform\Store\%USERDOMAIN%\CrossPlatform\%USERDOMAIN%	The cross-platform settings store is shared by users of both domains, so both %USERNAME% and %USERDOMAIN% must be specified in the path.
Source for creating cross-platform settings	Enabled	Ensures that cross-platform settings from OldDomain are used to initialize the cross-platform settings store, before giving users access to NewDomain resources.

No changes are required to the machine logon script.

No changes are required to the folder redirection policy.

The OU [2k8_Farm](#) can now be left to run. As users log on, Profile Management copies the settings identified in the definition file Office 2007.xml to the cross-platform settings store.

Phase 5: Prepare the machines in 2k12_Farm

Now that the file servers are set up in [2k8_Farm](#), it is time to build the Citrix virtual desktops site. Install Profile Management 5.0 when the Windows 7 virtual desktops are running. Here is a suitable configuration.

Policy	Value	Notes
Path to user store	\FileServ2\Profiles\%USERDOMAIN%\%Profile%\%USERDOMAIN%\%Profile%	As the user store is shared by users from both domains, it is important also to include domain information.
Active write back	Disabled	
Enable cross-platform settings	Enabled	
Cross-platform settings user groups	Disabled	All user groups are processed.

Policy	Value	Notes
Path to cross-platform definitions	\\FileServ3\CrossPlatform\Definitions	This path is where the definition files are located. This setting must match the setting in 2k8_Farm .
Path to cross-platform settings store	\\FileServ3\CrossPlatform\Store\%USERNAME%\%USERDOMAIN%	Specifies the path to the cross-platform settings store, so both %USERNAME% and %USERDOMAIN% must be specified in the path. This setting must match the setting in 2k8_Farm .
Source for creating cross-platform settings	Disabled	Prevents settings from NewDomain being used for the initial setup of the profile data in the cross-platform settings store. It ensures that settings from OldDomain take precedence.

A machine logon script, which sets the system environment variable %ProfVer%, runs on all machines in the OU.

Machine Type	%ProfVer%	Notes
XenApp server on Windows 2012	Win2012x64	It is required when your planned 64-bit servers become available. See Other considerations for more information.
Windows 7 desktops	Win7	If both 32-bit and 64-bit versions of Windows 7 are deployed, it is recommended that they have separate profiles. So %ProfVer% must be configured differently on each platform.

So the OldDomain user john.smith has a profile at \\FileServ2\Profiles\ john.smith.

OldDomain\Win7 for the Windows 7 desktop and at \\FileServ2\Profiles\john.smith.OldDomain\Win2012x64 for the Citrix virtual apps servers.

And a NewDomain user william.brown has a profile at \\FileServ2\Profiles\william.brown.NewDomain\Win7 for the Windows 7 desktop and at \\FileServ2\Profiles\william.brown.NewDomain\Win2012x64 for the XenApp servers.

Again, you set up folder redirection using Group Policy. Because the domain is based on Windows Server 2012, set folder redirection from **<Group Policy Object Name> > User Configuration > Policies > Windows Settings > Folder Redirection.**

Policy	Value
Favorites	\\FileServ2\Redirected\%USERNAME%.%USERDOMAIN%\Favo
My Documents	\\FileServ2\Redirected\%USERNAME%.%USERDOMAIN%\Docu

%USERDOMAIN% has been added to the folder redirection path. This setup is not necessary because this policy only applies to NewDomain users. But it might be useful if in the future, you decide to migrate OldDomain users to the same server. For now, OldDomain users continue to use the Folder Redirection policy from OldDomain which redirects their folders to \\FileServ1.

Phase 6: Live testing

You perform testing in two stages:

1. You test that the profile data for users from NewDomain operates correctly. These users have no data set up in the cross-platform settings store. As the policy Source for creating cross-platform settings is set to disabled, their profile changes do not propagate to OldDomain.
2. You test with a few users from OldDomain. When they first log on, the cross-platform settings data is copied to their profile. For later logons, changes from either domain are copied to the other. If a user from OldDomain logs on to NewDomain and no profile data is present (because the user has not used their profile in OldDomain since OldDomain was upgraded to Profile Management 5.0), the cross-platform settings store is not updated. With the configuration described in this topic, a user must log on to OldDomain before their settings roam between the domains. This way ensures that user settings (possibly created over many years) are not overwritten by default settings from NewDomain.

Other considerations

August 6, 2024

As configured in this case study, Profile Management does not use the settings from NewDomain to initialize the cross-platform settings store. Only settings from OldDomain can be used to initialize the store. It is acceptable until NewDomain contains more than one type of profile (such as Windows 7 32-bit and Windows 7 64-bit). Alternatively, users from NewDomain might need to access resources in OldDomain. In these cases, you must enable the policy Source for creating cross-platform settings on further types of machine appropriately.

Caution:

If

Source for creating cross-platform settings is set incorrectly, it is possible that a new profile obliterates an existing profile with many accumulated and treasured settings. So we recommend that this policy is set on only one platform type at a time. This platform is generally the older (more mature) platform, where settings that users most likely want to keep have accumulated.

In this case study, separate domains are used to illustrate some points. Also, the cross-platform settings feature can manage the roaming of settings between two OUs, or even between machines of different types in a single OU. In this case, you might have to set the policy Source for creating cross-platform settings differently for the different machine types. This setup can be achieved in several ways:

- Use the setting CPMigrationsFromBaseProfileToCPStore in the .ini file to set the policy differently on each machine type. Do not set the policy Source for creating cross-platform settings.
- Use Windows Management Instrumentation (WMI) filtering to manage different GPOs on the same OU. You can configure the common settings in a GPO that applies to all machines in the OU. But you add only the policy Source for creating cross-platform settings to additional GPOs and filter using a WMI query.

Enable application profiler

August 6, 2024

This feature defines application-based profile handling. When you enable this feature, only the settings defined in the definition file are synchronized.

To enable the application profiler, do the following:

1. Under **Profile Management**, open the **Citrix Virtual Apps Optimization settings** folder.
2. Enable the **Enable Citrix Virtual Apps Optimization** policy.
3. Enable the **Path to Citrix Virtual Apps optimization definitions** policy.
4. Specify a folder where the definition files of Citrix virtual apps optimization are located.
5. Run the `gpupdate /force` command to enforce policy deployment.

Note:

For information about creating definition files, see [Create a definition file](#).

During logoff, only settings in the definition file are synchronized, all other settings are discarded. Use folder redirection in case you want to view or update user documents in the session. For configuring folder redirection, see [Configure folder redirection](#).

Force user logoffs

August 6, 2024

By default, users are given a temporary profile if a problem is encountered (for example, the user store is unavailable). However, you can instead configure Profile Management to display an error message and then log users off. The error message can help with troubleshooting.

1. Under **Profile Management**, open the **Advanced settings** folder.
2. Double-click the **Log off user if a problem is encountered** policy.
3. Select **Enabled**.

Synchronize file security attributes

August 6, 2024

Security attributes can be synchronized when Profile Management copies files and folders in a user profile between the system on which the profile is installed and the user store. This feature aims to prevent inconsistencies among security attributes. It requires Windows 10 and later, and in Windows Server 2016.

This feature is enabled by default. To disable it, do the following:

1. In the **UPMPolicyDefaults_all.ini** file, add **SecurityPreserveEnabled=0** in the **General Settings** section.
2. From a command line, run the `gpupdate /force` command.

Profile Management synchronizes profile changes based on the latest modification time of the profile. Profile Management does not synchronize a file if the changes are made only to the file's security attributes.

Enable asynchronous processing for user Group Policy on logon

August 6, 2024

Windows provides two processing modes for user Group Policy: synchronous and asynchronous. Windows uses a registry value to determine the processing mode for the next user logon. If the registry value doesn't exist, synchronous mode is applied.

The registry value is a machine-level setting and doesn't roam with users. Thus, asynchronous mode is not applied as expected if users:

- Log on to different machines.
- Log on to the same machine where the Delete locally cached profiles on logoff policy is enabled.

Citrix Profile Management provides the **Enable asynchronous processing for user Group Policy on logon** policy to resolve this issue. With this policy enabled, Profile Management roams the registry value with users. As a result, the actual processing mode is applied each time users log on.

This feature applies to both Windows and Windows Server OSs.

Prerequisites

For asynchronous mode to take effect on Windows machines, you don't need to take any additional actions. However, for this mode to take effect on Windows Server machines, make sure that they meet the following requirements:

- Have the Remote Desktop Session Host role installed.
- Have the Group Policies set as follows:
 - **Computer Config > Admin Templates > System > Logon > Always wait for the network at computer startup and logon:** Disabled
 - **Computer Config > Admin Templates > System > Group Policy > Allow asynchronous user Group Policy processing when logging on through Remote Desktop Services:** Enabled

Enable the policy

Follow these steps to enable the policy:

1. Open the Group Policy Management Editor, and then access **Policies > Administrative Templates: Policy definitions (ADMX files) > Citrix Components > Profile Management**.
2. Under Profile Management, click **Advanced settings**.
3. Double-click the **Enable asynchronous processing for user Group Policy on logon** policy.
4. Select **Enabled**.
5. Click **OK**.

For your changes to take effect, run the `gpupdate /force` command from the command prompt. Log off from all sessions and then log on again. For details, see <https://docs.microsoft.com/en-us/windows-server/administration/windows-commands/gpupdate>.

Configuration precedence:

1. If this setting isn't configured here, the corresponding setting from the .ini file is used.
2. If this setting is neither configured here nor in the .ini file, the policy is disabled.

Profile Management policies

August 6, 2024

This article describes important aspects of the policies in the .adm and .admx files.

Profile Management variables

In this version of Profile Management, the following variables are available for use in both Group Policy and the .ini file.

For policies that define files and registry entries, the following variables expand as follows:

Variable	Expansion for Version 1 profiles	Expansion for Version
<code>!ctx_localsettings!</code>	Local Settings\Application Data	AppData\Local
<code>!ctx_roamingappdata!</code>	Application Data	AppData\Roaming
<code>!ctx_startmenu!</code>	Start Menu	AppData\Roaming
<code>!ctx_internetcache!</code>	Local Settings\Temporary Internet Files	AppData\Local\M

Variable	Expansion for Version 1 profiles	Expansion for Version
!ctx_localappdata!	Local Settings\Application Data	AppData\Local

For policies that are used to build paths, the !ctx_osbitness! variable expands to x86 or x64 depending on the operating system. The following variables also expand:

- !ctx_osname! expands to the short name as follows depending on the operating system.
- !ctx_profilever! expands to the profile version as follows depending on the operating system.

The long name is written to the log files when the Profile Management Service starts.

Long Name	Short Name	Profile Version
Windows 11	Win11	v6
Windows 10 Redstone 6	Win10RS6	v6
Windows 10 Redstone 5	Win10RS5	v6
Windows 10 Redstone 4	Win10RS4	v6
Windows 10 Redstone 3	Win10RS3	v6
Windows 10 Redstone 2	Win10RS2	v6
Windows 10 Redstone 1	Win10RS1	v6
Windows 10	Win10	v5
Windows 8.1	Win8.1	v4 or v2
Windows 8	Win8	v3 or v2
Windows 7	Win7	v2
Windows Server 2022	Win2022	v6
Windows Server 2019	Win2019	v6
Windows Server 2016	Win2016	v6
Windows Server 2012 R2	Win2012R2	v4 or v2
Windows Server 2012	Win2012	v3 or v2
Windows Server 2008 R2	Win2008 R2	v1
Windows Server 2008	Win2008	v1

Long Name	Short Name	Profile Version
-----------	------------	-----------------

Note:

For Windows 10 starting with 20H1, the long name is Windows10 <postfix>, and the corresponding short name is Win10_<postfix>. The <postfix> value is obtained from two specific registry entries:

- Entry: HKLM\Software\Microsoft\Windows NT\CurrentVersion > Value Name: DisplayVersion
- Entry: HKLM\Software\Microsoft\Windows NT\CurrentVersion > Value Name: ReleaseId

If the first registry entry contains a value, it is used as the <postfix>. Otherwise, the value from the second registry entry is used.

For Windows 8, Windows 8.1, Windows Server 2012, and Windows Server 2012R2, the actual profile version might change depending on the setting of the `UseProfilePathExtensionVersion` registry key under `HLKM\System\CurrentControlset\Services\ProfSvc\Parameters`:

- If it's set to 1, the profile version is v3 or v4 depending on the operating system.
- If it's not set or set to 0, the profile version is v2.

Policies by version

As an aid to migration, the following tables show the policies that are available in different versions of Profile Management, the location of each policy in the .adm (or .admx) file and in the .ini file, and the feature each policy is designed for (or whether it is part of the base configuration of all deployments).

The location in the .adm or .admx file is relative to `Citrix > Profile Management`.

Policies available from Version 2311

Policy in .adm or .admx file	Location in .adm or .admx file	Policy in .ini file	Feature
SelectBestPerfUS	\AdvancedSettings	SelectBestPerfUS	User store selection method
SharedStoreProfileContainFileDuplication	\FileDuplication	SharedStoreProfileContainFileDuplication	File Duplication

Policy in .adm or .admx file	Location in .adm or .admx file	Policy in .ini file	Feature
PreventLoginWhenProfileContainerMountFailed	ProfileContainerSettings	PreventLoginWhenProfileContainerMountFailed	Logoff user when a failed profile container is not available during logon
GroupsToAccessProfileContainer	ProfileContainerSettings	GroupsToAccessProfileContainer	Users and groups to access profile container

Policies available from Version 2308

Policy in .adm or .admx file	Location in .adm or .admx file	Policy in .ini file	Feature
AutoExtend	\ProfileContainerSettings	AutoExtend	Enable VHD auto-expansion for profile container
AutoExtendThreshold	\AdvancedSettings	AutoExtendThreshold	Profile container auto-expansion threshold
AutoExtendSize	\AdvancedSettings	AutoExtendSize	Profile container auto-expansion increment
AutoExtendLimit	\AdvancedSettings	AutoExtendLimit	Profile container auto-expansion limit
VhdCapacity	\AdvancedSettings	VhdCapacity	Default capacity of VHD containers
DisableConcurrentAccessToProfileContainers	ProfileContainerSettings	DisableConcurrentAccessToProfileContainers	Enable container access to VHD containers
DisableConcurrentAccessToProfileContainers	ProfileContainerSettings	DisableConcurrentAccessToProfileContainers	Enable device container access to VHD containers
EnableUwpAppsRoaming	\AdvancedSettings	EnableUwpAppsRoaming	UWP app roaming

Policies available from Version 2305

Policy in .adm or .admx file	Location in .adm or .admx file	Policy in .ini file	Feature
UserGroupLevelConfigEnabled	\AdvancedSettings	UserGroupLevelConfigEnabled	Enable user-level policy settings
OrderedGroups	\AdvancedSettings	OrderedGroups	Set priority order for user groups

Policies available from Version 2303

Policy in .adm or .admx file	Location in .adm or .admx file	Policy in .ini file	Feature
PSMidSessionWriteBackSessionSettings	\BasicSettings	PSMidSessionWriteBackSessionSettings	Enable active write-back on session lock and disconnection
AppAccessControl	\AppAccessControl	AppAccessControl	Enable app access control
EnableVHDDiskCompaction	\ProfileContainerSettings	EnableVHDDiskCompaction	Enable VHD disk compaction
FreeRatio4Compaction	\AdvancedSettings	FreeRatio4Compaction	Free space ratio to trigger VHD disk compaction
NLogoffs4Compaction	\AdvancedSettings	NLogoffs4Compaction	Number of logoffs to trigger VHD disk compaction
NDefrag4Compaction	\AdvancedSettings	NDefrag4Compaction	Disable defragmentation for VHD disk compaction

Policies available from Version 2209

Policy in .adm or .admx file	Location in .adm or .admx file	Policy in .ini file	Feature
SharedStoreFileInclusionList	\File deduplication	SharedStoreFileInclusionList	Files to include in the shared store for deduplication

Policy in .adm or .admx file	Location in .adm or .admx file	Policy in .ini file	Feature
SharedStoreFileExclusionList	File deduplication	SharedStoreFileExclusionList	Files to exclude from the shared store

Policies available from Version 2206

Policy in .adm or .admx file	Location in .adm or .admx file	Policy in .ini file	Feature
SyncGpoStateEnabled	\AdvancedSettings	SyncGpoStateEnabled	Enable asynchronous processing for user Group Policy on logon
OneDriveContainer	\AdvancedSettings	OneDriveContainer	Enable the roaming OneDrive folders
OutlookSearchRoamingConcurrentSessionsEnabled	\AdvancedSettings	OutlookSearchRoamingConcurrentSessionsEnabled	Enable Outlook search data roaming in concurrent sessions
PSForPendingAreaEnabled	Streamed user profiles	PSForPendingAreaEnabled	Enable profile streaming for pending area

Policies available from Version 2203

Policy in .adm or .admx file	Location in .adm or .admx file	Policy in .ini file	Feature
EnableVolumeReattach	\AdvancedSettings	EnableVolumeReattach	Automatically reattach VHDX disks in sessions

Policies available from Version 2112

Policy in .adm or .admx file	Location in .adm or .admx file	Policy in .ini file	Feature
ProfileContainerExclusionList	Profile container settings	ProfileContainerExclusionList	Exclude files from the profile container

Policy in .adm or .admx file	Location in .adm or .admx file	Policy in .ini file	Feature
ProfileContainerInclusionList	ProfileContainer settings	ProfileContainerInclusionList	Include files in the profile container
VhdStorePath	AdvancedSettings	PathToVhdStore	Specify a network storage location for VHDX files

Policies available from Version 2109

Policy in .adm or .admx file	Location in .adm or .admx file	Policy in .ini file	Feature
CredBasedAccessEnabled	AdvancedSettings	CredBasedAccessEnabled	Enable credential-based access to user stores

Policies available from Version 2106

Policy in .adm or .admx file	Location in .adm or .admx file	Policy in .ini file	Feature
AccelerateFolderMirroring	FileSystemSettings\FSSync	AccelerateFolderMirroring	Accelerate folder mirroring
CredBasedAccessEnabled	AdvancedSettings	CredBasedAccessEnabled	Enable credential-based access to user store
MultiSiteReplication	AdvancedSettings	MultiSiteReplication	Replicate user stores

Policies available from Version 2103

Policy in .adm or .admx file	Location in .adm or .admx file	Policy in .ini file	Feature
PSForFoldersEnabled	\PsSettings	PSForFoldersEnabled	Profile streaming for folders
ProfileContainerLocalCache	ProfileContainerSettings	ProfileContainerLocalCache	Local caching for profile containers

Policies available from Version 2009

Policy in .adm or .admx file	Location in .adm or .admx file	Policy in .ini file	Feature
ProfileContainerExclusion	ProfileContainerSettings	ProfileContainerExclusion	Profile container
ProfileContainerInclusion	ProfileContainerSettings	ProfileContainerInclusion	Profile container

Policy available from Version 2003

Policy in .adm or .admx file	Location in .adm or .admx file	Policy in .ini file	Feature
FSLogixProfileContainerSupport	AdvancedSettings	FSLogixProfileContainerSupport	Before Version 2103: Enable multi-session write-back for FSLogix Profile Container Version 2103 and later: Enable multi-session write-back for Profile Containers

Policies available from Version 1909

Policy in .adm or .admx file	Location in .adm or .admx file	Policy in .ini file	Feature
MigrateUserStore	\	MigrateUserStore	Migrate UserStore
OutlookEdbBackupEnabled	AdvancedSettings	OutlookEdbBackupEnabled	Outlook search index database - backup and restore
ApplicationProfilesAutoMigration	AdvancedSettings	ApplicationProfilesAutoMigration	Automatic migration of existing application profiles

Policy available from Version 1903

Policy in .adm or .admx file	Location in .adm or .admx file	Policy in .ini file	Feature
ProfileContainer	Before Version 2009: \FileSystemSet- tings\FSSynchronization Version 2009 and later: \ProfileContainer	ProfileContainer	Profile Container

Policy available from Version 7.18

Policy in .adm or .admx file	Location in .adm or .admx file	Policy in .ini file	Feature
OutlookSearchRoamingEnabled	AdvancedSettings	OutlookSearchRoamingEnabled	Outlook search roaming

Policies available from Version 7.16

Policy in .adm or .admx file	Location in .adm or .admx file	Policy in .ini file	Feature
XenAppOptimizationSettings	XenAppOptimizationSettings	XenAppOptimizationSettings	Citrix Virtual Apps and Desktops application optimization
XenAppOptimizationDefinition	XenAppOptimizationSettings	XenAppOptimizationDefinition	Citrix Virtual Apps and Desktops application optimization
LargeFileHandlingList	\FileSystemSettings	LargeFileHandlingList	Large file handling

Policy available from Version 7.15

Policy in .adm or .admx file	Location in .adm or .admx file	Policy in .ini file	Feature
LogonExclusionCheck	\FileSystemSettings	LogonExclusionCheck	Logon exclusion check

Policy available from Version 5.8

Policy in .adm or .admx file	Location in .adm or .admx file	Policy in .ini file	Feature
StreamingExclusionList	\PsSettings	StreamingExclusionList	Profile streaming exclusion list

Policies available from Version 5.6

Policy in .adm or .admx file	Location in .adm or .admx file	Policy in .ini file	Feature
CEIPEnabled	\AdvancedSettings	CEIPEnabled	CEIP
PSMidSessionWriteBackReg	\Reg	PSMidSessionWriteBackReg	Active write back registry

Policies available from Version 5.5

Policy in .adm or .admx file	Location in .adm or .admx file	Policy in .ini file	Feature
Default Exclusion list	\Registry	DefaultExclusionListRegistry	Base
NTUSER.DAT	\Registry	LastKnownGoodRegistry	Backup NTUSER.DAT
Default Exclusion list - directories	\File system	DefaultSyncExclusionListDir	Base

Policies available from Version 5.0–5.4

Policy in .adm or .admx file	Location in .adm or .admx file	Policy in .ini file	Feature
Excluded groups	\	ExcludedGroups	Excluded Groups
Disable automatic configuration	\Advanced Settings	DisableDynamicConfig	Automatic Configuration

Policy in .adm or .admx file	Location in .adm or .admx file	Policy in .ini file	Feature
Redirect the AppData (Roaming) folder, Redirect the Desktop folder, ...	\Folder Redirection (in User Configuration)	Note: Not applicable	Integration with XenDesktop
Delay before deleting cached profiles	\Profile handling	ProfileDeleteDelay	Base

Policies available from Version 4.x

Policy in .adm or .admx file	Location in .adm or .admx file	Policy in .ini file	Feature
Cross-platform settings user groups	\Cross-platform settings	CPUserGroupList	Cross-platform settings
Enable cross-platform settings	\Cross-platform settings	CPEnabled	Cross-platform settings
Source for creating cross-platform settings	\Cross-platform settings	CPMigrationFromBaseProfileToCrossPlatform	Cross-platform settings
Path to cross-platform definitions	\Cross-platform settings	CPSchemaPath	Cross-platform settings
Path to cross-platform settings store	\Cross-platform settings	CPPath	Cross-platform settings
Offline profile support	\Cross-platform settings	OfflineSupport	Offline profiles
Log off user if a problem is encountered	\Advanced Settings	LogoffRatherThanTempProfile	Improved Troubleshooting

Policies available from Version 3.x

Policy in .adm or .admx file	Location in .adm or .admx file	Policy in .ini file	Feature
Active write back	\	PSMidSessionWriteBack	Active profile writeback (in Version 4.0, renamed Active write back)
Folders to mirror (available from Version 3.1)	\File system\Synchronization	MirrorFoldersList	Folder mirroring
Process Internet cookie files on logoff (available from Version 3.1)	\Advanced settings	ProcessCookieFiles	Folder mirroring
Delete Redirected Folders (available in Versions 3.2, 3.2.2, and 4.0)	\Advanced settings	DeleteRedirectedFolders	Support for folder redirection
Always cache	\Streamed user profiles	PSAlwaysCache	Streamed user profiles
Profile streaming	\Streamed user profiles	PSEnabled	Streamed user profiles
Timeout for pending area lock files	\Streamed user profiles	PSPendingLockTimeout	Streamed user profiles
Streamed user profile groups	\Streamed user profiles	PSUserGroupsList	Streamed user profiles

Policies available from Version 2.x

Policy in .adm or .admx file	Location in .adm or .admx file	Policy in .ini file	Feature
Path to user store	\	PathToUserStore	Base
Processed groups	\	ProcessedGroups	Base
Local profile conflict handling	\Profile handling	LocalProfileConflictHandling	Base
Migration of existing profiles	\Profile handling	MigrateWindowsProfilesToUserStore	Base

Policy in .adm or .admx file	Location in .adm or .admx file	Policy in .ini file	Feature
Template profile	\Profile handling	TemplateProfilePath, TemplateProfileOver-ridesRoamingProfile, TemplateProfileOver-ridesLocalProfile	Base
Delete locally cached profiles on logoff	\Profile handling	DeleteCachedProfilesOnLogoff	Base
Directory of the MFT cache file (removed in Version 5.0)	\Advanced settings	USNDBPath	Base
Directories to synchronize	\File system\Synchronization	SyncDirList	Base
Exclusion list	\Registry	ExclusionListRegistry	Base
Files to synchronize	\File system\Synchronization	SyncFileList	Base
Inclusion list	\Registry	InclusionListRegistry	Base
Exclusion list - directories	\File system	SyncExclusionListDir	Base
Exclusion list - files	\File system	SyncExclusionListFiles	Base
Number of retries when accessing locked files	\Advanced settings	LoadRetries	Base
Process logons of local administrators	\	ProcessAdmin	Base
Enable Profile Management	\	ServiceActive	Base
Enable logging	\Log settings	LoggingEnabled	Logging
Log settings	\Log settings	LogLevel	Logging
Maximum size of the log file	\Log settings	MaxLogSize	Logging
Path to log file (available from Version 2.1)	\Log settings	PathToLogFile	Logging

Profile Management policies

August 6, 2024

This article describes important aspects of the policies in the .adm and .admx files.

Profile Management variables

In this version of Profile Management, the following variables are available for use in both Group Policy and the .ini file.

For policies that define files and registry entries, the following variables expand as follows:

Variable	Expansion for Version 1 profiles	Expansion for Version
!ctx_localsettings!	Local Settings\Application Data	AppData\Local
!ctx_roamingappdata!	Application Data	AppData\Roaming
!ctx_startmenu!	Start Menu	AppData\Roaming
!ctx_internetcache!	Local Settings\Temporary Internet Files	AppData\Local\M
!ctx_localappdata!	Local Settings\Application Data	AppData\Local

For policies that are used to build paths, the !ctx_osbitness! variable expands to x86 or x64 depending on the operating system. The following variables also expand:

- !ctx_osname! expands to the short name as follows depending on the operating system.
- !ctx_profilever! expands to the profile version as follows depending on the operating system.

The long name is written to the log files when the Profile Management Service starts.

Long Name	Short Name	Profile Version
Windows 11	Win11	v6
Windows 10 Redstone 6	Win10RS6	v6
Windows 10 Redstone 5	Win10RS5	v6
Windows 10 Redstone 4	Win10RS4	v6
Windows 10 Redstone 3	Win10RS3	v6

Long Name	Short Name	Profile Version
Windows 10 Redstone 2	Win10RS2	v6
Windows 10 Redstone 1	Win10RS1	v6
Windows 10	Win10	v5
Windows 8.1	Win8.1	v4 or v2
Windows 8	Win8	v3 or v2
Windows 7	Win7	v2
Windows Server 2022	Win2022	v6
Windows Server 2019	Win2019	v6
Windows Server 2016	Win2016	v6
Windows Server 2012 R2	Win2012R2	v4 or v2
Windows Server 2012	Win2012	v3 or v2
Windows Server 2008 R2	Win2008	v1
Windows Server 2008	Win2008	v1

Note:

For Windows 10 starting with 20H1, the long name is Windows10 <postfix>, and the corresponding short name is Win10_<postfix>. The <postfix> value is obtained from two specific registry entries:

- Entry: HKLM\Software\Microsoft\Windows NT\CurrentVersion > Value Name: DisplayVersion
- Entry: HKLM\Software\Microsoft\Windows NT\CurrentVersion > Value Name: ReleaseId

If the first registry entry contains a value, it is used as the <postfix>. Otherwise, the value from the second registry entry is used.

For Windows 8, Windows 8.1, Windows Server 2012, and Windows Server 2012R2, the actual profile version might change depending on the setting of the `UseProfilePathExtensionVersion` registry key under `HLKM\System\CurrentControlset\Services\ProfSvc\Parameters`:

- If it's set to 1, the profile version is v3 or v4 depending on the operating system.

- If it's not set or set to 0, the profile version is v2.

Policies by version

As an aid to migration, the following tables show the policies that are available in different versions of Profile Management, the location of each policy in the .adm (or .admx) file and in the .ini file, and the feature each policy is designed for (or whether it is part of the base configuration of all deployments).

The location in the .adm or .admx file is relative to [Citrix > Profile Management](#).

Policies available from Version 2311

Policy in .adm or .admx file	Location in .adm or .admx file	Policy in .ini file	Feature
SelectBestPerfUS	\AdvancedSettings	SelectBestPerfUS	User store selection method
SharedStoreProfileContainerFileDuplication	\AdvancedSettings	SharedStoreProfileContainerFileDuplication	File Duplication
PreventLoginWhenProfileContainerSettings	\ProfileContainerSettings	PreventLoginWhenProfileContainerSettings	Logoff if profile container is not available during logon
GroupsToAccessProfileContainer	\ProfileContainerSettings	GroupsToAccessProfileContainer	Users and groups to access profile container

Policies available from Version 2308

Policy in .adm or .admx file	Location in .adm or .admx file	Policy in .ini file	Feature
AutoExtend	\ProfileContainerSettings	AutoExtend	Enable VHD auto-expansion for profile container
AutoExtendThreshold	\AdvancedSettings	AutoExtendThreshold	Profile container auto-expansion threshold
AutoExtendSize	\AdvancedSettings	AutoExtendSize	Profile container auto-expansion increment

Policy in .adm or .adm file	Location in .adm or .adm file	Policy in .ini file	Feature
AutoExtendLimit	\AdvancedSettings	AutoExtendLimit	Profile container auto-expansion limit
VhdCapacity	\AdvancedSettings	VhdCapacity	Default capacity of VHD containers
DisableConcurrentAccessToProfileContainers	\ProfileContainerSettings	DisableConcurrentAccessToProfileContainers	Enable/disable container access to VHD containers
DisableConcurrentAccessToProfileContainers	\ProfileContainerSettings	DisableConcurrentAccessToProfileContainers	Enable/disable container access to VHD containers
EnableUwpAppsRoaming	\AdvancedSettings	EnableUwpAppsRoaming	UWP app roaming

Policies available from Version 2305

Policy in .adm or .adm file	Location in .adm or .adm file	Policy in .ini file	Feature
UserGroupLevelConfigEnabled	\AdvancedSettings	UserGroupLevelConfigEnabled	Enable user-level policy settings
OrderedGroups	\AdvancedSettings	OrderedGroups	Set priority order for user groups

Policies available from Version 2303

Policy in .adm or .adm file	Location in .adm or .adm file	Policy in .ini file	Feature
PSMidSessionWriteBackSessionLock	\BasicSettings	PSMidSessionWriteBackSessionLock	Enable/disable write-back on session lock and disconnection
AppAccessControl	\AppAccessControl	AppAccessControl	Enable app access control
EnableVHDDiskCompaction	\ProfileContainerSettings	EnableVHDDiskCompaction	Enable VHD disk compaction

Policy in .adm or .admx file	Location in .adm or .admx file	Policy in .ini file	Feature
FreeRatio4Compaction	\AdvancedSettings	FreeRatio4Compaction	Free space ratio to trigger VHD disk compaction
NLogoffs4Compaction	\AdvancedSettings	NLogoffs4Compaction	Number of logoffs to trigger VHD disk compaction
NDefrag4Compaction	\AdvancedSettings	NDefrag4Compaction	Disable defragmentation for VHD disk compaction

Policies available from Version 2209

Policy in .adm or .admx file	Location in .adm or .admx file	Policy in .ini file	Feature
SharedStoreFileInclusionList	\File deduplication	SharedStoreFileInclusionList	Files to include in the shared store for deduplication
SharedStoreFileExclusionList	\File deduplication	SharedStoreFileExclusionList	Files to exclude from the shared store

Policies available from Version 2206

Policy in .adm or .admx file	Location in .adm or .admx file	Policy in .ini file	Feature
SyncGpoStateEnabled	\AdvancedSettings	SyncGpoStateEnabled	Enable asynchronous processing for user Group Policy on logon
OneDriveContainer	\AdvancedSettings	OneDriveContainer	Enable the roaming OneDrive folders
OutlookSearchRoamingConcurrentSessionsEnabled	\AdvancedSettings	OutlookSearchRoamingConcurrentSessionsEnabled	Enable Outlook search data roaming in concurrent sessions

Profile Management 2311

Policy in .adm or .admx file	Location in .adm or .admx file	Policy in .ini file	Feature
PSForPendingAreaEnabled	Streamed user profiles	PSForPendingAreaEnabled	Enable profile streaming for pending area

Policies available from Version 2203

Policy in .adm or .admx file	Location in .adm or .admx file	Policy in .ini file	Feature
EnableVolumeReattach	\AdvancedSettings	EnableVolumeReattach	Automatically reattach VHDX disks in sessions

Policies available from Version 2112

Policy in .adm or .admx file	Location in .adm or .admx file	Policy in .ini file	Feature
ProfileContainerExclusionList	Profile container settings	ProfileContainerExclusionList	Exclude files from the profile container
ProfileContainerInclusionList	Profile container settings	ProfileContainerInclusionList	Include files in the profile container
VhdStorePath	AdvancedSettings	PathToVhdStore	Specify a network storage location for VHDX files

Policies available from Version 2109

Policy in .adm or .admx file	Location in .adm or .admx file	Policy in .ini file	Feature
CredBasedAccessEnabled	AdvancedSettings	CredBasedAccessEnabled	Enable credential-based access to user stores

Policies available from Version 2106

Policy in .adm or .admx file	Location in .adm or .admx file	Policy in .ini file	Feature
AccelerateFolderMirroring	\FileSystemSettings\FSSystemSettings\AccelerateFolderMirroring	AccelerateFolderMirroring	Accelerate folder mirroring
CredBasedAccessEnabled	AdvancedSettings	CredBasedAccessEnabled	Enable credential-based access to user store
MultiSiteReplication	AdvancedSettings	MultiSiteReplication	Replicate user stores

Policies available from Version 2103

Policy in .adm or .admx file	Location in .adm or .admx file	Policy in .ini file	Feature
PSForFoldersEnabled	\PsSettings	PSForFoldersEnabled	Profile streaming for folders
ProfileContainerLocalCache	ProfileContainerSettings	ProfileContainerLocalCache	Local caching for profile containers

Policies available from Version 2009

Policy in .adm or .admx file	Location in .adm or .admx file	Policy in .ini file	Feature
ProfileContainerExclusion	ProfileContainerSettings	ProfileContainerExclusion	Profile container
ProfileContainerInclusion	ProfileContainerSettings	ProfileContainerInclusion	Profile container

Policy available from Version 2003

Policy in .adm or .admx file	Location in .adm or .admx file	Policy in .ini file	Feature
FSLogixProfileContainerSupport	AdvancedSettings	FSLogixProfileContainerSupport	Before Version 2103: Enable multi-session write-back for FSLogix Profile Container Version 2103 and later: Enable multi-session write-back for Profile Containers

Policies available from Version 1909

Policy in .adm or .admx file	Location in .adm or .admx file	Policy in .ini file	Feature
MigrateUserStore	\	MigrateUserStore	Migrate UserStore
OutlookEdbBackupEnabled	AdvancedSettings	OutlookEdbBackupEnabled	Outlook search index database - backup and restore
ApplicationProfilesAutomaticMigration	AdvancedSettings	ApplicationProfilesAutomaticMigration	Automatic migration of existing application profiles

Policy available from Version 1903

Policy in .adm or .admx file	Location in .adm or .admx file	Policy in .ini file	Feature
ProfileContainer	Before Version 2009: \FileSystemSettings\FSSynchronization Version 2009 and later: \ProfileContainer	ProfileContainer	Profile Container

Policy available from Version 7.18

Policy in .adm or .admx file	Location in .adm or .admx file	Policy in .ini file	Feature
OutlookSearchRoamingEnabled	AdvancedSettings	OutlookSearchRoamingEnabled	Outlook search roaming

Policies available from Version 7.16

Policy in .adm or .admx file	Location in .adm or .admx file	Policy in .ini file	Feature
XenAppOptimizationSettings	XenAppOptimizationSettings	XenAppOptimizationSettings	Citrix Virtual Apps and Desktops application optimization
XenAppOptimizationDefinition	XenAppOptimizationSettings	XenAppOptimizationDefinition	Citrix Virtual Apps and Desktops application optimization
LargeFileHandlingList	\FileSystemSettings	LargeFileHandlingList	Large file handling

Policy available from Version 7.15

Policy in .adm or .admx file	Location in .adm or .admx file	Policy in .ini file	Feature
LogonExclusionCheck	\FileSystemSettings	LogonExclusionCheck	Logon exclusion check

Policy available from Version 5.8

Policy in .adm or .admx file	Location in .adm or .admx file	Policy in .ini file	Feature
StreamingExclusionList	\PsSettings	StreamingExclusionList	Profile streaming exclusion list

Policies available from Version 5.6

Policy in .adm or .admx file	Location in .adm or .admx file	Policy in .ini file	Feature
CEIPEnabled	\AdvancedSettings	CEIPEnabled	CEIP
PSMidSessionWriteBackReg		PSMidSessionWriteBackReg	Active write back registry

Policies available from Version 5.5

Policy in .adm or .admx file	Location in .adm or .admx file	Policy in .ini file	Feature
Default Exclusion list NTUSER.DAT	\Registry	DefaultExclusionListRegistry	Base
Default Exclusion list - directories	\Registry	LastKnownGoodRegistry	Backup NTUSER.DAT
	\File system	DefaultSyncExclusionList	Base

Policies available from Version 5.0–5.4

Policy in .adm or .admx file	Location in .adm or .admx file	Policy in .ini file	Feature
Excluded groups	\	ExcludedGroups	Excluded Groups
Disable automatic configuration	\Advanced Settings	DisableDynamicConfig	Automatic Configuration
Redirect the AppData (Roaming) folder, Redirect the Desktop folder, ...	\Folder Redirection (in User Configuration)	Note: Not applicable	Integration with XenDesktop
Delay before deleting cached profiles	\Profile handling	ProfileDeleteDelay	Base

Policies available from Version 4.x

Policy in .adm or .admx file	Location in .adm or .admx file	Policy in .ini file	Feature
Cross-platform settings user groups	\Cross-platform settings	CPUserGroupList	Cross-platform settings
Enable cross-platform settings	\Cross-platform settings	CPEnabled	Cross-platform settings
Source for creating cross-platform settings	\Cross-platform settings	CPMigrationFromBaseProfileToCPPlatform	Cross-platform settings
Path to cross-platform definitions	\Cross-platform settings	CPSchemaPath	Cross-platform settings
Path to cross-platform settings store	\Cross-platform settings	CPPath	Cross-platform settings
Offline profile support	\Cross-platform settings	OfflineSupport	Offline profiles
Log off user if a problem is encountered	\Advanced Settings	LogoffRatherThanTempProfile	Improved Troubleshooting

Policies available from Version 3.x

Policy in .adm or .admx file	Location in .adm or .admx file	Policy in .ini file	Feature
Active write back	\	PSMidSessionWriteBack	Active profile writeback (in Version 4.0, renamed Active write back)
Folders to mirror (available from Version 3.1)	\File system\Synchronization	MirrorFoldersList	Folder mirroring
Process Internet cookie files on logoff (available from Version 3.1)	\Advanced settings	ProcessCookieFiles	Folder mirroring

Policy in .adm or .admx file	Location in .adm or .admx file	Policy in .ini file	Feature
Delete Redirected Folders (available in Versions 3.2, 3.2.2, and 4.0)	\Advanced settings	DeleteRedirectedFolders	Support for folder redirection
Always cache	\Streamed user profiles	PSAlwaysCache	Streamed user profiles
Profile streaming	\Streamed user profiles	PSEnabled	Streamed user profiles
Timeout for pending area lock files	\Streamed user profiles	PSPendingLockTimeout	Streamed user profiles
Streamed user profile groups	\Streamed user profiles	PSUserGroupsList	Streamed user profiles

Policies available from Version 2.x

Policy in .adm or .admx file	Location in .adm or .admx file	Policy in .ini file	Feature
Path to user store	\	PathToUserStore	Base
Processed groups	\	ProcessedGroups	Base
Local profile conflict handling	\Profile handling	LocalProfileConflictHandling	Base
Migration of existing profiles	\Profile handling	MigrateWindowsProfilesToUserStore	Base
Template profile	\Profile handling	TemplateProfilePath, TemplateProfileOverridesRoamingProfile, TemplateProfileOverridesLocalProfile	Base
Delete locally cached profiles on logoff	\Profile handling	DeleteCachedProfilesOnLogoff	Base
Directory of the MFT cache file (removed in Version 5.0)	\Advanced settings	USNDBPath	Base
Directories to synchronize	\File system\Synchronization	SyncDirList	Base

Policy in .adm or .admx file	Location in .adm or .admx file	Policy in .ini file	Feature
Exclusion list	\Registry	ExclusionListRegistry	Base
Files to synchronize	\File system\Synchronization	SyncFileList	Base
Inclusion list	\Registry	InclusionListRegistry	Base
Exclusion list - directories	\File system	SyncExclusionListDir	Base
Exclusion list - files	\File system	SyncExclusionListFiles	Base
Number of retries when accessing locked files	\Advanced settings	LoadRetries	Base
Process logons of local administrators	\	ProcessAdmin	Base
Enable Profile Management	\	ServiceActive	Base
Enable logging	\Log settings	LoggingEnabled	Logging
Log settings	\Log settings	LogLevel	Logging
Maximum size of the log file	\Log settings	MaxLogSize	Logging
Path to log file (available from Version 2.1)	\Log settings	PathToLogFile	Logging

Profile Management policy descriptions and defaults

August 12, 2024

This topic describes the policies in the Profile Management .adm and .admx files.

For more information about the policies, see [Profile Management policies](#).

Sections in the .adm and .admx files

Profile Management policies reside in the following sections:

Profile Management

Profile Management\Folder Redirection (User Configuration)

Profile Management\Profile handling

Profile Management\Advanced settings

Profile Management\Log settings

Profile Management\Registry

Profile Management\File system

Profile Management\File system\Synchronization

Profile Management\File deduplication

Profile Management\Streamed user profiles

Profile Management\Cross-platform settings

In the Group Policy Object Editor, most of the policies appear under **Computer Configuration > Administrative Templates > Classic Administrative Templates > Citrix**. Redirected folder policies appear under **User Configuration > Administrative Templates > Classic Administrative Templates > Citrix**.

In the Group Policy Editor, the policies appear under **Computer Configuration** unless the policies are under the section labeled **User Configuration**.

Profile Management

Enable Profile Management

Lets you enable Profile Management. By default, to ease deployment, Profile Management does not process logons or logoffs. Enable Profile Management only after you do all other setup tasks and test how Citrix user profiles behave in your environment.

Configuration precedence:

1. If this policy isn't configured here, the value from the .ini file is used.
2. If this policy is not configured either here or in the .ini file, Profile Management does not process Windows user profiles in any way.

Processed groups

Lets you specify users whose profiles are processed. Specify users using the following user groups:

- Domain groups (local, global, and universal) in the format of <DOMAIN NAME>\<GROUP NAME>
- Local groups in the format of GROUP NAME

Configuration precedence:

1. If this policy is configured here, Profile Management processes only members of these user groups. If this policy is disabled, Profile Management processes all users.
2. If this policy isn't configured here, the value from the .ini file is used.
3. If this policy is not configured either here or in the .ini file, members of all user groups are processed.

Excluded groups

Lets you specify users whose profiles aren't processed. You can specify users by using the following user groups:

- Domain groups (local, global, and universal) in the format of <DOMAIN NAME>\<GROUP NAME>
- Local groups in the format of GROUP NAME

Configuration precedence:

1. If this setting is configured here, Profile Management excludes members of those user groups.
2. If this setting is disabled, Profile Management does not exclude any users.
3. If this setting isn't configured here, the value from the .ini file is used.
4. If this setting is not configured either here or in the .ini file, no members of any groups are excluded.

Process logons of local administrators

Lets you specify whether Profile Management processes logons of members of the `BUILTIN\Administrators` group. Enabling this policy is recommended for Citrix virtual desktops deployments, in which most users are local administrators.

Citrix virtual apps environments are the typical use cases of multi-session operating systems. If this policy is disabled or not configured on multi-session operating systems, Profile Management processes logons of domain users but not of local administrators. Citrix virtual desktops environments are the typical use cases of single-session operating systems. On single-session operating systems, Profile Management processes local administrator logons.

Domain users with local administrator permissions are typically Citrix virtual desktops users with assigned virtual desktops. When a desktop experiences problems with Profile Management, this policy allows the user to log on by bypassing any logon processing and to troubleshoot the problems.

Note:

Domain users' logons might be subject to restrictions imposed by group membership, typically to ensure compliance with product licensing.

Configuration precedence:

1. If this policy is disabled, Profile Management does not process logons by local administrators.
2. If this policy isn't configured here, the value from the .ini file is used.
3. If this policy is not configured either here or in the .ini file, administrators aren't processed.

Path to user store

Lets you specify the storage path of the user store. The user store is the central network location where user profiles (registry changes and synchronized files) are stored.

The path can be:

- A path relative to the home directory. The home directory is typically configured as the `#homeDirectory#` attribute for a user in the Active Directory.
- A UNC path. It typically specifies a server share or a DFS namespace.
- Disabled or unconfigured. In this case, the path is `#homeDirectory#\Windows`.

The following types of variables can be used in the path setting:

- System environment variables enclosed in percent signs (for example, `%ProfVer%`). System environment variables generally require extra setup.
- Attributes of the Active Directory user object enclosed in hashes (for example, `#sAMAccountName#`).
- Profile Management variables. For more information, see the Profile Management variables product document.

User environment variables cannot be used, except for `%username%` and `%userdomain%`. You can also create custom attributes to define organizational variables such as location or users fully. Attributes are case-sensitive.

Examples:

- `\\server\share\|#sAMAccountName#` stores the user settings to the UNC path `\\server\share\JohnSmith` (if `#sAMAccountName#` resolves to `JohnSmith` for the current user)

- `\\server\profiles$\%USERNAME%.%USERDOMAIN%\!CTX_OSNAME!!CTX_OSBITNESS!
! might expand to \\server\profiles$\JohnSmith.DOMAINCONTROLLER1\
Win8x64`

Important: Whichever attributes or variables you use, check that this policy expands to the folder one level higher than the folder containing NTUSER.DAT. For example, if this file exists in `\server\profiles$\JohnSmith.Finance\Win8x64\UPM_Profile`, set the path to the user store as `\server\profiles$\JohnSmith.Finance\Win8x64` (not the `\UPM_Profile` subfolder).

For more information on using variables when specifying the path to the user store, see the following topics:

- Share Citrix user profiles on several file servers
- Administer profiles within and across OUs
- High availability and disaster recovery with Profile Management

Configuration precedence:

1. If Path to user store is disabled, the user settings are saved in the Windows subdirectory of the home directory. If this policy is disabled, the user settings are saved in the Windows subdirectory of the home directory.
2. If this policy isn't configured here, the value from the .ini file is used.
3. If this policy is not configured either here or in the .ini file, the Windows directory on the home drive is used.

Migrate user store

Lets you specify the storage path of the user store that Profile Management previously used (the [path to user store](#) setting that you previously specified).

If this setting is configured, the user settings stored in the previous user store are migrated to the current user store.

The path can be an absolute UNC path or a path relative to the home directory.

In both cases, you can use the following types of variables:

- System environment variables enclosed in percent signs
- Attributes of the Active Directory user object enclosed in hash signs

Examples:

- If `%ProfileVer%` is a system environment variable that resolves to W2K3, the folder `Windows \ %ProfileVer%` stores the user settings in a subfolder called `Windows \ W2K3` of the user store.

- If #SAMAaccountName# resolves to JohnSmith for the current user, \\server\share\|#SAMAaccountName# stores the user settings to the UNC path \\server\share\<JohnSmith>.

Configuration precedence:

1. In the path, you can use user environment variables except %username% and %userdomain%. If this setting is disabled, the user settings are saved in the current user store.
2. If this setting isn't configured here, the corresponding setting from the .ini file is used.
3. If this setting is not configured either here or in the .ini file, the user settings are saved in the current user store.

Active write back

Lets you enable the active write-back feature. With this feature enabled, Profile Management synchronizes files and folders that are modified on the local computer to the user store during a session.

Configuration precedence:

1. If this policy isn't configured here, the value from the .ini file is used.
2. If this policy is not configured either here or in the .ini file, it is disabled.

Active write back registry

Lets you enable Profile Management to synchronize registry entries that are modified on the local computer to the user store during a session. Use this policy with the **Active write back** policy.

Configuration precedence:

1. If you do not configure this setting here, the value from the .ini file is used.
2. If you configure this setting neither here nor in the .ini file, the active write-back registry is disabled.

Active write back on session lock and disconnection

With both this policy and the **Active write back** policy enabled, profile files and folders are written back only when a session is locked or disconnected.

With this policy and both the **Active write back** and **Active write back registry** policies enabled, registry entries are written back only when a session is locked or disconnected.

Configuration precedence:

- If this setting isn't configured here, the value from the .ini file is used.
- If this setting is not configured either here or in the .ini file, this policy is disabled.

Offline profile support

Lets you enable the offline profile feature. This feature allows profiles to synchronize with the user store at the earliest opportunity.

This feature aims at laptop or mobile device users who often roam. When a network disconnection occurs, profiles remain intact on the laptop or device even after restart or hibernation. When mobile users start sessions, their profiles are updated locally. Profile Management synchronizes their profiles with the user store only after the network connection restores.

Configuration precedence:

- If this policy isn't configured here, the value from the .ini file is used.
- If this policy is not configured either here or in the .ini file, offline profiles are disabled.

Profile Management\Advanced settings

Number of retries when accessing locked files

Lets you specify the number of retries when accessing locked files.

It is most unlikely that you need to enable this policy.

During logoff, if there are any locked files, Profile Management tries the specified number of times to access the files and copy them back to the user store. But typically Profile Management only reads (not writes to) the files for the copy operation to succeed. If any locked files exist, Profile Management doesn't delete the local profile and instead leaves it "stale"(as long as the appropriate policy was enabled).

We recommend that you do not enable this policy.

Configuration precedence:

1. If this policy is disabled, the default value of five retries is used.
2. If this policy isn't configured here, the value from the .ini file is used.
3. If this policy is not configured either here or in the .ini file, the default value is used.

Process Internet cookie files on logoff

Some deployments leave extra Internet cookies that `Index.dat` does not reference. The extra cookies left in the file system after sustained browsing can lead to profile bloat. This policy lets you en-

able Profile Management to force processing of Index.dat and remove the extra cookies. The policy increases logoff times, so enable it only after you experience this issue.

Configuration precedence:

1. If this policy isn't configured here, the value from the .ini file is used.
2. If this policy is not configured either here or in the .ini file, no processing of Index.dat takes place.

Disable automatic configuration

Profile Management examines any Citrix virtual desktops environment, for example for the presence of personal vDisks, and configures Group Policy accordingly. Only Profile Management policies in the Not Configured state are adjusted, so any customizations you have made are preserved.

This policy lets you speed up deployment and simplifies optimization. You do not need to configure this policy. However, you can disable automatic configuration when doing one of the following:

- Upgrading to retain settings from earlier versions
- Troubleshooting

You can regard automatic configuration as a dynamic configuration checker that automatically configures the default policy settings according to environments at runtime. It eliminates the need to configure the settings manually. Runtime environments include:

- Windows OS
- Windows OS versions
- Presence of Citrix virtual desktops
- Presence of personal vDisks

Automatic configuration might change the following policies if the environment changes:

- Active write back
- Always cache
- Delete locally cached profiles on logoff
- Delay before deleting cached profiles
- Profile streaming

See the following table for the default status of the preceding policies on different OSs:

	Multi-session OS	Single-session OS
Active write back	Enabled	Enabled
Always cache	Disabled	Enabled

	Multi-session OS	Single-session OS
Delete locally cached profiles on logoff	Enabled	<i>Disabled</i> if Citrix virtual desktop is assigned or Citrix virtual desktop is not installed. Otherwise, enabled.
Delay before deleting cached profiles	0 seconds	60 seconds if user changes are not persistent; otherwise, 0 seconds.
Profile streaming	Enabled	Enabled
Profile streaming for folders	Enabled	Enabled

However, with automatic configuration disabled, all policies above default to **Disabled**.

To ensure that Start menu roaming works properly on Windows 10, Windows Server 2016, and Windows Server 2019, follow these steps:

1. Enable automatic configuration or set the **Disable automatic configuration** policy to **Enabled**.
2. Complete the configuration steps, as described in the [Profile Management best practices](#) article.

Configuration precedence:

1. If this setting isn't configured here, the value from the .ini file is used.
2. If this setting is neither configured here nor in the .ini file, automatic configuration is turned on. In this case, Profile Management settings might change if the environment changes.

Log off user if a problem is encountered

Lets you specify whether Profile Management logs off users if a problem is encountered.

If this policy is disabled or not configured, Profile Management gives a temporary profile to users if a problem is encountered. For example, the user store is unavailable.

Configuration precedence:

1. If this setting is enabled, an error message is displayed and users are logged off. This setup can simplify troubleshooting of the problem.
2. If this setting isn't configured here, the value from the .ini file is used.
3. If this setting is neither configured here nor in the .ini file, a temporary profile is provided.

Customer Experience Improvement Program

By default, the Customer Experience Improvement Program is enabled to help improve the quality and performance of Citrix products by sending anonymous statistics and usage data.

If this setting isn't configured here, the value from the .ini file is used.

Enable search index roaming for Outlook

With this policy enabled, Profile Management provides native Outlook search experience to users by automatically roaming Outlook search data with user profiles. This policy requires extra storage to store the search index for Outlook.

Log off and then log on again for this policy to take effect.

Outlook search index database –backup and restore

Lets you specify what Profile Management does during logon when the Enable search index roaming for Outlook policy is enabled.

If this policy is enabled, Profile Management backs up the search index database each time the database is mounted successfully on logon. Profile Management treats the backup as the good copy of the search index database. When an attempt to mount the search index database fails due to database corruption, Profile Management reverts the search index database to the last-known good copy.

Note:

Profile Management deletes the previously saved backup after a new backup is saved successfully. The backup consumes the available VHDX storage.

Enable concurrent session support for Outlook search data roaming

Lets Profile Management provide native Outlook search experience in concurrent sessions of the same user. Use this policy with the Search index roaming for Outlook policy.

With this policy enabled, each concurrent session uses a separate Outlook OST file.

By default, only two VHDX disks can be used to store Outlook OST files (one file per disk). If the user starts more sessions, their Outlook OST files are stored in the local user profile. You can specify the maximum number of VHDX disks for storing Outlook OST files.

Enable multi-session write-back for profile containers

Lets you enable write-back for profile containers in multi-session scenarios.

Note:

Citrix Profile Management profile container is available starting with Citrix Profile Management 2103. The FSLogix Profile Container is available starting with Citrix Profile Management 2003.

If the policy is enabled, changes in all sessions are written back to profile containers. Otherwise, only changes in the first session are saved because only the first session is in read/write mode in profile containers.

To use this policy for the FSLogix Profile Container, ensure that the following prerequisites are met:

- The FSLogix Profile Container feature is installed and enabled.
- The profile type is set to **Try for read-write profile and fallback to read-only** in FSLogix.

Replicate user stores

Lets you replicate the remote user profile store to multiple paths on each logon and logoff. Doing so lets Profile Management provide profile redundancy for user logons.

Enabling the policy increases system I/O and might prolong logoffs.

Note:

- This feature is available for both the user store and the full profile container.
- Replicated profile containers provide profile redundancy for user logons but not for in-session failover.

Enable credential-based access to user stores

Lets you enable credential-based access to user stores.

By default, Citrix Profile Management impersonates the current user to access user stores. Therefore, it requires the current user to have permission to access the user store. In some situations, you want to put user stores in a storage repository (for example, Azure Files) that the current user has no permission to access. In those cases, enable this policy to let Profile Management access the user stores by using the credentials of the storage repository.

To ensure that Profile Management can access user stores using credentials, save the credentials in Workspace Environment Management (WEM) or Windows Credential Manager. We recommend you use Workspace Environment Management to eliminate the need of configuring the same credentials for each machine running Profile Management. If you use the Windows Credential Manager, use the Local System account to securely save the credentials.

Note:

This policy is available both for file-based and VHDX-based user stores. For Profile Management versions earlier than 2212, this policy is available only for VHDX-based user stores.

Configuration precedence:

1. If this setting isn't configured here, the value from the .ini file is used.
2. If this setting is not configured either here or in the .ini file, it is disabled by default.

Specify the storage path for VHDX files

Lets you specify a storage path to store VHDX files used in Profile Management.

Citrix Profile Management provides the following VHDX-based policies: Enable native Outlook search experience, Citrix Profile Management profile container, and Accelerate folder mirroring. By default, VHDX files are stored in the user store.

Configuration precedence:

1. If this setting isn't configured here, the value from the .ini file is used.
2. If this setting is not configured either here or in the .ini file, it is disabled by default.

Default capacity of VHD containers

Lets you specify the default storage capacity (in GB) of VHD containers.

Configuration precedence:

1. If this policy is not configured here, the value from the .ini file is used.
2. If this policy is not configured either here or in the .ini file, the default is 50 (GB).

Automatically reattach VHDX disks in sessions

With this policy enabled, Profile Management ensures a high level of stability of VHDX-based policies. By default, this policy is enabled.

When this policy is enabled, Profile Management monitors VHDX disks that are in use by VHDX-based policies. If any of the disks is detached, Profile Management reattaches the disk automatically.

Enable asynchronous processing for user Group Policy on logon

Windows provides two processing modes for user Group Policy: synchronous and asynchronous. Windows uses a registry value to determine the processing mode for the next user logon. If the registry value doesn't exist, synchronous mode is applied. The registry value is a machine-level setting and doesn't roam with users. Thus, asynchronous mode will not be applied as expected if users:

- Log on to different machines.
- Log on to the same machine where the Delete locally cached profiles on logoff policy is enabled.

With this policy enabled, the registry value roams with users. As a result, processing mode is applied each time users log on.

Free space ratio to trigger VHD disk compaction

Applicable when Enable VHD disk compaction is enabled. Lets you specify the free space ratio to trigger VHD disk compaction. When the free space ratio exceeds the specified value on user logoff, disk compaction is triggered.

Free space ratio = (current VHD file size – required minimum VHD file size*) ÷ current VHD file size

* Obtained using the `GetSupportedSize` method of the `MSFT_Partition` class from the Microsoft Windows operating system.

Configuration precedence:

1. If this setting isn't configured here, the value from the .ini file is used.
2. If this setting is not configured either here or in the .ini file, the default value 20 (%) is used.

Number of logoffs to trigger VHD disk compaction

Applicable when Enable VHD disk compaction is enabled. Lets you specify the number of user logoffs to trigger VHD disk compaction.

When the number of logoffs since the last compaction reaches the specified value, disk compaction is triggered again.

Configuration precedence:

1. If this setting isn't configured here, the value from the .ini file is used.
2. If this setting is not configured either here or in the .ini file, the default value 5 is used.

Disable defragmentation for VHD disk compaction

Applicable when Enable VHD disk compaction is enabled. Lets you specify whether to disable file defragmentation for VHD disk compaction.

When VHD disk compaction is enabled, the VHD disk file is first automatically defragmented using the Windows built-in `defrag` tool, and then compacted. VHD disk defragmentation produces better compaction results while disabling it can save system resources.

Configuration precedence:

1. If this setting isn't configured here, the value from the .ini file is used.
2. If this setting is not configured either here or in the .ini file, defragmentation is enabled by default.

Profile container auto-expansion threshold

Lets you specify the utilization percentage of storage capacity at which profile containers trigger auto-expansion.

Configuration precedence:

- If this policy is not configured here, the value from the .ini file is used.
- If this policy is not configured here or in the .ini file, the default is 90 (%) of storage capacity.

Profile container auto-expansion increment

Lets you specify the amount of storage capacity (in GB) by which profile containers automatically expand when auto-expansion is triggered.

Configuration precedence:

- If this policy is not configured here, the value from the .ini file is used.
- If this policy is not configured either here or in the .ini file, the default is 10 (GB).

Profile container auto-expansion limit

Lets you specify the maximum storage capacity (in GB) to which profile containers can automatically expand when auto-expansion is triggered.

Configuration precedence:

- If this policy is not configured here, the value from the .ini file is used.
- If this policy is not configured either here or in the .ini file, the default is 80 (GB).

Enable OneDrive container

Lets OneDrive folders roam with users.

The OneDrive container is a VHDX-based folder roaming solution. Profile Management creates a VHDX file per user on a file share and stores the users' OneDrive folders into the VHDX files. The VHDX files are attached when users log on and detached when users log off.

UWP app roaming

Lets you enable UWP (Universal Windows Platform) apps to roam with users. As a result, users can access the same UWP apps from different devices.

With this policy enabled, Profile Management lets UWP apps roam with users by storing the apps on separate VHDX disks. Those disks are attached during user logons and detached during user logoffs.

Configuration precedence:

If this setting is not configured here, the value from the .ini file is used.

If this setting is configured neither here nor in the .ini file, this feature is disabled.

Enable user-level policy settings

With this policy enabled, machine-level policy settings can work at the user level, and user-level settings override machine-level settings.

Configuration precedence:

1. If this policy is not configured here, the value from the .ini file is used.
2. If this policy is not configured either here or in the .ini file, it is disabled.

Set priority order for user groups

Specify the priority order for user groups. The order determines which group takes precedence when a user belongs to multiple groups with different policy settings.

When a user belongs to multiple groups with conflicting policy settings, consider the following:

- If the user belongs to one or more groups defined in this policy, the group with the highest priority takes precedence.
- If the user doesn't belong to any of the groups defined in this policy, the group with the SID listed earliest in alphabetical order takes precedence.

Configuration precedence:

1. If this setting is not configured here, the value from the .ini file is used.
2. If this setting is not configured either here or in the .ini file, no priority order is specified.

User store selection method

Lets you specify the user store selection method when multiple user stores are available. Options include:

- **Configuration order.** Profile Management selects the earliest configured store.
- **Access performance.** Profile Management selects the store with the best access performance.

Configuration precedence:

1. If this setting isn't configured here, the value from the .ini file is used.
2. If this setting isn't configured here or in the .ini file, **Configuration order** is used.

Profile Management\Citrix Virtual Apps Optimization settings

Enable Citrix Virtual Apps Optimization

When you enable this feature, only the settings specific to the published applications a user launches or exits are synchronized.

Configuration precedence:

1. If this setting isn't configured here, the value from the .ini file is used.
2. If this setting is not configured either here or in the .ini file, no optimization settings for Citrix virtual apps are applied.

Path to Citrix Virtual Apps optimization definitions

Lets you specify a folder to store definition files of the Citrix virtual apps optimization.

Configuration precedence:

1. If this setting isn't configured here, the value from the .ini file is used.
2. If this setting is not configured either here or in the .ini file, no Citrix virtual apps optimization settings are applied.

Note:

The folder can reside in the local storage or on an SMB file share.

Profile Management\Cross-platform settings

Enable cross-platform settings

Lets you enable the cross-platform settings. The cross-platform settings feature is primarily used for migration from Windows 7 and Windows Server 2008 to Windows 8 and Windows Server 2012. This migration might also move from Microsoft Office 2003 or Office 2007 to Office 2010.

By default, to ease deployment, cross-platform settings are disabled. Enable this policy only after thorough planning and testing of this feature.

Configuration precedence:

1. If this policy isn't configured here, the value from the .ini file is used.
2. If this policy is not configured either here or in the .ini file, no cross-platform settings are applied.

Cross-platform settings user groups

Lets you specify Windows user groups to which the cross-platform settings feature applies. For example, you can use this policy to process only the profiles from a test user group.

Configuration precedence:

1. If this policy is configured, the cross-platform settings feature of Profile Management processes only members of these user groups. If this policy is disabled, the feature processes all users specified by the Processed groups policy.
2. If this policy isn't configured here, the value from the .ini file is used.
3. If this policy is not configured either here or in the .ini file, all user groups are processed.

Path to cross-platform definitions

Lets you specify the network location where the definition files reside.

This path must be a UNC path. Users must have read access to this location, and administrators must have write access to it. The location must be a Server Message Block (SMB) or Common Internet File System (CIFS) file share.

Configuration precedence:

1. If this policy isn't configured here, the value from the .ini file is used.
2. If this policy is not configured either here or in the .ini file, no cross-platform settings are applied.

Path to cross-platform settings store

Lets you specify the path to the cross-platform settings store. The store refers to the folder in which users' cross-platform settings are saved.

This store resides in the user store where profile data shared by multiple platforms is located. Users must have write access to the store. The path can be an absolute UNC path or a path relative to the home directory. You can use the variables used in **Path to user store**.

Configuration precedence:

1. If this policy is disabled, the `Windows\PM_CP` path is used.
2. If this policy isn't configured here, the value from the .ini file is used.
3. If this policy is not configured either here or in the .ini file, the default value is used.

Source for creating cross-platform settings

Lets you specify a platform as the base platform if this policy is enabled in that platform's OU. This policy migrates data from the base platform's profiles to the cross-platform settings store. By default, this policy is disabled.

Each platform's own set of profiles are stored in a separate OU. Decide which platform's profile data that you want to use as the base platform to seed the cross-platform settings store.

With this policy enabled, when one of the following situations occurs, Profile Management migrates the data from the single-platform profile to the store.

- The cross-platform settings store contains a definition file with no data.
- The cached data in a single-platform profile is newer than the definition's data in the store.

Important:

If this policy is enabled in multiple OUs, user objects, or machine objects, the platform that the first user logs on to become the base profile.

Profile Management\File system

Exclusion list - files

Lets you specify the files that Profile Management ignores during synchronization. File names must be paths relative to the user profile (%USERPROFILE%). Wildcards are allowed and are applied recursively.

Examples:

- `Desktop\Desktop.ini` ignores the `Desktop.ini` file in the `Desktop` folder.
- `%USERPROFILE%*.tmp` ignores all files with the `.tmp` extension in the entire profile.
- `AppData\Roaming\MyApp*.tmp` ignores all files with the `.tmp` extension in one part of the profile.

Configuration precedence:

1. If this policy is disabled, no files are excluded.
2. If this policy isn't configured here, the value from the `.ini` file is used.
3. If this policy is not configured either here or in the `.ini` file, no files are excluded.

Enable Default Exclusion List - directories

Lets you specify the default list of directories that Profile Management ignores during synchronization. Use this policy to specify GPO exclusion directories without having to fill them in manually.

Configuration precedent:

1. If you disable this policy, Profile Management does not exclude any directories by default.
2. If you do not configure this policy here, Profile Management uses the value from the `.ini` file.
3. If you do not configure this policy here or in the `.ini` file, Profile Management does not exclude any directories by default.

Exclusion list - directories

Lets you specify the folders that Profile Management ignores during synchronization. Folder names must be specified as paths relative to the user profile (`%USERPROFILE%`).

Example:

- `Desktop` ignores the `Desktop` folder in the user profile

Configuration precedence:

1. If this policy is disabled, no folders are excluded.
2. If this policy isn't configured here, the value from the `.ini` file is used.
3. If this policy is not configured either here or in the `.ini` file, no folders are excluded.

Logon Exclusion Check

Lets you specify what Profile Management does if a profile in the user store contains excluded files or folders.

Configuration precedence:

1. If this setting is disabled or set to the default value of **Synchronize excluded files or folders**, Profile Management synchronizes those excluded files or folders from the user store to the local profile when a user logs on.
2. If this setting is set to **Ignore excluded files or folders**, Profile Management ignores the excluded files or folders in the user store on user logon. If this setting is set to **Delete excluded files or folders**, Profile Management deletes the excluded files or folders in the user store on user logon.
3. If this setting isn't configured here, the value from the .ini file is used.
4. If this setting is neither configured here nor in the .ini file, Profile Management synchronizes excluded files or folders from the user store to the local profile.

Large File Handling - Files to be created as symbolic links

Lets you specify the files that are created as symbolic links. This setting is used to improve logon performance and to process large-size files.

You can use wildcards in policies that refer to files. Example, `!ctx_localappdata!\Microsoft\Outlook*.OST`.

To process the Offline Outlook Data File (*.ost), make sure that the **Outlook** folder is not excluded for Profile Management.

Those files cannot be accessed in multiple sessions simultaneously.

Profile Management\File system\Synchronization

Directories to synchronize Lets you specify folders that you want Profile Management to synchronize when their parent folders are excluded.

Paths on this list must be relative to the user profile.

Profile Management synchronizes each user's entire profile between the system where it is installed and the user store. It is not necessary to include subfolders of the user profile by adding them to this list.

Disabling this policy has the same effect as enabling it and configuring an empty list.

Configuration precedence:

1. If this policy isn't configured here, the value from the .ini file is used.
2. If this policy is not configured either here or in the .ini file, only non-excluded folders in the user profile are synchronized.

Files to synchronize Lets you specify files that you want Profile Management to synchronize when their parent folders are excluded.

Paths on this list must be relative to the user profile. Wildcards can be used in file names and folder names. But wildcards are applied recursively only in file names.

Examples:

- AppData\Local\Microsoft\Office\Access.qat specifies a file in a folder that is excluded in the default configuration
- AppData\Local\MyApp*.cfg specifies all files with the extension .cfg in the profile folder AppData\Local\MyApp and its subfolders

Profile Management synchronizes each user's entire profile between the system where it is installed and the user store. It is not necessary to include files in the user profile by adding them to this list.

Disabling this policy has the same effect as enabling it and configuring an empty list.

Configuration precedence:

1. If this policy isn't configured here, the value from the .ini file is used.
2. If this policy is not configured either here or in the .ini file, only non-excluded files in the user profile are synchronized.

Folders to mirror This policy can help solve issues involving any transactional folder (also known as a referential folder). That type of folder contains interdependent files, where one file references other files.

With the policy, Profile Management processes a transactional folder and its contents as a single entity when synchronizing user profiles.

Configuration precedence:

1. If this policy isn't configured here, the value from the .ini file is used.
2. If this policy is not configured either here or in the .ini file, no folders are mirrored.

Accelerate folder mirroring With both this policy and the **Folders to mirror** policy enabled, Profile Management stores mirrored folders on a VHDX-based virtual disk. It attaches the virtual disk during logons and detaches it during logoffs. Enabling this policy eliminates the need to copy the folders between the user store and local profiles and accelerates folder mirroring.

Profile Management\File deduplication

Identical files can exist among various user profiles in the user store. Having duplicate instances of files stored in the user store increases your storage cost.

File deduplication policies let Profile Management remove duplicate files from the user store and store one instance of them in a central location (called *shared store*). Doing so avoids file duplications in the user store, thus saving your storage cost.

Files to include in the shared store for deduplication

Lets you enable file deduplication and specify files to include in the shared store for deduplication.

Files to exclude from the shared store

Lets you specify files to exclude from the shared store. Use this policy along with the *Files to include in the shared store for deduplication* policy.

Minimum size of files to deduplicate from profile containers

Lets you specify the minimum size of files to deduplicate from profile containers. This size must be 256 MB or greater.

Configuration precedence:

1. If this setting is not configured here, the value from the .ini file is used.
2. If this setting is not configured either here or in the .ini file, the value is 256.

Profile Management\Log settings

Enable logging

Lets you specify whether to enable logging for Profile Management. Enable this policy only when you are troubleshooting Profile Management.

Configuration precedence:

1. If this policy is disabled, only errors are logged. If this policy isn't configured here, the value from the .ini file is used.
2. If this policy is not configured either here or in the .ini file, only errors are logged.

Log settings

Lets you select which events or actions Profile Management logs. Select them all only if you are requested to do so by Citrix personnel.

Configuration precedence:

1. If the policy isn't configured here, Profile Management uses the values from the .ini file.
2. If this policy is not configured either here or in the .ini file, errors and general information are logged.

The checkboxes for this policy correspond to the following settings in the .ini file: LogLevelWarnings, LogLevelInformation, LogLevelFileSystemNotification, LogLevelFileSystemActions, LogLevelRegistryActions, LogLevelRegistryDifference, LogLevelActiveDirectoryActions, LogLevelPolicyUserLogon, LogLevelLogon, LogLevelLogoff, and LogLevelUserName.

Maximum size of the log file

Lets you specify the maximum size of the Profile Management log file in bytes.

The default value for the maximum size of the Profile Management log file is 10 MB. If you have sufficient disk space, increase the value. If the log file grows beyond the maximum size, the following happens:

1. An existing backup of the file (.bak) is deleted.
2. The log file is renamed to .bak.
3. A new log file is created.

The log file is created in %SystemRoot%\System32\Logfiles\UserProfileManager or in the location that the **Path to log file** policy specifies.

Configuration precedence:

1. If this policy is disabled, the default value of 10 MB is used.
2. If this policy isn't configured here, the value from the .ini file is used.
3. If this policy isn't configured either here or in the .ini file, the default value is used.

Path to log file

Lets you configure an alternative path to store the log files.

The path can point to a local drive or a network-based one (a UNC path):

- Remote drives are recommended in large, distributed environments. However, they can create significant network traffic, which might not be appropriate for log files.
- Local drives are often used in provisioned virtual machines with a persistent hard drive.

This setting ensures that log files are preserved when the machine restarts. For virtual machines without a persistent hard drive, setting a UNC path allows you to retain the log files. But the system account for the machines must have write access to the UNC share. Use a local path for any laptops managed by the offline profiles feature.

If a UNC path is used for log files, Citrix recommends that you apply an appropriate access control list to the log file folder. Access control ensures that only authorized user or computer accounts can access the stored files.

Examples:

- D:\LogFiles\ProfileManagement.
- \server\LogFiles\ProfileManagement

If this policy isn't configured here, the value from the .ini file is used. If this policy is not configured either here or in the .ini file, the default location %SystemRoot%\System32\Logfiles\UserProfileManager is used.

Profile Management\Profile container settings

Profile container

Lets you use a VHDX-based network disk (profile container) to store user profiles. You can use it to store a user profile in whole or in part. On user logon, the profile container is mounted to the user environment and the profile folders are available immediately.

Enable local caching for profile containers

Lets you enable local caching for Citrix Profile Management profile containers. This policy takes effect only when the profile container is enabled for the entire user profile.

With the policy set to **Enabled**, each local profile serves as a local cache of its Citrix Profile Management profile container. If profile streaming is in use, locally cached files are created on demand. Otherwise, they are created during user logons.

Folders to exclude from profile container

Lets you specify folders to exclude from the Citrix Profile Management profile container.

Folders to include in profile container

Lets you specify folders to keep in the Citrix Profile Management profile container when their parent folders are excluded.

Folders on this list must be subfolders of the excluded folders. Otherwise, this setting does not work.

Disabling this setting has the same effect as enabling it and configuring an empty list.

Files to include in profile container

Lets you specify files to include in the Citrix Profile Management profile container when their parent folders are excluded.

Files on this list must be inside the excluded folders. Otherwise, this setting does not work.

Files to exclude from profile container

Lets you specify files to exclude from the Citrix Profile Management profile container.

Enable VHD disk compaction

Lets you enable VHD disk compaction for Profile Management. If enabled, VHD disks are automatically compacted on user logoff when certain conditions are met. This policy enables you to save the storage space consumed by profile container, OneDrive container, and mirror folder container.

Depending on your needs and the resources available, you can adjust the default VHD compaction settings and behavior using the **Free space ratio to trigger VHD disk compaction**, **Number of logoffs to trigger VHD disk compaction**, and **Disable defragmentation for VHD disk compaction** policies in Advanced settings.

Configuration precedence:

1. If this setting isn't configured here, the value from the .ini file is used.
2. If this setting is not configured either here or in the .ini file, the feature is disabled.

Enable VHD auto-expansion for profile container

Lets you specify whether to enable VHD auto-expansion for the profile container. When enabled, all VHD auto-expansion settings apply to the profile container.

Configuration precedence:

- If this policy is not configured here, the value from the .ini file is used.
- If this policy is not configured either here or in the .ini file, it is disabled.

Enable exclusive access to VHD containers

By default, VHD containers allow concurrent access. With this setting enabled, they allow only one access at a time. This feature applies to profile containers and OneDrive containers.

Note:

In the container-based profile solution, enabling this setting for profile containers automatically disables the *Enable multi-session write-back for profile containers* setting.

Configuration precedence:

1. If this policy is not configured here, the value from the .ini file is used.
2. If this policy is not configured either here or in the .ini file, the setting is disabled.

Log off users when profile container is not available during logon

Lets you specify whether to force log-off users when the profile container is unavailable during user logon and customize the error message users see.

Configuration precedence:

1. If this policy is not configured here, the value from the .ini file is used.
2. If this policy is not configured either here or in the .ini file, the setting is disabled.

Users and groups to access profile container

Lets you specify which AD domain users and groups have Read & Execute permission on profile containers. By default, a profile container is accessible only to its owner.

Configuration precedence:

1. If this policy is not configured here, the setting from the .ini file is used.
2. If this policy is not configured either here or in the .ini file, the profile container is accessible only to its owner.

Profile Management\Profile handling

Delete locally cached profiles on logoff

Lets you specify whether locally cached profiles are deleted after logoff.

If this policy is enabled, a user's local profile cache is deleted after user logoff. This setting is recommended for terminal servers. If this policy is disabled, cached profiles are not deleted.

Note:

You can control when profile caches are deleted on logoff using the Delay before deleting the cached profiles policy.

Configuration precedence:

1. If this policy isn't configured here, the value from the .ini file is used.
2. If this policy is not configured either here or in the .ini file, cached profiles are not deleted.

Delay before deleting cached profiles

Lets you specify an optional extension to the delay before locally cached profiles are deleted on logoff. Extending the delay is useful if you know that a process keeps files or the user registry hives open during logoff. With large profiles, this setup can also speed up logoff.

A value of 0 deletes the profiles immediately, at the end of the logoff process.

Profile Management checks for logoffs every minute. A value of 60 ensures that profiles are deleted between one and two minutes after user logoffs depending on when the last check takes place.

Important: This policy works only if Delete locally cached profiles on logoff is enabled.

If this policy isn't configured here, the value from the .ini file is used. If this policy is not configured either here or in the .ini file, profiles are deleted immediately.

Migration of existing profiles

Lets you specify Profile Management migrate which types of user profiles to the user store if the user store is empty.

Profile Management can migrate existing profiles “on the fly” during logon if the user has no profile in the user store. Select **Roaming** if you are migrating roaming profiles or Remote Desktop Services profiles.

The following event takes place during logons. If the user has a Windows profile instead of a Citrix user profile in the user store, Profile Management migrates the Windows profile to the user store. After this process, Profile Management uses the user store profile in the current and other sessions that are configured with the path to the same user store.

Configuration precedence:

1. If this setting is enabled, profile migration can be activated for roaming and local profiles (the default), roaming profiles only, local profiles only. Or profile migration can be disabled.
2. If this policy is disabled and no Citrix user profile exists in the user store, the existing Windows mechanism for creating profiles is used.

3. If profile migration is disabled and no Citrix user profile exists in the user store, the existing Windows mechanism for creating profiles is used.
4. If this policy isn't configured here, the value from the .ini file is used.
5. If this policy is not configured either here or in the .ini file, Profile Management migrates existing local and roaming profiles to the user store.

Automatic migration of existing application profiles

This setting enables or disables the automatic migration of existing application profiles across different operating systems. The application profiles include both the application data in the **AppData** folder and the registry entries under `HKEY_CURRENT_USER\SOFTWARE`. This setting can be useful in cases where you want to migrate your application profiles across different operating systems.

For example, you need to upgrade your operating system (OS) from Windows 10 version 1803 to Windows 10 version 1809. If this setting is enabled, Profile Management automatically migrates the existing application settings to Windows 10 version 1809 the first time each user logs on. The application data in the **AppData** folder and the registry entries under `HKEY_CURRENT_USER\SOFTWARE` are migrated.

If there are several existing application profiles, Profile Management performs the migration in the following order of priority:

1. Profiles of the same OS type (single-session OS to single-session OS and multi-session OS to multi-session OS).
2. Profiles of the same Windows OS family; for example, Windows 10 to Windows 10, or Windows Server 2016 to Windows Server 2016).
3. Profiles of an earlier version of the OS; for example, Windows 7 to Windows 10, or Windows Server 2012 to Windows 2016.
4. Profiles of the closest OS.

Note:

You must specify the short name of the OS by including the `!CTX_OSNAME!` variable in the user store path. Doing so lets Profile Management locate the existing application profiles.

If this setting isn't configured here, the setting from the .ini file is used.

If this setting is neither configured here nor in the .ini file, it is disabled by default.

Local profile conflict handling

Lets you specify how Profile Management behaves if both a profile in the user store and a local Windows user profile (not a Citrix user profile) exist.

Configuration precedence:

1. If this policy is disabled or set to the default value of **Use local profile**, Profile Management uses the local profile, but does not change it in any way.
2. If this policy is set to **Delete local profile**, Profile Management deletes the local Windows user profile. And then imports the Citrix user profile from the user store. If this policy is set to **Rename local profile**, Profile Management renames the local Windows user profile (for backup purposes). And then imports the Citrix user profile from the user store.
3. If this policy isn't configured here, the value from the .ini file is used. If this policy is not configured either here or in the .ini file, existing local profiles are used.

Template profile

Lets you specify the storage path of the profile you want to use as a template. This path is the full path of the folder containing the NTUSER.DAT registry file and any other folders and files required for the template profile.

Important: Ensure that you do not include `NTUSER.DAT` in the path setting. For example, with the `\\myservername\myprofiles\template\ntuser.dat` file, set the location as `\\myservername\myprofiles\template`.

Use absolute paths, which can be UNC ones or paths on the local computer. You can use the latter, for example, to specify a template profile permanently on a Citrix Provisioning Services image. Relative paths are not supported.

This policy does not support expansion of Active Directory attributes, system environment variables, or the `%USERNAME%` and `%USERDOMAIN%` variables.

Configuration precedence:

1. If this policy is disabled, templates aren't used.
2. If this policy is enabled, Profile Management uses the template instead of the local default profile when creating user profiles. If a user has no Citrix user profile, but a local or roaming Windows user profile exists, by default the local profile is used. And the local profile is migrated to the user store, if this policy is not disabled. This setup can be changed by enabling the **Template profile overrides local profile** or **Template profile overrides roaming profile** check box. Also, identifying the template as a Citrix mandatory profile means that, like Windows mandatory profiles, changes are not saved.
3. If this policy isn't configured here, the value from the .ini file is used.
4. If this policy is not configured either here or in the .ini file, no template is used.

Profile Management\Registry

Exclusion list

Lets you specify the registry keys in the HKCU hive that Profile Management ignores during logoff.

Example: Software\Policies

Configuration precedence:

- If this policy is disabled, no registry keys are excluded.
- If this policy isn't configured here, the value from the .ini file is used.
- If this policy is not configured either here or in the .ini file, no registry keys are excluded.

Inclusion list

Lets you specify registry keys in the HKCU hive that Profile Management processes during logoff.

Example: Software\Adobe.

Configuration precedence:

1. If this policy is enabled, only keys on this list are processed. If this policy is disabled, the complete HKCU hive is processed.
2. If this policy isn't configured here, the value from the .ini file is used.
3. If this policy is not configured either here or in the .ini file, all of HKCU is processed.

Enable Default Exclusion List - Profile Management 5.5

Lets you specify registry keys in the HKCU hive that Profile Management does not synchronize to the user profiles. Use this policy to specify GPO exclusion files without having to fill them in manually.

Configuration precedence:

1. If you disable this policy, Profile Management does not exclude any registry keys by default.
2. If you do not configure this policy here, Profile Management uses the value from the .ini file.
3. If you configure this policy neither here nor in the .ini file, Profile Management does not exclude any registry keys by default.

NTUSER.DAT backup

Lets you enable a backup of the last-known good copy of NTUSER.DAT and roll back when any corruption occurs.

If you do not configure this policy here, Profile Management uses the value from the .ini file. If you configure this policy neither here nor in the .ini file, Profile Management does not back up NTUSER.DAT.

Profile Management\App access control

Lets you control access to files, folders, and registries.

App access control

If enabled, Profile Management controls user access to items (such as files, folders, and registries) based on the rules you provide.

Use the following ways to create application rules:

- GUI-based tool –**WEM Tool Hub > Rule Generator for App Access Control**
- PowerShell tool –available with the Profile Management installation package

Configuration precedence:

1. If this policy isn't configured here, the value from the .ini file is used.
2. If this policy is not configured either here or in the .ini file, it is disabled.

Profile Management\Streamed user profiles

Profile streaming

Lets you enable the profile streaming feature. With this feature enabled, files in user profiles are fetched from the user store to the local computer only when users access them. The **NTUSER.DAT** file and any files in the pending area are the exception. They are fetched immediately. NTUSER.DAT stores registry entries.

Configuration precedence:

1. If this policy isn't configured here, the value from the .ini file is used.
2. If this policy is not configured either here or in the .ini file, it is disabled.

Enable profile streaming for folders

Lets you enable the profile streaming feature for folders in user profiles.

With both this policy and the **Profile streaming** policy set to **Enabled**, folders in a user profile are fetched from the user store to the local computer only when users access them.

Configuration precedence:

1. If this policy isn't configured here, the value from the .ini file is used.
2. If this policy is not configured either here or in the .ini file, it's disabled.

Always cache

Lets you specify the lower limit on the size of files that are fetched from the user store to the local computer immediately after logon.

When the profile streaming feature is enabled, files in user profiles are fetched to the local computers when users access them. This on-demand file-fetching mechanism causes slow loading when files that users request are large. With this policy enabled, Profile Management fetches files larger than a specified size to the local computers immediately after logon.

To fetch the entire profile to the local computer immediately after logon, set this limit to zero.

Configuration precedence:

1. If this policy isn't configured here, the value from the .ini file is used.
2. If this policy is not configured either here or in the .ini file, it's disabled.

Timeout for pending area lock files

Lets you specify a timeout period (days) after which Profile Management frees up users' files. When the timeout occurs, users' files are written to the user store from the pending area if the user store remains locked when its storage server becomes unresponsive. Use this policy to prevent bloat in the pending area and to ensure that the user store always contains the most up-to-date files.

Configuration precedence:

1. If this policy isn't configured here, the value from the .ini file is used.
2. If this policy is not configured either here or in the .ini file, the default value of one day is used.

Streamed user profile groups

Lets you specify Windows user groups whose user profiles are streamed.

This policy streams the profiles of a subset of Windows user groups in the OU. The profiles of users in all other groups are not streamed.

Configuration precedence:

1. If this policy is disabled, all user groups are processed.
2. If this policy isn't configured here, the value from the .ini file is used. If this policy is not configured either here or in the .ini file, all users are processed.

Profile Streaming Exclusion list - directories

Lets you specify the folders that Profile Streaming ignores. Folder names must be specified as paths relative to the user profile.

Examples:

Entering `Desktop` ignores the `Desktop` directory in the user profile.

Configuration precedence:

1. If this setting is disabled, no folders are excluded.
2. If this setting isn't configured here, the value from the .ini file is used.
3. If this setting is not configured either here or in the .ini file, no folders are excluded.

Note:

Profile Streaming exclusions do not indicate that the configured folders are excluded from profile handling. Citrix Profile Management still processes them.

Enable profile streaming for pending area

Lets you enable the profile streaming feature for files and folders in the pending area.

The pending area is used to ensure profile consistency while profile streaming is enabled. It temporarily stores profile files and folders changed in concurrent sessions.

By default, this policy is disabled, and all files and folders in the pending area are fetched to the local profile on logon. With this policy enabled, files in the pending area are fetched to the local profile only when they are requested. Use the policy with the Profile streaming policy to ensure optimal logon experience in concurrent session scenarios.

The policy applies to folders in the pending area when the Enable profile streaming for folders policy is enabled.

Profile Management\Folder Redirection (User Configuration)

Lets you specify whether to redirect folders that commonly appear in profiles and specify the redirection target. Specify targets as UNC paths (for server shares or DFS namespaces) or as paths relative to users' home directory. The home directory is typically configured with the `#homeDirectory#` attribute in the Active Directory.

If a policy isn't configured here, Profile Management does not redirect the specified folder.

Note:

When you use UNC paths for folder redirection, the #homedirectory# variable is not supported. After you choose the **Redirect to the user's home directory** policy, you do not need to specify the path.

The Redirect <folder-name> folder policy lets you specify how to redirect the <folder-name> folder. To do so, select **Enabled** and then type the redirected path.

Caution:

Potential data loss might occur.

You might want to modify the path after the policy takes effect. However, consider potential data loss before you do so. The data contained in the redirected folder might be deleted if the modified path points to the same location as the previous path.

For example, you specify the Contacts path as `path1`. Later, you change `path1` to `path2`. If `path1` and `path2` point to the same location, all data contained in the redirected folder is deleted after the policy takes effect.

To avoid potential data loss, complete the following steps:

1. Apply Microsoft policy to machines where Profile Management is running through Active Directory Group Policy Objects. Detailed steps are as follows:
 - a) Open the Group Policy Management Console.
 - b) Navigate to **Computer Configuration > Administrative Templates > Windows Components > File Explorer**.
 - c) Enable **Verify old and new Folder Redirection targets point to the same share before redirecting**.
2. If applicable, apply hotfixes to machines where Profile Management is running. For details, see <https://support.microsoft.com/en-us/help/977229> and <https://support.microsoft.com/en-us/help/2799904>.

Policies for file-based and container-based solutions

August 6, 2024

Profile Management provides file-based and container-based profile solutions. The following table lists the Profile Management policies and their availability to each solution.

Category	Policy name	Applies to file-based	Applies to container-based	Comments
NA	Reset profile	Y	Y	This setting is a WMI command provided by Profile Management WMI plug-in instead of a policy setting. With the container-based solution enabled, Profile Management creates user profiles and doesn't restore legacy contents in the profile folders such as Downloads and Pictures .
Profile Management	Enable Profile management	Y	Y	
	Processed groups	Y	Y	
	Excluded groups	Y	Y	
	Process logons of local administrators	Y	Y	
	Path to user store	Y	Y	
	Migrate user store	Y	N	
	Active write back	Y	N	
	Active write back registry	Y	N	
	Active write back on session lock and disconnection	Y	N	

Category	Policy name	Applies to file-based	Applies to container-based	Comments
	Offline profile support	Y	N	
Profile Management\Advanced settings	Number of retries when accessing locked files	Y	N	
	Process Internet cookie files on logoff	Y	N	
	Disable automatic configuration	Y	N	
	Log off user if a problem is encountered	Y	Y	
	Customer Experience Improvement Program	Y	Y	
	Enable user-level policy settings	Y	Y	
	Set priority order for user groups	Y	Y	
	Enable search index roaming for Outlook	Y	Y	
	Enable concurrent session support for Outlook search data roaming	Y	Y	
	Enable multi-session write-back for profile containers	Y	Y	
	Replicate user stores	Y	Y	

Category	Policy name	Applies to file-based	Applies to container-based	Comments
	Enable credential-based access to user stores	Y	Y	
	Customize storage path for VHDX files	Y	Y	
	App access control	Y	Y	
	Automatically reattach VHDX disks in sessions	Y	Y	
	Enable asynchronous processing for user Group Policy on logon	Y	Y	
	Enable OneDrive container	Y	Y	
	Free space ratio to trigger VHD disk compaction	Y	Y	
	Number of logoffs to trigger VHD disk compaction	Y	Y	
	Disable defragmentation for VHD disk compaction	Y	Y	
	Profile container auto-expansion threshold	Y	Y	
	Profile container auto-expansion increment	Y	Y	

Category	Policy name	Applies to file-based	Applies to container-based	Comments
	Profile container auto-expansion limit	Y	Y	
	UWP app roaming	Y	Y	
	Default capacity of VHD containers	Y	Y	
	User store selection method	Y	Y	
Profile Management\App Access Control	App access control	Y	Y	
Profile Management\Citrix Virtual Apps Optimization	Enable Citrix Virtual Apps optimization	Y	N	
	Path to Citrix Virtual Apps optimization definitions	Y	N	
Profile Management\Cross-Platform settings	Enable cross-platform settings	Y	N	
	Cross-platform settings user groups	Y	N	
	Path to cross-platform definitions	Y	N	
	Path to cross-platform settings store	Y	N	
	Source for creating cross-platform settings	Y	N	

Category	Policy name	Applies to file-based	Applies to container-based	Comments
Profile Management\ File deduplication	Files to include in the shared store for deduplication	Y	Y	
	Files to exclude from the shared store	Y	Y	
	Minimum size of files to deduplicate from profile containers	Y	Y	
Profile Management\ File system	Exclusion list - files	Y	N	
	Enable default exclusion list - directories	Y	N	
	Exclusion list - directories	Y	N	
	Logon exclusion check	Y	N	
	Large file handling - Files to be created as symbolic links	Y	N	
Profile Management\ File system\ Synchronization	Directories to synchronize	Y	N	
	Files to synchronize	Y	N	
	Folders to mirror	Y	N	
	Accelerate folder mirroring	Y	N	
Profile Management\ Log settings	Enable logging	Y	Y	

Category	Policy name	Applies to file-based	Applies to container-based	Comments
Profile Management\Profile container settings	Log settings	Y	Y	
	Maximum size of the log file	Y	Y	
	Path to log file	Y	Y	
	Profile container	N	Y	
	Folders to exclude from profile container	N	Y	
	Folders to include in profile container	N	Y	
	Files to exclude from profile container	N	Y	
	Files to include in profile container	N	Y	
	Enable local caching for profile containers	N	Y	With this policy enabled in the container-based solution, all policy settings that apply to the file-based solution also work for the container-based solution, such as Profile streaming and Active write back.
	Enable VHD disk compaction	Y	Y	

Category	Policy name	Applies to file-based	Applies to container-based	Comments
	Enable VHD auto-expansion for profile container	Y	Y	
	Enable exclusive access to VHD containers	Y	Y	
	Log off users when profile container is not available during logon	N	Y	
	Users and groups to access profile container	Y	Y	
Profile Management\Profile handling	Delete locally cached profiles on logoff	Y	N	With the container-based solution enabled, the local profile is always automatically deleted on user logoff even if the policy is disabled.
	Delay before deleting cached profiles	Y	Y	With the container-based solution enabled, the local profile is always automatically deleted on user logoff even if the policy is disabled.

Category	Policy name	Applies to file-based	Applies to container-based	Comments
	Migration of existing profiles	Y	N	With the container-based solution enabled, the local profile will be automatically migrated to the container on user logoff.
	Automatic migration of existing application profiles	Y	N	
	Local profile conflict handling	Y	N	With the container-based solution enabled, the local profile will be automatically migrated to the container on user logoff.
	Template profile	Y	Y	
Profile Management\Registry	Exclusion list	Y	N	
	Enable Default Exclusion list	Y	N	
	Inclusion list	Y	N	
	NTUSER.DAT backup	Y	N	
Profile Management\Streamed user profiles	Profile streaming	Y	N	

Category	Policy name	Applies to file-based	Applies to container-based	Comments
	Enable profile streaming for folders	Y	N	
	Enable profile streaming for pending area	Y	N	
	Always cache	Y	N	
	Timeout for pending area lock files (days)	Y	N	
	Streamed user profile groups	Y	N	
	Profile Streaming exclusion list - directories	Y	N	

Integrate

August 6, 2024

This section contains information for Citrix administrators deploying Profile Management with other Citrix products or components. Use this information in addition to, not instead of, the other topics in the Profile Management documentation. For example, for solutions to common issues with Profile Management in such deployments, see [Troubleshoot](#).

This section also contains information about how some third-party products interact with Profile Management or profiles in general.

Profile Management and Citrix Virtual Apps

August 6, 2024

Use of this version of Profile Management on Citrix Virtual Apps servers is subject to the Profile Management EULA. You can also install Profile Management on local desktops, allowing users to share

their local profile with published resources.

Note: Profile Management automatically configures itself in Citrix virtual desktops but not Citrix virtual apps environments. Use Group Policy or the .ini file to adjust Profile Management settings for your Citrix Virtual Apps deployment.

Profile Management works in Citrix Virtual Apps environments that employ Remote Desktop Services (formerly known as Terminal Services). In these environments, you must set up an OU for each supported operating system. For more information, see your Microsoft documentation.

In farms that contain different versions of Citrix Virtual Apps or that run different operating systems, Citrix recommends using a separate OU for each server that runs each version or operating system.

Important: Including and excluding folders that are shared by multiple users (for example, folders containing shared application data published with Citrix Virtual Apps) is not supported.

Streamed applications

Profile Management can be used in environments where applications are streamed to either user devices directly or streamed to Citrix Virtual Apps servers and, from there, published to users.

Client-side application virtualization technology in Citrix Virtual Apps is based on application streaming which automatically isolates the application. The application streaming feature enables applications to be delivered to Citrix Virtual Apps servers and client devices, and run in a protected virtual environment. There are many reasons to isolate the applications that are being streamed to users, such as the ability to control how applications interact on the user device to prevent application conflicts. For example, isolation of user settings is required if different versions of the same application are present. Microsoft Office 2003 might be installed locally and Office 2007 might be streamed to users' devices. Failure to isolate user settings creates conflicts, and might severely affect the functionality of both applications (local and streamed).

For requirements relating to the use of Profile Management with streamed applications, see [System requirements](#).

Profile Management and Citrix Virtual Desktops

August 6, 2024

Important: We recommend using the Profile Management capabilities integrated into Citrix Virtual Desktops. For more information, see the [Citrix Virtual Desktops documentation](#). The information in this topic applies to a different deployment

- the use of Citrix Virtual Desktops with the Profile Management component that has been separately installed and configured.

Install and upgrade Profile Management in Citrix Virtual Desktops deployments

Use of this version of Profile Management with Citrix Virtual Desktops is subject to the Profile Management EULA. Subject to the terms in the EULA, you can also use Profile Management with Citrix Virtual Apps in a Citrix Virtual Desktops environment.

If you upgrade Profile Management in a Citrix Virtual Desktops deployment, consider the effect on the log file locations as described in [Upgrade Profile Management](#).

For Citrix Virtual Desktops in Quick Deploy setups, see the recommendations in [Decide on a configuration](#).

Configure Profile Management in Citrix Virtual Desktops deployments

If Profile Management has not been configured correctly on the images before they are rolled out, the Profile Management Service starts before Group Policy is applied. To avoid this, perform the configuration using the documented procedures before you put the images into a production environment.

Important: Including and excluding folders that are shared by multiple users (for example, folders containing data that can be shared by multiple virtual desktops) is not supported.

Configure Profile Management in Personal vDisk deployments

If you use the Personal vDisk feature of Citrix Virtual Desktops, Citrix user profiles are stored on virtual desktops' personal vDisks by default, typically the P: drives. The profiles are not stored on users' C: drives. However, this is where Profile Management expects to find the profiles. So you must modify the Registry on the master image while installing or upgrading the Virtual Delivery Agent. In addition, because you have freed up space on the Personal vDisk, it is also good practice to increase the default allocation of disk space for applications on the master image. For instructions on these modifications, see [Managing Citrix Virtual Desktops documentation](#).

Do not delete the copy of a profile in the user store while a copy remains on the Personal vDisk. Doing so creates a Profile Management error, and causes a temporary profile to be used for logons to the virtual desktop. For more information, see [Users Receive New or Temporary Profiles in Troubleshooting common issues](#).

Windows Apps - Microsoft Store

In Citrix Virtual Desktops environments, applications on the Microsoft Store (also known as UWP apps) are supported. To use Microsoft Store applications on a pooled machine (pooled-random, static, or RDS), open the Group Policy Management Editor and then configure the following settings at **Policies > Administrative Templates > Classic Administrative Templates (ADM) > Citrix > Profile Management > File System > Synchronization**:

- Enable Folders to mirror and then add `appdata\local\packages` to the list of folders to mirror
- Enable Files to synchronize and then add `!ctx_localappdata!\Microsoft\Windows\UsrClass.dat*` to the list of files to synchronize

Microsoft Store applications might not work if users access a dedicated desktop with a Personal vDisk (the recommended solution) when their profile was already created on another desktop.

Example Settings for Citrix Virtual Desktops

This topic lists Profile Management policy settings used in a typical Citrix Virtual Desktops deployment. Windows 7 virtual desktops are created with Citrix Provisioning Services and are shared by multiple users. In this example, the desktops, which are created from a pooled-random catalog and are deleted at logoff, are intended for use on static workstations (not mobile laptops) and personal vDisks are not used.

Where no policy is listed, no selection or entry was made in Group Policy, and the default setting applies.

Note the following:

- **Path to user store** - You can incorporate Profile Management variables into the path to the user store. This example uses `!CTX_OSNAME!` and `!CTX_OSBITNESS!`, which expand to Win7 and x86 respectively when the path is interpreted. The AD attribute `#sAMAccountName#` is also used to specify user names.
- **Delete locally cached profiles on logoff** - Disabling this policy is safe because the desktops do not include personal vDisks and get deleted when users log off. Preserving locally cached profiles is therefore unnecessary. (If the desktops were not discarded at logoff, enable this policy.)
- **Profile streaming** - Enabling this setting improves logon times in this deployment.
- **Active write back** - This policy is enabled because the pooled desktops in this deployment are only temporarily allocated to users. The users might therefore change their profile but might forget (or not bother) to close their desktop session. With this setting enabled, local file changes in the profile are mirrored in the user store before logoff.

Note: If you enable the Active write back policy, performing a significant number of file operations in a session - such as file creation, file copy, and file deletion –can cause high system I/O activity and result in temporary performance issues while Profile Management synchronizes the file changes to the user store.

- **Process logons of local administrators** - Enabling this setting is recommended for Citrix Virtual Desktops deployments, in which most users are local administrators.
- **Processed groups** - All domain users' profiles are managed by Profile Management.
- **Exclusion list - directories** (file system) and **Exclusion list** (registry) - These settings prevent the listed temporary or cached files, and the listed registry entries, from being processed. These files and entries are commonly stored in user profiles.
- **Directories to synchronize** and **Files to synchronize** - Knowledge of where users' application data is stored helped define these settings.

Important: Citrix Virtual Desktops deployments vary, so the Profile Management policy settings you decide on are probably different to those in this example. To plan your settings, follow the advice in [Decide on a configuration](#).

Citrix/Profile Management

- Enable Profile Management
Enabled
- Processed groups
MyDomainName\Domain Users
- Path to user store
\\MyServer.MyDomain\MyUserStore\#sAMAccountName#\!CTX_OSNAME!\!CTX_OSBITNESS!
- Active write back
Enabled
- Process logons of local administrators
Enabled

Citrix/Profile Management/Profile handling

- Delete locally cached profiles on logoff
Disabled

Citrix/Profile Management/Advanced settings

- Process Internet cookie files on logoff
Enabled

Citrix/Profile Management/File system

- Exclusion list - directories
\$Recycle.Bin
AppData\Local\Microsoft\Windows\Temporary Internet Files
AppData\Local\Microsoft\Outlook
AppData\Local\Temp
AppData\LocalLow
AppData\Roaming\Microsoft\Windows\Start Menu
AppData\Roaming\Sun\Java\Deployment\cache
AppData\Roaming\Sun\Java\Deployment\log
AppData\Roaming\Sun\Java\Deployment\tmp

Citrix/Profile Management/File system/Synchronization

- Directories to synchronize
AppData\Microsoft\Windows\Start Menu\Programs\Dazzle Apps
- Folders to mirror
AppData\Roaming\Microsoft\Windows\Cookies

Citrix/Profile Management/Streamed user profiles

- Profile streaming
Enabled

Profile Management and UE-V

August 6, 2024

Profile Management 5.x and Microsoft User Experience Virtualization (UE-V) 2.0 can co-exist in the same environment. UE-V is useful when multiple profile versions are present (for example, Version 1 and Version 2 profiles). For this reason, do not use the cross-platform settings feature of Citrix Profile Management when UE-V is present. UE-V might be preferred over that feature because it supports more applications, synchronization during user sessions, and XML configuration and generation for applications.

When Profile Management co-exists with UE-V, no matter whether the cross-platform settings feature is enabled:

- Exclude the AppData\Local\Microsoft\UEV folder. Profile settings captured by UE-V then overwrite profile settings captured by Profile Management.
- Do not share profiles controlled by UE-V with those controlled by Profile Management alone. If you do, the “last write wins.” In other words, the last component to synchronize the profile (UE-V or Profile Management) determines which data is saved, which can lead to data loss.

Note: UE-V requires the Microsoft Desktop Optimization Pack (MDOP).

Profile Management and Citrix Content Collaboration

August 6, 2024

The information in this article applies to the use of Profile Management in Citrix Content Collaboration deployments. Some of it might also be useful for other internet-based file-sharing systems.

You can use Citrix Content Collaboration with Profile Management 4.1.2 and later. Citrix Content Collaboration is only supported in On-Demand mode.

Installation

If you use ShareFile 2.7, to avoid a compatibility issue install this version first before installing Profile Management. This installation dependency does not exist with ShareFile 2.6.

Exclusions

Citrix Content Collaboration stores configuration data locally in the `\AppData\Roaming\ShareFile` folder. For users with Citrix user profiles, this data must roam with the user profile so that the user-specific Citrix Content Collaboration configuration is persisted. Since this `ShareFile` folder is part of the profile, no Profile Management configuration is required. The configuration data roams by default.

However, user data that is managed by Citrix Content Collaboration is contained in the `ShareFile` folder that is in the root of the profile (`%USERPROFILE%\ShareFile`). This data must not roam with the profile because it is managed by, and synchronizes with, the Citrix Content Collaboration server. You must therefore add this folder as a Profile Management exclusion. For instructions on setting exclusions, see [Include and exclude items](#).

Personal vDisks

If you create virtual desktops with Personal vDisks, configure Citrix Content Collaboration with the location of the user data on the vDisks. This ensures that file synchronization can take place between the desktops and the Citrix Content Collaboration server. By default, Personal vDisks are mapped as P: drives on the desktops so the data might be located in `P:\Users\<user name>`. In this case, you would set the location using the `LocalSyncFolder` policy in Citrix Content Collaboration.

Important: To prevent unnecessary synchronizations, which can adversely affect the performance of Profile Management and Personal vDisks, we recommend using the **Folder-ID** setting on folders that contain large files unless they need to be synchronized on the virtual desktop. This is a `ShareFile` setting.

Profile Management and App-V

August 6, 2024

You can use Profile Management in the same environment as Microsoft Application Virtualization 5.x (App-V 5.x).

Note:

Profile Management supports only globally published App-V.

Exclude the following items using Profile Management exclusions:

- Profile Management\File system\Exclusion list\directories:

- AppData\Local\Microsoft\AppV
- AppData\Roaming\Microsoft\AppV\Client\Catalog
- Profile Management\registry\Exclusion list:
 - Software\Microsoft\AppV\Client\Integration
 - Software\Microsoft\AppV\Client\Publishing

For instructions on setting exclusions, see [Include and exclude items](#).

If the **UserLogonRefresh** setting is enabled in App-V, disable the Profile streaming policy in Profile Management. This restriction is the result of an incompatibility of **UserLogonRefresh** with Profile streaming.

For an example of how to sequence an App-V application, see <https://docs.microsoft.com/en-us/windows/application-management/app-v/appv-sequence-a-new-application>.

For information on configuring third-party Profile Management solutions with App-V enabled, see <https://docs.microsoft.com/en-us/microsoft-desktop-optimization-pack/appv-v5/performance-guidance-for-application-virtualization-50>. Do not include Software\Classes on Microsoft Windows 10 systems.

Profile Management and Provisioning Services

August 6, 2024

This article contains advice on maintaining Citrix user profiles on virtual disks (vDisks) created with Citrix Provisioning Services. Before following this advice, understand how your vDisk configuration affects your Profile Management configuration as described in [Persistent or provisioned and dedicated or shared](#)

Supported modes

You can use Profile Management on vDisks running in standard image and private image modes but not difference disk image mode.

To remove non-essential, locally cached profiles from the Master Target Device

To prevent any non-essential, locally cached profiles being stored, ensure that these profiles are removed from vDisks running in standard image mode before taking the Master Target Device image. But do not remove the currently logged-on local administrator's profile. A good way of achieving this is as follows. During this procedure, error messages might be displayed.

1. Right-click Computer.
2. Select Properties.
3. Click Advanced system settings.
4. On the Advanced tab, click Settings in User Profiles.
5. Highlight each profile you want to remove and click Delete.

Retrieve log files from vDisk images

This topic provides guidance on using log files that reside on shared (vDisk) images created with Citrix Provisioning Services. Profile Management saves the files at logoff. But, if you use vDisk images, take account of the fact that base images can be reset, which results in log files being deleted. You therefore must take some action to retrieve the files. The action you take depends on whether the log files are being deleted at logon or logoff.

Use of vDisk images is common in Citrix virtual desktops deployments, so the guidance in this topic uses that product as an example.

To retrieve a log file that is deleted at logoff

If entire profiles or parts of them are not saved back to the user store on the network, the log file is also not saved there.

If the Provisioning Services write-cache is stored on the computer running Provisioning Services, this issue does not arise. And the log file is saved back to the user store.

If the write-cache is stored locally, in this procedure you might have to log on from the same device as the user. However, even this might fail if the write-cache is stored locally in RAM.

If the write cache is not on the computer running Provisioning Services, you might have to create a copy of the vDisk image. You assign it to the new virtual machine, and change the write-cache on the image so it is stored on that computer.

1. In Citrix virtual desktops, create a desktop group, add one virtual machine to it, and point it to your vDisk image.
2. Grant access to the virtual machine to one test user and the administrator.
3. Modify the desktop group's idle pool count to 1 for all times of the day (to stop power management turning the machine off). Set its logoff behavior to Do nothing (to prevent the machine restarting and resetting the image).
4. Log on as the test user to the virtual desktop and then log off from it.
5. Log on as administrator from the XenCenter or VMware console, and retrieve the log file.

Consult the [Citrix Virtual Desktops documentation](#) for more information on creating desktop groups and modifying their properties.

To retrieve a log file that is deleted at logon

If a profile is current in the user store on the network but does not load correctly when the user logs on, log file entries are lost.

1. Map a drive to \\<vmhostname>\C\$ and, before the user logs off the session, locate the log file. The log file is not complete (some entries might be missing) but if the problem you are troubleshooting is at logon, it can provide enough information for you to isolate the cause of the issue.

To relocate Provisioning Services log files

Using standard image mode, the Provisioning Services event log files are lost when the system shuts down. For instructions on changing the default location of the files to prevent this, see Knowledge Center article [CTX115601](#).

Preconfigure Profile Management on provisioned images

August 6, 2024

Using provisioning software such as Citrix Provisioning Services, Citrix XenServer, or VMware ESX you can build images that have Profile Management pre-installed. When doing so, you likely capture some Group Policy settings in the registry while you set up the image. For example, it happens while it is in Private Image mode with Provisioning Services. The settings are still present when you deploy the image. For example, when you switch back to standard image mode with Provisioning Services. Ideally, choose defaults that suit the state of the virtual machine when it starts running and your users requirements when they log on. At a minimum, ensure that you have suitable defaults for those policies described in [Persistent or provisioned and dedicated or shared](#)

The defaults are used if `gpupdate` is not run before the Citrix Profile Management Service starts. So it is best to ensure that they are sensible defaults for most cases. Use this procedure to preconfigure these and other settings you want to preserve in the image.

Note: If you use Provisioning Services, we recommend that you preconfigure images with the Profile Management .ini file first. And you transfer the settings to the .adm or .admx file only once your testing proves successful.

1. If you use the .adm or .admx file, change the desired settings using the file in the appropriate GPO. If you use the .ini file, omit this step; you make the changes in a later step.
2. Make the same changes to the log level.

3. Do one of the following:
 - Switch the image to Private Image mode (Citrix Provisioning Services) and start the operating system on it.
 - Start the operating system (Citrix XenServer or VMware ESX).
4. Log on using an Administrator account (not any test user account you might have set up), and run `gpupdate /force`. This step ensures that the registry is correctly configured.
5. If you use the .ini file, change the desired settings in the file.
6. Stop the Profile Management Service.
7. To avoid confusion with the new log files that are created, delete the old Profile Management log file and the configuration log file. These have file names that use the name of the old image. They are redundant because the updated image has new files (with the name of the new image).
8. Do one of the following:
 - Switch the image back to standard image mode (Citrix Provisioning Services).
 - Save the updated image (Citrix XenServer or VMware ESX).
9. Start the operating system on the image.

Profile Management and Self-service Plug-in

August 6, 2024

By default, Profile Management excludes the Windows **Start Menu** folder. Citrix Self-service Plug-in users cannot see their subscribed applications in the **Start Menu**. Adjust this default behavior by removing the folder `%APPDATA%\Microsoft\Windows\Start Menu` from the **Exclusion list - directories** policy. In addition, when using GPOs for configuration, it is a best practice to delete the Profile Management .ini file. These actions ensure that the **Start Menu** folder containing subscribed applications (and any user-created subfolders) are processed by Profile Management.

Note: If you are using the Profile Management .ini file rather than Group Policy, remove this entry from the default exclusion list in that file.

Profile Management and VMware

August 6, 2024

This article applies to Citrix user profiles on virtual machines created with VMware software such as VMware ESX. It addresses an issue where local profile caches become locked.

If you have set up Profile Management to delete cached local profiles when users log off from their virtual machines created with VMware (in your deployment of Citrix virtual desktops or virtual apps) but the profiles are not deleted, you can use this workaround to overcome the issue.

This issue occurs when roaming profiles are used on virtual machines created with VMware ESX 3.5, and the Profile Management setting **Delete locally cached profiles on logoff** is enabled.

The issue occurs because the Shared Folders option in VMware Tools adds a file to the profiles. And the file is locked by a running process thus preventing profiles being deleted at logoff. The file is C:\Documents and Settings\userid\Application Data\VMware\hgfs.dat.

If you have verbose logging enabled in Profile Management, the log file might detect this problem with an entry such as:

```
2009-06-03;11:44:31.456;ERROR;PCNAME;JohnSmith4;3;3640;DeleteDirectory : Deleting the directory \<C:\Documents and Settings\<user name\>\Local Settings\Application Data\VMware> failed with: The directory is not empty.
```

To work around this issue in a Citrix virtual apps deployment on Windows Server 2008:

1. Log on as Administrator to the Citrix virtual apps server.
2. In Citrix virtual apps deployments, log off all users from the server.
3. In the Control Panel, go to **Add/Remove Programs**.
4. Locate **VMware Tools** and choose the **Change** option.
5. Change **Shared Folders** to **This feature will not be available**.
6. Click **Next> Modify> Finish**.
7. Restart the server.
8. Clean up the half-deleted profiles. Under **My Computer > Properties > Advanced > User Profiles**, select the profiles, and delete them. Windows informs you of any errors trying to delete the profiles.

Note: A separate issue in environments running Profile Management on VMware can result in the creation of multiple sequential profiles. For information about this issue and how to resolve it, see Knowledge Center article [CTX122501](#).

Profile Management and Outlook

August 6, 2024

This article describes best practices for integrating Microsoft Outlook with roaming profiles.

It is a good practice to ensure that users store Outlook data on a server rather than on a network share or locally.

With roaming profiles, files and folders in the location defined by the environment variable `%UserProfile%` (on the local computer) roam with users, except for one folder, `%UserProfile%\Local Settings`. This exception affects Outlook users because a Microsoft recommendation means that, by default, some Outlook data (for example, `.ost`, `.pst`, and `.pab` files) is created in this non-roaming folder.

Important: Files in this location are typically large and hinder the performance of roaming profiles.

The following practices can reduce troubleshooting of roaming profiles with Outlook and encourage good email management by users and administrators:

- If possible, use an ADM template for Microsoft Office that prohibits the use of `.pst` files.
- If users need more space, increase storage on your Microsoft Exchange servers rather than a network share.
- Define and enforce an email retention policy for the entire company (one that involves a company-wide email storage server) rather than granting exceptions for `.pst` files to individual users or increasing their personal storage capacity. The policy must also discourage reliance on `.pst` files by allowing users easily to request email restores to their inbox.
- If `.pst` files cannot be prohibited, do not configure Profile Management or roaming profiles. The **Enable search index roaming for Outlook** feature is not designed for `.pst` files.

Using Windows profiles with Password Manager and single sign-on

August 6, 2024

This article does not contain any information specific to Profile Management. It tells you how to configure certain Windows options so that Citrix Single Sign-on operates optimally with local profiles, roaming profiles, mandatory profiles, or hybrid profiles. This topic applies to Citrix Single Sign-on 4.8 or 5.0.

Local profiles

Local profiles are stored on the local server to which the user has logged on. Password Manager and single sign-on save registry information in the `HKEY_CURRENT_USER\SOFTWARE\Citrix\MetaFrame Password Manager` hive of the User Registry at:

`%SystemDrive%\Documents and Settings\%username%\NTUSER.DAT`.

Files are also saved in:

`%SystemDrive%\Documents and Settings\%username%\Application Data\Citrix\MetaFrame Password Manager`.

On Windows 7, single sign-on uses:

%APPDATA%\Roaming\Citrix\MetaFrame Password Manager

Important: It is critical that single sign-on has Full Control Access to the following files:

File Name	Description
%username%.mmf	User's credential information file with pointers to aelist.ini.
entlist.ini	Application definition file created at enterprise level in the synchronization point or Active Directory.
aelist.ini	Application definition file created by merging user's local application definition file (applist.ini) and the enterprise application definitions (entlist.ini).

Roaming profiles

Roaming profiles are saved on a network share and synchronized to a local server copy each time the user logs on. Characteristics of a successful roaming profile deployment include high-speed network connectivity such as a SAN (System Area Network) or NAS (Network Area Storage). Other common deployments include clustering solutions where the profiles are stored on high-availability servers.

Two issues affect roaming and mandatory profile deployments:

- A single roaming profile can only be used with one file synchronization point. When multiple synchronization points are used, data in the Memory Mapped File (MMF) might become corrupted.
- When roaming profiles are used with multiple concurrent sessions, they share the back-end MMF. All active sessions share some common session data such as retry lock counters, last used data counters, and event log entries.

Mandatory or hybrid profiles

Mandatory profiles are by definition user read-only profiles. Single sign-on needs write permission to the profile folder under **Application Data**. With mandatory profiles, a user might make changes but the changes are not saved back to the profile at logoff. For single sign-on to work correctly with mandatory profiles, the Application Data Folder must be redirected.

The registry changes are written each time the user logs on. Credential information is synchronized with the synchronization point but the changes are not saved back to the profile.

Beginning with Windows 2000, Microsoft provides a mechanism for redirecting the **Application Data** folder. However, using Windows NT4 domains requires logon scripts capable of modifying the location of the **Application Data** folder. You can achieve this using tools such as [Kix](#) or [VBScript](#) to define a writeable location for the **Application Data** folder.

The following example uses [Kix](#) to redirect the **Application Data** folder during user logon:

Important: This sample script is for informational purposes only. Do not use it in your environment before first testing it.

```
“ pre codeblock

$LogonServer = “%LOGONSERVER%”
$HKCU = “HKEY_CURRENT_USER”
$ShellFolders_Key =
“$HKCU\Software\Microsoft\Windows\CurrentVersion\Explorer\Shell
Folders”
$UserShellFolders_Key =
“$HKCU\Software\Microsoft\Windows\CurrentVersion\Explorer\User
Shell Folders”
$UserProfFolder =
“$LogonServer\profiles\@userID”
$UserAppData =
“$LogonServer\profiles\@userID\Application Data”
$UserDesktop =
“$LogonServer\profiles\@userID\Desktop”
$UserFavorites =
“$LogonServer\profiles\@userID\Favorites”
$UserPersonal = “X:\My Documents”
$UserRecent =
“$LogonServer\profiles\@userID\Recent”
if (exist(“$UserAppData”) = 0)
shell ‘%ComSpec% /c md “$UserAppData”
endif
if (exist(“$UserDesktop”) = 0)
shell ‘%ComSpec% /c md “$UserDesktop”
endif
if (exist(“$UserRecent”) = 0)
shell ‘%ComSpec% /c md “$UserRecent”
endif
if (exist(“$UserFavorites”) = 0)
shell ‘%ComSpec% /c md “$UserFavorites”
```

endif

““

The hybrid profile is another solution for the mandatory profile issue. When the user logs on, the mandatory profile loads and a custom application loads and unloads user registry hives based on applications available to the user. As with mandatory profiles, the user can modify those parts of the registry during a session. The difference compared with mandatory profiles is that changes are saved when the user logs off and are reloaded when they log on again.

If a hybrid profile is used, the `HKEY_CURRENT_USER\SOFTWARE\Citrix\MetaFrame Password` registry keys must be imported and exported as part of the logon and logoff process.

Folder redirection

Folder redirection is implemented using Group Policy Objects and Active Directory. It uses Group Policies to define a location for folders that are part of the user profile.

Four folders can be redirected:

- My Documents
- Application Data
- Desktop
- Start menu

Two modes of redirection can be configured using Group Policies: basic redirection and advanced redirection. Both are supported by single sign-on. In Windows 2000, you must reference the share that stores application data using the `%username%` variable (for example `\\servername\sharename\%username%`).

Folder redirection is global for the user and it affects all of their applications. All applications that use the **Application Data** folder must support it.

Read the following Microsoft articles to learn more about folder redirection:

[HOW TO: Dynamically Create Secure Redirected Folders By Using Folder Redirections](#)

[Folder Redirection Feature in Windows](#)

[Enabling the Administrator to Have Access to Redirected Folders](#)

Best practices

- Redirect the Application Data folders where possible. This approach improves network performance, eliminating the need to copy the data in those folders each time users log on.
- When troubleshooting Password Manager Agent, always verify that the logged-on user has Full Control permission on their Application Data folder.

Firefox browser

August 6, 2024

For a seamless user experience, Profile Management synchronizes each user's entire profile between the system it is installed on and the user store. As a result, Firefox users might experience slow logons or logoffs. The issue occurs because some files associated with Firefox can grow large.

We recommend you customize a logoff script to delete the following files and folders and thus to exclude them from synchronization:

- Appdata\Roaming\Mozilla\Firefox\profiles*\sessionstore.bak
- AppData\Roaming\Mozilla\Firefox\Profiles*\sessionstore-backups

The general workflow is as follows:

1. Write the logoff script using the Windows PowerShell or any other languages supported by the user computers. You can also use Windows Script Host (WSH)–supported languages and command files, including VBScript and Jscript.
2. Copy the script to the **Netlogon** shared folder on the domain controller.
3. In the **Group Policy Management Console**, associate the script to the user logoff event. For more information, see the [Microsoft article](#).

Google Chrome browser

August 6, 2024

To provide a seamless user experience, Profile Management synchronizes each user's entire profile between the system it is installed on and the user store. As a result, Google Chrome users might experience slow logons or logoffs. This issue occurs because some files associated with Google Chrome can grow large.

To improve the user experience with Google Chrome, do the following:

1. Add the following folder to the list of folders to mirror:
 - AppData\Local\Google\Chrome\User Data\Default
2. Exclude the following folders from synchronizing:
 - Appdata\Local\Google\Chrome\User Data\Default\Cache
 - Appdata\Local\Google\Chrome\User Data\Default\JumpListIconsMostVisited

- Appdata\Local\Google\Chrome\User Data\Default\JumpListIconsRecentClosed
- AppData\Local\Google\Chrome\User Data\Default\Media Cache

3. Exclude the following files from synchronizing:

- AppData\Local\Google\Chrome\User Data\Default\Favicons
- AppData\Local\Google\Chrome\User Data\Default\History
- AppData\Local\Google\Chrome\User Data\Default\Preferences
- The files unrelated to bookmarks in the `AppData\Local\Google\Chrome\User Data\Default` folder

We recommend that you use the Profile streaming feature if you experience slow logons or logoffs. For more information, see [Stream user profiles](#).

Secure

August 6, 2024

This topic contains recommended best practice for securing Profile Management. In general, secure the servers on which the user store is located to prevent unwanted access to Citrix user profile data.

Recommendations on creating secure user stores are available in the article called [Create a file share for roaming user profiles](#) on the Microsoft TechNet website. These minimum recommendations ensure a high level of security for basic operation. Also, when configuring access to the user store, include the Administrators group, which is required to modify or remove a Citrix user profile.

Permissions

Citrix tests and recommends the following permissions for the user store and the cross-platform settings store:

- Share Permissions: Full control of the user store root folder
- The following NTFS permissions, as currently recommended by Microsoft:

Group or User Name	Permission	Apply To
Creator Owner	Full Control	Subfolders and files only
	List Folder / Read Data and Create Folders / Append Data	This folder only
Local System	Full Control	This folder, subfolders, and files

Assuming inheritance is not disabled, these permissions allow the accounts to access the stores. And allow the accounts to create subfolders for users' profiles and perform the necessary read and write operations.

Beyond this minimum, you can also simplify administration by creating a group of administrators with full control of subfolders and files only. Then deleting profiles (a common troubleshooting task) becomes easier for members of that group.

If you use a template profile, users need read access to it.

Access control list (ACL)

If you use the cross-platform settings feature, set ACLs on the folder that stores the definition files as follows: read access for authenticated users, and read-write access for administrators.

Windows roaming profiles automatically remove administrator privileges from the folders containing profile data on the network. Profile Management does not automatically remove these privileges from folders in the user store. Depending on your organization's security policies, you can do so manually.

Note: If an application modifies the ACL of a file in the user's profile, Profile Management does not replicate those changes in the user store. It is consistent with the behavior of Windows roaming profiles.

Profile streaming and enterprise antivirus products

The streamed user profiles feature of Citrix Profile Management uses advanced NTFS features to simulate the presence of files missing from users' profiles. In that respect, the feature is similar to a class of products known as Hierarchical Storage Managers (HSMs). HSMs are typically used to archive infrequently used files on to slow mass-storage devices such as magnetic tape or rewritable optical storage. When such files are required, HSM drivers intercept the first file request, suspend the process making the request, fetch the file from the archive storage. And then allow the file request to continue. Given this similarity, the streamed user profiles driver, upmjit.sys, is in fact defined as an HSM driver.

In such an environment, configure antivirus products to be aware of HSM drivers, and the streamed user profiles driver is no different. To defend against the most sophisticated threats, antivirus products must perform some of their functions at the device driver level. And, like HSM drivers, they work by intercepting file requests, suspending the originating process, scanning the file, and resuming.

It is relatively easy to misconfigure an antivirus program to interrupt an HSM such as the streamed user profiles driver, preventing it from fetching files from the user store, and causing the logon to hang.

Fortunately, enterprise antivirus products are written with the possibility of sophisticated storage products, such as HSMs, in mind. And they can be configured to delay their scanning until the HSM has

done its work. Home antivirus products are less sophisticated in this respect. So the use of home and SoHo (small office/home office) antivirus products is not supported with streamed user profiles.

To configure your antivirus product for use with streamed user profiles, look for one of the following product features. Feature names are indicative only:

- **Trusted process list.** Identifies HSMs to the antivirus product, which allows the HSM to complete the file retrieval process. The antivirus product scans the file when it is first accessed by a non-trusted process.
- **Do not scan on open or status-check operations.** Configures the antivirus product to scan only a file when data is accessed (for example, when a file is executed or created). Other types of file access (for example, when a file is opened or its status checked) are ignored by the antivirus product. HSMs generally activate in response to file-open and file-status-check operations, so disabling virus scans on these operations eliminates potential conflicts.

Citrix tests streamed user profiles with versions of the leading enterprise antivirus products to ensure that they are compatible with Profile Management. These versions include:

- McAfee Virus Scan Enterprise 8.7
- Symantec Endpoint Protection 11.0
- Trend Micro OfficeScan 10

Earlier versions of these products are not tested.

If you are using an enterprise antivirus product from other vendors, ensure that it is HSM-aware. It can be configured to allow HSM operations to complete before performing scans.

Some antivirus products allow administrators to choose to scan-on-read or scan-on-write. This choice balances performance against security. The streamed user profiles feature is unaffected by the choice.

Troubleshoot Profile Management in streaming and antivirus deployments

If you encounter issues, such as logons hanging or taking a long time, there might be a misconfiguration between Profile Management and your enterprise antivirus product. Try the following procedures, in this order:

1. Check that you have the latest version of Profile Management. Your issue might already have been found and fixed.
2. Add the Profile Management service (UserProfileManager.exe) to the list of trusted processes for your enterprise antivirus product.
3. Turn off virus checking on HSM operations such as open, create, restore, or status check. Only perform virus checks on read or write operations.

4. Turn off other sophisticated virus checking features. For example, antivirus products might perform a quick scan of the first few blocks of a file to determine the actual file type. These checks match the file contents with the declared file type but can interfere with HSM operations.
5. Turn off the Windows search-indexing service, at least for the folders where profiles are stored on local drives. This service causes unnecessary HSM retrievals, and has been observed to provoke contention between streamed user profiles and enterprise antivirus products.

If none of these steps work, turn off streamed user profiles (by disabling the **Profile streaming** setting). If it works, re-enable the feature and disable your enterprise antivirus product. If it also works, gather Profile Management diagnostics for the non-working case and contact Citrix Technical Support. They need to know the exact version of enterprise antivirus product.

To continue using Profile Management, do not forget to re-enable the enterprise antivirus and turn off streamed user profiles. Other features of Profile Management continue to function in this configuration. Only the streaming of profiles is disabled.

Troubleshoot

August 6, 2024

This section provides guidance on how to troubleshoot Profile Management.

The general troubleshooting workflow is as follows:

1. [Check Profile Management settings.](#)
2. [Check Profile Management log file.](#)
3. [Check Windows events logged by Profile Management.](#)
4. [Troubleshoot common issues.](#)
5. [Perform advanced troubleshooting.](#)
6. If you can't resolve the issues after trying the preceding procedures, [collect as much diagnostic information as possible and contact Citrix Technical Support.](#)

Check Profile Management settings

August 6, 2024

As a first step in troubleshooting an issue, check the current Profile Management settings as follows:

1. Start troubleshooting in [Citrix Director](#). This console displays properties of profiles that can help you diagnose and correct problems.

2. Use the UPMConfigCheck tool to examine a live Profile Management deployment and determines whether it's optimally configured.

For more information about installing and using this tool, see Knowledge Center article [CTX132805](#).

3. If a Profile Management .ini file is in use, check its configuration on the affected machine.
4. To deactivate any Profile Management policy that you enter as lists (for example, exclusion lists and inclusion lists), set the policy to Disabled. Do not set the policy to Not Configured.
5. Check the `HKEY_LOCAL_MACHINE\SOFTWARE\Policies` registry entry on the affected machine. If there are any stale policies because of GP tattooing issues, delete them. Tattooing occurs when policies are deleted from GP but remain in the registry.
6. Check the UPMSettings.ini file, which contains the Profile Management settings that have been applied for each user. This file is present in the root folder of each Citrix user profile in the user store.

Check Profile Management log files

August 6, 2024

Log files are useful when troubleshooting system behaviors. After [checking Profile Management settings](#), enable Profile Management logging and reproduce the issue to check the log files.

Detailed steps are as follows:

1. Enable Profile Management logging for all events and actions.
2. Reproduce the issue on the machine.
3. Check the Profile Management log file (for example, #computername#. #domainname#_pm.log) in the `%SystemRoot%\system32\LogFiles\UserProfileManager` folder for errors and warnings. Locate them by searching for the word ERROR or WARNINGS respectively.

For more information about log files, see Reference, later in this article.

4. Check that the path to the user store is correct.
5. Check that all information from Active Directory was read correctly.
6. Check the time stamps to see whether there's an action that takes too long.

Tip:

You can use Microsoft Excel to review Profile Management log files. For more information, see

Knowledge Center article [CTX200674](#).

Enable Profile Management logging

Enable Profile Management logging for all events and actions only when troubleshooting an issue in your Profile Management deployment. When you have the issue resolved, disable logging and delete the log files because they might include sensitive information.

This section guides you through using GPOs and `UPMPolicyDefaults_all.ini` to enable logging for all events and actions.

You can also achieve this goal using Citrix Studio and Workspace Environment Management (WEM). For more information, see [Decide on where to centrally configure Profile Management](#).

Enable logging using GPOs

To enable Profile Management logging for all events and actions using a GPO, follow these steps:

1. Open the Group Policy Management Editor, and then create a Group Policy Object.
2. Access **Policies > Administrative Templates: Policy definitions (ADMX files) > Citrix Components > Profile Management > Log settings**.
3. Enable Profile Management logging as follows:
 - a) Double-click **Enable logging**.
 - b) Click **Enabled**.
 - c) Click **OK**.
4. Enable Profile Management to log all events and actions:
 - a) Double-click **Log settings**.
 - b) Select all events and actions. For more information about their descriptions, see Events and actions.
 - c) Click **OK**.
5. To change the default maximum size of the log file, follow these steps:
 - a) Double-click **Maximum size of the log file**.
 - b) Click **Enable**, and then enter a size in the **Maximum size in bytes** field.
 - c) Click **OK**.

Tip:

When the maximum size is reached, Profile Management retains one backup file (for example, Logfilename.log.bak).

6. Run the `gpupdate /force` command on the machine.

These policies take effect on the machine.

For more information about log setting policies, see [Profile Management policy descriptions and defaults](#).

Enable logging using the .ini file

To enable Profile Management logging for all events and actions using `UPMPolicyDefaults_all.ini`, follow these steps:

1. Open `UPMPolicyDefaults_all.ini` in the Profile Management installation folder (by default, `C:\Program Files\Citrix\User Profile Manager`).
2. Search for **Log settings** to locate the settings.

```
; Log settings
;
;LoggingEnabled=
;LogLevelWarnings=
;LogLevelInformation=
;LogLevelFileSystemNotification=
;LogLevelFileSystemActions=
;LogLevelRegistryActions=
;LogLevelRegistryDifference=
;LogLevelActiveDirectoryActions=
;LogLevelPolicyUserLogon=
;LogLevelLogon=
;LogLevelLogoff=
;LogLevelUserName=
;MaxLogSize=
;PathToLogFile=
```

3. Enter 1 for `LoggingEnabled`.
4. Enter 1 for each parameter from `LogLevelWarnings` through `LogLevelUserName`. For more information about those parameters, see Events and actions.
5. To change the default maximum size for the log file, enter a size for `MaxLogSize` as needed.
6. To change the default folder for the log file, enter a path for `PathToLogFile` as needed.

Reference

This section provides the following information:

- Log types
- Events and actions
- Fields in the Profile Management log file

Log types

This table lists logs that you can use to troubleshoot Profile Management.

Informal Name	Log File Name	Location	Type of Log Information
Profile Management log file	#computername#. #domain#_system32\logfiles\userprofilemanager.log	%SystemRoot%\system32\logfiles\userprofilemanager.log	User Profile Manager messages, warnings, and errors, are written to the Profile Management log file. The domain name is the computer's domain. If the computer name cannot be determined, this log file is called UserProfileManager.log. If the domain cannot be determined while the computer name is available, the log file is called #computername#_pm.log.
Profile Management configuration log file	#computername#. #domain#_system32\logfiles\userprofilemanager\config.log	%SystemRoot%\system32\logfiles\userprofilemanager\config.log	The config.log file captures the GPO and .ini file settings even if logging is turned off. If the computer name cannot be determined it is called UserProfileManager_pm_config. If the domain cannot be determined while the computer name is available, the log file is called #computername#_pm_config.log.

Informal Name	Log File Name	Location	Type of Log Information
Windows event log	Application.evtx	%SystemRoot%\System32\Windows\logs	The Windows events, which you view with the Microsoft Event Viewer, is used primarily for error reporting. Only errors are written to it.

Events and actions

This table lists events and actions that Profile Management can log.

Type	Description	Parameter in .ini
Common warnings	All common warnings.	LogLevelWarnings
Common information	All common information.	LogLevelInformation
File system notifications	One log entry is created each time a processed file or folder is changed.	LogLevelFileSystemNotification
File system actions	File system operations performed by Profile Management.	LogLevelFileSystemActions
Registry actions	Registry actions performed by Profile Management.	LogLevelRegistryActions
Registry differences at logoff	All registry keys in the hive HKCU that have been changed in a session. Important: This setting produces large amounts of output in the log file.	LogLevelRegistryDifference
Active Directory actions	Each time Profile Management queries the Active Directory, an entry is written to the log file.	LogLevelActiveDirectoryActions
Policy values	When the Profile Management service starts or a policy refresh occurs, policy values are written to the log file.	LogLevelPolicyUserLogon

Type	Description	Parameter in .ini
Logon	The series of actions during logon are written to the log file.	LogLevelLogon
Logoff	The series of actions during logoff are written to the log file.	LogLevelLogoff
Personalized user information	Where applicable, user and domain names are logged to dedicated columns of the log file.	LogLevelUserName

Log file fields

Each line in the Profile Management log file has several fields, separated by semicolons. This table lists the log file fields.

Field	Description
Date	Date of the log entry
Time	Time of the log entry (including milliseconds)
Severity	Either INFORMATION, WARNING, or ERROR
Domain	The domain of the user (where applicable)
User name	The name of the user (where applicable)
Session ID	The session ID (where applicable)
Thread ID	The ID of the thread that created this line
Function and description	The name of the Profile Management function running at the time, and the log message

Check Windows events

August 6, 2024

Windows events logged by Profile Management also provide diagnostic information for troubleshooting. Windows events are stored in the Application.evtx file under the `%SystemRoot%\System32\winevt\Logs\` folder.

To view the events using Windows Event Viewer, follow these steps:

1. Start **Event Viewer** on the Windows machine.
2. Select the **Windows Logs > Application** node in the left pane.

The events appear in the right pane.

List of events

Events logged by Profile Management are not all sequentially numbered and not all are used in this version of Profile Management. However, they might be logged if you upgrade from an earlier version.

Event ID	Description	Cause	Action
5	Indicates the user store that Citrix Profile Management selected on user logon and the networking latency.	The Citrix Profile Management selected a user store on user logon.	None. This message is for information only.
6	The Citrix Profile Management service has started.	The Citrix Profile Management service has started. It might be the result of an automatic start, a manual start, or a restart.	If the start or restart was not planned, check the event log for errors and take any corrective action indicated, including Profile Management troubleshooting procedures.
7	The Citrix Profile Management service has stopped.	The Citrix Profile Management service has stopped. This might be the result of a manual stop or as part of shutdown processing.	If the service stop was not planned, check the event log for errors and take any corrective action indicated, including Profile Management troubleshooting procedures.

Event ID	Description	Cause	Action
8	The profile for user has been modified by a later version of Citrix Profile Management and can no longer be used by this version...	The Citrix Profile Management service on this machine has detected that a later version of Profile Management has modified the user's profile in the user store. To prevent possible data loss, earlier versions of Profile Management revert to using a temporary profile.	Upgrade this computer (and all other computers sharing the user store and using earlier versions of Profile Management) to use the latest version.
9	The logon hook detection encountered a problem...	The Citrix Profile Management service detected a problem while setting up logon notification. The Citrix Profile Management service requires that the installation path contains no spaces, or the 8.3 file name support is enabled on the volume where the service is installed.	Reinstall Citrix Profile Management to a path with no spaces or enable 8.3 file name support on the volume where Profile Management is installed.
10	User path to the user store is...	A valid Citrix user profile has been found at the location indicated.	None. This message is for information only.
11	spsMain: CreateNamedPipe failed with...	(This event is no longer used.)	None.

Event ID	Description	Cause	Action
12	StartMonitoringProfile: A problem was detected in the Windows change journal management during logon...	The Citrix Profile Management Service was unable to monitor the profile or a folder configured for extended synchronization. A problem was detected in the Windows change journal event management, preventing the Service from monitoring changes. Citrix Profile Management does not process this folder. A Windows user profile is used instead.	Ensure that change journal processing is configured and operational for all volumes managed by Profile Management. Ensure that the computer has adequate system resources. Check the event log for errors and take any corrective action indicated, including Profile Management troubleshooting procedures.
13	StopMonitoringProfile: A problem was detected in the Windows change journal management during logoff...	The Citrix Profile Management Service was unable to stop monitoring the profile or a folder configured for extended synchronization. A problem was detected in the Windows change journal management, preventing the Service from monitoring changes. Citrix Profile Management does not process this folder. File and registry changes are not synchronized for the user.	Ensure that change journal processing is configured and operational for all volumes managed by Profile Management. Ensure that the computer has adequate system resources. Check the event log for errors and take any corrective action indicated, including Profile Management troubleshooting procedures.

Event ID	Description	Cause	Action
14	CJIncreaseSizeIfNecessary: Creating/resizing the change journal failed...	The Citrix Profile Management service was unable to monitor the profile or a folder configured for extended synchronization. A problem was detected while attempting to create or resize the NTFS change journal on a volume, preventing the service from monitoring changes. Citrix Profile Management does not process this folder. A Windows user profile is used instead.	Ensure that change journal processing is configured and operational for all volumes managed by Profile Management. Ensure that the computer has adequate system resources. Check the event log for errors and take any corrective action indicated, including Profile Management troubleshooting procedures.
15	CJInitializeForMonitoring: Unable to query the journal...	The Citrix Profile Management service was unable to monitor the profile or a folder configured for extended synchronization. A problem was detected while querying the NTFS change journal on a volume, preventing the service from monitoring changes. Citrix Profile Management does not process this folder. A Windows user profile is used instead.	Ensure that change journal processing is configured and operational for all volumes managed by Profile Management. Ensure that the computer has adequate system resources. Check the event log for errors and take any corrective action indicated, including Profile Management troubleshooting procedures.

Event ID	Description	Cause	Action
16	CJInitializeForMonitoring:Initial MFT scan finished with errors.	The Citrix Profile Management service was unable to monitor the profile or a folder configured for extended synchronization. A problem was detected while performing an initial scan of the NTFS change journal on a volume, preventing the service from monitoring changes. Citrix Profile Management does not process this folder. A Windows user profile is used instead.	Ensure that change journal processing is configured and operational for all volumes managed by Profile Management. Ensure that the computer has adequate system resources. Check the event log for errors and take any corrective action indicated, including Profile Management troubleshooting procedures.

Event ID	Description	Cause	Action
17	CJInitializeForMonitoring:Processing FS changes since service start failed.	The Citrix Profile Management service was unable to monitor the profile or a folder configured for extended synchronization. A problem was detected while performing an update scan of the NTFS change journal on a volume. This error does not prevent the service from monitoring changes. Citrix Profile Management processes this directory as normal.	Although this error does not prevent the operation of Profile Management, check for errors anyway. Make sure that change journal processing is configured and operational for all volumes managed by Profile Management. Make sure that the computer has adequate system resources. Check the event log for errors and take any corrective action indicated, including Profile Management troubleshooting procedures.

Event ID	Description	Cause	Action
18	CJProcessAvailableRecordsInternal Error...	A failure occurred in the Citrix Profile Management service while monitoring the profile or a folder configured for extended synchronization. A problem was detected while performing an update scan of the NTFS change journal on a volume, preventing the service from monitoring recent changes. Citrix Profile Management does not complete processing on this folder. Back up critical data manually.	The Citrix Profile Management Service was unable to monitor the profile or a folder configured for extended synchronization. A problem was detected in the Windows change journal event management, preventing the Service from monitoring changes. Citrix Profile Management does not process this folder. A Windows user profile is used instead.

Event ID	Description	Cause	Action
19	USNChangeMonitor: Initialization of change journal failed...	A failure occurred in the Citrix Profile Management service while monitoring the profile or a folder configured for extended synchronization. A problem was detected while preparing the initial scan of the NTFS change journal on a volume, preventing the service from monitoring changes. Citrix Profile Management does not complete processing on this directory. Back up critical data manually.	The Citrix Profile Management Service was unable to monitor the profile or a folder configured for extended synchronization. A problem was detected in the Windows change journal event management, preventing the Service from monitoring changes. Citrix Profile Management does not process this folder. A Windows user profile is used instead.
20	CADUser::Init: Determining the DNS domain and ADsPath failed...	A problem occurred while querying Active Directory for information about the logged-on user. Citrix Profile Management does not process this folder. A Windows user profile is used instead.	Ensure that the computer has a functioning network path to a domain controller. Ensure that the computer has adequate system resources. Check the event log for errors and take any corrective action indicated, including Profile Management troubleshooting procedures.

Event ID	Description	Cause	Action
21	Determining the DNS domain and ADsPath failed...	This issue can be caused by a limit on memory allocation, as described in the Microsoft TechNet article 263693.	The resolution for this issue is described in the Citrix Knowledge Center article CTX124953.
22	File access was slow. User experienced a delay while file was fetched from the user store.	The user tried to access the file but Profile Management detected a delay in this operation. The user received a warning message. This error might result from antivirus software preventing access to the file in the user store.	Consult the Profile Management documentation for troubleshooting and configuration advice on enterprise antivirus products.
23	File access might be denied. The user experienced a long delay while a file was fetched from the user store.	The user tried to access the file but Profile Management detected such a significant delay in this operation that access might be denied. The user received an error message. This error might result from antivirus software preventing access to the file in the user store.	Consult the Profile Management documentation for troubleshooting and configuration advice on enterprise antivirus products.

Event ID	Description	Cause	Action
24	RevertToSelf failed with error code and Profile Management was shut down.	Some logon and logoff processing is performed using impersonation. The RevertToSelf function is normally invoked when impersonation is complete. On this occasion, the function failed to be called. So, for security reasons, the Profile Management software was shut down. The user received an error message.	If you suspect a security breach, follow your organization's procedures to address it, and then restart Profile Management.
25	The profile for user is managed by Citrix Profile Management, but the user store cannot be reached...	The Citrix Profile Management Service on this computer cannot reach the specified user store. This is normally because of a network issue or because the server hosting the user store is unavailable.	Ensure the server hosting the user store is available and the network between this computer and the server is operational.
26	The default profile location is invalid. Profiles in this location cannot be monitored correctly...	Profiles on this computer must be on a disk mounted on a drive letter (for example, C:).	Move the profiles on this computer to a disk mounted on a drive letter, and restart Profile Management.

Event ID	Description	Cause	Action
27	The profile folder for the user is not present under the default profile location ...	In the registry, the location of this user's profile and of the default profile do not match. This can occur, for example, if profiles are moved between different volumes on the machine running the Profile Management Service.	Ensure that this user's profile is located under the default folder location. Use appropriate tools if necessary so that the profile data in the file system matches the profile's registry settings.
28	An error occurred while trying to reset security permissions on the registry hive for user.	It is likely that there are permission issues with the registry in the default or template profile used to create this Citrix user profile.	If appropriate, reset the security permissions on the user's registry hive in the Profile Management user store using a third-party utility such as SetAcl.

Event ID	Description	Cause	Action
29	A template profile path is configured but no profile was found...	The specified folder cannot be used in the template profile setting because it does not contain the file NTUSER.DAT. This issue commonly occurs when the full path of the NTUSER.DAT file is configured instead of the folder containing NTUSER.DAT. The template profile setting does not support the expansion of Active Directory attributes, system environment variables, or the %USERNAME% and %USERDOMAIN% variables.	Check that you have configured a valid path to the folder containing the template profile. Check that the path contains NTUSER.DAT. Make sure that this file is valid, and that access rights are set correctly on the folder to allow read access to all files.
33	Citrix Profile Management created a profile in the user store from a local profile at LOCATION	A profile was created in the user store from the location indicated.	None. This message is for information only.
34	Citrix Profile Management created a profile in the user store from a roaming profile at LOCATION	A profile was created in the user store from the location indicated.	None. This message is for information only.
35	Citrix Profile Management created a profile in the user store from a template profile at LOCATION	A profile was created in the user store from the location indicated.	None. This message is for information only.

Event ID	Description	Cause	Action
36	The existing profile folder for USER cannot be prepared for this user's new Citrix mandatory profile. The user is given a temporary profile if possible.	Citrix mandatory profiles use copies of a template profile for each logon. Any existing profiles are deleted and the Citrix mandatory profiles are copied from the specified template location. This process failed.	Delete any existing profile folder manually. You might have to restart the computer if files are locked by another process that causes the deletion to fail. Ensure that the template folder exists and the user has permissions to read its contents.
37	The user store path for user cannot be reached. A temporary profile is created for this user and no changes are saved to their profile in this user store.	The Citrix Profile Management Service on this computer cannot reach the specified user store. This is normally because of a network issue or because the server hosting the user store is unavailable.	Ensure the server hosting the user store is available and the network between this computer and the server is operational.

Event ID	Description	Cause	Action
38	The profile for user is managed by Citrix Profile Management, but the user store path cannot be found. A temporary profile is created for this user and no changes are saved to their profile in this user store.	The Citrix Profile Management Service on this computer cannot find the profile in the specified user store. This might be because of a network issue or because the server hosting the user store is unavailable. But it might also be because the profile in the user store has been deleted or moved. Or the path to the user store has changed and no longer correctly points to an existing profile in the user store.	Ensure that the server hosting the user store is available. And the network between this computer and the server is operational and the path to the user store points to an existing profile. If the profile in the user store has been deleted, delete the profile on the local machine.
42	An error occurred while trying to update policy settings for user <userdomain>\<username>. Policy settings might not have been applied correctly. Error code:<error code>	Citrix Profile Management failed to update Citrix group policy settings.	Verify that Citrix Group Policy Client-Side Extension is installed and works properly.

Event ID	Description	Cause	Action
3005	Attempts to mount the virtual disk from <path1> to access point <path2> fail.	Citrix Profile Management failed to mount virtual disk to the access point. This issue might occur when the virtual disk is not accessible, the access point is not empty, or the virtual disk is already mounted.	Restart the machine and check whether the issue is resolved. If not, collect CDF trace and contact Citrix Technical Support.
3008	Attempts to mount the search database from <path1> to access point <path2> fail.	Windows Search service failed to mount the search database. This issue might occur when the search database is corrupted.	Collect CDF trace and contact Citrix Technical Support.
5000	The network latency between the local host and the user store <"%3"> is <%2> milliseconds. Session ID is %1.	NA	NA
5001	The current profile size is <%1> bytes. See the event data for the session ID.	NA	NA
5002	The pending area size is <%1> bytes, comprising <%2> files, <%3> folders, with session ID <%4>, and the username <%5>.	NA	NA
5003	Sync of pending area started. Session ID: <%1>. Username: <%2>.	NA	NA

Event ID	Description	Cause	Action
5004	Sync of pending area completed. Session ID: <%1>. Username: <%2>.	NA	NA

Troubleshoot common issues

August 6, 2024

This article describes how to troubleshoot common Profile Management issues.

Slow logons

If your users encounter slow logons, follow these steps to troubleshoot:

1. Check the profile load time in the Logon Duration panel of Citrix Director. If it's substantially longer than expected, the slow logon is caused by loading user profiles.

See [Diagnose user logon issues](#) for details.

2. Check the profile processing time in the Citrix Profile Management log file.

In the Profile Management log file at `C:\Windows\System32\Log Files\User Profile Manager`, locate the entry starting with `DispatchLogonLogoff`. The following example shows that the logon processing time is 10.22 seconds.

```
DispatchLogonLogoff: ----- Finished logon processing successfully  
in [s]: <10.22>.
```

3. Make sure that you've applied the recommended Profile Management policies.

Follow the recommendations for improving logon performance in [Improve user logon performance](#).

4. Contact Citrix Technical Support.

If slow logons persist, contact Citrix Technical Support for further assistance. For more information, see [Contact Citrix Technical Support](#).

Check that profiles are being streamed

If you have enabled streamed user profiles and want to verify that this feature is being applied to a user's profile, do the following:

1. Check the following type of entry in the Profile Management log file:

```
pre codeblock 2010-03-16;16:16:35.369;INFORMATION;;;1140;ReadPolicy
: Configuration value read from policy: PSEnabled=<1>
```

The last item must be set to PSEnabled=<1> if the feature is enabled.

2. Check the following entry for the user in the Profile Management log file:

```
pre codeblock 2010-03-16;20:17:30.401;INFORMATION;<domain name
>;<user name>;2;2364;ProcessLogon: User logging on with Streamed
Profile support enabled.
```

If streamed user profiles aren't being applied, the item reads ProcessLogon: User logging on with Streamed Profile support disabled.

Determine which policies are in force

Use the UPMSsettings.ini file to determine the Profile Management policies that are being applied. This file is present in the root folder of each Citrix user profile in the user store. Examining this file might be more convenient than using the Resultant Set of Policy (RSOP). Doing so especially if you use a mixture of GPOs and .ini file settings to determine policies.

Use the UPMFRSettings.ini file to determine which profile folders aren't processed because they are on an exclusion list. The UPMFRSettings.ini file is also present in the root folder.

Exclude corrupt profile data

If a user profile is corrupt and you're confident the problem lies with a particular file or folder, exclude it from the synchronization process. The way is to add the file or folder to the exclusion list.

Clean connections to registry entries

In some scenarios (not just those involving Profile Management), connections to registry profile data are preserved after users log off. This preservation can result in slow logoffs or incomplete termination of user sessions. The User Profile Hive Cleanup (UPHClean) tool from Microsoft can help resolve these scenarios.

Delete local profiles

Microsoft Delprof.exe and Sepago Delprof2 are tools that help you delete user profiles.

Identify where profiles are stored

Diagnosing profile issues can involve locating where the files in a user's profiles are stored. The following procedure provides a quick way to identify where profiles are stored.

1. In Event Viewer, click Application in the left pane.
2. Under Source in the right pane, locate the Citrix Profile Management event of interest and double-click it.
3. The path to the user store associated with the event is displayed as a link on the General tab.
4. Follow the link to browse the user store if you want to explore the files.

Check servers

To determine whether a server is processing a user's logons and logoffs correctly, check the file called PmCompatibility.ini in the user's profile in the user store. The file is present in the profile's root folder. The last entry in the file is the name of the server from which the user last logged off. For example, if the server runs Profile Management 5.0, the entry would be:

```
1 [LastUpdateServerName]
2 5.0=<computer name>
```

Roll back

To roll back to earlier versions of Profile Management, run **del /s** from the command line on the file server that hosts the user store. The command deletes the PmCompatibility.ini file from each profile. For example, if the local path to the user store is D:\UpmProfiles, run:

```
1 del /s D:\UpmProfiles\pmcompatibility.ini
```

After the command has completed, users can log on to computers running the earlier version and receive their profile from the user store.

Profile Management running on VMware creates multiple profiles

Replicated VMware folders are created in user profiles. The replicates have incremented folder names (000, 001, 002, and so on). For more information about this issue and how to resolve it, see Knowledge Center article [CTX122501](#).

Long logon times With Novell eDirectory

When users log on to an environment having Citrix products and Novell eDirectory, long logon times might be experienced and errors written to the event log. Sessions might become unresponsive for up to 30 seconds at the **Applying your personal settings** stage. For more information about this issue and how to resolve it, see Knowledge Center article [CTX118595](#).

Excluded folders in user store

Excluded folders appear in the user store. This issue is expected and no corrective action is required. Folders on an exclusion list are created in the user store but their contents are not synchronized.

Missing information in log file

Activating debug mode does not automatically enable full logging. In log settings, verify that you've selected all check boxes for the events you want to log.

Tip: You might have to scroll down to enable the last check boxes on the list.

GPO settings inoperative

You change a GPO setting but it isn't operative on the computer running the Citrix Profile Management Service. The issue occurs because GP does not refresh immediately but instead is based on events or intervals specified in your deployment. To refresh GP immediately, run `gpupdate /force` on the computer.

For your changes to take effect, run the `gpupdate /force` command from the command prompt as documented at <https://docs.microsoft.com/en-us/windows-server/administration/windows-commands/gpupdate>.

Users receive new or temporary profiles

By default, users are given a temporary profile when a problem occurred. For example, the user store is unavailable. Alternatively, you can configure Profile Management to display an error message and then log users off. This approach can help with troubleshooting.

For instructions on configuring this feature, see [Force user logoffs](#).

In some circumstances, when they log on, users receive a new profile instead of their cached profile. For more information about this issue and a workaround for it, see Knowledge Center article [CTX118226](#).

Users might also receive a temporary profile if a local profile is present after the copy in the user store is removed. This situation can arise if the user store is cleared but local profiles are not deleted at logoff.

Profile Management treats such partial removal of profiles as a network, share, or permissions error, and provides the user with a temporary profile. For this reason, partial removal isn't recommended. To work around this issue, log on to the affected computer and delete the profile manually.

If your deployment includes personal vDisks, users might receive temporary profiles if the default processing of these disks hasn't been correctly adjusted. For more information, see [Migrate user profiles](#).

Profile data lost when virtual desktop sessions become unresponsive

In a Citrix virtual desktops deployment, disconnecting from a Remote Desktop Protocol (RDP) session can cause a virtual desktop to become unresponsive or to restart. The behavior impacts Profile Management because it causes profile data to be lost when the session ends. The issue is fixed in Citrix Virtual Delivery Agent Version 3.1.3242 and later.

Users cannot log on (Event ID: 1000, Source: Userenv)

Users are unable to log on to a Citrix environment and receive the following error message: "Windows did not load your roaming profile and is attempting to log you on with your local profile... Contact your network administrator." This error appears in Windows Application Event Logs (Event ID: 1000, Source: Userenv).

For more information about this issue and other workarounds for it, see Knowledge Center article [CTX105618](#).

Printing

In Citrix virtual desktops environments, a user can select a default printer but sometimes the selection isn't retained between logons. This issue has been observed when a Citrix virtual desktop's policy is used to set printers on pooled virtual desktops based on a Citrix Provisioning Services Personal vDisk in standard image mode.

This issue does not originate with Profile Management. Though the Profile Management log file shows that the registry entry for the printer is copied at logoff (which is expected), NTUSER.dat for the user doesn't contain the entry (which isn't expected). The issue in fact originates with the way Citrix virtual desktops uses the `DefaultPmFlags` registry setting. For more information, see Knowledge Center article [CTX119066](#).

Sometimes, unexpected printers are added to profiles. After users remove them, the printers reappear at the next logon. See the Profile Management support forum for more information.

Problems with application settings on multiple platforms

You might experience problems where application settings don't roam correctly across multiple platforms. Typically these problems result from:

- Settings that aren't applicable from one system to another. For example, hardware-specific settings that are not on every system.
- Applications that are installed differently on different systems. Examples:
 - An application that is installed on a C: drive on one system but on a D: drive on another.
 - An application that is installed in C:\Program Files on one system but in C:\Program Files (x86) on another.
 - An Excel add-in installed on one system but not on another.
- Applications that don't store setting information in the profile. For example, information stored in the local machine's settings or outside the user profile.
- Language-specific configuration settings stored in the registry. Profile Management automatically translates language-specific folder names in Version 1 profiles but not in the registry.

In most instances, better standardization of the systems that cause these issues can minimize the issues. However, often the issues result from inherent incompatibilities (with multiple platforms) of the OS or the respective application. If the problematic settings aren't critical, excluding them from the profile might resolve the issue.

Profiles owned by unknown accounts

On rare occasions, a profile can appear to belong to an unknown account. On the **Advanced** tab of the **System Properties** dialog box for a computer, Account Unknown is displayed when you click **Settings** in User Profiles. This issue comes along with an event log entry, "*Profile notification of event Create for component <application ID> failed, error code is???*" In the registry, the application ID points to the SHACCT Profile Notification Handler, a Microsoft component.

To confirm that this issue occurs in your environment, log on as a user whose data Profile Management doesn't process, and check for these symptoms.

It isn't an issue with Profile Management but might be the result of Active Directory interacting badly with virtual machine snapshots. The operation of Citrix user profiles is unaffected. Users can log on and off, and their profile changes are preserved.

Perform advanced troubleshooting

August 6, 2024

After you check the current Profile Management settings and eliminate the Profile Management logs as sources of useful information, use this checklist to troubleshoot further.

- Check the Resultant Set of Policies (RSOP) report from the machine you're analyzing and ensure all GPOs are applied as expected.

To generate the report, run the `gprestart` command on the machine.

- Check that you have the latest version of Profile Management installed. For more information, see [Check the Profile Management version](#)
- Check the [Profile Management support forum](#) for solutions from other users.
- Try to reproduce the issue on a clean machine with the same operating system as the affected machine. Install the software products one by one, and see if you can reproduce the issue after each installation. For more information, see [Deploy Profile Management in a test environment](#).

Check the Profile Management version

To examine the version information, follow these steps:

1. Right-click the `UserProfileManager.exe` file in Windows Explorer.
2. Click **Properties > Version**.
3. If it's not the latest version, download the latest version from the My Account site. Select your Citrix product and download Profile Management from the Downloads section.

Tip:

After upgrading, you can enable any later feature if needed.

Deploy Profile Management in a test environment

If logging files can't help with troubleshooting the issue, try the troubleshooting approach used in the following example. You can use this approach to:

- Determine which configuration settings are being read.
- Determine where configuration settings are being read from (when multiple ADM files are present).
- Check that the log file correctly tracks changes made to profiles.

Deployment example

Deployment in this example is as follows:

- Citrix virtual apps servers are running on Windows Server 2003.
- Users are connecting to their published resources using the Plug-in for Hosted Apps for Windows.
- OU-based GPOs are used instead of the INI file-based configuration.

Caution:

Editing the registry incorrectly can cause serious problems that might require you to reinstall the operating system. We cannot guarantee that problems resulting from improper use of Registry Editor can be solved. Use Registry Editor at your own risk. Be sure to back up the registry before you edit it.

Troubleshooting workflow

This example includes a small test OU that comprises only one server. You can edit the profile settings of the server. Then track setting changes in the log file and in the Resultant Set of Policies (RSOP) report.

Detailed steps are as follows:

1. From the production environment, remove one of the Citrix virtual apps servers that host the Citrix user profiles. Next, add the server to a new OU.
2. Remove and reinstall Profile Management on the server. When reinstalling, check that short file names (also known as 8.3 file names) are activated as follows:
 - If the following registry entry is set to 1 (DWORD value), set it to 0 and reinstall Profile Management: `HKLM\System\CurrentControlSet\Control\FileSystem\NtfsDisable8Dot3NameCreation`. Doing so enables support for short file names.
 - If the entry isn't set to 1, reinstall Profile Management to a location where each subfolder name is eight characters or less, for example, `c:\prof-man`.
For later operating systems, you do not need to adjust this registry entry.
3. Log on as a domain administrator to the server.
4. Examine the local policy and remove the ADM file at this level.
5. Delete any links to GPOs assigned to your new OU.
6. On the server, delete the key and all subkeys from Registry Editor: `HKEY_LOCAL_MACHINE\SOFTWARE\Policies\Citrix\UserProfileManager\`.

7. Remove any Profile Management .ini file.
8. Using **My Computer > Properties > Advanced**, delete all profiles except those profiles that you want to test. Research any errors that appear.
9. Grant the Authenticated Users group full control of the file. Doing so enables you to check the Profile Management log file when logging on as a user. The log file is C:\Windows\System32\LogFiles\UserProfileManager\- 10. Create a GPO that contains only the following settings, and then link it to your new OU. Make sure that the GPO is assigned to the Authenticated Users group. Enabled and configure these settings:
 - a) Enable Profile Management.
 - b) Path to user store.
 - c) Enable logging.
 - d) Log settings. Select all events and actions.
 - e) Migration of existing profiles. Select Roaming and local profiles.
 - f) Local profile conflict handling. Select Rename local profile.
 - g) Delete locally cached profiles on logoff.
 - h) Disable the *Process logons of local administrators* setting. By doing so, even if Profile Management is misconfigured and prevents user logons, you can still log on as an administrator.
- 11. Control how the GPO link is applied to the OU by right-clicking the OU and selecting **Block Inheritance**.
- 12. Create a domain test user who has never logged on and isn't a member of any local administrator group on the server.
- 13. Publish a full desktop to this user and make sure that the user is in the Remote Desktop Users group.
- 14. If the domain has multiple domain controllers (DCs), force AD replication between all DCs in the same site as the server.
- 15. Log on to the server as domain Administrator, delete the log file, restart the Citrix Profile Management service, and run `gpupdate /force`.
- 16. Check the registry and make sure the only values in `HKEY_LOCAL_MACHINE\SOFTWARE\Policies\Citrix\UserProfileManager\` are the ones for your new GPO.
- 17. Log out as Administrator.
- 18. Make some setting changes to Internet Explorer, and create a blank test file in your My Docs folder.

19. Create a shortcut to the Profile Management log file. Open it and examine the entries. Research any items that require attention.
20. Log out and then back in as domain Administrator.
21. Generate a RSoP report for the test user and the server by running `gpresult`.

If the report doesn't include what you expect, research any items that require attention.

Contact Citrix Technical Support

August 6, 2024

If you've checked the troubleshooting advice in this section and believe the problem that you experienced results from Profile Management, contact Citrix Technical Support. Always collect and provide the following files and as much other information as possible.

Collect Profile Management log files

Detailed steps are as follows:

1. Enable Profile Management on the machine to log all events and actions. For more information, see [Enable Profile Management logging](#).
2. Reproduce the problem on the affected machine.
3. Collect the Profile Management log file and its backup file from `%SystemRoot%\System32\Logfiles\UserProf`

The log file from the affected machine includes at least the following information:

- Start of the service (including the version and the build number of Profile Management)
- Reading of the configuration by the service
- One full logon process of the affected user
- The activity the user did when the issue occurred
- One full logoff process for the affected user

Collect the Windows event log file

After you reproduce the problem on the affected machine, follow these steps to collect the Windows event log file.

1. Locate the `%SystemRoot%\System32\winevt\Logs` folder.
2. Collect the `Application.evtx` file.

Collect installed software details

Collect details of the following software installed on the affected machine:

- Operating system, language, and version.
- Citrix products and versions.

Collect .ini files

Follow these steps to collect .ini files associated with Profile Management:

1. Locate the root folder of each Citrix user profile in the user store.
2. Collect the following .ini files:
 - UPMSettings.ini
 - UPMFRSettings.ini
 - PmCompatibility.ini

Collect the Always On Tracing log file

The Always On Tracing (AOT) logs provide information that can help identify critical problems with Profile Management, thus reducing the need to reproduce problems.

To collect the AOT log files, follow these steps:

1. On the machine where problems occurred, go to `C:\ProgramData\Citrix\TelemetryService\CitrixAOT`. You can see all AOT log files.

Note:

If the machine is installed with other Citrix components where AOT is enabled, the AOT log files also contain logs from those components.

2. To manually generate the latest log file, follow these steps:
 - a) Run **Windows PowerShell** as an administrator.
 - b) Run the command: `Restart-Service -Name "Citrix Telemetry Service"`
3. Collect all AOT log files and send them to Citrix Technical Support.

Collect a diagnostic track log using CDFControl

Collect a diagnostic trace log using the CDFControl as follows:

1. Download the CDFControl tool from Knowledge Center article [CTX111961](#).
2. Run the CDFControl executable.
3. In the window that appears, select one or more tracing modules as needed. For more information about their function descriptions, see the following table.
4. Click **Start Tracing**.
5. Reproduce the problem.
6. Click **Stop Tracing**.
7. Find your trace log in the same folder as the CDFControl executable.

This table lists the functions of track modules in CDFControl.

Trace Module	Description
UPM_DLL_GPCSE	Traces the user group policy evaluation request sent from Profile Management to the Citrix Group Policy client-side extension.
UPM_DLL_OUTLOOK_HOOK	Traces the Profile Management hook module in Outlook. Select it to trace issues with the Outlook search index Roaming feature.
UPM_DLL_Perfmon	Traces Windows Performance Monitor counters associated with Profile Management and errors generated by Profile Management.
UPM_DLL_SearchSvc_Hook	Traces the Profile Management hook module in Windows Search Service. Select it to trace issues with the Outlook search index Roaming feature.
UPM_DLL_WfShell	Traces the Profile Management <code>wfshell</code> plug-in, which reports the desktop-ready event for published applications.
UPM_Driver	Traces file-system changes each time the Citrix streamed user profiles driver is used.
UPM_Service	Traces information each time the Profile Management Service is called. Example occasions include at logon, at logoff, or when mid-session synchronization or periodic maintenance takes place.

Trace Module	Description
UPM_SessionLaunchEvaluation	Traces the launch events associated with the unique transaction ID in Profile Management.
UPM_WMI	Traces the Profile Management VDA WMI plug-in events.

Collect other information

Collect the following information if possible:

- The Resultant Set of Policy (RSOP) report for the affected machine and user by running the `gpresult` command.
- Application event logs.
- If available, the **Userenv** debug file. Consult your Microsoft documentation for information on this tool.

Notes:

Data collection can become complex if Citrix Provisioning Services is part of your deployment and the problem occurs when profiles are being initialized. In that scenario, make the preceding configuration updates in the .ini file (and disable the GPO log settings). We recommend you follow the instructions in [Preconfigure Profile Management on provisioned images](#).

Best practices

August 6, 2024

A Windows user profile is a collection of folders, files, registry, and configuration settings defining the environment for a user who logs on with a particular user account. Users can customize these settings depending on the administrative configuration.

Configure Profile Management from one location

There are three locations from which you can configure Profile Management. To configure Profile Management, use one of the following ways:

- A GPO in Active Directory

- Policies in Citrix Studio
- Workspace Environment Management

We recommend that you choose only one of the three locations to configure Profile Management.

Watch this video to learn more:



Cookie handling

Profile Management supports deleting stale cookies for Internet Explorer 10 and Internet Explorer 11. You can use the **Process Internet cookie files on logoff** policy to delete stale cookies to avoid cookie folder bloat. In addition, add the following folders to the list of folders that you want to mirror:

- AppData\Local\Microsoft\Windows\INetCookies
- AppData\Local\Microsoft\Windows\WebCache
- AppData\Roaming\Microsoft\Windows\Cookies

Outlook and Office 365

Microsoft recommends Cached Exchange Mode so that a consistent online and offline Microsoft Outlook experience is enabled. You can turn on the Cached Exchange Mode from the Microsoft Outlook client. For more information, see <https://docs.microsoft.com/en-us/exchange/outlook/cached-exchange-mode>.

When you use Cached Exchange Mode, there is always a copy of a user's Exchange mailbox in an Offline Outlook Data File (*.ost). The file can grow large.

We recommend avoiding storing Microsoft Outlook data locally or on shared drives. Use the Enable native Outlook search experience feature instead. With this feature, the Offline Outlook Data File (*.ost) and the Microsoft search database specific to the user roam along with the user profile. This feature improves the user experience when searching mail in Microsoft Outlook. For more information on using this feature, see [Enable native Outlook search experience](#).

Profile streaming with Microsoft Credentials Roaming enabled

By default, the following folders in the configuration file are excluded from profile streaming:

- AppData\Local\Microsoft\Credentials
- Appdata\Roaming\Microsoft\Credentials
- Appdata\Roaming\Microsoft\Crypto
- Appdata\Roaming\Microsoft\Protect
- Appdata\Roaming\Microsoft\SystemCertificates

If you configure profile streaming exclusion manually, ensure to add the preceding folders to “Profile streaming exclusion list-directories.”

Start menu roaming

Applications pinned to the Start menu might disappear on the following operating systems after several logons:

- Windows 10 Version 1607 and later, 32-bit and 64-bit
- Windows Server 2016 Standard and [Datacenter](#) editions
- Windows Server 2019 Standard and [Datacenter](#) editions
- Windows 10 Enterprise for Virtual Desktops

Note:

You cannot use the same policy for both Windows 10 and Windows Server 2016/2019. Configure separate policies for VDI and shared desktop platforms, or if using Profile Management 2103 or later, use automatic configuration.

Automatically enable Start menu roaming

If you're using Profile Management 2103 or later, when you leave the **Disable automatic configuration** policy at its default value (**Disabled**), *Start menu roaming* is automatically enabled.

If you are using Profile Management 2106 or later, we recommend you enable the **Accelerate folder mirroring** policy, which is located under **Profile Management > File system > Synchronization**. This setting provides better user logon and logoff experience for the folder mirroring feature. For more information, see [Accelerate folder mirroring](#).

Manually enable Start menu roaming for Windows 10

When the **Disable automatic configuration** policy is enabled, you can use the following steps to manually enable *Start menu roaming* for Windows 10:

1. Go to **Profile Management > File system > Synchronization**.
2. Set the **Folders to mirror** policy to **Enabled**, and then add the following folders to the list of folders to mirror:
 - `Appdata\Local\Packages`
 - `Appdata\Local\Microsoft\Windows\Caches`
 - `!ctx_localappdata!\TileDataLayer` (applicable only to Windows 10 version 1607 and earlier)

Note:

Starting with Citrix Profile Management 1912, a folder added to **Default exclusion list – directories** or **Exclusion list – directories** cannot be synchronized even if you add it to **Folders to mirror**. If one of these folders or their parent or ancestor folders are in the exclusion lists, add it to the **Directories to synchronize** list.

3. Set the **Files to synchronize** policy to **Enabled**, and then add the following file to the list of files to synchronize.
 - `Appdata\Local\Microsoft\Windows\UsrClass.dat*`

Manually enable Start menu roaming for Windows Servers

When the **Disable automatic configuration** policy is enabled, you can use the following steps to manually enable *Start menu roaming* for Windows Servers:

1. Go to **Profile Management > Advanced settings**, and then set the **Disable automatic configuration** policy to **Enabled**.

2. Go to **Profile Management > File system > Synchronization**.
3. Set the **Folders to mirror** policy to **Enabled**, and then add the following folders to the list of folders to mirror:

- Appdata\Local\Packages
- Appdata\Local\Microsoft\Windows\Caches

Note:

Starting with Citrix Profile Management 1912, a folder added to **Default exclusion list – directories** or **Exclusion list – directories** cannot be synchronized even if you add it to **Folders to mirror**. If one of these folders or their parent or ancestor folders are in the exclusion lists, add it to the **Directories to synchronize** list.

4. Set the **Files to synchronize** policy to **Enabled**, and then add the following file to the list of files to synchronize.

- Appdata\Local\Microsoft\Windows\UsrClass.dat*

Synchronize profiles efficiently

Insufficiently synchronized user profiles can result in slow logons, losses of user settings, and profile corruption. It can also need excessive administrative efforts. To synchronize profiles efficiently, follow the recommendations described in this article.

Folder redirection

Folder redirection is a feature of Microsoft Windows that you can use with Profile Management. Folder redirection plays a key role in delivering a successful profile solution.

To use folder redirection, ensure that the relevant users are in the OU that Profile Management manages. We recommend that you configure folder redirection using a GPO in Active Directory.

For example, you can redirect the following folders by enabling the corresponding policies under **User Configuration > Administrative Templates > Classic Administrative Templates (ADM) > Citrix > Profile Management > Folder Redirection**:

Documents, Pictures, Music, Videos, Favorites, Contacts, Downloads, Links, Searches, and Saved Games

Note:

- Folder redirection eliminates the need to copy the data in those folders each time users log on and thus accelerates user logons.

- We strongly recommend not enabling **Folder Redirection** for **AppData (Roaming)** and **Start Menu** because it might cause issues in applications and the Start menu.
- Do not redirect the **Desktop** folder if it is too large. Otherwise, a black screen might occur when a user logs on.

Include and exclude files and folders

Profile Management lets you specify files and folders that you do not want to synchronize by customizing inclusion and exclusion lists. To avoid profile bloat, exclude cache files for third party applications, for example, Chrome cache files located at Appdata\Local\Google\Chrome\UserData\Default\Cache. For more information, see [Include and exclude items](#).

Profile streaming

Profile Management fetches files in a profile from the user store to the local computer only when users access them after they log on. Doing so speeds up the logon process and reduces the profile size. For example, if a file is not used, it is never copied to the local profile folder. You can also use the **Always cache** policy to impose a lower limit on the size of files that are streamed. Any file this size or larger is cached locally as soon as possible after logon.

You can enable both the **Enable profile streaming for folders** and the **Profile streaming** policies to eliminate the need to fetch folders that are not accessed.

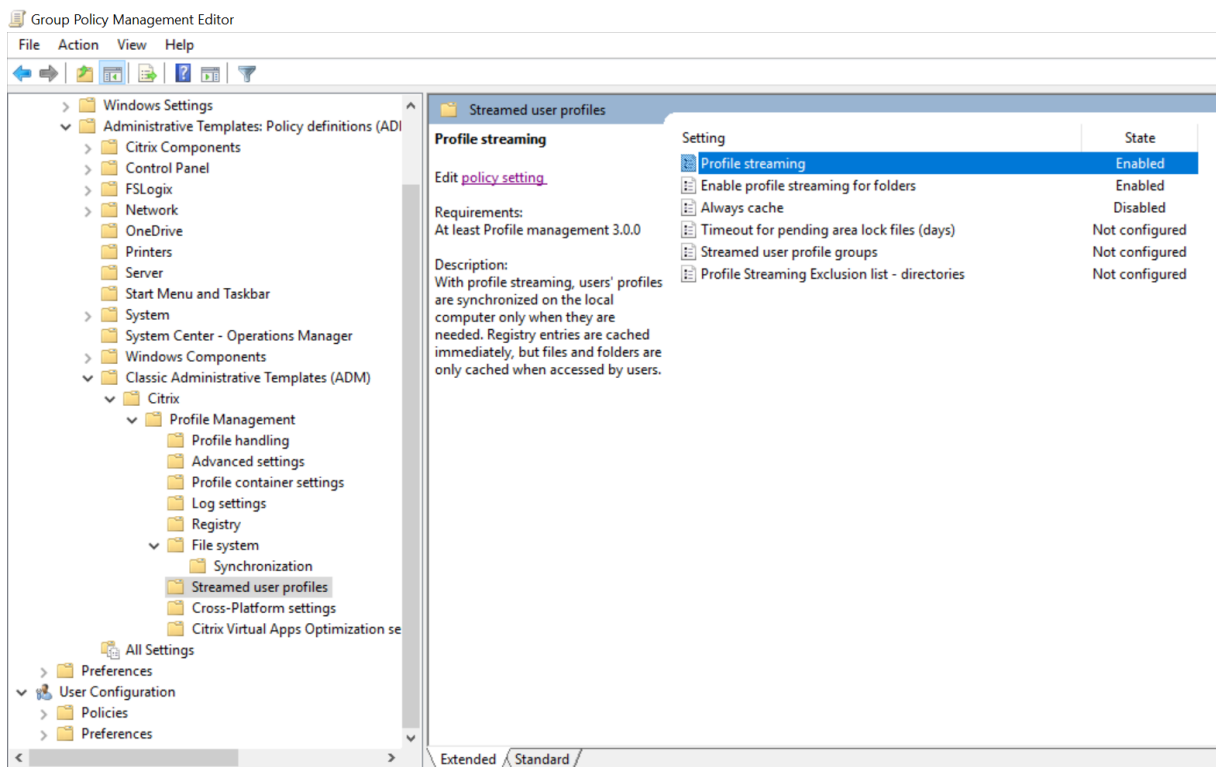

Active Write Back and Registry

This feature decreases logoff times compared to the Profile streaming feature, especially when there are many changed files. This feature synchronizes modified files and folders (but not registry entries) to the user store during the session, but before logoff.

Internet Explorer 10/11 cookie support

Profile Management 5.0 and later supports enhanced processing for cookies when using Internet Explorer 10 and Internet Explorer 11. To avoid cookie folder bloat, use the Process Internet cookie files on logoff policy to delete stale cookies. You can add the following folders to the list of folders to mirror:

- AppData\Local\Microsoft\Windows\INetCookies
- AppData\Local\Microsoft\Windows\WebCache
- AppData\Roaming\Microsoft\Windows\Cookies

For more information, see [Process Internet cookie files on logoff](#).

Troubleshooting best practice

Always use the Profile Management configuration checker tool (UPMConfigCheck) to identify potential configuration errors. For more information on this tool, see Knowledge Center article [CTX132805](#).

When Profile Management does not work, first validate whether the User Store configured is accessible.

Windows 10 Start menu customization

We recommend using a partial lockdown customization layout and deploying the customization through Group Policy. For more information about customizing the layout of the Start menu, see <https://docs.microsoft.com/en-us/windows-hardware/customize/desktop/customize-start-layout>.

Improve user logon performance

August 6, 2024

Profile Management provides various policies to improve user logon performance. Examples include the **Streamed user profiles**, **Accelerate folder mirroring**, and **Profile container** policies. These policies are helpful in scenarios where user profiles keep growing with daily use.

This section provides two Profile Management solutions that let you improve user logon performance.

Enable streamed profiles and accelerate folder mirroring

After deploying the user store in your environment, enable the following policies to improve user logon performance:

1. Go to **Profile Management > Streamed user profiles**, and then enable **Profile streaming** and **Enable profile streaming for folders**.
2. Go to **Profile Management > File system**, and then enable **Accelerate folder mirroring**.

Enable the profile container for the full profile

You can deploy the VHDX-based Citrix profile solution (called profile container) to improve logon performance. Those VHDX files are dynamically attached on user logons.

To deploy the VHDX-based solution, enable the profile container to store the full user profile as follows:

1. Go to **Profile Management > Profile container settings**.
2. Enable **Profile container** and enter an asterisk (*) to the profile container list.

Performance comparisons

We recommend the preceding solutions based on our tests with a typical user profile. For more information, see Knowledge Center article [CTX463658](#). As shown in the following tables, user logon and logoff times dropped significantly after we deployed either solution.

Test results of enabling the **Streamed user profiles** and **Accelerating folder mirroring** policies:

Parameters	Before	After
Logon time / Total logon time	53.81 s / 56.48 s	1.80 s / 4.45 s
Logoff time / Total logoff time	42.49 s / 43.67 s	5.62 s / 6.89 s

Test results of enabling the **Profile container** policy for the full profile:

Parameters	Before	After
Logon time / Total logon time	53.81 s / 56.48 s	2.66 s / 5.26 s
Logoff time / Total logoff time	42.49 s / 43.67 s	3.63 s / 4.99 s

Save storage space using file deduplication

August 6, 2024

Identical files can exist in various user profiles in the user store. For example, different users download the same file or install the same software into their user profiles. With the **File deduplication** policy, Profile Management moves duplicate instances of files from the user store to a central location (called *shared store*) and deletes the other. Therefore, your storage cost is reduced.

Prerequisites

To enable file deduplication, make sure that you:

- Use **%username%** or **#samaccountname#** in the **Path to user store** setting so that the shared store can be created automatically.
- Install Citrix Profile Management version 2209 or later.

Enable and configure the File deduplication policy

Take the Workspace Environment Management (WEM) web console for an example. To enable and configure file deduplication using the console, follow these steps:

1. Go to **Profiles > Profile Management Settings > File deduplication**.
2. Select **Enable file inclusions** and specify files to deduplicate. If needed, select **Enable file exclusions** and specify files to exclude from the included files. See [Enable file deduplication](#) for more details.

We recommend deduplicating only files that change infrequently, such as:

- Program files that users install:

```
AppData\Local\Microsoft\Teams\*.exe,      AppData\Local\Microsoft\
Teams\*.dll, AppData\Local\Microsoft\OneDrive\*.exe, AppData\Local\
Microsoft\OneDrive\*.dll
```

- Installer or image files that users download:

`Downloads*.exe, Downloads*.msi, Downloads*.iso`

We don't recommend deduplicating the following files:

- Documents that users might edit frequently:

`Documents*.xlsx, Documents*.docx`

- Data files that might change frequently:

`AppData\Local*.dat`

Note:

The effect of file deduplication can vary with the user environments and the files you specify for deduplication. We recommend customizing file settings based on the actual situations.

Change permission settings

When creating the shared store folder, Profile Management grants the folder to the following principals:

- Domain computers (with Full control access)
- Domain users (with Read access)

With these default permission settings, file deduplication works only on domain-joined machines. For it to work on non-domain-joined machines, you must assign those machines with a user account that has Full control access to the shared store folder. Detailed steps are as follows:

1. On the shared store server, grant a user account (for example, `admin0`) Full control access to the shared store folder.
2. On each VDA, add a Windows credential for the `admin0` user account to sign in to the shared store folder. To do so, use Windows Credential Manager or Workspace Environment Management. See the procedures described in [Enable credential-based access to user stores](#) for details.
3. (Optional) On the shared store server, locate the shared store folder and remove the permission entry for domain computers.

Support for data changes to deduplicated files

This feature can handle data changes to deduplicated files. For example, two users install software XYZ version 1 and you include it for file deduplication. Later, one user upgrades to version 2, Profile Management creates a new version of files in the shared store. When the other user also upgrades to version 2, Profile Management deletes the old version files.

Glossary

August 6, 2024

This article lists terms and definitions used in the Profile Management software and documentation. Profile-related terms used in other Citrix software are also included. To understand other concepts relating to Windows user profiles, visit the Microsoft website.

Term	Definition
Base platform	See cross-platform settings store.
Base profile	The base profile is defined by a UNC path to a profile in the user store. If the cross-platform settings feature is used, registry settings and files that can be shared across platforms from a subset of the base profile. This subset is copied to the cross-platform settings store, and, from there, they are added to the profile used as the target for migration or roaming. Although the cross-platform settings store contains a subset of the base profile, this (and the target profile) is always stored as complete profiles. And it can, if necessary, be used as standard Windows roaming or local profiles. Note however that if the streamed user profiles feature is used, the base profile might temporarily be incomplete. Some files might exist in the pending area until the user logs off. See roam for considerations when defining base profiles in roaming scenarios.
Cache	The terms cache and synchronize refer to the act of downloading files from the user store, or uploading to it. The term fetch is more specific and refers to how the streamed user profiles feature downloads, anytime after logon when the user needs them, a subset of files from the user store.

Term	Definition
Citrix mandatory profile, Citrix roaming profile, Citrix user profile	<p>Citrix user profile is the general term for the profile that a user receives when Profile Management is installed and enabled. There are two types of Citrix user profiles: Citrix roaming profiles and Citrix mandatory profiles. A Citrix roaming profile is the standard collection of files, folders, and registry settings that users customize in their day-to-day work, that are saved in the user store at logoff, and that are treated by Profile Management policies. A Citrix mandatory profile is similar to a Citrix roaming profile in how Profile Management treats them. But no changes are saved in the user store at logoff. At logons, a fresh copy of the mandatory profile is loaded. Citrix user profiles are different from Microsoft local, Microsoft roaming, or Microsoft mandatory profiles.</p>
Computer	<p>As used in these Profile Management topics, the general term computer can refer to any machine on which the Citrix Profile Management Service is installed. It can be a user device, virtual desktop (possibly provisioned from a Citrix Virtual Desktops virtual machine), or a Citrix virtual apps server that hosts published applications.</p>
Cross-platform definition file	<p>This file is an .xml file supplied with Profile Management that contains the information needed to make the cross-platform settings feature work. There is one file per supported application.</p>
Cross-platform settings store	<p>This location, which is separate from the user store, holds the settings for supported applications once the cross-platform settings feature is configured. Choose which platform's profile data is used to seed the cross-platform settings store. It is the base platform.</p>
Fetch	See cache.

Term	Definition
Legacy application	A legacy application is a badly behaved one because it stores settings in a non-standard location. It includes systems that store temporary application data in user profiles and, by doing so, create profile bloat.
Migrate	Migration is the planned, one-way movement of profiles from one platform to another (for example, from Windows XP to Windows 7).
Profile bloat	Windows user profiles can increase in size when temporary files are not deleted. It causes slow logons and is referred to as profile bloat.
Roam	Roaming is the use of different base profiles from multiple computers or sessions (for example, one base profile for a computer running Windows 2008 R2 and a second one for Windows 7). Users roam when they connect back and forth between computers or sessions that have different base profiles. Depending on how you configure your Organizational Units (OUs), a base profile can be shared across platforms. For example, both Windows 2008 R2 and Windows 7 OUs can use the same profile. In this case, users do not roam because the same base profile is shared. Base profiles can only be shared by operating systems with the same profile version (Version 1 or Version 2 profiles). Users always roam when both Version 1 and Version 2 profiles are active.
Synchronize	See cache.
User store	The user store is the central, network location for storing Citrix user profiles. See also cross-platform settings store.

Term	Definition
vDisk, Personal vDisk	A vDisk is a virtual disk created from a master image by Citrix Provisioning Services. A Personal vDisk is a disk used by Citrix virtual desktops to store profiles, user-installed and departmental applications, and user data. Personal vDisks are separate from the disks used for the operating system, registry, and base applications.
Version 1 profile, Version 2 profile	Profiles in Microsoft Windows XP and Windows Server 2003 are known as Version 1 profiles. Those profiles in Windows Vista, Windows 7, Windows Server 2008, and Windows Server 2008 R2 are known as Version 2 profiles. Version 1 and Version 2 profiles have different namespaces, which affects some aspects of their configuration.



© 2024 Cloud Software Group, Inc. All rights reserved. Cloud Software Group, the Cloud Software Group logo, and other marks appearing herein are property of Cloud Software Group, Inc. and/or one or more of its subsidiaries, and may be registered with the U.S. Patent and Trademark Office and in other countries. All other marks are the property of their respective owner(s).