

XenMobile Server

Jul 05, 2017

Current release: XenMobile Server 10.6

XenMobile Server is an on-premises enterprise mobility management solution that offers mobile device management (MDM) and mobile application management (MDM) capabilities.

The cloud service version of XenMobile Server is called XenMobile Service.

The XenMobile Apps are productivity and communication apps that are offered as a part of the XenMobile solution.

For information specific to the XenMobile cloud offering, see [XenMobile Service](#). For information about the XenMobile Apps, see [XenMobile Apps](#).

For the XenMobile Server and apps, Citrix supports the current and prior two versions of XenMobile. For a list of new features, known and fixed issues in the prior two versions, see:

- [What's new in XenMobile Server 10.5](#)
- [What's new in XenMobile Server 10.4](#)

For PDFs of the documentation for all versions earlier than the most recent version, see the [Archive List of Legacy Documents](#).

XenMobile 9. This version reached the End of Life (EOL) lifecycle status as of June 30, 2017. When a product release reaches EOL, you can use the product within the terms of your product licensing agreement, but the available support options are limited. Historical information appears in the Knowledge Center or other online resources. The documentation is no longer updated and is provided on an as-is basis. For more information about product lifecycle milestones, see the [Product Matrix](#).

For five years beyond the EOL date, you can download a PDF of the XenMobile 9 documentation from the [Archive List of Legacy Documents](#).

For more information about moving from XenMobile 9 XenMobile 10.x or to XenMobile Service via Citrix Cloud, see this [Citrix.com](#) page.

Upgrades

Important

Before you upgrade to XenMobile 10.6 (on-premises)

1. If the virtual machine running the XenMobile Server to be upgraded has less than 4 GB of RAM, increase the RAM to at least 4 GB. Keep in mind that the recommended minimum RAM is 8 GB for production environments.
2. For upgrades from XenMobile 10.4 or earlier: Make a note about your configurations for the Passcode and Restrictions device policies for Windows tablets. Those policies are no longer based on WMI. As a result, the upgrade removes the existing configurations. After the upgrade, reconfigure the Passcode and Restrictions device policies for Windows tablets.

3. If you have the deprecated Enterprise Data Protection device policy configured, delete the policy before upgrading.

You can directly upgrade to XenMobile 10.6 from XenMobile 10.5, 10.4, or 9.0. You have these options for upgrading to XenMobile 10.6:

- **To upgrade from XenMobile 10.5 or XenMobile 10.4 to XenMobile 10.6.** Use the **Release Management** page in the XenMobile console. You do not use the Upgrade Tool to upgrade XenMobile 10 installations.

To perform the upgrade, you use `xms_10.6.0.22` bin. In the XenMobile console, click the gear icon in the upper-right corner of the console and then click **Release Management**. Click **Upgrade** and then upload the BIN file. Upgrade files for supported hypervisors are:

```
xms_10.6.0.22.xenserver.xva
xms_10.6.0.22.HyperV.zip
xms_10.6.0.22.vmware.ova
```

- **To upgrade from XenMobile 10.3.6 to XenMobile 10.6.** Use the **Release Management** page in the XenMobile console to upgrade in the following sequence. You do not use the Upgrade Tool for these installations.
 - Upgrade from XenMobile 10.3.6 to XenMobile 10.5.
 - Upgrade from XenMobile 10.5 to XenMobile 10.6.
- **To upgrade from XenMobile 10 or 10.1 to XenMobile 10.6.** First, use the **Release Management** page in the XenMobile console to upgrade in the following sequence. You do not use the Upgrade Tool for these installations.
 - Upgrade from XenMobile 10 or 10.1 to XenMobile 10.3.5
 - Upgrade from XenMobile 10.3.5 to XenMobile 10.4.
 - Upgrade from XenMobile 10.4 to XenMobile 10.6.
- **To upgrade from XenMobile 9.0 to XenMobile 10.6.** Use the XenMobile Upgrade Tool that is built in to the latest XenMobile release. The Upgrade Tool supports all XenMobile 9 editions: MDM, App, and Enterprise.

For information about upgrading, see [Upgrade](#) and its subarticles.

To complete a new installation of the latest release of XenMobile, see [Install and configure](#).

Related information

[XenMobile Support Knowledge Center](#)
[Citrix Blogs: XenMobile July Highlights](#)

What's new in XenMobile Server 10.6

Aug 17, 2017

For information about upgrading, see [Upgrade](#). To access the XenMobile management console, use only the XenMobile Server fully qualified domain name or the IP addresses of the node.

XenMobile Server 10.6 includes the following new features. For information about bug fixes, see [Fixed issues](#).

Important

Touchdown by Symantec reached End of Life on July 3, 2017, with End of Standard Support, End of Extended Support, and End of Support Life on July 2, 2018. For more information, see the Symantec support article, [Touchdown End-of-Life, End-of-Availability, and End-of-Support announcement](#).

Improved deployment of required apps

XenMobile now consistently and promptly installs required apps on managed iOS and Android devices. This improvement resolves deployment issues that occurred primarily for XenMobile configured in enterprise (XME) mode. Users more promptly receive updates in situations, such as:

- You upload a new app and mark it as required.
- You mark an existing app as required.
- As user deletes a required app.
- A Secure Hub update is available.

Requirements

- XenMobile Server 10.6
- Secure Hub (minimum versions: 10.5.15 for iOS; 10.5.20 for Android)
- MDX Toolkit 10.6
- Custom server property, `force.server.push.required.apps`.

The forced deployment of required apps is disabled by default. To enable the feature, create a Custom Key server property. Set the **Key** and **Display name** to `force.server.push.required.apps` and set the **Value** to `true`.

- After you upgrade XenMobile Server and Secure Hub: Users with enrolled devices must sign off and then sign on to Secure Hub, one time, to obtain the required app deployment updates.

Examples

The following examples show the sequence of adding the Secure Tasks app to a delivery group and then deploying the delivery group.

XenMobile Analyze Manage Configure admin

Device Policies Apps Actions ShareFile Enrollment Profiles **Delivery Groups**

Delivery Group

- 1 Delivery Group Info
- 2 User
- 3 Resource (optional)
- 4 Summary

Apps

Drag the apps that you want to include in the delivery group.

Enter app name

Apps

- Angry Bird
- Box
- Fit
- SecureNotes

Required Apps

- SecureWeb
- Enterprise-01
- GTM
- SecureTask

Optional Apps

- Jira
- Office365_SAML

XenMobile Analyze Manage Configure admin

Device Policies Apps Actions ShareFile Enrollment Profiles **Delivery Groups**

Delivery Groups

Show filter

<input type="checkbox"/>	Status	Name	Last Updated	Disabled
<input type="checkbox"/>		AllUsers	Apr 18 2017 2:43 AM	
<input checked="" type="checkbox"/>		DeliveryGroup-01	Apr 19 2017 8:47 AM	

Showing 1 - 2 of 2 items Items per page:

After the sample app, Secure Tasks, deploys to the user device, Secure Hub prompts the user to install the app.

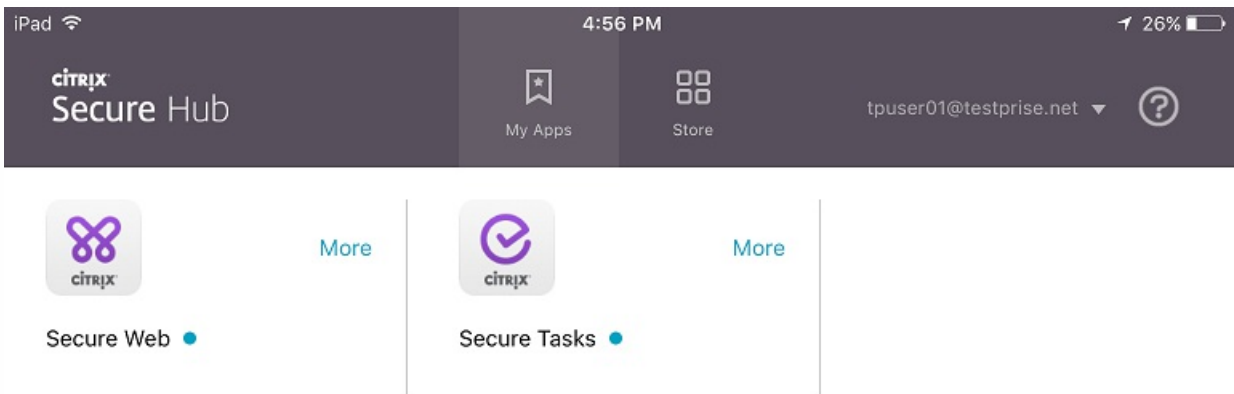
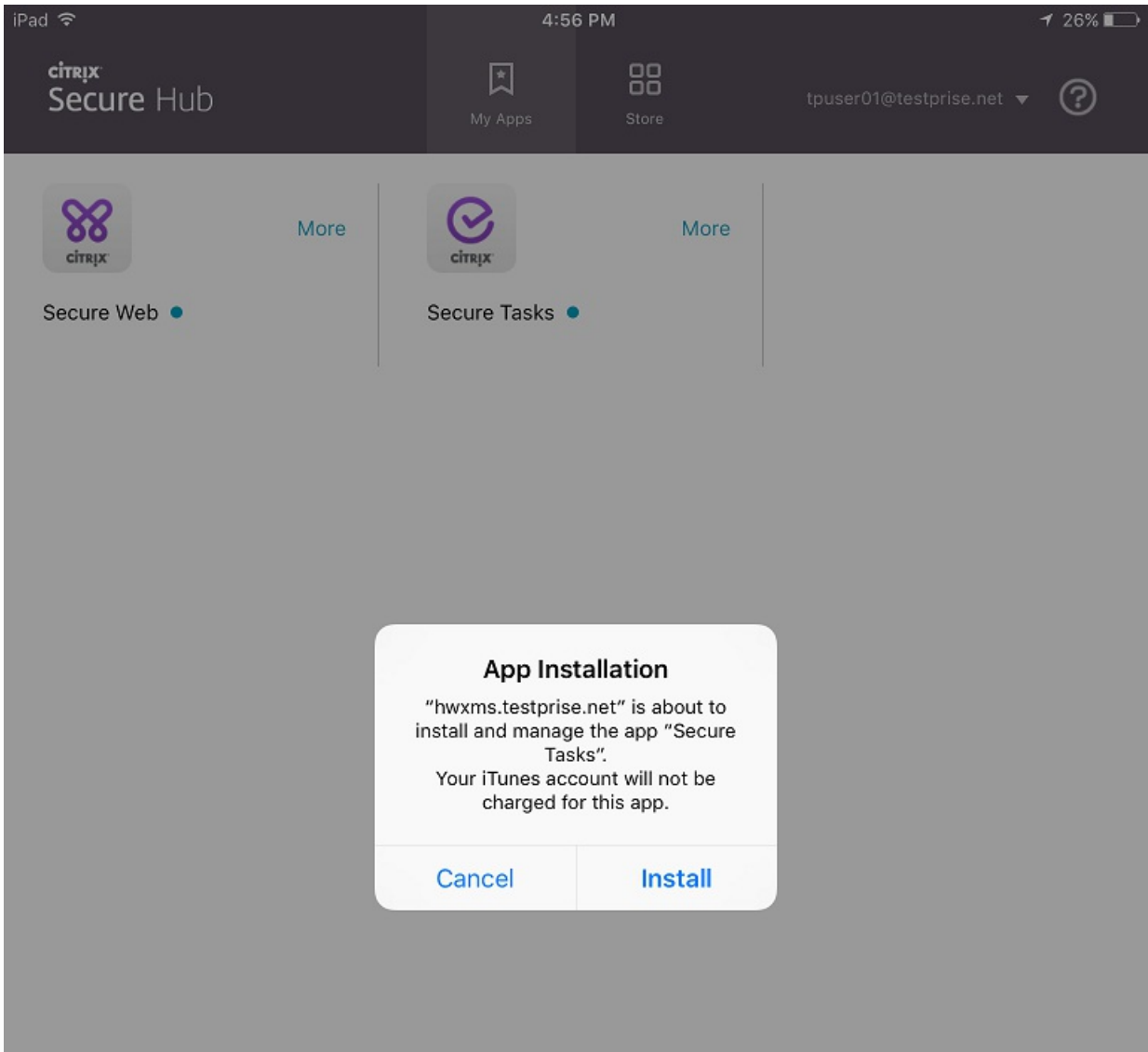

Enterprise apps upgrade immediately even if you set an App update grace period and the user taps to upgrade the app later.

The following tables describe the administrator and user workflow for required apps. The tables describe the behavior in XenMobile Server versions earlier than version 10.6 as compared to the behavior in version 10.6.

The first table describes the workflow on iOS devices. The second table describes the workflow on Android devices.

iOS required app workflow

iOS required app workflow			
Enterprise apps		Public app store apps	
Earlier versions	As of XenMobile Server 10.6	Earlier versions	As of XenMobile Server 10.6
Deploy XenMobile App during initial enrollment; required app is installed on device.	Same.	Deploy XenMobile App during initial enrollment; required app is installed on device.	Same.
Update the app on the XenMobile console.	Same.	Update the app on the XenMobile console.	Same.
Open the Secure Hub Store on the device; the update icon appears in the store.	Click deploy in the XenMobile console to deploy required apps.	Open the Secure Hub Store on the device; the update icon appears in the store	Click deploy in the XenMobile console to deploy required apps.
The app on the springboard is updated.	The app on the springboard is updated.	The app on the springboard is updated. The upgrade starts automatically. Users are not prompted to update.	The app on the springboard is updated. The upgrade starts automatically. Users are not prompted to update.
Users open the app from the springboard; the app prompts users to upgrade in 7 days.	Users open the app from the springboard. Users are prompted to upgrade in 7 days. Actually, the app is upgraded even when users click Later.	Open the app on the device; the app is upgraded. Users are not prompted after a grace period.	Same.
Users click Later; the upgrade is not started. Users click Update now; the upgrade starts.	The app is upgraded.	Users click Later; the upgrade is not started. Users click Update now; the upgrade starts.	The app is upgraded.

Android required app workflow

Enterprise apps		Public app store apps	
Earlier versions	As of XenMobile Server 10.6	Earlier versions	As of XenMobile Server 10.6
Deploy XenMobile App during initial enrollment; required app is installed on device.	Same.	Same.	Same.
Update the app on the XenMobile console	Click deploy in the XenMobile console to deploy required apps.	Update the app on the XenMobile console	Update the app on the XenMobile console
Open the Secure Hub Store on the device; the update icon appears in the store.	The app is upgraded. (Nexus devices prompt for install updates, but Samsung devices do a silent install.)	Open the Secure Hub Store on the device; the update icon appears in the store.	Click Deploy or enter the Secure Hub Store on the device. The update icon appears in the store.
No prompt or update appears on the device springboard.	Users open the app from the springboard. Users are prompted to upgrade in 7 days. In actuality, the app is upgraded even when users click Later .	Users must manually click the update icon in the Secure Hub Store to upgrade. (Nexus prompts users to install updates.)	App upgrade starts automatically. (Nexus devices prompt users to install the update.)
Users open the app from the springboard; the app prompts users to upgrade in 7 days.	App is upgraded.	Open the app on the springboard; the app is upgraded. Users are not prompted for a grace period.	Open the app on the springboard; the app is upgraded. Users are not prompted for a grace period.
Users click Later ; the upgrade does not start. Users click Update now . The upgrade starts. (Users are not prompted to install on Samsung devices, but Nexus prompts for an update.)	The app is upgraded. (Samsung devices do a silent install.)	Users click Later ; the upgrade does not start. Users click Update now . The upgrade starts.	The app is upgraded. (Samsung devices do a silent install.)

Configure an on-premises NetScaler Gateway for use with XenMobile Server

Starting with XenMobile 10.6, you configure NetScaler Gateway for use with XenMobile Server by exporting a script from XenMobile that you run on NetScaler Gateway. The script configures these NetScaler Gateway settings required by XenMobile:

- NetScaler Gateway virtual servers needed for MDM and MAM
- Session policies for the NetScaler Gateway virtual servers
- XenMobile Server details
- Authentication Policies and Actions for the NSG virtual server.

The script describes the LDAP configuration settings.

- Traffic actions and policies for the proxy server
- Clientless access profile
- Static local DNS record on NetScaler
- Other bindings: Service policy, CA certificate

The script doesn't handle the following configuration:

- Exchange load balancing
- ShareFile load balancing
- ICA Proxy configuration
- SSL Offload

If a NetScaler Gateway instance exists, the **Settings > NetScaler Gateway** page now has an **Export Configuration Script** button.

The screenshot shows the XenMobile interface with the following elements:

- Header: XenMobile | Analyze | Manage | Configure | administrator
- Breadcrumbs: Settings > NetScaler Gateway
- Section: **NetScaler Gateway**
- Description: When you configure NetScaler Gateway, you configure the authentication mechanism for remote device access to the internal network. If you use NetScaler Gateway with StoreFront as the authentication server, you need to enable StoreFront as well.
- Authentication: ON
- Deliver user certificate for authentication: ON ⓘ
- Credential provider: Select an option (dropdown)
- Buttons: Save, Add, Edit, Export Configuration Script
- Table:

<input type="checkbox"/>	Name	Default	External URL	Logon Type	# of Callback URLs
<input checked="" type="checkbox"/>	testNS	<input checked="" type="checkbox"/>	https://testns.domain.com	Domain	0

Showing 1 - 1 of 1 items

The **Add New NetScaler Gateway** page also includes a link to export the configuration script.

Settings > NetScaler Gateway > Add New NetScaler Gateway

Add New NetScaler Gateway

Name*	<input type="text" value="Appliance name"/>
Alias	<input type="text"/>
External URL*	<input type="text" value="Publicly accessible URL"/>
Logon Type	<input type="text" value="Domain only"/>
Password Required	<input checked="" type="checkbox"/>
Set as Default	<input type="checkbox"/>
<input type="button" value="Export Configuration Script"/> ⓘ	
Callback URL*	<input type="text"/>
Virtual IP*	<input type="text"/>
<input type="button" value="Add"/>	

For more information, see [NetScaler Gateway and XenMobile](#).

Derived credentials for iOS device enrollment

Derived credentials provide strong authentication for mobile devices. The credentials, derived from a smart card, reside in a mobile device instead of the card. The smart card is either a Personal Identity Verification (PIV) card or Common Access Card (CAC).

The derived credentials are an enrollment certificate that contains the user identifier, such as UPN. XenMobile stores the credentials obtained from the credential provider in a secure vault on the device.

XenMobile can use derived credentials for iOS device enrollment. If configured for derived credentials, XenMobile doesn't support enrollment invitations or other enrollment modes for iOS devices. However, you can use the same XenMobile Server to enroll Android devices through enrollment invitations and other enrollment modes.

Configure derived credentials by using the **Settings > Derived Credentials for iOS** page. By default, the XenMobile console doesn't include **Settings > Derived Credentials**. To enable the interface for derived credentials, go to **Settings > Server Properties**, add the server property **derived.credentials.enable**, and set it to **true**.

XenMobile Analyze Manage Configure administrator

Settings > Derived Credentials for iOS

Derived Credentials for iOS

Configure a derived credentials provider to enable iOS users to enroll with a smart card.

Provider

Choose derived credentials provider* Intercede Other (tech preview)

App URL (iOS)* ⓘ

Optional parameters ⓘ

Name*	Value*	Add

Details

Issuer CA* Import ⓘ

CA Info
Name: dc-demo-WIN-V7749C6OETD-CA
Expire: 2022-01-26

User Identifier field* Subject name ⓘ Subject alternative name

User identifier type* ⓘ

OCSP

OCSP Check OFF ⓘ

For more information, see [Derived credentials for iOS](#). For information about the REST API for derived credentials, see the [XenMobile REST API Reference PDF](#).

Select multiple device platforms for enrollment invitations

You can now select any combination of iOS, macOS, and Android device platforms for an enrollment invitation. The **Manage > Enrollment Invitations** page includes a **Select a platform** setting. The platforms selected determine the **Enrollment mode** options shown and whether some settings, such as **Device info**, appear.

If **Recipient** is **Group**, all platforms are selected by default.

XenMobile Analyze Manage Configure administrator

Devices Users Enrollment Invitations

Add Invitation

1 Enrollment Invitation

Enrollment Invitation

Recipient* Group

Select a platform* Android
 iOS
 macOS

Device ownership Select an ownership type

Domain* Select a domain

Group* Select a group

Enrollment mode* User name + Password

Template for agent download Select a template

Template for enrollment URL Select a template

Template for enrollment confirmation Select a template

Expire after Never

Maximum Attempts 0

Send invitation OFF

If **Recipient** is **User**, no platforms are selected by default.

XenMobile Analyze Manage Configure administrator

Devices Users Enrollment Invitations

Add Invitation

1 Enrollment Invitation

Enrollment Invitation

Recipient* User

Select a platform* Android
 iOS
 macOS

Device ownership Select an ownership type

User name* ⓘ

Enrollment mode* User name + Password

Template for agent download Select a template

Template for enrollment URL Select a template

Template for enrollment confirmation Select a template

Expire after Never

Maximum Attempts 0

Send invitation OFF

Only the **Enrollment mode** options that are valid for each of the selected platforms appear. For example, if all platforms are selected, the valid enrollment modes for that combination are User name + Password, Two Factor, and User name + PIN.

The screenshot shows the 'Add Invitation' form in the XenMobile interface. The 'Enrollment Invitation' section is highlighted. The 'Recipient*' field is set to 'Group'. The 'Select a platform*' field has three checked options: 'Android', 'iOS', and 'macOS'. The 'Device ownership' field is set to 'Select an ownership type'. The 'Domain*' field is set to 'Select a domain'. The 'Group*' field is set to 'Select a group'. The 'Enrollment mode*' field is set to 'User name + Password'. The 'Template for agent download' and 'Template for enrollment URL' fields are also visible, with the 'User name + PIN' option selected in the dropdown menu.

More enrollment options for macOS devices

In addition to enrolling macOS users by sending an enrollment link, you can now enroll macOS users by sending an enrollment invitation. Both methods enable macOS users to enroll over the air, directly from their devices.

An enrollment invitation can use any of the following enrollment modes for macOS devices:

- User name + PIN
- User name + password
- Two Factor

When the user follows the instructions in the enrollment invitation, a sign-on screen with the user name filled in appears.

To send macOS device users an enrollment invitation:

1. Add an invitation for macOS user enrollment. For more information, see [Send users an enrollment invitation](#).

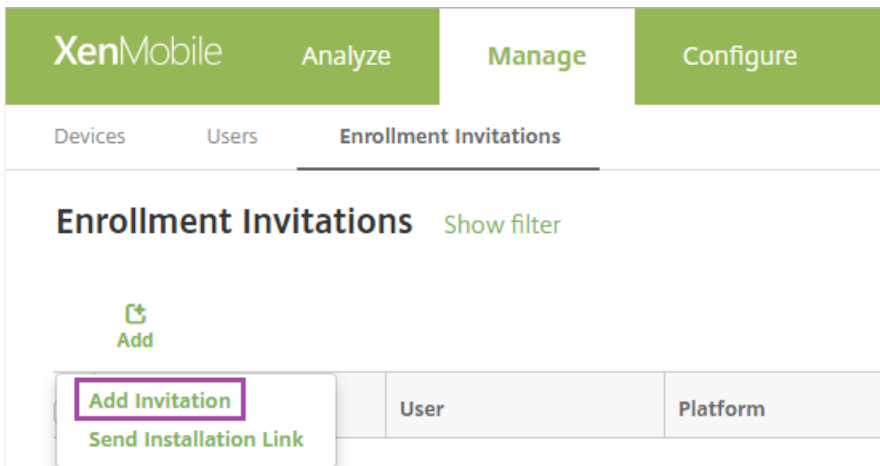

2. After users receive the invitation and click the link, the following screen appears in the Safari browser. XenMobile fills in the user name. If you chose **Two Factor** for the enrollment mode, an extra field appears.

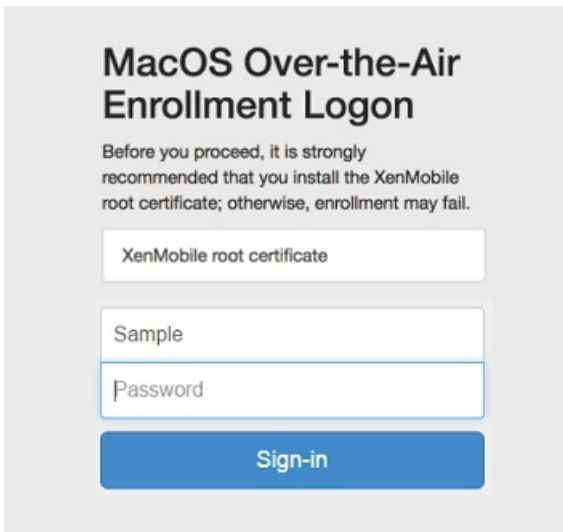

3. Users install certificates as necessary. If you configured a publicly trusted SSL certificate and a publicly trusted digital signing certificate for macOS, XenMobile doesn't prompt users to install a certificate. For more information about certificates, see [Certificates and Authentication](#).
4. Users provide the requested credentials.

You can now start managing Macs with XenMobile just as you manage mobile devices.

To prevent enrollment with an installation link on macOS devices:

You can prevent the use of an enrollment link for macOS devices by setting new server property, **Enable macOS OTAE** (**macos.otae.enable**), to **false**. As a result, macOS users can enroll only by using an enrollment invitation.

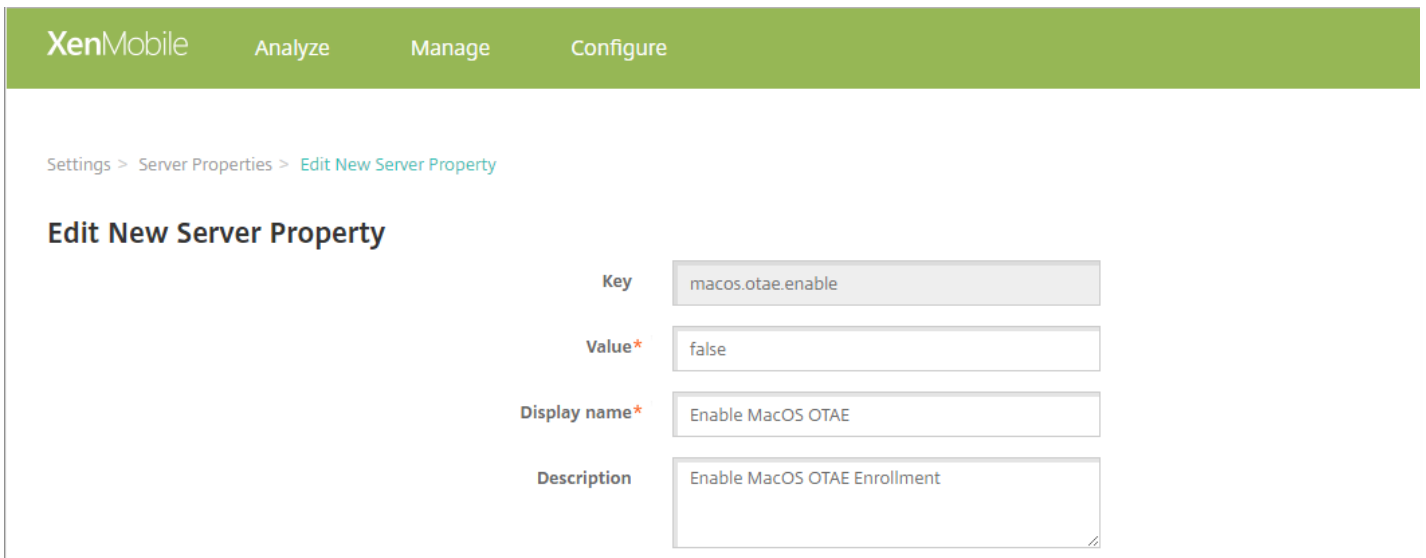

Windows Information Protection device policy

Windows Information Protection (WIP), previously known as enterprise data protection (EDP), is a Windows 10 technology that protects against the potential leakage of enterprise data. Data leakage can occur through sharing of enterprise data to non-enterprise protected apps, between apps, or outside of the network of your organization. For more information, see [Protect your enterprise data using Windows Information Protection \(WIP\)](#) on Microsoft TechNet.

You can create a device policy in XenMobile to specify the apps that require Windows Information Protection at the enforcement level you set. The policy, Windows Information Protection, is for Windows 10 version 1607 and later supervised Phone, Tablet, and Desktop.

You specify an enforcement level that affects the user experience. For example, you can:

- Block any inappropriate data sharing.
- Warn about inappropriate data sharing and allow users to override the policy.
- Run WIP silently while logging and permitting inappropriate data sharing.

To create the policy, go to **Configure > Device Policies** and add the **Windows Information Protection** policy.

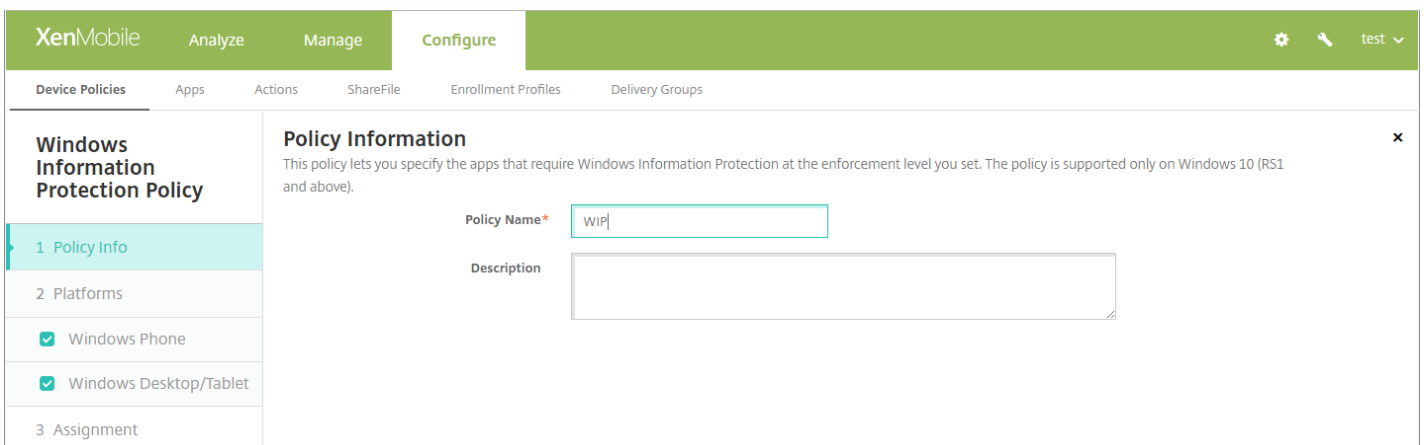

XenMobile Analyze Manage **Configure** Settings Help ttt

Device Policies Apps Actions ShareFile Enrollment Profiles Delivery Groups

Windows Information Protection Policy

This policy lets you specify the apps that require Windows Information Protection at the enforcement level you set. The policy is supported only on Windows 10 (RS1 and above).

Desktop App

File name*	Publisher*	Product name*	Version*	Allowed	Add
ieexplore.exe	O=Microsoft Corporation, L=Redmond, S=Washington, C=US	*	*	Allowed	
notepad.exe	O=Microsoft Corporation, L=Redmond, S=Washington, C=US	*	*	Allowed	
onedrive.exe	O=Microsoft Corporation, L=Redmond, S=Washington, C=US	*	*	Allowed	
*	O=Microsoft Corporation, L=Redmond, S=Washington, C=US	Microsoft Office 2016	*	Allowed	

Store App

Publisher*	Product name*	Version*	Allowed	Add
CN=Microsoft Corporation, O=Microsoft Corporation, L=Redmond, S=Washington, C=US	Microsoft.MicrosoftEdge	*	Allowed	
CN=Microsoft Corporation, O=Microsoft Corporation, L=Redmond, S=Washington, C=US	Microsoft.Office.Word	*	Allowed	
CN=Microsoft Corporation, O=Microsoft Corporation, L=Redmond, S=Washington, C=US	Microsoft.Office.Excel	*	Allowed	
CN=Microsoft Corporation, O=Microsoft Corporation, L=Redmond, S=Washington, C=US	Microsoft.Office.PowerPoint	*	Allowed	
CN=Microsoft Corporation, O=Microsoft Corporation, L=Redmond, S=Washington, C=US	Microsoft.Office.OneNote	*	Allowed	
CN=Microsoft Corporation, O=Microsoft Corporation, L=Redmond, S=Washington, C=US	microsoft.windowscommunicationsapps	*	Allowed	
CN=AA827FA5-A4F1-46AD-BB20-8A79D9C08518	D50536CD.ShareFile	*	Allowed	
CN=Microsoft Corporation, O=Microsoft Corporation, L=Redmond, S=Washington, C=US	microsoft.microsoftskydrive	*	Exempt	

AppLocker policy file:

XenMobile Analyze Manage **Configure** Settings Help test

Device Policies Apps Actions ShareFile Enrollment Profiles Delivery Groups

Windows Information Protection Policy

1 Policy Info

2 Platforms

Windows Phone

Windows Desktop/Tablet

3 Assignment

Enforcement level: 2-Override

Protected domain names*: test.net

Data recovery certificate*: CN=yingd, Serial=56371

Enterprise Network Description

Network domain names*: test.net

IP range*: 10.0.0.0-10.255.255.255

IP ranges list is authoritative:

Proxy servers:

Internal proxy servers:

Cloud resources: citrix.sharefile.com, |citrixdemo-my.sharepoint.com|outlook

Windows Information Protection Settings

Revoke WIP certificate on unenroll:

Show overlay icons:

The screenshot shows the XenMobile Configure page for a Windows Information Protection Policy. The left sidebar lists '1 Policy Info', '2 Platforms', and '3 Assignment'. Under '2 Platforms', 'Windows Phone' and 'Windows Desktop/Tablet' are checked. The main content area shows the policy details and a table of Store Apps.

Windows Information Protection Policy
 This policy lets you specify the apps that require Windows Information Protection at the enforcement level you set. The policy is supported only on Windows 10 (RS1 and above).

Store App

Publisher*	Product name*	Version*	Allowed	Add
CN=Microsoft Corporation, O=Microsoft Corporation, L=Redmond, S=Washington, C=US	Microsoft.MicrosoftEdge	*	Allowed	
CN=Microsoft Corporation, O=Microsoft Corporation, L=Redmond, S=Washington, C=US	Microsoft.Office.Word	*	Allowed	
CN=Microsoft Corporation, O=Microsoft Corporation, L=Redmond, S=Washington, C=US	Microsoft.Office.Excel	*	Allowed	
CN=Microsoft Corporation, O=Microsoft Corporation, L=Redmond, S=Washington, C=US	Microsoft.Office.PowerPoint	*	Allowed	
CN=Microsoft Corporation, O=Microsoft Corporation, L=Redmond, S=Washington, C=US	Microsoft.Office.OneNote	*	Allowed	
CN=Microsoft Corporation, O=Microsoft Corporation, L=Redmond, S=Washington, C=US	microsoft.windowscommunicationsapps	*	Allowed	
CN=AAB27FA5-A4F1-46AD-BB20-8A79D9C08518	D50536CD.ShareFile	*	Allowed	
CN=Microsoft Corporation, O=Microsoft Corporation, L=Redmond, S=Washington, C=US	microsoft.microsoftskydrive	*	Exempt	

AppLocker policy file:

For more information, see [Windows Information Protection device policy](#).

Citrix VPN connection type for Android devices

The VPN device policy for Android now supports configuring Citrix VPN. Citrix VPN is a mobile application that connects to NetScaler Gateway in full VPN mode, as opposed to a clientless VPN or ICA proxy mode. This feature requires Secure Hub 10.6.

On the **Configure > Device Policies** page for Android, the **Connection type** menu now includes **Citrix VPN**.

The screenshot shows the XenMobile Configure page for a VPN Policy. The left sidebar lists '1 Policy Info', '2 Platforms', and '3 Assignment'. Under '2 Platforms', 'iOS', 'Mac OS X', 'Android', 'Samsung SAFE', 'Samsung KNOX', 'Windows Phone', 'Windows Desktop/Tablet', and 'Amazon' are checked. The main content area shows the policy details and configuration fields.

VPN Policy
 This policy lets you configure a VPN connection to provide a device-level encrypted connection to the intranet. For Windows Phone, the policy is supported only on Windows 10 and later supervised devices.

Connection name* ⓘ

Server name or IP address* ⓘ

Connection type:

Authentication type for the connection:

User name:

Password:

Per-app VPN: Enable per-app VPN

Custom XML
 Custom parameters

Parameter name*	Value	Add
		<input type="button" value="Add"/>

VPN Policy

This policy lets you configure a VPN connection to provide a device-level encrypted connection to the intranet. For Windows Phone, the policy is supported only on Windows 10 and later supervised devices.

Connection name*

Server name or IP address*

Connection type

Authentication type for the connection

User name

Password

Identity credential

Per-app VPN

Enable per-app VPN

Custom XML

Custom parameters

Parameter name*	Value	<input type="button" value="Add"/>

Settings for the Citrix VPN connection type:

- **Server name or IP address:** Type the FQDN or IP address of the NetScaler Gateway.
- **User name and Password:** Type your VPN credentials for the **Authentication types** of **Password** or **Password and Certificate**. Optional. If you don't provide the VPN credentials, the Citrix VPN app prompts for a user name and password.
- **Identity credential:** Appears for the **Authentication types** of **Certificate** or **Password and Certificate**.
- **Enable per-app VPN:** Select whether to enable per-app VPN. If you don't enable per-app VPN, all traffic goes through the Citrix VPN tunnel. If you enable per-app VPN, specify the following settings. The default is **OFF**.
 - **Whitelist or Blacklist:** Choose a setting. If **Whitelist**, all apps in the whitelist tunnel through this VPN. If **Blacklist**, all apps except any on the blacklist tunnel through this VPN.
 - **Application List:** Specify the whitelisted or blacklisted apps. Click **Add** and then type a comma-separated list of app package names.
- **Custom XML:** Click **Add** and then type custom parameters. XenMobile supports these parameters for Citrix VPN:
 - **disableL3Mode:** Optional. To enable this parameter, type **Yes** for the **Value**. If enabled, no user-added VPN connections are displayed and the user cannot add another connection. The restriction is global and applies to all VPN profiles.
 - **userAgent:** A string value. You can specify a custom User Agent string to send in each HTTP request. The specified user agent string is appended to the existing Citrix VPN user agent.

The screenshot shows the XenMobile 'Configure' page for a 'VPN Policy'. The left sidebar lists policy sections: '1 Policy Info', '2 Platforms', and '3 Assignment'. Under '2 Platforms', several operating systems are listed with checkboxes: iOS, Mac OS X, Android (highlighted), Samsung SAFE, Samsung KNOX, Windows Phone, Windows Desktop/Tablet, and Amazon. The main configuration area for the 'VPN Policy' includes the following fields:

- Connection name***: Text input field with a help icon.
- Server name or IP address***: Text input field with a help icon.
- Connection type**: Dropdown menu set to 'Citrix VPN'.
- Authentication type for the connection**: Dropdown menu set to 'Password and Certificate'.
- User name**: Text input field.
- Password**: Text input field.
- Identity credential**: Dropdown menu set to 'None' with a help icon.
- Per-app VPN**: Section containing an 'Enable per-app VPN' toggle switch, currently set to 'OFF'.
- Custom XML**: Section for 'Custom parameters' with a table header:

Parameter name*	Value	Add
+ Add		

For more information, see [VPN device policy](#).

XenMobile integration with Azure Active Directory as IDP

Configuring Azure Active Directory (AD) as your identity provider (IDP) lets users enroll in XenMobile using their Azure credentials.

iOS, Android, and Windows 10 devices are supported. iOS and Android devices enroll through Secure Hub.

You configure Azure as your IDP under **Settings > Authentication > IDP**. The **IDP** page is new to this version of XenMobile. In previous versions of XenMobile, you configured Azure under **Settings > Microsoft Azure**.

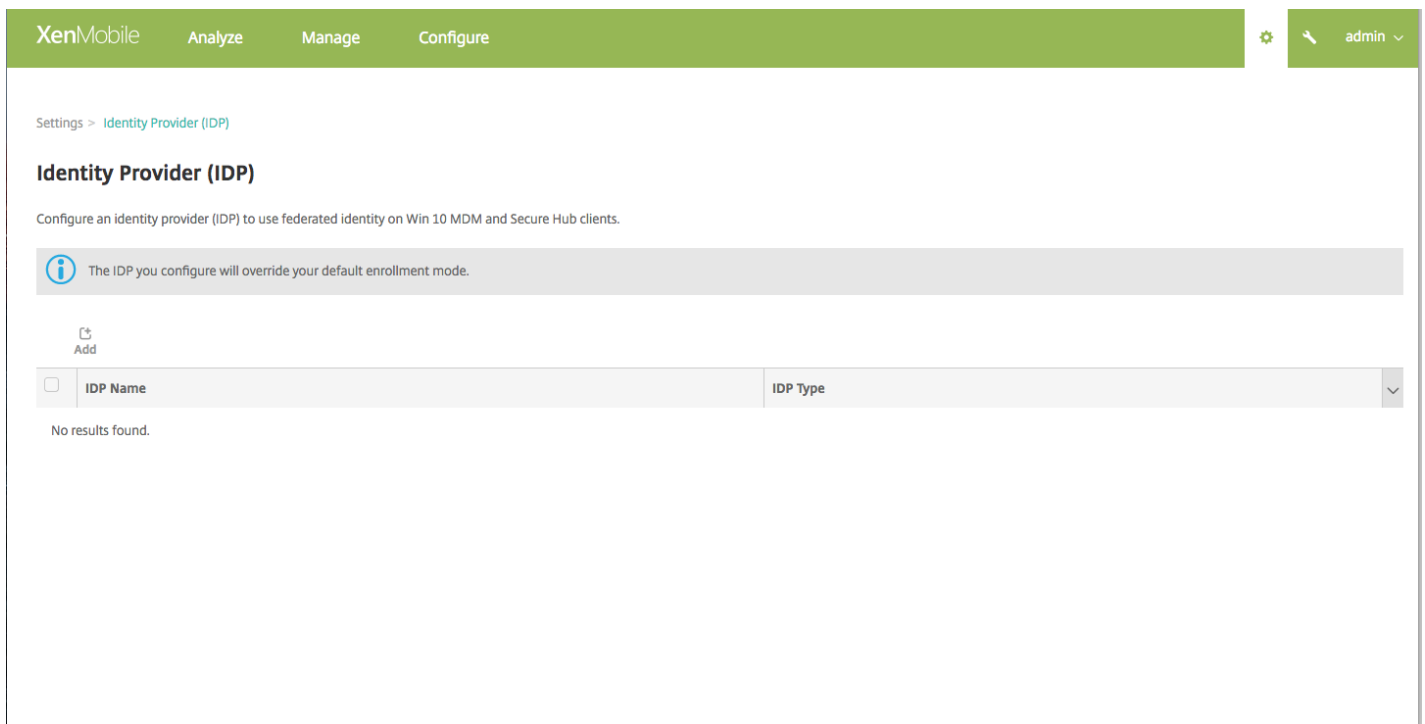

For more information, see [XenMobile integration with Azure Active Directory as IDP](#).

Deploy device policies, apps, and smart actions based on app ID

You can now configure XenMobile to deploy device policies, apps, and smart actions based on app ID. To do that, you use a new deployment rule, **Installed app name**.

You can use this new feature to migrate from enterprise app store distribution to public app store distribution:

- Use the **Installed app name** rule with the App Uninstall device policy. Doing so triggers XenMobile to remove enterprise apps from user devices after the public app store version installs.
- This feature is available only for managed iOS devices connected to a XenMobile Server in enterprise mode (XME).

Note

Citrix requires that you use public app store versions of Citrix apps, instead of Enterprise versions, by the end of 2017.

To configure the App Uninstall device policy for an Enterprise app:

1. In **Configure > Device Policies**, click **Add**, and then click **App Uninstall**.
2. Name the policy and then remove the check boxes for all but the **iOS** platform.
3. On the **iOS** page, choose the app bundle ID for the old Enterprise app and then expand **Deployment Rules**.

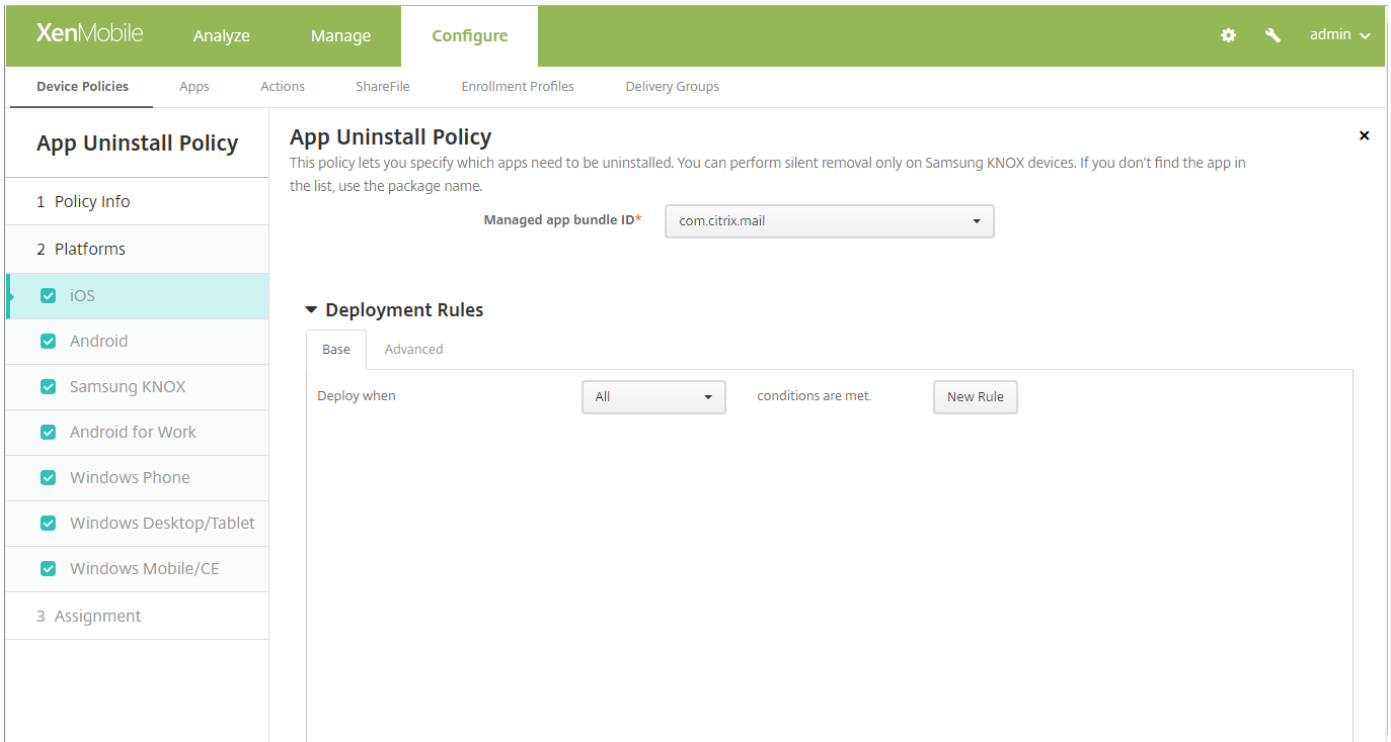

4. Add a rule: Click **New Rule** and then, as shown in the sample, choose **Installed app name** and **is equal to**. Type the app bundle ID for the public app store app.

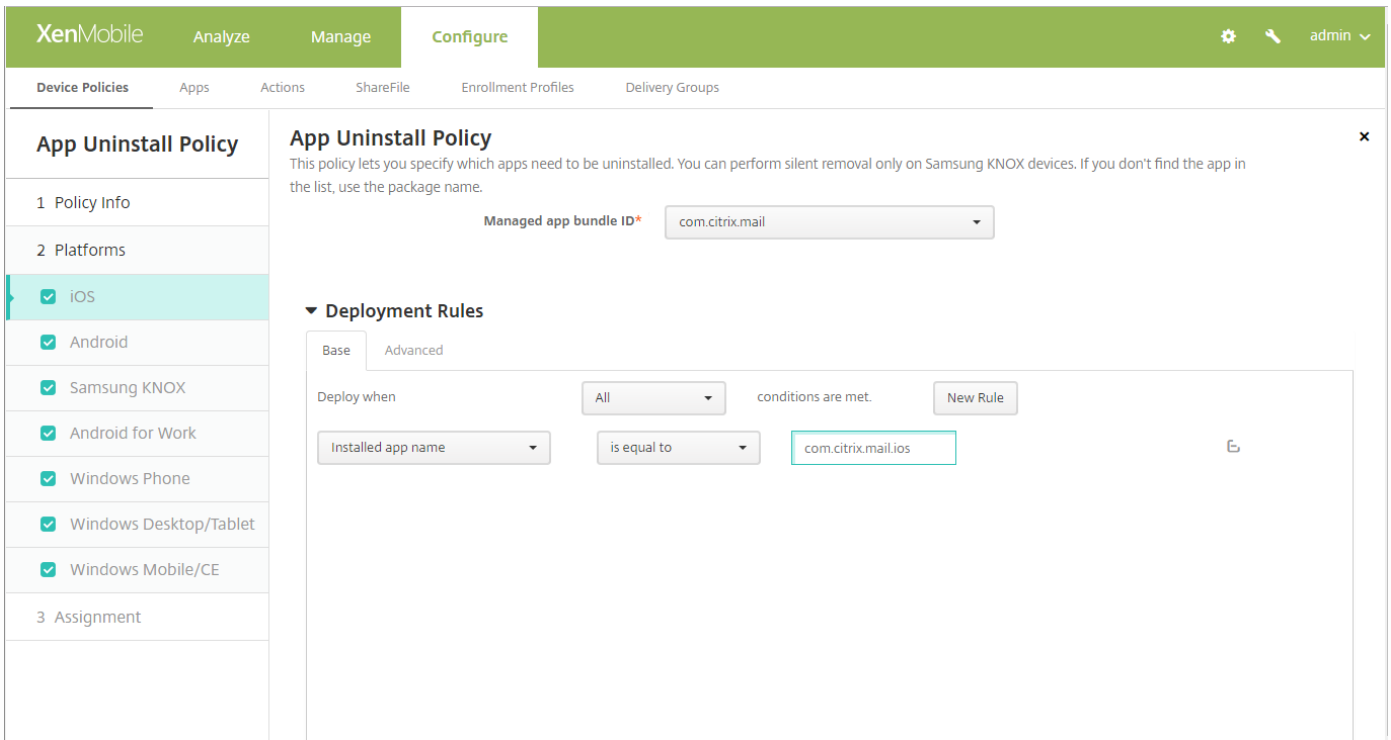

5. Complete the **Assignment** page and then click **Save**.

In the example, after the public app store app (com.citrix.mail.ios) installs on a device in the delivery groups specified,

XenMobile removes the Enterprise version (com.citrix.mail).

Reporting improvements

The XenMobile **Analyze > Reporting** page has an improved design and more features for all pre-defined reports:

- Sorting and searching using device-based filters.
- Filtering reports by date
- Exporting reports in PDF format.
- Interactive charts that represent report data visually.
- The Top 25 Apps report is now called Total Apps Deployment Attempts. This report now lists all deployed apps and the percentage of users that have attempted to install them on their devices.

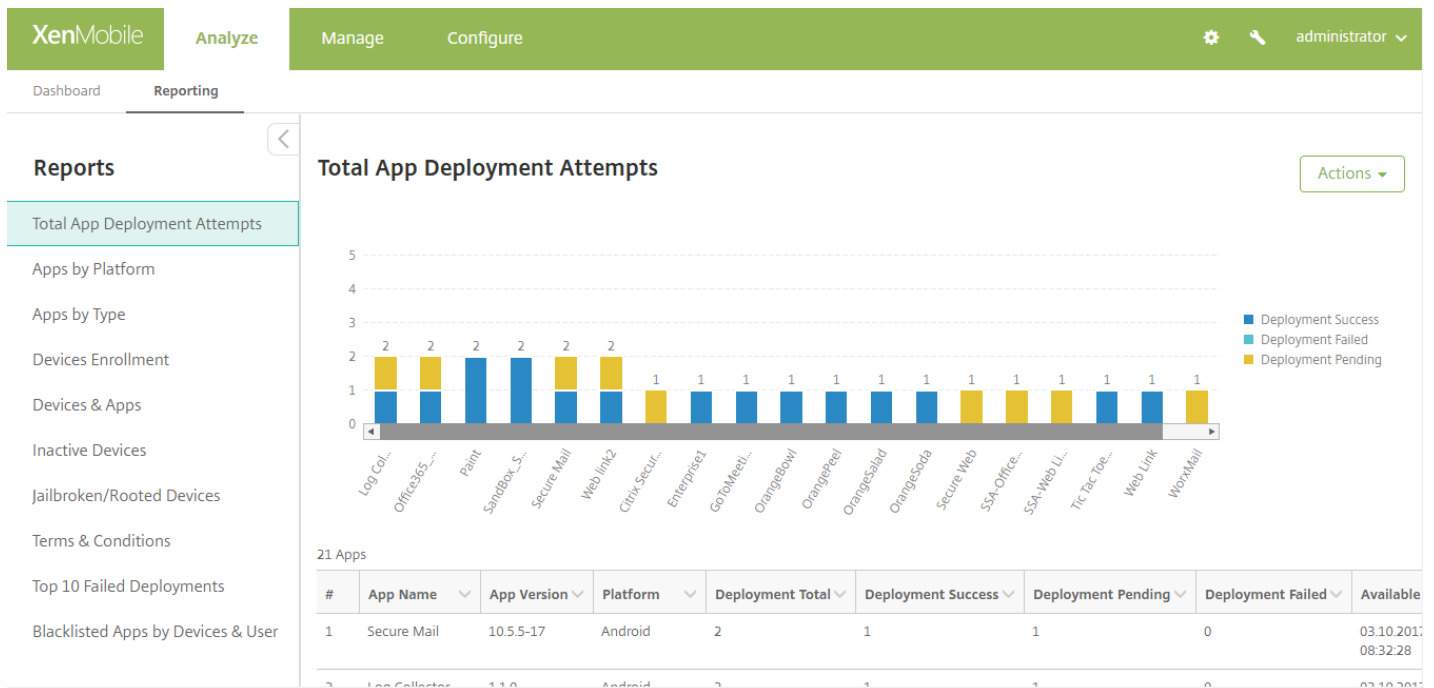

For more information, see [Reports](#).

Locate Windows 10 devices

XenMobile console administrators and Self Help Portal users can now locate Windows 10 phones, desktops, and tablets. The locate feature is already available for iOS and Android devices. When you issue a locate command, the XenMobile Server communicates directly with the device.

From the XenMobile console, send the Locate action to a device as follows.

1. On **Manage > Devices**, select the device, and then click **Secure**.

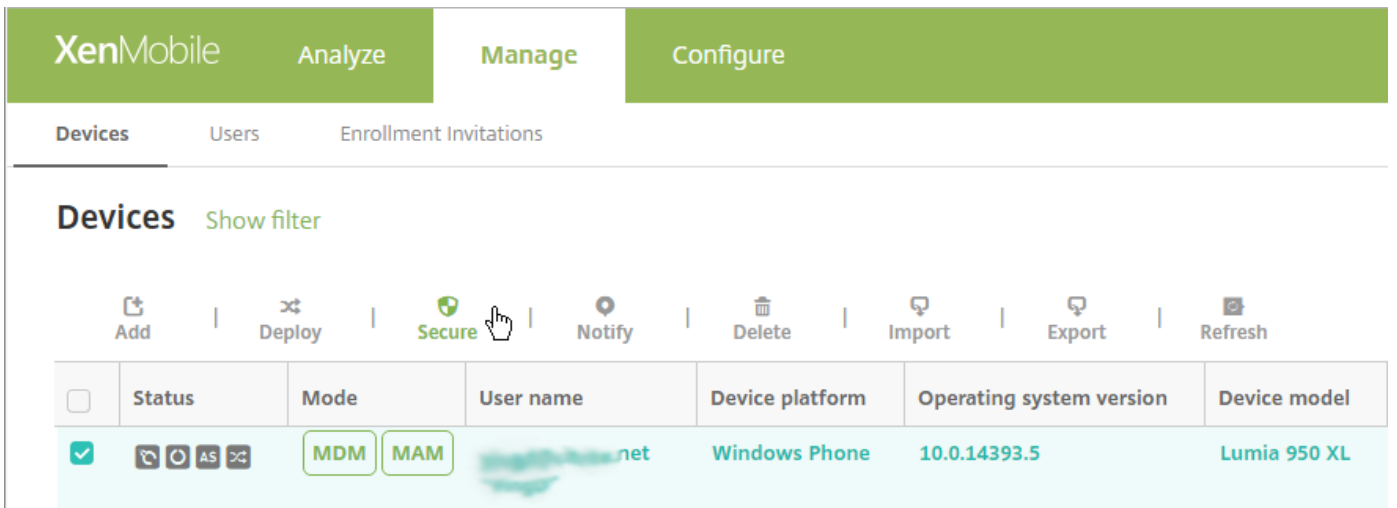

2. In **Security Actions**, click **Locate**.

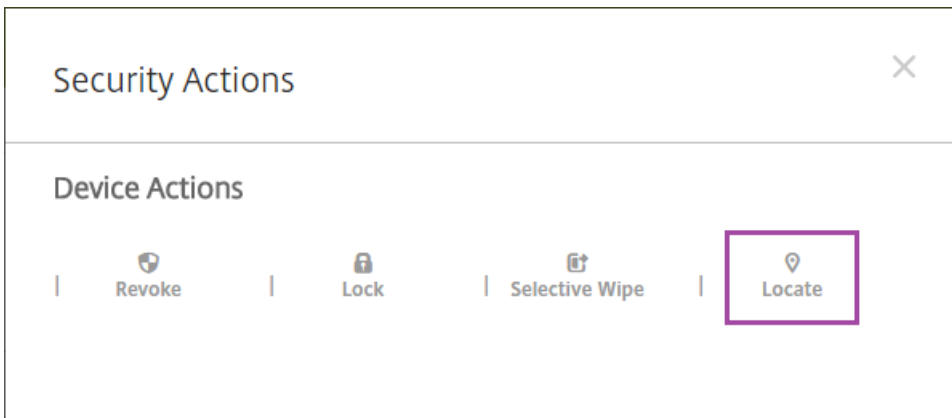

The **Device details** page provides a status of the location request and shows a map if the device is located.

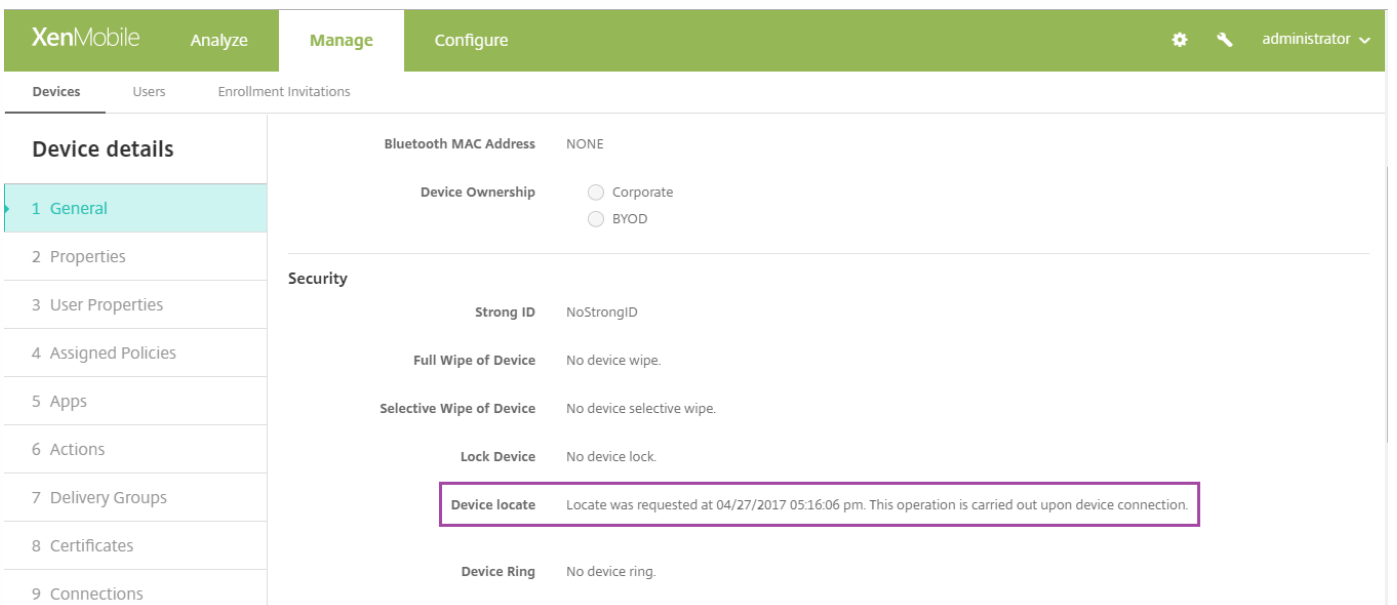

XenMobile Analyze **Manage** Configure administrator

Devices Users Enrollment Invitations

Device details

- 1 General
- 2 Properties
- 3 User Properties
- 4 Assigned Policies
- 5 Apps
- 6 Actions
- 7 Delivery Groups
- 8 Certificates
- 9 Connections

Full Wipe of Device	No device wipe.
Selective Wipe of Device	No device selective wipe.
Lock Device	No device lock.
Device locate	Locate was done at 01/26/2017 05:03:05 pm. Last known location: Locate the device on Google Maps 37.40234, -119.9788
Device Ring	No device ring.

Location

More device status properties for Windows 10 Phone and Tablet

The **Manage > Devices** page includes more device properties for Windows. The following properties, provided by the Windows 10 DeviceStatus configuration service provider (CSP), are available.

- Antispyware Signature Status
- Antispyware Status
- Antivirus Signature Status
- Antivirus Status
- Battery Charging
- Battery Remaining
- Encryption Compliance
- Firewall Status
- IPV4 Address
- IPV6 Address
- MAC Address Network Connection
- MAC Address Type
- Operating System Edition
- Primary SIM Carrier Operator
- Primary SIM ICCID
- Primary SIM Roaming compliance
- Secure Boot status

TPM Version
User Account Control Status

For information about those properties, see the Microsoft article [DeviceStatus CSP](#). The following sample shows a few of the added properties.

The screenshot shows the XenMobile console interface. The top navigation bar includes 'XenMobile', 'Analyze', 'Manage', and 'Configure'. The user is logged in as 'administrator'. The left sidebar shows 'Device details' with a list of sections: 1 General, 2 Properties (selected), 3 User Properties, 4 Assigned Policies, 5 Apps, 6 Actions, 7 Delivery Groups, 8 Certificates, and 9 Connections. The main content area displays the device 'test1' (Lumia 950 XL Dual SIM) with the following properties:

Property	Value
Custom	
Manual Unenrollment	true
Battery	
Battery Charging	No
Battery Remaining	92%
Network information	
Home carrier network	000-US
IMSI	3104
Primary SIM Carrier Operator	T-Mobil
Primary SIM ICCID	89012
Primary SIM Roaming Compliance	Yes

Device policy to control OS updates on iOS devices

You can now configure XenMobile to send the latest OS updates to supervised iOS devices. You choose whether to deploy OS updates to devices so that users can install the updates manually, or to force installation on devices. To configure the new device policy, go to **Configure > Device Policies** and add **Control OS Update**.

The screenshot shows the XenMobile console interface for configuring a device policy. The top navigation bar includes 'XenMobile', 'Analyze', 'Manage', and 'Configure'. The user is logged in as 'administrator'. The left sidebar shows 'Device Policies' with a list of sections: 1 Policy Info, 2 Platforms, 3 Assignment. The 'iOS' platform is selected. The main content area displays the 'Control OS Update' policy configuration:

Control OS Update
This policy lets you push OS updates to user devices and force OS installation on users devices.

OS update options*

- Download Only ⓘ
- Download and/or install ⓘ

OS update frequency (1-365 days)* ⓘ

► **Deployment Rules**

Configure the options:

- **OS update options:** Both of the options download the latest OS updates to supervised devices according to the **OS**

update frequency. The device prompts users to install updates. The prompt is visible after the user unlocks the device.

- **OS update frequency (1–365 days):** Determines how frequently XenMobile checks and updates the device OS. The default is 7 days.

More WiFi policy options for iOS 10+

- **Disable Captive Network Detection:** If **ON**, users can't join networks that require agreements or other information before network access. Default is **OFF**.
- **Fast Lane QoS Marking:** Quality of Service (QoS) marking enables you to prioritize network bandwidth for specific business apps. Choose to restrict or not restrict Cisco Fast Lane QoS marking. If you don't restrict QoS marking for a WiFi network that supports Cisco Fast Lane QoS, all apps are whitelisted to use L2 and L3 marking. If you restrict QoS marking, specify the apps that can use L2 and L3 marking. Default is **Do not restrict QoS marking**.

If **Fast Lane QoS Marking** is **Restrict QoS marking**, the following options appear:

- **Enable QoS Marking:** Optional. If **OFF**, QoS marking is disabled. Default is **ON**.
- **Whitelist Apple audio/video calling:** Optional. If **OFF**, Apple audio and video calling aren't whitelisted, which means the traffic isn't prioritized. Default is **ON**.
- **Whitelist specific apps:** Specify the apps to use L2 and L3 marking.

For more information about WiFi policies for iOS, see [Apple Configurator 2 Help](#).

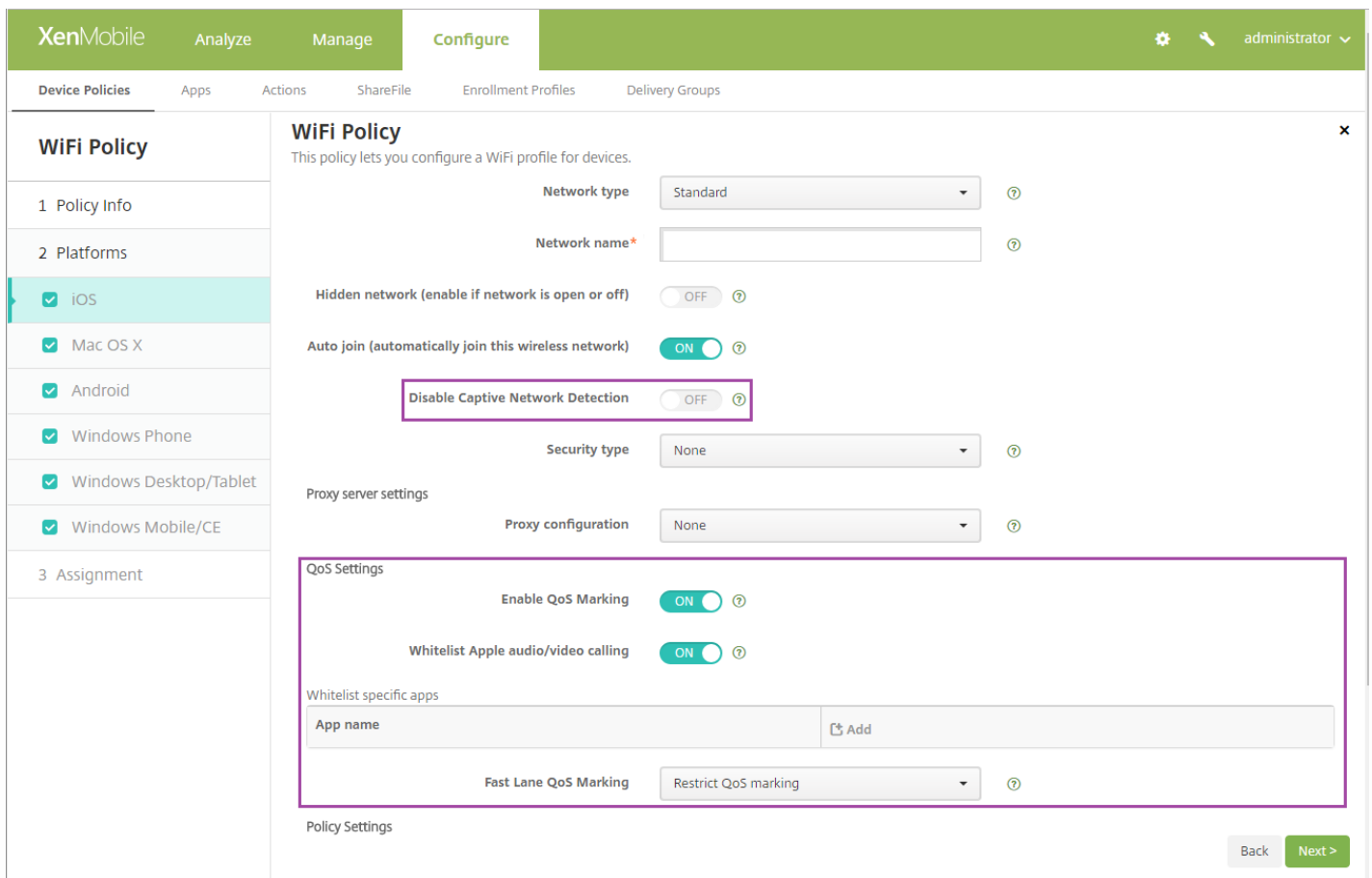

More per-app VPN policy options for iOS

The VPN policy includes these new options, which are used when the VPN client on a device supports multiple VPN providers:

- **Provider bundle identifier:** If the app specified in **Custom SSL identifier** has multiple VPN providers of the same type (App proxy or Packet tunnel), then specify this bundle identifier.
- **Provider type:** A provider type indicates whether the provider is a VPN service or proxy service. For VPN service, choose **Packet tunnel**. For proxy service, choose **App proxy**. This option is visible when **Enable per-app VPN** is **ON**.

Per-app VPN options are available for these connection types: Cisco AnyConnect, Juniper SSL, F5 SSL, SonicWALL Mobile Connect, Ariba VIA, Citrix VPN, and Custom SSL.

To configure a per-app VPN:

1. In **Configure > Device Policies**, create a VPN policy. For example:

XenMobile Analyze Manage **Configure** administrator

Device Policies Apps Actions ShareFile Enrollment Profiles Delivery Groups

VPN Policy

This policy lets you configure a VPN connection to provide a device-level encrypted connection to the intranet. For Windows Phone, the policy is supported only on Windows 10 and later supervised devices.

1 Policy Info

2 Platforms

- iOS
- Mac OS X
- Android
- Samsung SAFE
- Samsung KNOX
- Windows Phone
- Windows Desktop/Tablet
- Amazon

3 Assignment

Connection name XenMobile

Connection type Custom SSL

Custom SSL identifier (reverse DNS format)* com.xenmobile

Provider bundle identifier com.xenmobile.xenmobile.NE

Server name or IP address* app-domain.com

User account Suser.username

Authentication type for the connection Password

Auth Password

Per-app VPN

Enable per-app VPN ON iOS 7.0+

On-demand match app enabled ON

Provider type Packet tunnel

Safari domains

Domain* Add

XenMobile Analyze Manage **Configure** administrator

Device Policies Apps Actions ShareFile Enrollment Profiles Delivery Groups

VPN Policy

1 Policy Info

2 Platforms

- iOS
- Mac OS X
- Android
- Samsung SAFE
- Samsung KNOX
- Windows Phone
- Windows Desktop/Tablet

Custom XML

Custom parameters

Parameter name*	Value	Add

Proxy

Proxy configuration None

Policy Settings

Remove policy Select date Duration until removal (in hours)

Allow user to remove policy Always

Deployment Rules

Back Next >

- In **Configure > Device Policies**, create an App Attributes policy to associate an app to the per-app VPN policy. For **Per-app VPN identifier**, choose the name of the VPN policy created in Step 1. For **Managed app bundle ID**, choose from the app list or enter the app bundle ID. (If you deploy an iOS App Inventory policy, the apps list contains apps.)

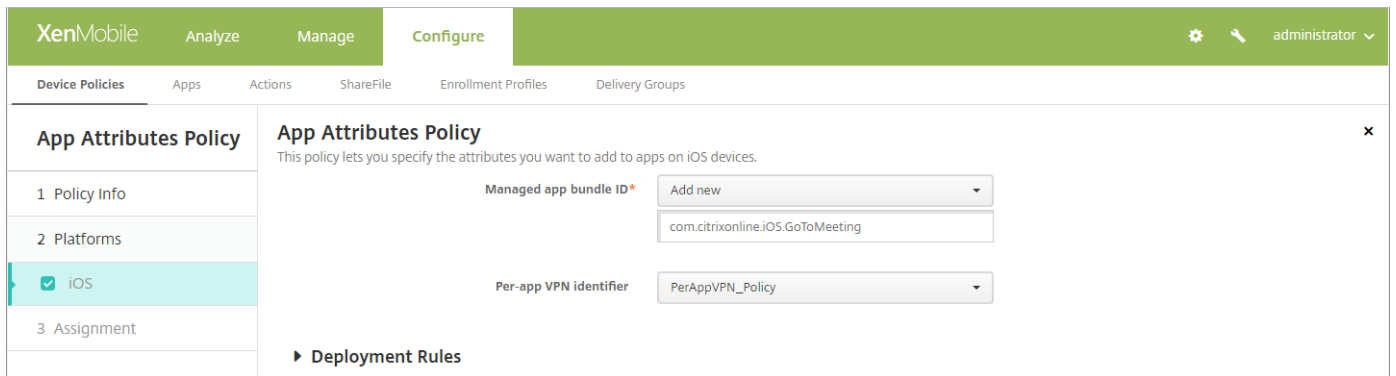

More feature restriction options for macOS devices

The Restrictions device policy has the following extra restriction options for macOS. By default, XenMobile allows all these features.

For macOS 10.12.4 and later:

- Allow Touch ID To Unlock Mac
- Allow iCloud Desktop and Documents

For macOS 10.12 and later:

- Allow iCloud Photos
If you change this setting to **Off**, any photos not fully downloaded from the iCloud Photo Library are removed from local device storage.
- Allow Auto Unlock
For information about this option and Apple Watch, see <https://support.apple.com/en-ie/HT206995>.

The screenshot shows the XenMobile Configure interface. On the left, the 'Restrictions Policy' sidebar is visible, with 'Mac OS X' selected under the '2 Platforms' section. The main area displays various settings for Mac OS X, each with a toggle switch and a version requirement. The following table summarizes the visible settings:

Setting Name	Toggle State	Version Requirement
Allow Spotlight Suggestions	ON	
Allow Look Up	OFF	OS X 10.11.2+
Allow use of iCloud password for local accounts	ON	
Allow iCloud documents & data	ON	
Allow iCloud Desktop and Documents	Checked	macOS 10.12.4+
Allow iCloud Keychain Sync	ON	macOS 10.12+
Allow iCloud Mail	ON	macOS 10.12+
Allow iCloud Contacts	ON	macOS 10.12+
Allow iCloud Calendars	ON	macOS 10.12+
Allow iCloud Reminders	ON	macOS 10.12+
Allow iCloud Bookmarks	ON	macOS 10.12+
Allow iCloud Notes	ON	macOS 10.12+
Allow iCloud Photos	ON	macOS 10.12+
Allow Auto Unlock	ON	macOS 10.12+
Allow Touch ID To Unlock Mac	ON	macOS 10.12.4+

More IKEv2 parameters for the VPN device policy

iOS 10.0

The IKEv2, AlwaysOn IKEv2, and AlwaysOn IKEv2 Dual Configuration connection types have more parameters for iOS 10.0.

The screenshot shows the 'Configure' page for a VPN Policy in XenMobile. The left sidebar lists 'VPN Policy' with sub-sections '1 Policy Info', '2 Platforms', and '3 Assignment'. Under '2 Platforms', 'iOS' is selected. The main content area is titled 'VPN Policy' and includes the following settings:

- Enable Perfect Forward Security:** A toggle switch set to 'OFF' for 'iOS 9.0+'.
- DNS server IP addresses:** A table with two rows: 'dn1.vpn.net' and 'dns2.vpn.net'. Each row has an 'Add' button.
- Domain name:** A text input field containing 'domainN' for 'iOS 10.0+'.
- Search Domains:** A table with one row: 'SDomain1'. It has an 'Add' button and a delete icon.
- Append supplemental match domains to resolver's list:** A toggle switch set to 'ON' for 'iOS 10.0+'.
- Supplemental Match Domains:** A table with one row: 'SupMatchDomain'. It has an 'Add' button.
- IKE SA Parameters:** A section header at the bottom.

DNS server IP addresses: Optional. A list of DNS server IP addresses. These IP addresses can include a mixture of IPv4 and IPv6 addresses.

Domain name: Optional. The primary domain of the tunnel.

Search domains: Optional. A list of domains used to qualify single-label host names fully.

Append supplemental match domains to resolver's list: Optional. Determines whether to append the domains in Supplemental match domains to the Search domains for the resolver. **0** means append; **1** means don't append. Default is **0**.

Supplemental match domains: Optional. A list of domains used to determine which DNS queries are to use the DNS resolver settings contained in the DNS server addresses. This key creates a split DNS configuration where only hosts in certain domains get resolved by using the DNS resolver of the tunnel. Hosts not in one of the domains in this list get resolved by using the default resolver of the system.

If you save an empty string for this parameter, XenMobile uses that string as the default domain. This solution is how a split-tunnel configuration can direct all DNS queries first to the VPN DNS servers before the primary DNS servers. If the VPN tunnel becomes the default route of the network, the listed DNS servers become the default resolver. In that case, the supplemental match domains list is ignored.

iOS 9.0

The IKEv2, AlwaysOn IKEv2, and AlwaysOn IKEv2 Dual Configuration connection types have more parameters for iOS 9.0.

These parameters apply to all three IKEv2 connection types:

- **Disable Mobility and Multihoming**
- **Use IPv4/IPv6 internal subnet attributes**
- **Disable redirects**
- **Enable Perfect Forward Secrecy**

The two AlwaysOn IKEv2 connection types also include:

- **Enable NAT keepalive while the device is asleep**

Keepalive packets maintain NAT mappings for IKEv2 connections. The chip sends these packets at regular interval when the device is awake. If this setting is **on**, the chip sends keepalive packets even while the device is asleep.

The default interval is 20 seconds over WiFi and 110 seconds over cellular. You can change the interval by using the **NAT keepalive interval** parameter.

- **NAT keepalive interval (seconds)**

Defaults to **20** seconds.

Support for Zebra rugged Android-based mobile devices

XenMobile now supports users with Zebra Android devices.

Important: Zebra devices must install Secure Hub 10.5.10 to enroll in XenMobile.

In the XenMobile console, when you manage a Zebra device, several properties appear in **Manage > Devices**, in the **Device details, Properties** list.

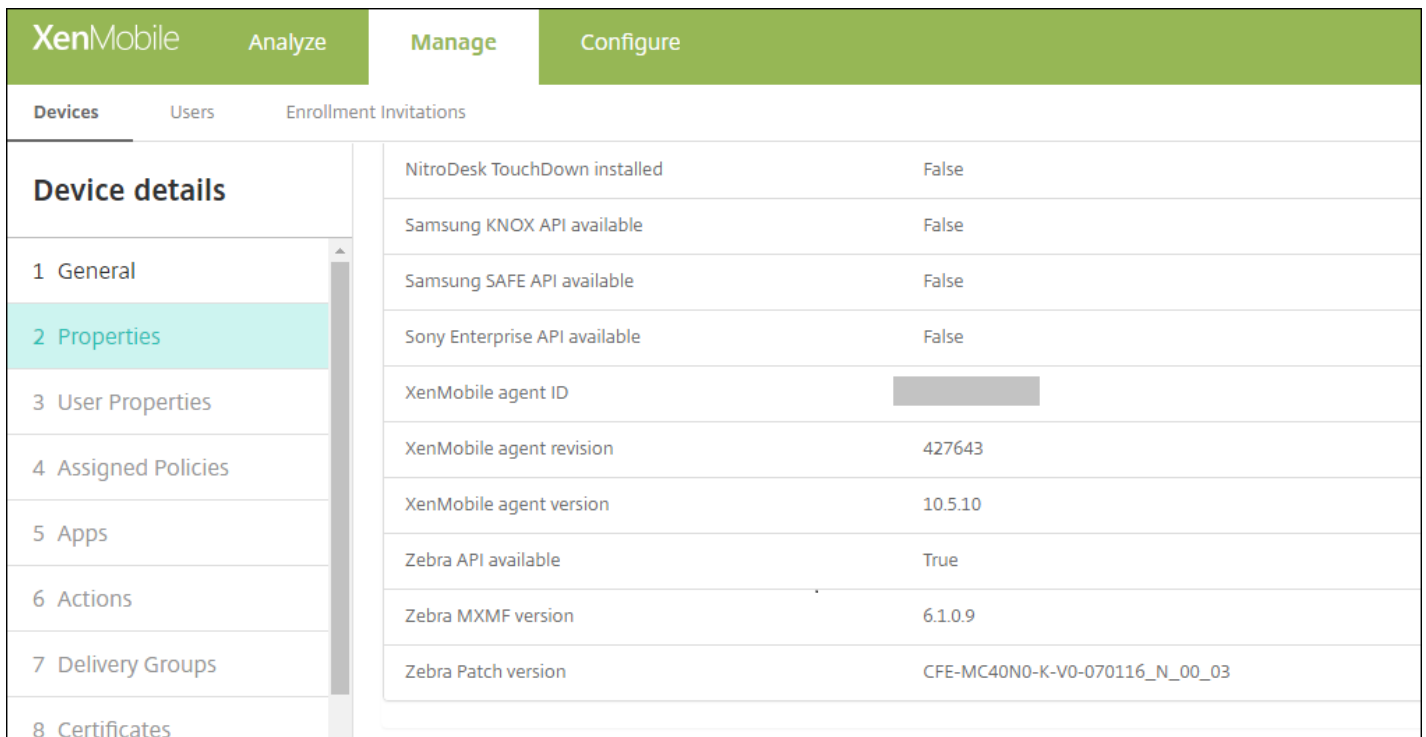

XenMobile		
Analyze	Manage	Configure
Devices	Users	Enrollment Invitations
Device details		
1 General	NitroDesk TouchDown installed	False
2 Properties	Samsung KNOX API available	False
3 User Properties	Samsung SAFE API available	False
4 Assigned Policies	Sony Enterprise API available	False
5 Apps	XenMobile agent ID	[REDACTED]
6 Actions	XenMobile agent revision	427643
7 Delivery Groups	XenMobile agent version	10.5.10
8 Certificates	Zebra API available	True
	Zebra MXMF version	6.1.0.9
	Zebra Patch version	CFE-MC40N0-K-V0-070116_N_00_03

- **Zebra API:** Indicates that the device contains the Zebra API.
- **Zebra MXMF version:** Indicates the MX Management Framework (MXMF) available for exposing APIs and configuring and managing Zebra Android-based devices.
- **Zebra patch version:** Indicates the patch version currently installed on the device.

For more details about Zebra devices, see the Zebra Technologies documentation.

The **Custom XML** MDM policy is also available for the Zebra platform.

The screenshot shows the XenMobile interface with the 'Configure' tab selected. Under 'Device Policies', the 'Custom XML Policy' configuration page is open. The left sidebar shows a navigation menu with '1 Policy Info' selected. The main content area is titled 'Policy Information' and includes a sub-header: 'This policy lets you create custom XML for your policies. After you enter the XML, you can check the syntax.' Below this, there are two input fields: 'Policy Name*' with the value 'Zebra Custom XML-1' and 'Description' with the value 'Zebra Custom XML 1 (10.5.1.4)'. The left sidebar also lists platform options: Windows Phone, Windows Desktop/Tablet, Windows Mobile/CE, Zebra (checked), and Assignment.

Other improvements

- **Exchange policy now available for Windows 10 for Tablet.** To add the policy, go to **Configure > Device Policies**. The settings are the same as for Windows 10 Phone. For setting details, see [Microsoft Exchange ActiveSync device policy](#).

The screenshot shows the XenMobile interface with the 'Configure' tab selected. Under 'Device Policies', the 'Exchange Policy' configuration page is open. The left sidebar shows a navigation menu with '1 Policy Info' selected. The main content area is titled 'Exchange Policy' and includes a sub-header: 'This policy configures Microsoft Exchange ActiveSync so users can run Exchange email on their devices. When you create this policy, you need the host name or IP address for the Exchange Server.' Below this, there are several input fields: 'Account name or display name*' (exchange), 'Server name or IP address*' (170.10.10.10), 'Domain' (Suser.domainname), 'User ID or user name*' (Susersamaccountname), and 'Email address*' (Suser.mail). There is also a toggle for 'Use SSL connection' which is turned 'ON'. Under 'Sync items', there is a dropdown for 'Past days to sync' (Last 3 days). Under 'Sync scheduling', there are dropdowns for 'Frequency' (When item arrives) and 'Logging level' (Disabled). At the bottom, there is a section for 'Deployment Rules'. The left sidebar lists platform options: iOS, Mac OS X, Android HTC, Android TouchDown, Android for Work, Samsung SAFE, Samsung KNOX, Windows Phone, and Windows Desktop/Tablet (checked).

- **Active Directory user names now stored using lowercase letters.** As of this release, XenMobile stores all Active Directory user names using lowercase letters. This change applies to Active Directory users in the XenMobile database when it's upgraded and to new Active Directory users. This change doesn't apply to local user names.
- **Page loading, filtering, sorting, and searching device queries are now three times faster.** This optimization is a result of decoupling device count and query optimization while querying for a list of devices based on a given criteria. XenMobile Server can now fetch device counts dynamically.
- **The VPN policy for iOS devices now has per-app VPN options for the IPSec connection type.** iOS 9.0 and later devices support per-app VPN for IPSec connections. Netskope and other Cloud Access Security Brokers (CASBs) might recommend per-app VPN connections for IPSec.

The per-app VPN options are **Enable per-app VPN**, **On-demand match app enabled**, and **Safari domains**.

The screenshot shows the XenMobile configuration interface for a VPN Policy. The left sidebar lists various platforms, with 'iOS' selected. The main area displays the configuration for an IPSec connection. Key settings include:

- Connection name:** vpn1
- Connection type:** IPSec (highlighted with a purple box)
- Server name or IP address:** example.vpn.net
- Authentication type for the connection:** Shared Secret
- Use hybrid authentication:** OFF
- Prompt for password:** OFF
- Per-app VPN:**
 - Enable per-app VPN:** ON (highlighted with a purple box, with a note 'iOS 9.0+')
 - On-demand match app enabled:** OFF

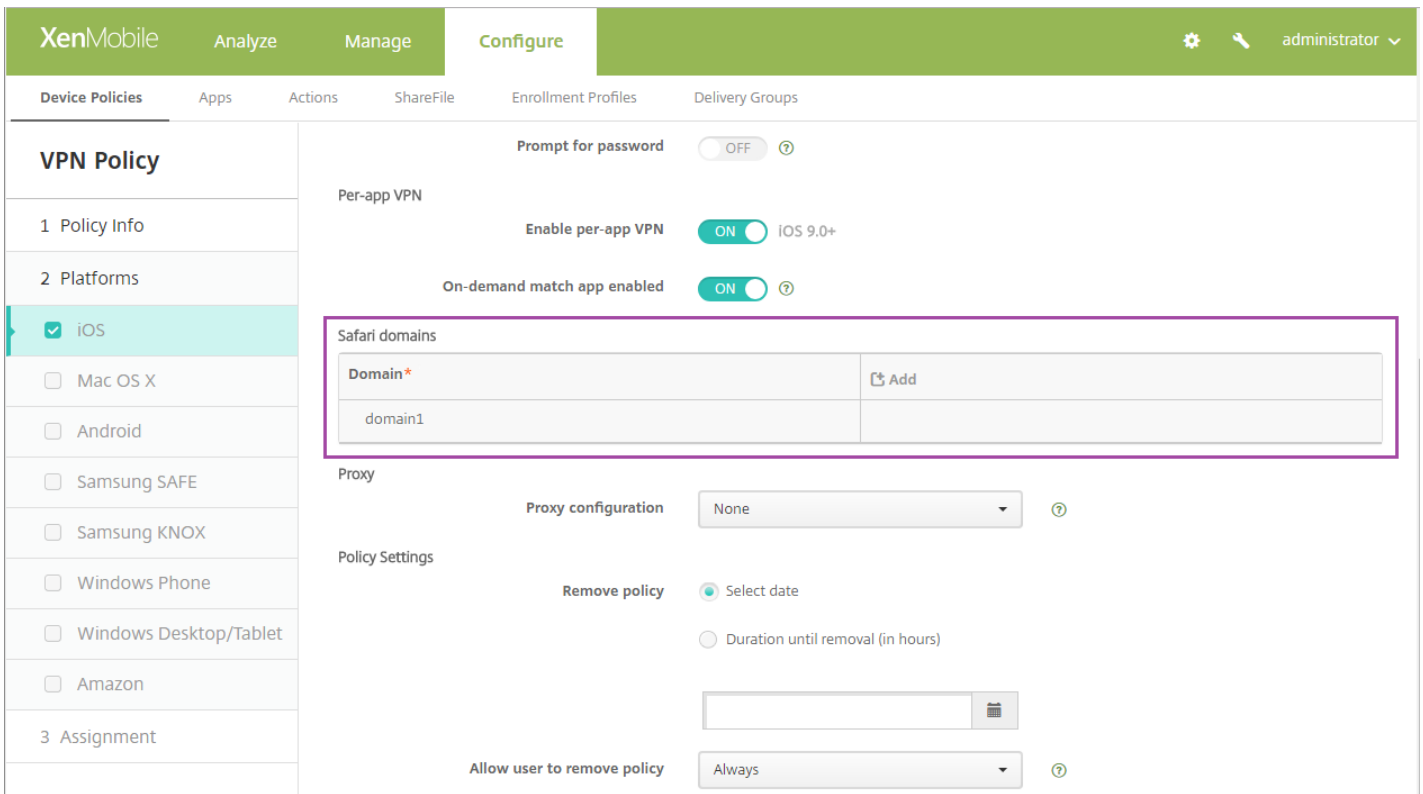

- **iOS Volume Purchase Program license revocation by user groups or in bulk.** You can now also disassociate Volume Purchase Program licenses for user groups or for all assignments to free licenses in bulk.

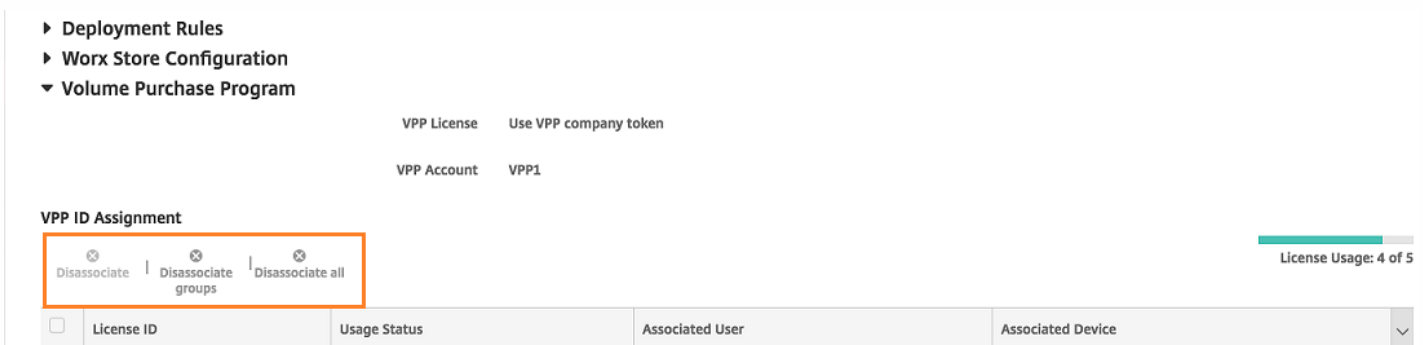

- **Delete multiple Active Directory users at a time.** The menu bar that appears when you select one or more Active Directory users now includes the **Delete** command. Previously, the **Delete** command appeared only in the right-click menu for a single user.

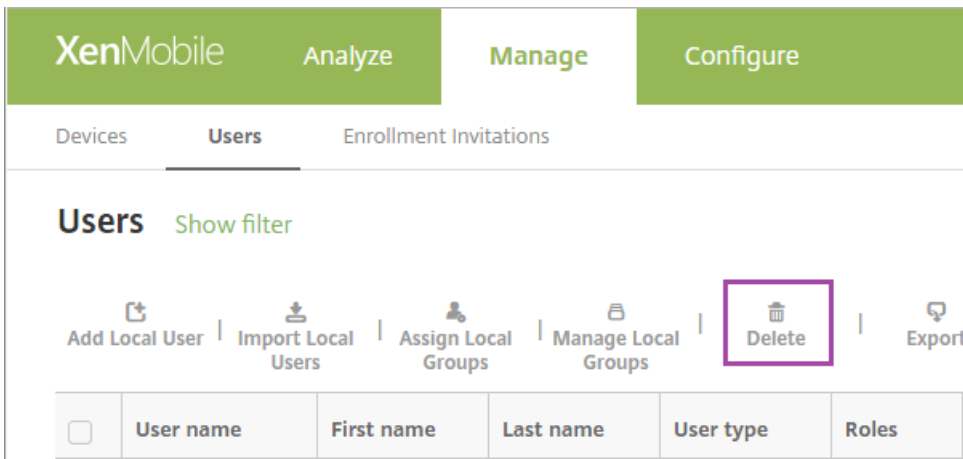

If a user that you delete has enrolled devices and you want to re-enroll those devices, delete the devices before re-enrolling them. To delete a device, go to **Manage > Devices**, select the device, and then click **Delete**.

- **Control whether the Common SAFE passcode field is editable.** To prevent inadvertent changes to the **Common SAFE passcode**, the Kiosk policy has a new setting, **Change Common SAFE passcode**. By default, the new setting is **OFF**. To change the passcode, set **Change Common SAFE passcode** to **ON** and then type a value for the passcode.

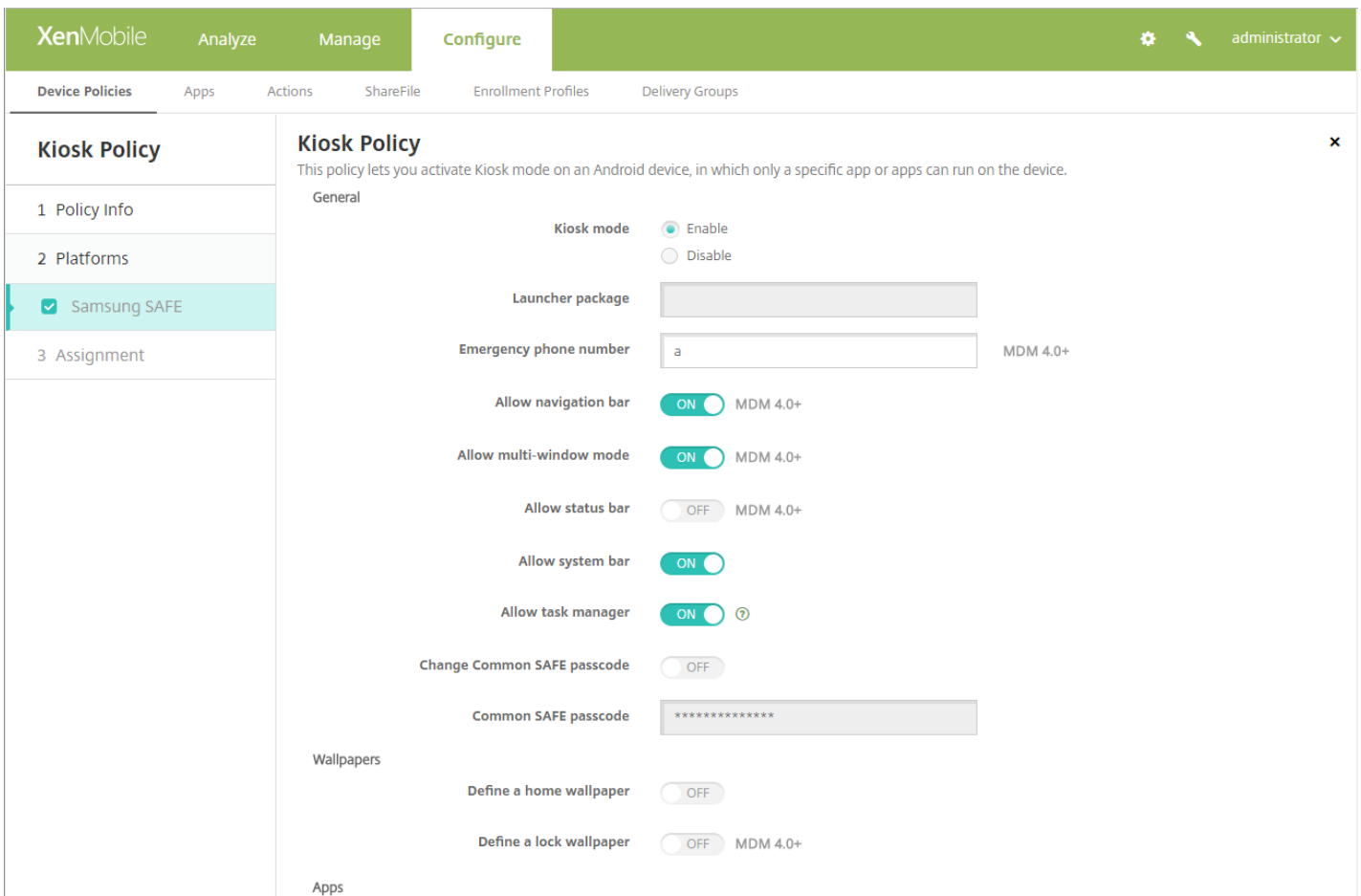

- **Filter the device policy list when adding a policy.** On the **Configure > Device Policies** page, when you click **Add**, the following page now appears. You can search for a policy by name, as before. You can also filter the list, to view the

device policies for selected platforms.

The **Add a New Policy** page initially shows a list of device policies and platform filters.

The screenshot shows the 'Add a New Policy' page in the XenMobile interface. The left sidebar lists various platforms with their respective counts. The main content area displays a search bar and a grid of policy categories. The categories are: Policies most often used, Apps, Security, and End user. Each category lists specific policies such as Exchange, Location, Passcode, Restrictions, Scheduling, Terms & Conditions, VPN, WiFi, Network access, App Access, App Attributes, App Configuration, App Inventory, App Network Usage, App Uninstall, App Uninstall Restrictions, Browser, Delete Files and Folders, Android for Work App Restrictions, App Lock, App Restrictions, Contacts (CardDAV), Copy Apps to Samsung Container, Credentials, Defender, Kiosk, Managed Domains, AirPlay Mirroring, AirPrint, Calendar (CalDav), Device Name, Font, Home Screen Layout, LDAP, MDM Options, Activate Windows, Go to Settings to activate Windows, and Mail.

Click one or more platforms to view a list of the device policies for the selected platforms. Click a policy name to continue with adding the policy.

The screenshot shows the 'Add a New Policy' page in the XenMobile interface. The left sidebar lists various platforms with their respective counts. The main content area displays a search bar and a grid of policy categories. The categories are: Policies most often used, Apps, and Security. Each category lists specific policies such as Exchange, Passcode, Terms & Conditions, VPN, WiFi, App Inventory, App Uninstall, and Credentials.

- **Apple Mail Drop support added to the Mail device policy.** You can now allow use of Apple Mail Drop for devices running iOS 9.2 and later. Mail Drop lets users upload files that are too large to send as an email attachment. Users can upload files up to 5 GB and then use the Mail app on their iOS device to send a link or preview to recipients.

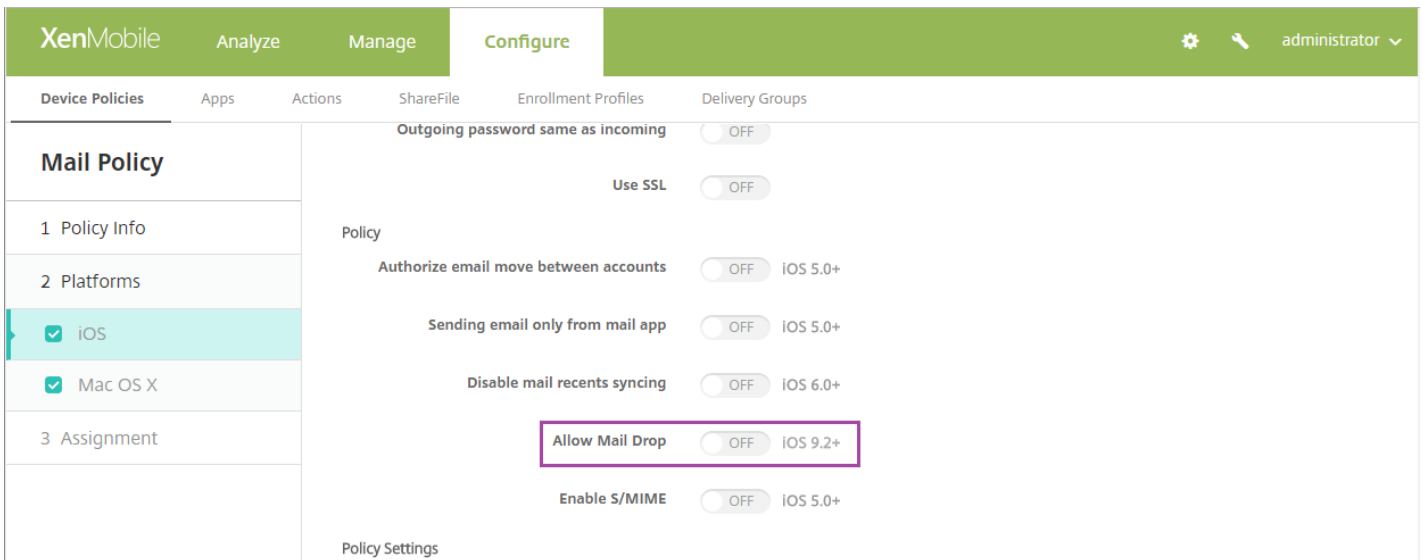

- **Device details logged for a wipe or lock of MAM-only devices.** When a MAM-only device gets wiped or locked, XenMobile logs now include the device ID and user name.
- **Support for Windows 10 RS2.** We certified XenMobile 10.5.3 and 10.5.2 with Windows 10 RS2 Phone and Tablet. XenMobile 10.5.1, 10.5.0, 10.4, and 10.3.x are compatible with Windows 10 RS2 Phone and Tablet.
- **Full wipe of Windows Desktop and Tablet devices.** You can now perform a full wipe to erase all personal and corporate data and apps from a Windows Desktop or Tablet device. From **Manage > Devices**, select a Windows Desktop/Tablet device, click **Secure**, and then click **Full Wipe**. On a desktop device, the remote wipe triggers the Windows **Reset this PC** command with the **Remove everything** option.

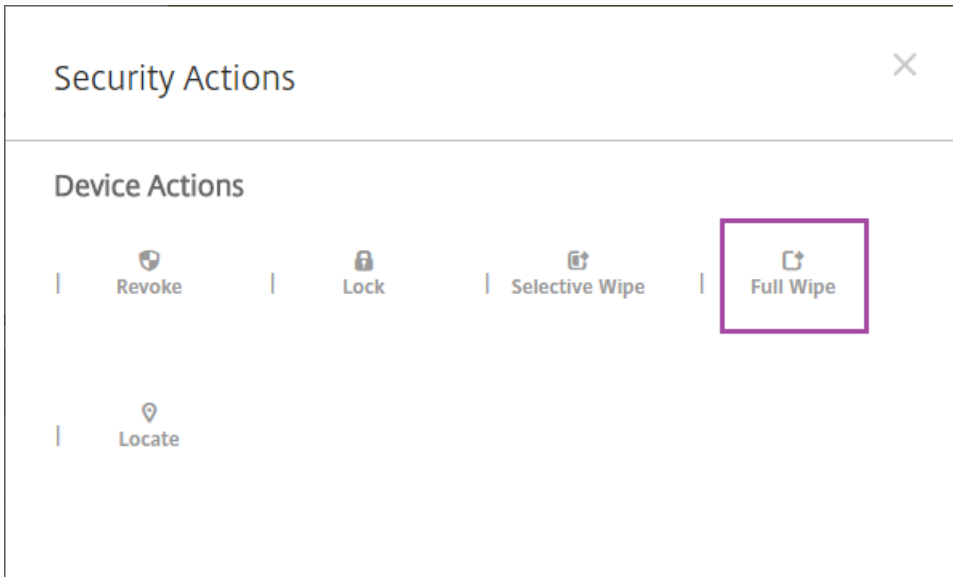

After you click **Full Wipe**, the **Device Actions** list includes **Cancel Wipe**. You can cancel a wipe before XenMobile deploys the wipe request.

Users can also wipe their Windows Desktop or Tablet device in the Self Help Portal.

XenMobile logs include wipe and cancel wipe events.

- The **Duration until removal option** for all iOS device policies has changed from days to hours. This latest version of XenMobile converts existing values to hours.
- **Improved performance of device queries and device filter expansion.** XenMobile now handles queries for device filter counts separately from device queries. When you expand a filter on the **Manage > Devices** page, spinners appear in place of filter counts until the counts are available.
- The **Troubleshooting and Support** page now includes a link to the XenMobile Analyzer.

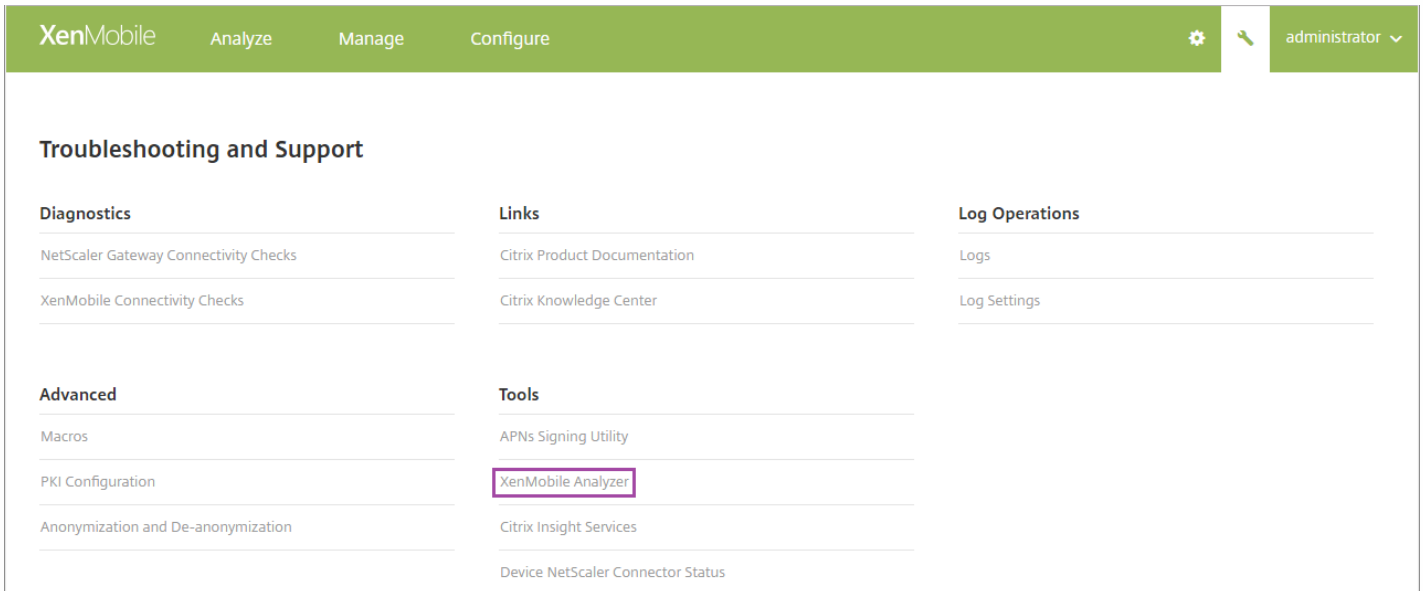

- **New XenMobile CLI option to specify SSL protocols.** You can now use the CLI to specify which SSL protocols XenMobile uses. The protocols allowed are:
 - TLSv1.2
 - TLSv1.1
 - TLSv1

By default, XenMobile enables each of those SSL protocols. When you change the SSL protocol setting, you must restart XenMobile Server.

To enable or disable protocols:

1. Open the XenMobile CLI, choose **[2] System**, and choose **[12] Advanced Settings**.

```
***** WARNING *****
Please only modify these options if you are
in contact with Citrix Support
*****

-----
Advanced Settings
-----
[0] Back to System Menu
[1] Toggle FIPS mode
[2] Custom Ciphers
[3] SSL protocols
[4] Reset SSL Certificate
[5] Reset pki.xml
[6] Server Tuning
-----
```

2. Choose **[3] SSL protocols**.
3. After the prompt **New SSL protocols to enable**, type the protocols you want to enable. XenMobile disables any protocols that you don't include in your response. For example: To disable TLSv1, type **TLSv1.2,TLSv1.1** and then type **y** to restart XenMobile Server.

```
-----
Advanced Settings
-----
[0] Back to System Menu
[1] Toggle FIPS mode
[2] Custom Ciphers
[3] SSL protocols
[4] Reset SSL Certificate
[5] Reset pki.xml
[6] Server Tuning
-----
Choice: [0 - 6] 3
  SSL protocols allowed: TLSv1.2,TLSv1.1,TLSv1
  SSL protocols enabled: TLSv1.2,TLSv1.1,TLSv1
  New SSL protocols to enable: TLSv1.2, TLSv1.1

Applying new SSL protocols configuration...
Are you sure to restart the system? [y/n]: █
```

What's new in XenMobile Server 10.5

Jul 11, 2017

Note

For the full set of product documentation for XenMobile Server 10.5, see the [PDF](#).

XenMobile Server 10.5 included the following new features. For information about known and fixed issues, see [Known issues](#) and [Fixed issues](#) later in this article.

Simplified management and deployment of ShareFile StorageZone Connectors

You can now use the XenMobile console to configure StorageZone Connectors. Offered as an alternative to using XenMobile with ShareFile Enterprise, the option to use XenMobile with StorageZone Connectors:

- Provides secure mobile access to existing on-premises storage repositories, such as SharePoint sites and network file shares. Doesn't require that you set up a ShareFile subdomain, provision users to ShareFile, or host ShareFile data.
- Provides users with mobile access to data through the ShareFile XenMobile Apps for iOS. Users can edit Microsoft Office documents. Users can also preview and annotate Adobe PDF files from mobile devices.
- File access is limited to the connectors. Users don't have access to other ShareFile functionality such as data sharing or syncing.
- Complies with security restrictions against leaking user information outside of the corporate network.
- Provides simple setup of StorageZone Connectors through the XenMobile console. If you later decide to use the full ShareFile functionality with XenMobile, you can change the configuration in the XenMobile console.
- Requires XenMobile Enterprise Edition.

The following diagram shows the high-level architecture for XenMobile use with StorageZone Connectors.

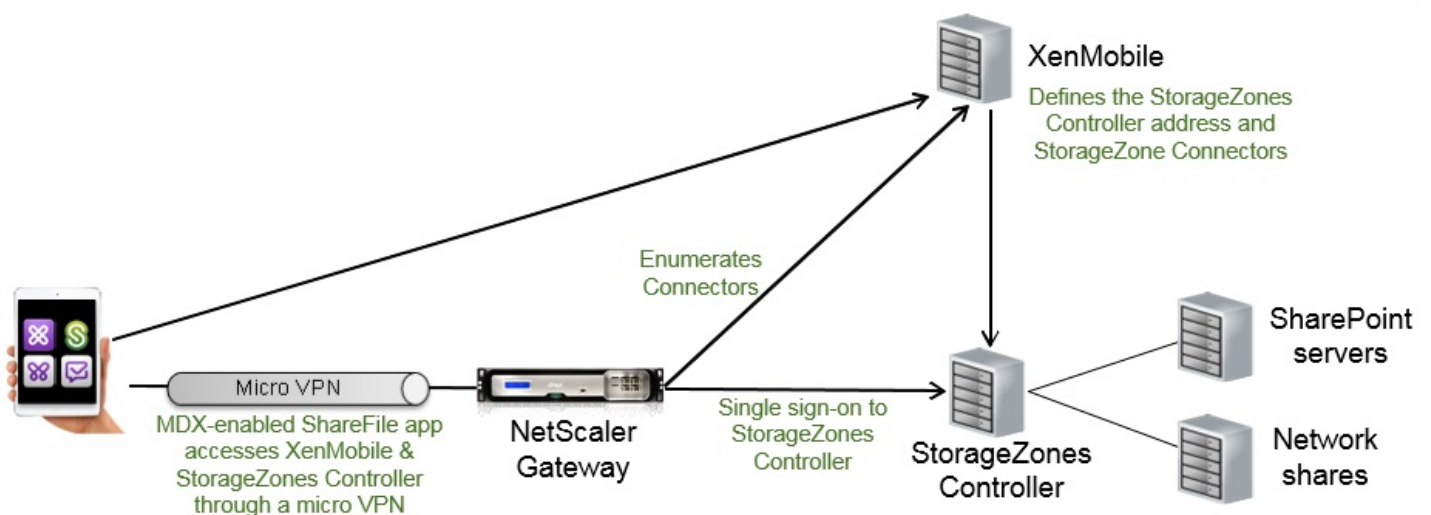

On your first visit to the **Configure > ShareFile** page, a description of the differences between using XenMobile with ShareFile Enterprise and with StorageZone Connectors appears.

XenMobile Analyze Manage **Configure** ⚙️ 🔍 administrator

Device Policies Apps Actions **ShareFile** Enrollment Profiles Delivery Groups

Choose a method for integrating ShareFile with XenMobile or learn more about which mode to select.

	ShareFile Enterprise	StorageZone Connectors Only
Access network shares and SharePoint data from mobile devices	✓	✓
Edit Microsoft Office documents from mobile devices	✓	✓
Preview and annotate Adobe PDF files from mobile devices	✓	✓
Store data in Citrix-managed or customer-managed StorageZones or both	✓	
Securely share files with people inside and outside the enterprise	✓	
Sync files and data across multiple devices	✓	
Access files through the ShareFile website	✓	
Access Office 365 content and Personal Cloud connectors from mobile devices	✓	
Use auditing and reporting capabilities	✓	

Configure ShareFile Enterprise **Configure Connectors**

If you click **Configure Connectors**, you provide information about the connectors and the StorageZones Controller.

XenMobile Analyze Manage **Configure** ⚙️ 🔍 administrator

Device Policies Apps Actions **ShareFile** Enrollment Profiles Delivery Groups

StorageZone Connector

- 1 Connector Info
- 2 Delivery Group Assignment (Optional)
- 3 Summary

Connector Info ✕

Configuring a connector will allow end users to connect to their existing SharePoint sites and CIFS (Common Internet File System) based on their authorizations.

Connector Name*

Description

Type* SharePoint

StorageZone* iosDev Manage StorageZones

Location*

Manage StorageZones

Add New

Name*

FQDN*

Port*

Secure Connection ON

Administrator user na...*

Administrator passw...*

You can associate connectors with delivery groups when you create the connector.

XenMobile Analyze Manage **Configure** administrator

Device Policies Apps Actions **ShareFile** Enrollment Profiles Delivery Groups

StorageZone Connector

1 Connector Info

2 Delivery Group Assignment (Optional)

3 Summary

Delivery Group Assignment

Configure a connector to allow users to connect to existing SharePoint sites or network file shares based on their authorizations.

Assign to delivery groups

AllUsers

XM5-users

dg-test

Selected delivery groups

XM5-users

You can also associate connectors with delivery groups by using the **Configure > Delivery Groups** page.

For more information about integrating StorageZone Connectors with XenMobile, see [ShareFile use with XenMobile](#).

Renamed client properties

XenMobile client property names related to Citrix PIN have changed:

Old property name	New property name
-------------------	-------------------

Enable Worx PIN Authentication	Enable Citrix PIN Authentication
Worx PIN Type	PIN Type
PIN Strength Requirement	PIN Strength Requirement
Worx PIN Length Requirement	PIN Length Requirement
Worx PIN Change Requirement	PIN Change Requirement
Worx PIN History	PIN History

The property keys remain the same, as shown in the following sample:

XenMobile Analyze Manage Configure administrator

Settings > Client Properties

Client Properties

To change a property, select the property and then click Edit.

Add

<input type="checkbox"/>	Name	Key	Value	Description
<input type="checkbox"/>	Enable Citrix PIN Authentication	ENABLE_PASSCODE_AUTH	false	Enable Citrix PIN Authentication
<input type="checkbox"/>	Enable User Password Caching	ENABLE_PASSWORD_CACHING	false	Enable User Password Caching
<input type="checkbox"/>	Encrypt secrets using Passcode	ENCRYPT_SECRETS_USING_PASSCODE	false	Encrypt secrets using Pin or AD password
<input type="checkbox"/>	PIN Strength Requirement	PASSCODE_TYPE	Numeric	PIN Strength Requirement
<input type="checkbox"/>	PIN Type	PASSCODE_STRENGTH	Medium	PIN Type
<input type="checkbox"/>	PIN Length Requirement	PASSCODE_MIN_LENGTH	6	PIN Length Requirement
<input type="checkbox"/>	PIN Change Requirement	PASSCODE_EXPIRY	90	PIN Change Requirement
<input type="checkbox"/>	PIN History	PASSCODE_HISTORY	5	PIN History
<input type="checkbox"/>	Inactivity Timer	INACTIVITY_TIMER	15	Inactivity Timer
<input type="checkbox"/>	Enable FIPS Mode	ENABLE_FIPS_MODE	false	Enable FIPS Mode

Dashboard improvements

The XenMobile **Analyze > Dashboard** page has a responsive design for improved viewing on smaller devices. Other improvements include:

- The Installed Apps widget now shows the top 10 apps. To view other apps, use the search bar.
- To export Installed Apps as a CSV file:

- Choose an app and then export it to get a report for that app only.
- Choose no apps to get a report for all apps.
- The reports include the following information for an app: Name, Owner, Version, Size, ID, and Install time.
- The VPP Apps License Usage widgets now show all apps from the software inventory. You no longer have to search for an app.

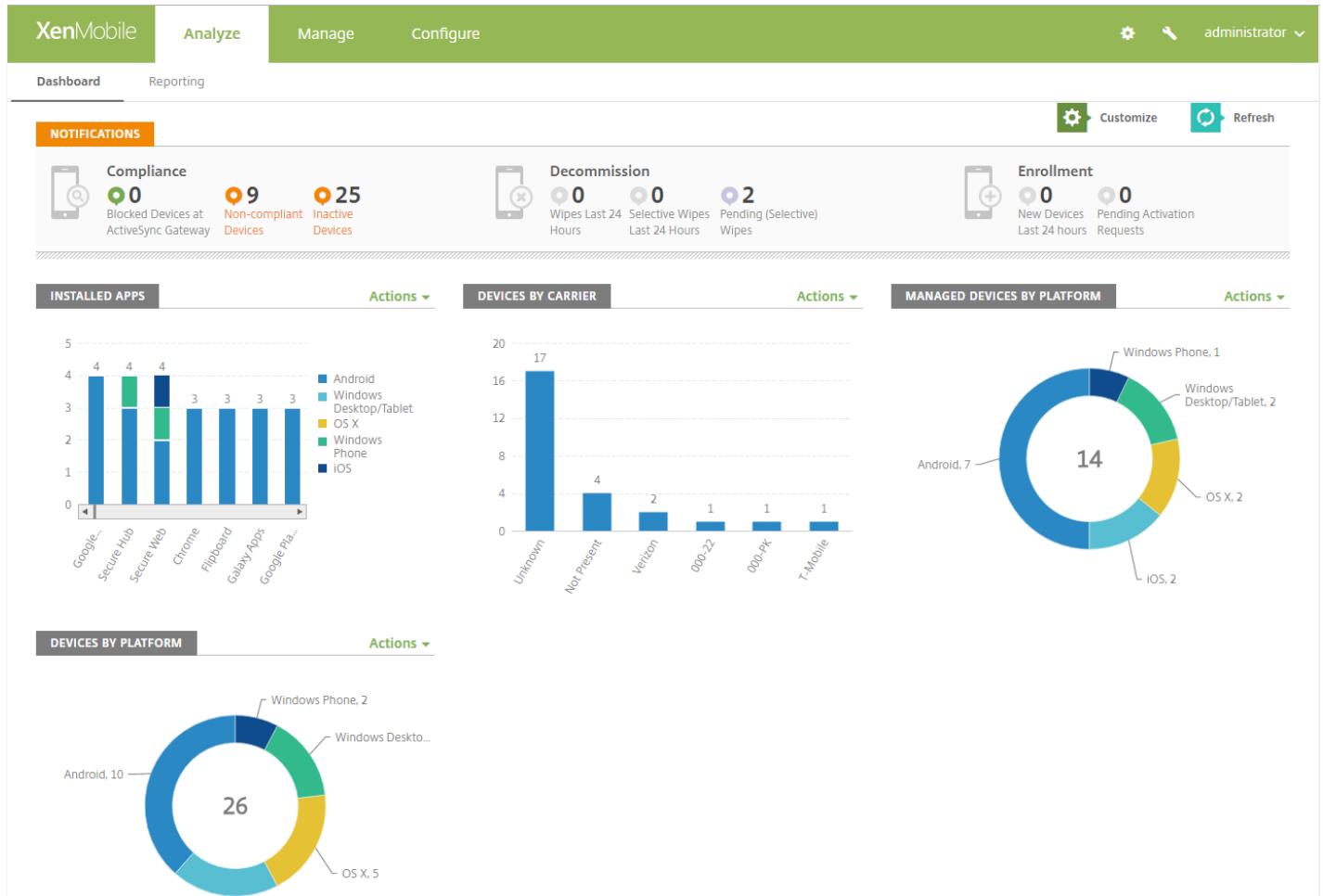

- The charts show counts in descending order.
- Each widget uses the best chart type for the information.
- The actions available for each widget appear in an **Actions** menu, which now includes only the actions most commonly performed from the dashboard:
 - **View Devices** - Opens the **Manage > Devices** page.
 - **Export as CSV** - Saves the data to a CSV file.

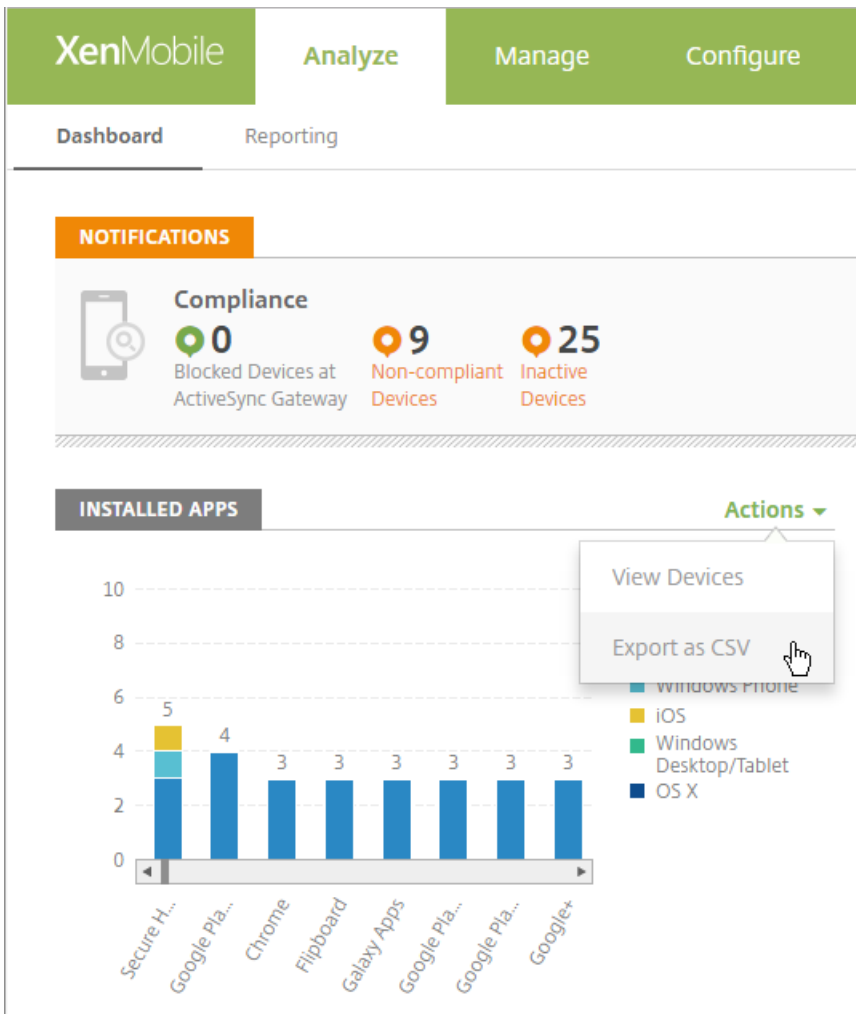

- The Export as CSV action exports the following information for each installed app:
 - Name
 - Version
 - Owner
 - Size
 - ID
 - Install time
- You can drill down to two levels of details for the following charts: Click a platform to see a bar chart for the version counts and then click a version to open the **Manage > Devices** page.
 - Devices By Platform
 - Managed Devices By Platform
 - Unmanaged Devices By Platform
 - Installed Apps
- To open the **Manage > Devices** page, click any of these charts:
 - Devices By Carrier
 - Devices By ActiveSync Gateway Status
 - Devices By Ownership
 - Android TouchDown License Status

Failed Delivery Group Deployments
 Devices By Blocked Reason
 VPP Apps License Usage

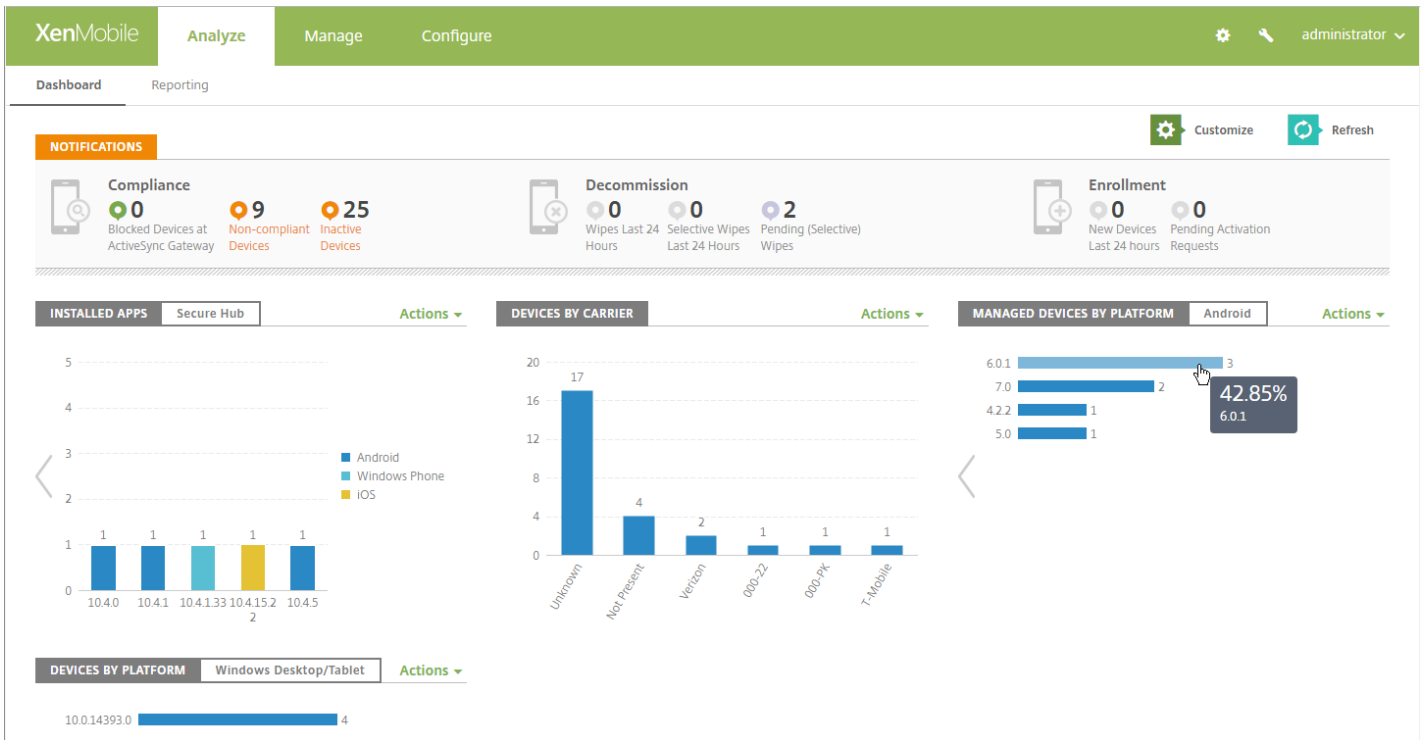

Test Connection buttons added to XenMobile console

The XenMobile console now includes a **Test Connection** button on these pages:

- **Configure > ShareFile:** You can use the **Test Connection** button to verify that the user name and password for the ShareFile administrator account authenticate to the specified ShareFile account.

XenMobile Analyze Manage **Configure**

Device Policies Apps Actions **ShareFile** Enrollment Profiles Delivery Groups

ShareFile

Configure settings to connect to the ShareFile account and administrator service account for user account management.

Domain*

Assign to delivery groups

AllUsers

Selected delivery groups

AllUsers

ShareFile Administrator Account Logon

User name*

Password*

User account provisioning OFF

SAML certificate

Name XMS.example.com

Advanced ShareFile Configuration

- **Settings > XenApp/XenDesktop:** You can use the **Test Connection** button to verify that XenMobile can connect to the specified XenApp and XenDesktop server.

XenMobile Analyze Manage **Configure**

Settings > [XenApp/XenDesktop](#)

XenApp/XenDesktop

Allows users to add XenApp and XenDesktop through Secure Hub.

Host*

Port*

Relative Path*

Use HTTPS OFF

Connection succeeded

Windows Defender device policy for Windows 10 for desktop and tablet

Windows Defender is malware protection included with Windows 10. You can use the XenMobile device policy, Defender, to configure the Microsoft Defender policy. To add the Defender policy, go to **Configure > Device Policies**, click **Add**, start typing **Defender**, and then click that name in the search results.

The screenshot shows the XenMobile configuration interface. The top navigation bar includes 'XenMobile', 'Analyze', 'Manage', and 'Configure'. The 'Configure' tab is active, and the 'Device Policies' sub-tab is selected. A sidebar on the left shows the 'Defender' policy details, with 'Windows Desktop/Tablet' selected under the 'Platforms' section. The main content area displays the 'Defender' policy configuration for Windows 10 desktop and tablet. The policy description states: 'This policy configures Windows Defender settings in Windows 10 for desktop and tablet.' The configuration options are as follows:

- Allows scanning of archives: OFF
- Allows cloud protection: ON
- Allows a full scan of removable drives: ON
- Allows Windows Defender Real-time Monitoring functionality: ON
- Allows scanning of network files: ON
- Allows user access to the Windows Defender UI: ON
- Excluded extensions: (empty text box)
- Excluded paths: (empty text box)
- Excluded processes: (empty text box)
- Submit samples consent: Send safe samples

At the bottom, there is a section for 'Deployment Rules'.

WiFi device policy support for Windows 10

The WiFi device policy now includes support for Windows 10, enabling you to use client certificate authentication for your WiFi network. To update WiFi device policies, go to **Configure > Device Policies**.

XenMobile Analyze Manage **Configure**

Device Policies Apps Actions ShareFile Enrollment Profiles Delivery Groups

WiFi Policy

1 Policy Info

2 Platforms

- iOS
- Mac OS X
- Android
- Windows Phone
- Windows Desktop/Tablet
- Windows Mobile/CE

3 Assignment

WiFi Policy

This policy lets you configure a WiFi profile for devices.

Network name* ⓘ

Authentication

Encryption

EAP Type

Connect if hidden OFF

Connect automatically ON

Push certificate via SCEP ON

Credential provider for SCEP*

Proxy server settings

Host name or IP address

Port

Bulk enrollment of macOS devices

The Apple Device Enrollment Program (DEP) setting in XenMobile now supports macOS devices running OS X 10.10 or later. You follow the same process as described in [Bulk enrollment of iOS and macOS devices](#). If you add a DEP account from **Settings > Apple Device Enrollment Program (DEP)**, the **Settings** and **Setup Assistant Options** now includes a page for macOS.

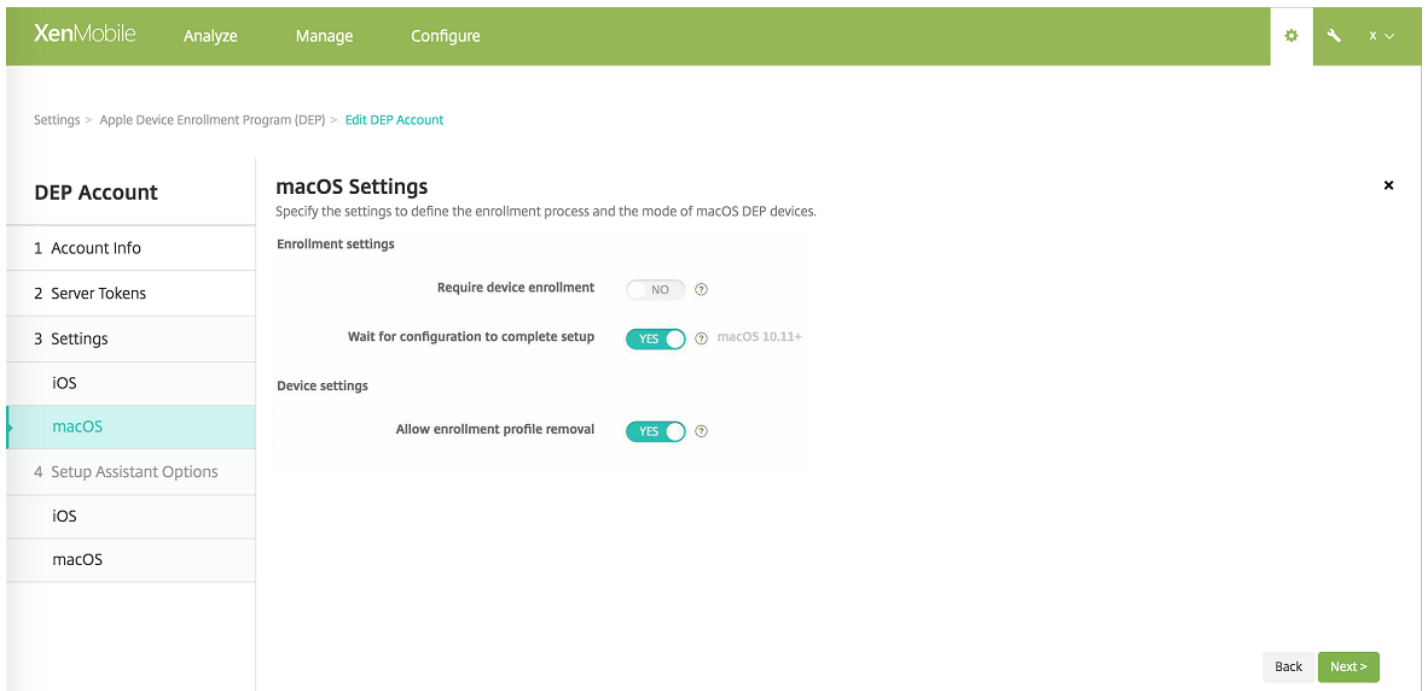

Enrollment settings

- **Require device enrollment:** Whether to require users to enroll their devices. The default is **Yes**.
- **Wait for configuration to complete setup:** If you enable this setting, the macOS device doesn't continue in the Setup Assistant until the MDM resource passcode deploys to the device. The MDM resource passcode deployment occurs before the local account is created. This setting is available for macOS 10.11 and later devices. The default is **No**.

Device settings

- **Allow enrollment profile removal:** Whether to allow devices to use a profile that you can remove remotely. The default is **No**.

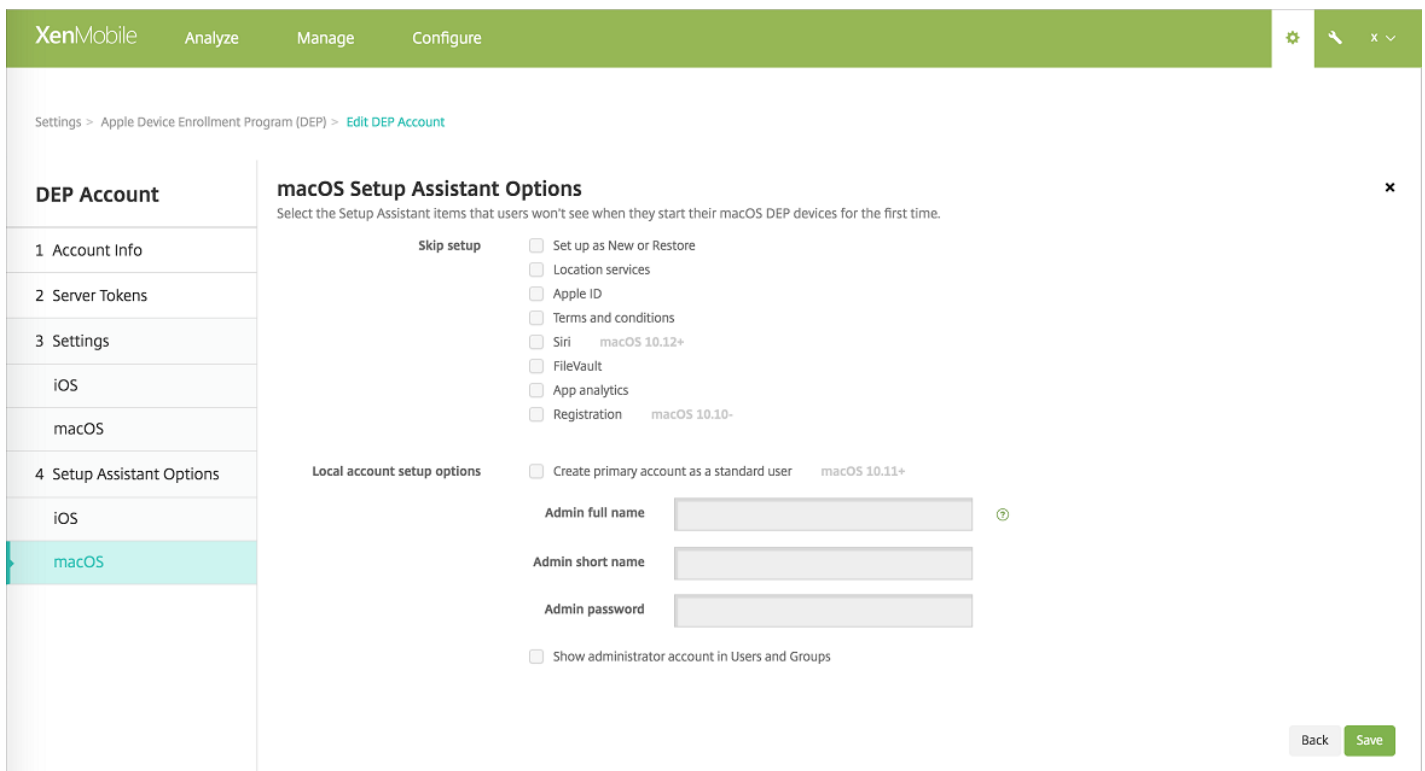

- **Set up as New or Restore:** Set up the device as new or from an iCloud or iTunes backup.
- **Location services:** Set up the location service on the device.
- **Apple ID:** Set up an Apple ID account for the device.
- **Terms and conditions:** Require users to accept terms and conditions for use of the device.
- **Siri:** Use or not use Siri on the device.
- **FileVault:** Use FileVault to encrypt the startup disk. XenMobile applies the FileVault setting only if the system has a single local user account that is signed in to iCloud.

You can use the macOS FileVault Disk Encryption feature to protect the system volume by encrypting its contents. See the Apple support article, <https://support.apple.com/en-us/HT204837>. If you run the Setup Assistant on a late-model portable Mac on which FileVault is off, you might be prompted to turn on this feature. If the system meets the following requirements, the prompt appears on new systems and on systems upgraded to OS X 10.10 or 10.11:

- The system has a single local administrator account
- That account is signed in to iCloud
- **App analytics:** Set up whether to share crash data and usage statistics with Apple.
- **Registration:** Require users to register their device.

Registration information setup was available through OS X 10.9. The registration process enabled you to send system registration information to Apple. This information associated your contact information with the Mac hardware. Apple primarily used the information to assist Apple support. If you previously specified an Apple ID, Setup Assistant optionally submitted the registration based on your Apple ID account. If you didn't specify an Apple ID, you can manually type your contact information.

- Under **Local account setup options**, specify the settings to create an administrator account, which is required for macOS. XenMobile creates the account, using the specified information.

Support for multiple Apple Device Enrollment Program accounts for iOS and macOS devices

You can now define multiple Apple Device Enrollment Program (DEP) accounts. This feature enables you to use different enrollment settings, device settings, and Setup Assistant options. You can specify those settings and options by country, department, and other structures. You then associate DEP accounts with different device policies and different apps through deployment rules.

For example, you might centralize all your DEP accounts from different countries on the same XenMobile Server. You can then import and supervise all DEP devices. By customizing enrollment settings per country or other structure, you ensure that policies provide appropriate functionality across your organization. By customizing Setup Assistant options per country or other structure, you ensure that device users receive the appropriate setup assistance.

To accommodate support for multiple DEP accounts, the following pages replace **Settings > iOS Bulk Enrollment**:

- **Settings > Apple Device Enrollment Program (DEP)**: Use this page is to:
 - Create DEP accounts.
 - Configure enrollment settings, iOS and macOS device settings, and Setup Assistant options per each account.

XenMobile Analyze Manage Configure

Settings > Apple Device Enrollment Program (DEP)

Apple Device Enrollment Program (DEP)

Apple Device Enrollment Program (DEP) streamlines the enrollment and management of iOS and macOS devices in XenMobile. The DEP notifies Apple servers about a device profile, which customizes the setup assistant experience and assigns the profile to specific devices. These steps assume an Apple ID for the organization has already been created, as outlined in the [Device Enrollment Program Guide](#).

- 1 Download Public Key**
A Public Key will be automatically generated for you and signed by Citrix.
[Download](#)
- 2 Create a Server Token file**
 - Sign in to [Apple Deployment Programs Portal](#) with your corporate Apple ID.
 - Navigate to Device Enrollment Program > Manage Servers. Click Add MDM Server.
 - Enter a MDM Server Name, then click Choose File... and upload your Public Key.
 - Download the Server Token file provided.[Add](#)
- 3 Add DEP Account**
Follow the wizard to add the account.
[Add](#)

Settings > Apple Configurator Device Enrollment: Used to prepare iOS and macOS devices and to configure policies.

Settings > [Apple Configurator Device Enrollment](#)

Apple Configurator Device Enrollment

Use Apple Configurator to mass configure and deploy iPhone, iPad or iPod Touch.



Export anchor
certificates

Enable Apple Configurator device enrollment YES

Enrollment URL to enter in Apple
Configurator

<https://example.domain.net:8443/zdm/ios/otae/dobulkenrollment>

Require device registration before enrollment NO

Require credentials for device enrollment YES iOS 7.1+

Cancel

Save

iOS Home screen layout

Use the new Home Screen Layout device policy to specify the layout of apps and folders for the iOS Home screen. This policy is supported on iOS 9.3 and later supervised devices. To add the policy, go to **Configure > Device Policies**.

XenMobile Analyze Manage **Configure** administrator

Device Policies Apps Actions ShareFile Enrollment Profiles Delivery Groups

Home Screen Layout Policy

This policy defines a layout of apps and folders for the home screen. It is supported only on iOS 9.3 and later supervised devices. For an application you should enter the bundle identifier as value. For a folder, you should enter a list of bundle identifiers separated with a comma.

Dock

Type	Display Name*	Value*	Add
			+

Page 1

Type	Display Name*	Value*	Add
			+

Page 2

Type	Display Name*	Value*	Add
			+

Page 3

Type	Display Name*	Value*	Add
			+

Page 4

Type	Display Name*	Value*	Add
			+

Page 5

Type	Display Name*	Value*	Add
			+

Policy Settings

Remove policy Select date Duration until removal (in days)

Allow user to remove policy

XenMobile Analyze Manage **Configure** administrator

Device Policies Apps Actions ShareFile Enrollment Profiles Delivery Groups

Home Screen Layout Policy

This policy defines a layout of apps and folders for the home screen. It is supported only on iOS 9.3 and later supervised devices. For an application you should enter the bundle identifier as value. For a folder, you should enter a list of bundle identifiers separated with a comma.

Dock

Type	Display Name*	Value*	Save	Cancel
Application	<input type="text"/>	<input type="text"/>	Save	Cancel

Page 1

Type	Display Name*	Value*	Add
			+

More feature restriction options for iOS devices

The Restrictions Policy for iOS now includes these additional restriction options:

- **News:** Allow users to use the News app (available in iOS 9.0 and later). Applies only to supervised devices.

- **Apple Music service:** Allow users to use the Apple Music service (available in iOS 9.3 and later). If you don't allow Apple Music service, the Music app runs in classic mode. Applies only to supervised devices.
- **iTunes Radio:** Allow users to use iTunes Radio (available in iOS 9.3 and later). Applies only to supervised devices.
- **Notifications modification:** Allow users to change notification settings (available in iOS 9.3 and later). Applies only to supervised devices.
- **Restricted App usage:** Allow users to use all apps or only the apps allowed or denied by bundle ID (available in iOS 9.3 and later). Applies only to supervised devices.
- **Diagnostic submission modification:** Allow users to change the diagnostic submission and app analytics settings in the Diagnostics & Usage pane in Settings (available in iOS 9.3.2 and later). Applies only to supervised devices.
- **Bluetooth modification:** Allow users to change Bluetooth settings (available in iOS 10.0 and later). Applies only to supervised devices.

The screenshot shows the XenMobile 'Configure' interface. The top navigation bar includes 'XenMobile', 'Analyze', 'Manage', and 'Configure'. Below this is a sub-navigation bar with 'Device Policies', 'Apps', 'Actions', 'ShareFile', 'Enrollment Profiles', and 'Delivery Groups'. The main content area is titled 'Restrictions Policy' and has a left sidebar with options: '1 Policy Info', '2 Platforms', 'iOS' (checked), 'Mac OS X', 'Samsung SAFE', 'Samsung KNOX', and 'Windows Phone'. The main area displays the following settings:

- News:** OFF (iOS 9.0+)
- Apple Music service:** OFF (iOS 9.3+)
- iTunes Radio:** OFF (iOS 9.3+)
- Notifications modification:** OFF (iOS 9.3+)
- Restricted App usage:** Allow all apps (dropdown menu)
- Diagnostic submission modification:** OFF (iOS 9.3.2+)
- Bluetooth modification:** OFF (iOS 10.0+)

More feature restriction options for macOS devices

The Restrictions Policy has the following added restriction options for macOS 10.12 and later. By default, XenMobile allows these features.

- Allow Apple Music: If you don't allow Apple Music service, the Music app runs in classic mode. Applies only to supervised devices.
- Allow iCloud Keychain Sync
- Allow iCloud Mail
- Allow iCloud Contacts
- Allow iCloud Calendars
- Allow iCloud Reminders
- Allow iCloud Bookmarks
- Allow iCloud Notes

The screenshot shows the XenMobile configuration interface. At the top, there are tabs for 'XenMobile', 'Analyze', 'Manage', and 'Configure'. Below these are sub-tabs: 'Device Policies', 'Apps', 'Actions', 'ShareFile', 'Enrollment Profiles', and 'Delivery Groups'. The 'Restrictions Policy' is selected on the left sidebar, with 'Mac OS X' highlighted. The main content area shows 'Policy Settings' for Mac OS X, including various iCloud-related settings (Look Up, documents & data, Keychain Sync, Mail, Contacts, Calendars, Reminders, Bookmarks, Notes) and a 'Remove policy' section with options for 'Select date' and 'Duration until removal (in days)'. There are also dropdown menus for 'Allow user to remove policy' (set to 'Always') and 'Profile scope' (set to 'User').

Support for iOS 9.3 Managed Lost Mode

In iOS 9.3 or later, you can use Apple MDM to place a supervised device into Managed Lost Mode, a dedicated mode. You can use Managed Lost Mode to block or locate supervised devices that are lost or stolen.

XenMobile now has a Lost Mode device property. Unlike Apple Managed Lost Mode, XenMobile Lost Mode doesn't require a user to perform either of the following actions to enable locating their device: Configure the Find My iPhone/iPad setting or enable the Location Services for Citrix Secure Hub.

The XenMobile Lost Mode feature is similar to the XenMobile device lock feature. However, in XenMobile Lost Mode, only the XenMobile Server can unlock the device. By using device lock, users can unlock the device directly by using a PIN code provided by their administrator.

Note

In iOS 7 and later, you can also use iOS Device Lock to lock lost or stolen supervised or unsupervised devices remotely. Apple recommends that you avoid using iOS Device Lock for other purposes.

To enable or disable lost mode: Go to **Manage > Devices**, choose a supervised iOS device, and click **Secure**. Then, click **Enable Lost Mode** or **Disable Lost Mode**.

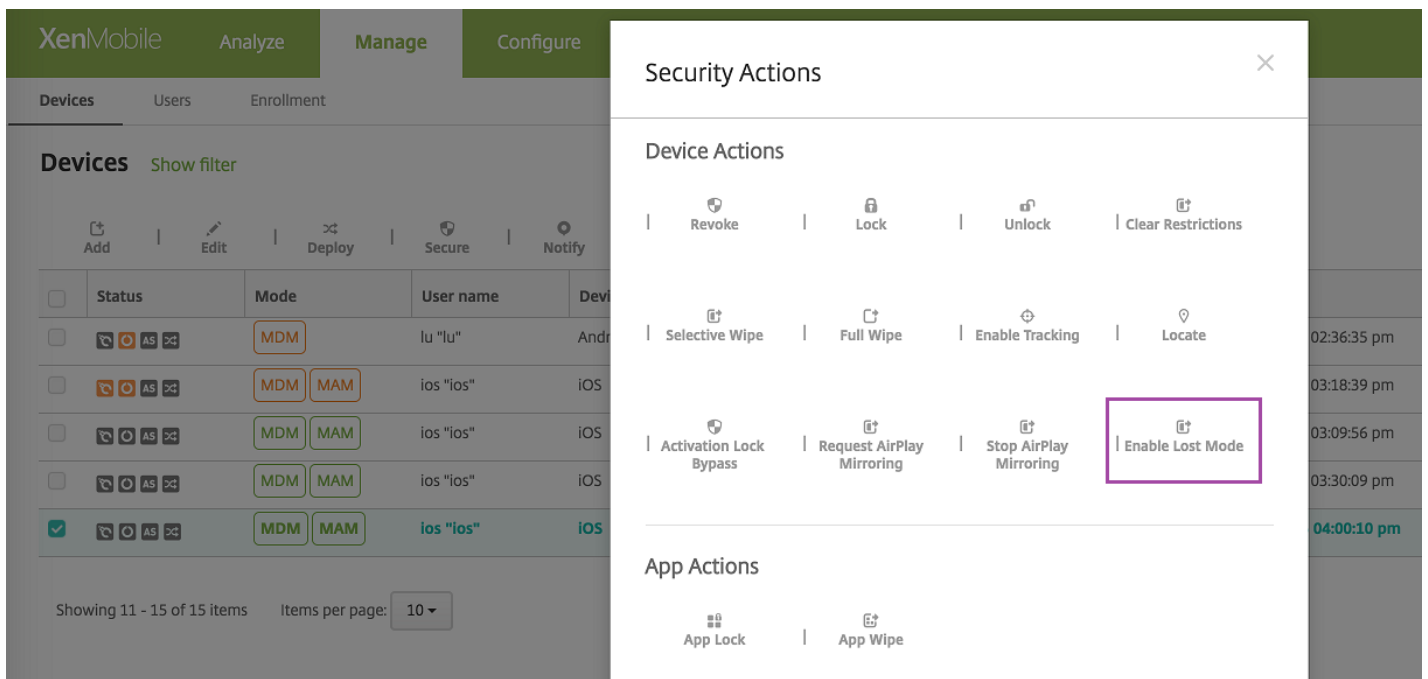

Use any of the following methods to check Lost Mode status:

- In the **Security Actions** window, verify if the button is **Disable Lost Mode**.
- From **Manage > Devices**, on the **General** tab under **Security**, see the last Enable Lost Mode or Disable Lost Mode action.

XenMobile Analyze Manage Configure administrator

Devices Users Enrollment Invitations

Device details

- 1 General
- 2 Properties
- 3 User Properties
- 4 Assigned Policies
- 5 Apps
- 6 Actions
- 7 Delivery Groups
- 8 iOS Profiles
- 9 iOS Provisioning Profiles
- 10 Certificates
- 11 Connections
- 12 MDM Status

Device Shutdown	No device shutdown.
Device locate	No device locate .
Device Enable Tracking	No device enable tracking.
Device Disown	No device disown.
DEP Activation Lock	No DEP device activation lock.
Activation Lock Bypass	No device activation lock bypass.
Device Clear Restrictions	No Clear Restrictions.
Device App Wipe	No device App Wipe.
Device App Lock	No device App Lock.
Request AirPlay Mirroring	No request AirPlay mirroring.
Stop AirPlay Mirroring	No stop AirPlay mirroring.
Enable Lost Mode	No lost mode enabled.
Disable Lost Mode	No lost mode disabled.

Next >

- From **Manage > Devices**, on the **Properties** tab, verify the value of the setting **MDM lost mode enabled**.

The screenshot shows the XenMobile console interface. At the top, there are tabs for 'Analyze', 'Manage', and 'Configure'. The 'Manage' tab is active, and the 'Devices' sub-tab is selected. On the left, a sidebar lists 'Device details' with sub-items 1 through 12. Item 2, 'Properties', is highlighted. The main content area displays a table of device properties:

Activation lock enabled	No
Hardware encryption capabilities	Block and file levels encryption
Internal storage encrypted	No
Jailbroken/Rooted	No
MDM lost mode enabled	No
Passcode compliant	Yes
Passcode compliant with configuration	Yes
Passcode present	No
Supervised	No
- Storage space Add	
Available storage space	10.92 GB
Total storage space	12.28 GB ×
- System information Add	
Active iTunes account	Yes
Cloud backup enabled	No

At the bottom right of the console, there are 'Back' and 'Next >' buttons.

If you enable XenMobile Lost Mode on an iOS device, the XenMobile console also changes as follows:

- In **Configure > Actions**, the **Actions** list doesn't include these automated actions: **Revoke the device**, **Selectively wipe the device**, and **Completely wipe the device**.
- In **Manage > Devices**, the **Security Actions** list no longer includes the **Revoke** and **Selective Wipe** device actions. You can still use a security action to perform a **Full Wipe** action, as needed.

For iPads running iOS 7 and later: iOS appends the words "Lost iPad" to what you type in the **Message** box of the **Security Actions** dialog box. For iPhones running iOS 7 and later: If you leave the **Message** box empty and provide a phone number, Apple displays the message "Call owner" on the device lock screen.

SmartAccess for HDX apps

The SmartAccess feature allows you to control access to HDX apps based on device properties, user properties, or installed applications. You can control access by using automated actions to mark the device as out of compliance. To use SmartAccess, configure HDX apps in XenApp and XenDesktop with a SmartAccess policy that denies access to out-of-compliance devices. XenMobile communicates device status to StoreFront using a signed, encrypted tag. StoreFront allows or denies access based on the access control policy of the app.

Other improvements

- **More languages supported.** The XenMobile console is now available in Japanese. Secure Hub is now available in Arabic and Russian.
- **WiFi device policy.** The WiFi device policy now includes support for Windows 10, enabling you to use client certificate

authentication for your WiFi network. To update WiFi device policies, go to **Configure > Device Policies**.

- **Test Connection button added to the PKI Entities page.** When you add a Microsoft Certificate Services entity, you can test the connection to ensure that the server is reachable.
- **Improved stability** through database optimizations.
- **Last access time changes for MAM-only devices.** Previously, the device statistics for devices registered in MAM mode used the device registration time as the last access time. XenMobile now uses the most recent of the last online authentication or last activity for the last access time. The **Manage > Devices** page now includes the last access time.
- **Managed Domains policy now includes Safari password autofill domains.** For iOS 9.3 and later supervised devices, you can now specify the URLs from which users can save passwords in Safari. To do that, go to **Configure > Device Policies**. Then, add or open the **Managed Domains Policy**, and complete the settings under **Safari Password AutoFill Domain**.

The screenshot shows the XenMobile console interface. The top navigation bar includes 'XenMobile', 'Analyze', 'Manage', and 'Configure'. The 'Configure' tab is active, and the user is logged in as 'administrator'. The main content area is titled 'Managed Domains Policy' and includes a description: 'This policy lets you define managed domains that apply to the Safari browser. The policy is supported only on iOS 8 and later devices.' The configuration is divided into three sections: 'Managed Email Domains', 'Managed Safari Web Domains', and 'Safari Password AutoFill Domains', each with an 'Add' button. Below these is the 'Policy Settings' section, which includes a 'Remove policy' section with radio buttons for 'Select date' (selected) and 'Duration until removal (in days)', a date picker, and an 'Allow user to remove policy' dropdown set to 'Always'. A 'Deployment Rules' section is partially visible at the bottom. Navigation buttons 'Back' and 'Next >' are at the bottom right.

- **TLS 1.2 required for Secure Hub.** Apple now requires App Transport Security (ATS) for all apps submitted to the Apple App Store. ATS uses the Transport Layer Security (TLS) protocol version 1.2, which is now the required server protocol for Secure Hub.
- **Console interface improvements for managing enrollment invitations.** To clarify the terminology, the XenMobile console has the following improvements:
 - The page **Manage > Enrollments** changed to **Manage > Enrollment Invitations**.
 - The **Enrollment Status** column changed to **Status**. As before, that column contains enrollment invitation status, not

enrollment status.

- The terminology used when you manage an enrollment invitation now matches the terminology used when creating the invitation. We changed these labels:

The **Type** column is now **Platform**.

The **Mode** column is now **Enrollment Mode**.

In the filter, the **Invitations Status** is now **Status**.

In the filter, the **Invitations Mode** is now **Enrollment Mode**.

- The value labels in the **Mode** column are now the same labels used when you create an invitation. For example, the **Mode** column now shows "User name" instead of "classic".

- **New server property to set the VPP license baseline minimum interval.** XenMobile periodically reimports VPP licenses from Apple to ensure that the licenses reflect all changes. Such changes include when you manually delete an imported app from VPP. By default, XenMobile refreshes the VPP license baseline a minimum of every 720 minutes. You can now change the baseline interval through the new server property, **VPP baseline interval** (vpp.baseline).

If you have more than 50,000 VPP licenses installed, Citrix recommends that you increase the baseline interval to reduce the frequency and overhead of importing licenses. If you expect frequent VPP license changes from Apple, Citrix recommends that you lower the value to keep XenMobile updated with the changes. The minimum interval between two baselines is 60 minutes.

In addition, XenMobile performs a delta import every 60 minutes, to capture the changes since the last import. Setting the VPP baseline minimum interval to 60 minutes might delay the interval between baselines up to 119 minutes.

- The **Certificates** tab for **Manage > Devices** now includes the number of days before NetScaler Gateway certificates expire.

XenMobile Analyze **Manage** Configure administrator

Devices Users Enrollment Invitations

Device details km1user1@test.net | ✕

1 General
2 Properties
3 User Properties
4 Assigned Policies
5 Apps
6 Actions
7 Delivery Groups
8 Certificates
9 Connections
10 TouchDown

Valid certificates

Type	Provider	Issuer	Serial number	Days to expire	Valid to
SHTP agent		CN=Devices Certificate Authority	10252	638	11/01/2018 04:02:52 pm
NetScaler Gateway Credentials		CN=tes-TEST-CA, DC=tes-DC=net	278759315087171164297948754067905	2	02/03/2017 02:52:15 pm

Showing 1 - 2 of 2 items

Expired or revoked certificates

Type	Provider	Issuer	Serial number	Days to expire	Valid to
No results found.					

- The **Manage > Devices** page and the **Properties** tab for devices now include the XenMobile agent revision and version numbers.

XenMobile Analyze **Manage** Configure administrator

Devices Users Enrollment Invitations

Devices Show filter

Add Import Export Refresh

<input type="checkbox"/>	Status	Mode	Device platform	Operating system version	Device model	XenMobile agent revision	XenMobile agent version
<input type="checkbox"/>		MDM MAM	iOS	10.1.1	iPhone	184	10.4.5
<input type="checkbox"/>		MDM MAM	iOS	8.4.1	iPhone	22	10.4.15
<input type="checkbox"/>		MDM MAM	Android	6.0.1	Nexus 5	382546	10.4.0
<input type="checkbox"/>		MDM MAM	Android	7.0	Nexus 9	381553	10.4.0

XenMobile Analyze Manage Configure ⚙️ 🔍 administrator ▾

Devices Users Enrollment Invitations

Device details

- 1 General
- 2 Properties**
- 3 User Properties
- 4 Assigned Policies
- 5 Apps
- 6 Actions
- 7 Delivery Groups
- 8 Certificates
- 9 Connections
- 10 TouchDown

+ Screen Add

+ Security information Add

+ Storage space Add

+ System information Add

- XenMobile Agent Add

Amazon MDM API available	False
HTC MDM API available	False
NitroDesk TouchDown installed	False
Samsung KNOX API available	False
Samsung KNOX API version	1.0
Samsung SAFE API available	True
Samsung SAFE API version	4
Sony Enterprise API available	False
XenMobile agent ID	com.zenprise
XenMobile agent revision	378981
XenMobile agent version	10.3.10

- The **Troubleshooting and Support** page has been rearranged to improve usability.

XenMobile Analyze Manage Configure ⚙️ 🔍 administrator ▾

Troubleshooting and Support

Diagnostics

- NetScaler Gateway Connectivity Checks
- XenMobile Connectivity Checks

Log Operations

- Logs
- Log Settings

Support Bundle

- Create Support Bundles

Advanced

- Cluster Information
- Garbage Collection
- Java Memory Properties
- Macros
- PKI Configuration
- Anonymization and De-anonymization

Links

- Citrix Product Documentation
- Citrix Knowledge Center

Tools

- APNs Signing Utility
- Citrix Insight Services
- Device NetScaler Connector Status

- **Log messages.** Log messages generated when a user can't be found now include the possible reasons. For example: Invalid credentials, LDAP configuration, or user missing from the LDAP domain or user base DN.
- **List pagination.** Lists on **Manage > Devices**, **Manage > Enrollment Invitations**, **Manage > Users**, **Configure > Device Policies**, **Configure > Apps**, **Configure > Actions**, **Configure > Enrollment Profiles**, and **Configure > Delivery Groups** are now paginated. You can choose the number of items to show on a page.

<input type="checkbox"/>		Microsoft OneDrive - CS	Public App Store	Default	11/15/16 2:30 AM	11/15/16 2:30 AM
<input type="checkbox"/>		Microsoft PowerPoint - CS	Public App Store	Default	11/15/16 2:30 AM	11/15/16 2:30 AM
<input type="checkbox"/>		GoToMeeting - CS	Public App Store	Default	11/15/16 2:30 AM	11/15/16 2:30 AM

Showing 76 - 96 of 96 items Items per page: 25 ▲ Page 4 of 4 < >

- **New REST API parameter to support remove license servers.** The license REST API now has a new parameter, **serverPort**, to support remote license servers. For the full REST API reference, see [this PDF](#). In addition, the documentation for the license API is updated. The documentation includes the license server and license notification response information for Save License Info. The documentation also includes other corrections.
- **Additions to the XenMobile Public API for REST Services.** The REST API now sends all device properties in a device call that uses a filter. The API wraps device properties in a JSON object and includes the properties as part of the response.

The REST API now includes calls for ShareFile Enterprise, ShareFile StorageZones, and ShareFile StorageZone Connectors.

For more information, see the [XenMobile Public API for REST Services PDF](#).

Deprecated items

Windows 8.1 tablets are no longer supported. XenMobile Server no longer supports Windows 8.1 tablets.

Device policies for Windows 8.1 tablets are removed. The Sideload key and Signing certificate device policies are deprecated.

Known issues in version 10.5

With NetScaler 12.0.41.16, when Secure Mail is configured with STA, mail sync fails on iOS and Android devices. The issue is fixed in NetScaler 12.0 build 41.22. For details and updates, see this [Support Knowledge Center](#) article. [#685075]

When you integrate StoreFront with XenMobile and deploy HDX apps, after you change an Active Directory password, the HDX apps disappear from the XenMobile Store. [CXM-9859]

After you upgrade to XenMobile 10.4.2, Android for Work apps don't appear on the device for a user in a nested Active Directory group. [CXM-19930]

An upgrade from XenMobile 10.3.6 to XenMobile 10.5 might change the device owner to "anonymous" for enrolled devices running Android for Work. [CXM-19933]

Users can renew certificates even if **Renew certificates when they expire** is **OFF** in your XenMobile configuration. [CXM-

20923]

For Active Directory users in a group with permissions for StorageZone Connectors: If you move users out of the group, ShareFile for iOS users can still access Network shares associated with those connectors. To work around this issue, reinstall the ShareFile for iOS app. [CXM-21859]

If you move a StorageZone Connector from delivery group A to B, ShareFile for iOS users in delivery group A can continue to use the connector. [CXM-21860]

If XenMobile uses self-signed certificates, users can't enroll iOS 10.3 devices into XenMobile. This limitation results from a change in iOS 10.3. To enroll devices running iOS 10.3 or later into XenMobile, you must use trusted SSL certificates in XenMobile. [CXM-24120]

When deploying apps, a prompt tells users to install the app if it is already installed on the device but has never been opened. As part of a fix for this issue, if an app is updated on the server, it is not updated on the user's device until they launch the app. [CXM-32193]

Upgrade Tool known issues

After you upgrade to XenMobile 10.4 from XenMobile 9, some policies for Windows devices appear in the XenMobile console, even after XenMobile deploys them. Specifically, the policies remain on the **Pending** tab of the **Assigned Policies** page of **Manage > Devices**. As a workaround, edit and then redeploy any policies shown as pending. That action clears the policies for Windows phones from the **Pending** tab. The Webclip policy for Windows tablets remains on the **Pending** tab although it works properly on the devices. [CXM-21769]

Fixed issues in version 10.5

XenMobile 10.5 includes the following fixed issues. Fixed issues for the Upgrade Tool appear in XenMobile Upgrade Tool in this article.

For iPhone6 devices, when users try to enroll devices using one-time password invitations that are bound to the device IMEI/MEID, the first profile installs successfully. The second MDM profile installation fails with the error message, "Profile Installation Fails. A connection to the server could not be established." On iPhone devices, the one-time password binds to the MEID number instead of the IMEI number. [#606162]

You cannot locate your Android ID by typing *****#8255#***** on your phone, as instructed on the **Settings > Google Play Credentials** page. Use a device ID app from the Google Play store to look up your device ID. [#633854]

After upgrading to XenMobile Server 10.4:

- If you open a **ShareFile** tab, the page might not load and the information does not appear.
- If you attempt to add or edit a delivery group, the following error message might appear: 500 Internal Server error. [663344, 663788, CXM-19085]

After using the MDX Toolkit to wrap an app that was developed using the Mowbly framework, the app navigation buttons no longer work. [#654962]

Accessing aggregated HDX apps in Secure Hub might fail with the error message, Failed to get application detail, please try again later. [#658058]

When Citrix Launcher is deployed to devices, apps don't appear under background tasks. [#680978]

If the web proxy JSON file for App Controller 9.0 includes an unescaped backslash character in the web proxy user name, XenMobile Server can't start. [CXM-13721]

In clustered XenMobile deployments managed by Hazelcast, a node in the cluster might intermittently fail to appear in the Hazelcast member list. [CXM-16537]

If you configure an IPsec VPN device policy, the group name and shared secret isn't saved and is missing on the device. [CXM-17002]

After an upgrade to 10.3.6, devices with multiple valid identities can't renew. If there are many renewal failures, XenMobile might crash repeatedly. [CXM-17358]

An issue might occur with an intermediate CA certificate used for client certificate authentication. The issue causes a network access error to appear on Android devices. [CXM-17401]

Issues might occur with SQL database configuration when updating XenMobile from version 10.3.5 to 10.3.6. [CXM-17565]

The on-premises version of XenMobile periodically synchronizes the license server with licenses that XenMobile checked out. The synchronization ensures that the count matches the number of devices and users. In this way, if XenMobile detects a mismatch, the issue is resolved within 24 hours. [CXM-18129]

The XenMobile console requires that you specify a password for the WiFi policy, although a password is optional. [CXM-18249]

XenMobile isn't deploying user profiles because the date format has the wrong format. [CXM-18250]

If using the XenMobile console with an Internet Explorer 11 browser, you cannot add or edit an LDAP configuration. [CXM-18324]

If you create an Exchange policy for all device types, and the policy includes a macro for the domain **\$user.dnsroot**, the policy doesn't deploy. [CXM-18545]

If a delivery group name includes an ampersand (&), assigning a policy to that delivery group results in an error. [CXM-18768]

After configuring DEP settings for the first time in **Settings > iOS Bulk Enrollment**, this error appears when you click **Save: Resources bag** (container) with name 'Worx Home by Citrix' doesn't exist. To work around this issue, create a delivery group (**Configure > Delivery Groups**) after you configure the DEP settings and click **OK** on the error page. The delivery group must include the following:

- The user group named **Device Enrollment Program Group**
- The policy **DEP Software Inventory**
- The required app **Secure Hub by Citrix**

This issue doesn't affect existing enrollments if DEP was configured before Citrix Secure Hub appeared in the Apple Store on October 6, 2016. [CXM-19158]

For Enrollment Invitation or Enrollment PIN templates: If the message in a template includes certain macros, the message sent to users includes the macro instead of the user information. Those macros are enrollment URL (`${enrollment.url}`) and enrollment PIN (`${enrollment.pin}`). [CXM-19210]

Sometimes you can't upload an Enterprise app because XenMobile is unable to find the application icon although the icon is available. [CXM-19213]

In the **Settings > PKI Entities > Discretionary CA** page, you can view only the first page of CA certificates if there are multiple pages of certificates. [CXM-19736]

For a delivery group deployed to multiple devices: If you click a delivery group on **Configure > Delivery Groups**, and then click a button under **Deployment**, the **Manage > Devices** page shows an incorrect device list. [CXM-19737]

If a XenMobile App update is available in the iOS App Store or the Google Play Store: Prompts for app updates don't appear in the XenMobile Store after a user opens the app. [CXM-19927]

A XenMobile macro that includes \$user.dnsroot does not resolve for domains where the parent and child domains are in a tree-root trust relationship. [CXM-20366]

If the sAMAccountName differs from the name portion of the UPN, macro resolution for the client property SEND_LDAP_ATTRIBUTES fails. For example: The sAMAccountName is **samplename** and the UPN is **sample@example.com**. [CXM-20414]

If XenMobile is in MDM mode and you're using DEP enrollment with user credentials supplied during the DEP phase: If a user removes Secure Hub from the device within a short interval after enrollment, the server gets into an inconsistent state. A short interval might be one hour. [CXM-20924]

A device doesn't automatically go into compliance after an automated action. [CXM-21006]

For RBAC administrators in a custom RBAC role that includes some user group restrictions: If Active Directory users in user groups have some devices enrolled, the **Manage > Devices** page opens slowly. [CXM-21007, CXM-21009]

After upgrading to XenMobile 10.3.6, administrators with custom RBAC role access can see enrolled devices from other domains even if the RBAC configuration restricts that access. [CXM-21008]

XenMobile cluster members might not respond to some HTTP requests, which prevents users from enrolling because of the **Company network not available** errors. [CXM-21010]

If the iOS bulk enrollment settings have **Require credentials for device enrollment** enabled, any type of invitation for a DEP enrollment causes XenMobile Server errors. The errors include error messages in Secure Hub, error messages in the XenMobile console, and loss of MDM functionality for all devices. To work around this issue, delete all enrollment invitations for the affected users on the **Manage > Enrollment** page. Then, restart the XenMobile Server. [CXM-21500]

Automatic actions that the XenMobile Lost Mode triggers fail for iOS devices configured with a passcode. This issue applies to all available actions triggered by Lost Mode: **App wipe**, **App lock**, **Mark the device as out of compliance**, and **Send notification**. [CXM-21579]

The Devices & Apps report generated from **Analyze > Reporting** shows an incorrect app install count for each device. [CXM-21773]

When you add the Skype for Business public app on XenMobile Console, the icon might not appear. However, you can search and add the app on the console and the app can be installed on the device. [CXM-21774, #668341]

Some Enterprise apps for Android don't upload to a XenMobile console configured in MDM or XME mode. [CXM-22377]

Deploying resources based on dynamic device properties, such as Current mobile country code, don't work. XenMobile ignores the rules and allows the resources (such as device policies, apps, and actions) to deploy on the device. [CXM-22565]

You can't create a support bundle by using the XenMobile CLI. As a workaround, use the XenMobile console: Go to **Support**

> **Create Support Bundles** and then click **Create**. [CXM-23091]

After an upgrade to XenMobile 10.3.6, Secure Hub no longer includes HDX apps. Logs include the entry, Unable to get the Config xml data Host name. [CXM-23177]

If you edit only the platform details for a device policy: The edits don't trigger a change to the **Last updated on** time on **Configure > Device Policies**. The last update time does change after you add or remove platforms. [CXM-23178]

If your browser language is set to French, you can't create or edit the WiFi device policy in the XenMobile console. [CXM-23180]

The **Manage > Devices** page shows iOS devices as inactive although the devices are active and communicating with XenMobile Server. This issue appears in logs as follows:

```
java.lang.IllegalStateException: Cannot load backing target entity: has been deleted. [CXM-23181]
```

If the server property **StorageZone Connectors supported value** is **NOT SUPPORTED** and you configure ShareFile: After you navigate to a different console page and then return to **Configure > ShareFile**, the **ShareFile** page doesn't show the configuration although the configuration is saved. To work around this issue, change the server property, **ShareFile configuration type**, to **ENTERPRISE**. [CXM-23337]

When a DEP device is deleted and then re-enrolled, the re-enrollment might fail with the error, Invalid profile. [CXM-24078]

This release contains a defense-in-depth measure for CVE-2016-5195, also known as Linux Dirty Cow.

Upgrade Tool fixed issues

If your deployment in XenMobile 9 includes a gpsstats.apk enterprise app, the upgrade to XenMobile 10.4 might fail. [CXM-17992]

After an upgrade from XenMobile 9 to XenMobile 10.4, Windows and iOS devices are in MDM mode instead of in MAM+MDM mode. In addition, the XenMobile Store does not open. As a workaround, users can reenroll a migrated device. [CXM-18532, CXM-23408]

After an upgrade from XenMobile 9 to XenMobile 10.4, XenMobile has duplicate, inactive MAM-only records from prior re-enrollments. That issue occurs even if XenMobile 9 required Device Manager enrollment. [CXM-18544]

During an upgrade from XenMobile 9.0 to XenMobile 10.4.x: The Upgrade tool doesn't update the device name in the device property table for devices that are enrolled in XME (MDM+MAM) mode. [CXM-20821]

If the App Controller database contains users in the data format **username**, an upgrade from XenMobile 9.0 to XenMobile 10.x fails. Instead, use the data format **domain\username** or **username@domain**. [CXM-21072]

If the case of the path to the .p12 server certificates differs for HTTP and HTTPS, an upgrade from XenMobile 9.0 to XenMobile 10.4.x fails. For example, if the HTTP path is Certificates\MDM.p12 and the HTTPS path is certificates\MDM.p12. [CXM-21581]

After an upgrade from XenMobile 9 to 10.x, XenMobile Store doesn't include apps. Also, XenMobile doesn't assign local groups to delivery groups. This issue occurs if a local user is part of a local group and the local user enrolls the device. [CXM-23375]

If Device Manager has two records for an Active Directory user and those records don't match as follows, an upgrade fails:

- The records have different UPNs. For example, one user record has a UPN of john.smith@eng.domain.com. The other record has john.smith@domain.com.
- The records have case differences in the sAMAccountName. For example, one user record has a sAMAccountName of johns. The other record has JOHNS. [CXM-23382]

After an upgrade from XenMobile 9 to XenMobile 10.x: You cannot edit in the upgraded XenMobile console a configuration policy that you customized in Device Manager by using the iPhone Configuration Utility or Apple Configurator. [CXM-23942]

What's new in XenMobile Server 10.4

Jul 11, 2017

Note

For the full set of product documentation for XenMobile Server 10.4, see the [PDF](#).

XenMobile Server 10.4 includes the following new features. For information about known and fixed issues, see [Known issues](#) and [Fixed issues](#) later in this article.

Worx Mobile Apps are now XenMobile Apps

As of the release of version 10.4, Worx Mobile Apps are renamed to XenMobile Apps. Most of the individual XenMobile Apps are renamed as well. Worx Home has been renamed Secure Hub, and Citrix-developed apps are Secure Mail, Secure Forms, Secure Web, Secure Tasks, and Secure Notes. The changes are reflected in the user interfaces of all the apps, as well as the MDX Toolkit and the XenMobile console. For more information about the new product names, see [About XenMobile Apps](#).

Distribute XenMobile Apps from public app stores

Beginning with the 10.4.1 release of XenMobile Apps, you can distribute XenMobile Apps from the Apple App Store and Google Play Store. Although Secure Hub was already available on public app stores, this release extends that capability to all XenMobile Apps. Public app store apps require a fresh installation the first time you deploy them. It is not possible to upgrade from the current enterprise wrapped version of the app to the public store version.

Citrix will support both enterprise distribution and public app store distribution for one year from the first release; that is, until October 31, 2017. After that, only public app store distribution will be supported.

With public app store distribution, you no longer have to sign and wrap the apps with the MDX Toolkit. This significantly streamlines the process of deploying apps. Since the XenMobile server already supports deploying apps from the public app store, no server update is required. You can still use the MDX Toolkit to wrap third-party or enterprise apps.

For details, see [Public App Store Delivery of XenMobile Apps](#) in the XenMobile Apps documentation.

App configuration policy for Windows 10 devices

You can now use the App Configuration policy to specify app setting key/value pairs for managed apps deployed to Windows 10 phone, desktop, and tablet devices.

To add the device policy, go to **Configure > Device Policies**, click **Add**, and in the **Add a New Policy** dialog box, start typing **App configuration**.

Improved status information provided for licenses and certificates

Each time you log on to or refresh the XenMobile console, the dialog box that displays license and certificate status will now include the following information: Expiration information for all types of certificates, including Certificate Authority, CSR, entity, chain, SAML, APNs, Listener, and device CA.

To help you identify the certificates listed, the certificate name is included with the expiration warning. Expiration information for a certificate appears only if the logged on user has permission for the certificate type.

The dialog box shows both licenses and certificates only if they are both nearing expiration. Included are local and remote licenses that are within 60 days of expiration, trial licenses that are within 15 days of expiration, and certificates that are within 30 days of expiration.

License and Certificate Expiration Warning ×

The following licenses and certificates are nearing expiration. Upload new licenses or certificates to prevent interruptions for your end-users.

Licenses

- 🕒 XenMobile Advanced license 3 days left

Certificates

- ⚠️ XMS.example.com (SAML) **Expired 2 days ago**
- 🕒 cacert.pem (Devices CA) 3 days left
- 🕒 APSP-2623302e-74hd-3456f-3456-567-38f886 (APNs) 3 days left
- 🕒 ebricks-inc.net (SSL Listener) 3 days left

Dismiss
Go to Settings

In addition, the **Certificates** page now includes a **Status** column, which indicates whether a certificate is about to expire, has expired, or is up to date.

XenMobile
Analyze
Manage
Configure
⚙️
👤 admin ▾

Settings > Certificates

Certificates

You must restart XenMobile on all nodes to commit and activate your changes to the SSL and Android for Work SAML certificates. To restart XenMobile, use the hypervisor console or command-line window.

📁 Import
➕ Add

	Name	Description	Status	Valid from	Valid to	Type	Private key	
<input type="checkbox"/>	XMS.example.com	Self Signed/Generated	Up to date	2015-11-16	2025-11-13	SAML	✓	
<input type="checkbox"/>	*.agsag.com		⚠️ Expired	2013-10-23	2015-10-23	SSL Listener	✓	
<input type="checkbox"/>	cacerts.pem	Self Signed/Generated	Up to date	2015-11-16	2035-11-14	Devices CA		
<input type="checkbox"/>	ent-root-ca		Up to date	2012-02-22	2017-02-21	Root or intermediate		
<input type="checkbox"/>	APSP:3623302e-7c6e-4df8-aa91		🕒 22 days left	2015-09-30	2016-09-29	APNs	✓	

Showing 1 - 5 of 5 items

Citrix Launcher configuration

Citrix Launcher lets you customize the user experience for Android devices deployed by XenMobile. Citrix Launcher is an Enterprise app, provided on the Citrix.com downloads page for XenMobile. The file name is CitrixLauncher.apk.

You can add a Launcher Configuration policy to control these Citrix Launcher features:

- Manage Android devices so that users can access only the apps that you specify.
- Optionally specify a custom logo image for the Citrix Launcher icon and a custom background image for Citrix Launcher.
- Specify a password that users must enter to exit the launcher.

While Citrix Launcher enables you to apply those device-level restrictions, the launcher grants users the operational flexibility they need through built-in access to device settings, such as WiFi settings, Bluetooth settings, and device passcode settings. Citrix Launcher isn't intended as an extra layer of security over what the device platform already provides.

To add the device policy, Launcher Configuration Policy, go to **Configure > Device Policies**, click **Add**, and in the **Add a New Policy** dialog box, start typing **Launcher**.

The screenshot shows the XenMobile configuration interface. The top navigation bar includes 'XenMobile', 'Analyze', 'Manage', and 'Configure'. Below this, there are tabs for 'Device Policies', 'Apps', 'Actions', 'ShareFile', 'Enrollment Profiles', and 'Delivery Groups'. The main content area is titled 'Launcher Configuration Policy' and is divided into three sections: '1 Policy Info', '2 Platforms', and '3 Assignment'. The '2 Platforms' section is expanded to show 'Android' selected. The 'Policy Information' section contains the following fields:

- Launcher app configuration**
 - Define a logo image**: ON. Logo image: ribbon.png. **Browse**
 - Define a background image**: ON. Background image: . **Browse**
- Allowed apps**

App name	Package Name*	Add
test	test.com	<input type="button" value="Add"/>
- Password**:

At the bottom, there is a 'Deployment Rules' section and 'Back' and 'Next >' buttons.

For information about adding and deploying Citrix Launcher, see [Citrix Launcher](#).

More user name information in Devices and Users pages

The User name column in **Manage > Devices** includes first and last name, in addition to email address. The **Manage > Users** page includes the columns **First name** and **Last name**.

Devices [Show filter](#)

- Add
- Import
- Export
- Refresh

<input type="checkbox"/>	Status	Mode	User name	Device platform	Operating system version
<input type="checkbox"/>		MDM MAM	us1user1@...net "us1 user1"	Android	5.0.2
<input type="checkbox"/>		MDM MAM	us3user3@...net "us3 user3"	iOS	8.4.1

Users [Show filter](#)

- Add Local User
- Import Local Users
- Manage Local Groups
- Export

<input type="checkbox"/>	User name	First name	Last name	Roles	Groups
<input type="checkbox"/>	us1user1@...net	us1	user1	USER	...net\Domain Users
<input type="checkbox"/>	us3user3@...net	us3	user3	USER	...net\Domain Users

Improved Settings page layout

The **Settings** page now includes a list of frequently accessed settings. The default list gets replaced with your most frequently accessed settings as you work. The **Settings** page is also rearranged, for easier scanning.

Settings**Certificate Management**[Certificates](#)[Credential Providers](#)[PKI Entities](#)**Client**[Client Branding](#)[Client Properties](#)[Client Support](#)**Notifications**[Carrier SMS Gateway](#)[Notification Server](#)[Notification Templates](#)**Platforms**[Android for Work](#)[Google Play Credentials](#)[iOS Bulk Enrollment](#)[iOS Settings](#)[Samsung KNOX](#)**Server**[ActiveSync Gateway](#)[Enrollment](#)[LDAP](#)[Licensing](#)[Local Users and Groups](#)[Mobile Service Provider](#)[NetScaler Gateway](#)[Network Access Control](#)[Release Management](#)[Role-Based Access Control](#)[Server Properties](#)[SysLog](#)[Workflows](#)[XenApp/XenDesktop](#)**Frequently Accessed**[Certificates](#)[Enrollment](#)[Licensing](#)[Local Users and Groups](#)[Role-Based Access Control](#)[Release Management](#)**Automatic Enrollment in Secure Mail**

For MAM-only deployments, you can configure XenMobile so that users with Android or iOS devices who enroll in Secure Hub with email credentials are automatically enrolled in Secure Mail. This means users do not have to enter additional information or take additional steps to enroll in Secure Mail.

On first-time use of Secure Mail, Secure Mail obtains the user's email address, domain, and user ID from Secure Hub. Secure Mail uses the email address for autodiscovery. The Exchange server is identified using the domain and user ID, which enables Secure Mail to authenticate the user automatically. The user is prompted to enter a password if the policy is set to not pass through the password, but the user is not required to enter any additional information.

To enable this feature, you create a server property and two client properties.

Edit New Server Property

Key	<input type="text" value="MAM_MACRO_SUPPORT"/>
Value*	<input type="text" value="true"/>
Display name*	<input type="text" value="MAM_MACRO_SUPPORT"/>
Description	<input type="text" value="MAM_MACRO_SUPPORT"/>

Add New Client Property

Key	<input type="text" value="Custom Key"/> ?
Key*	<input type="text" value="ENABLE_CREDENTIAL_STORE"/>
Value*	<input type="text" value="true"/>
Name*	<input type="text" value="Enable credential store"/>
Description*	<input type="text"/>

Add New Client Property

Key	Custom Key ?
Key*	SEND_LDAP_ATTRIBUTES
Value*	userPrincipalName=\${user.userprincipalname},sAM
Name*	SEND_LDAP_ATTRIBUTES
Description*	SEND_LDAP_ATTRIBUTES

Report for Blacklisted Apps by Device and User

XenMobile now provides a pre-defined report that lists blacklisted apps that users have on their devices. It is available on the **Analyze > Reporting** tab of the XenMobile console and is called Blacklisted Apps by Device & User.

The screenshot shows the XenMobile console interface with the 'Reporting' tab selected. The navigation bar includes 'XenMobile', 'Analyze', 'Manage', and 'Configure'. The main content area displays several report cards:

- Top 10 Apps - Failed Deployment:** List of apps that have failed deployment. Report Data: app name, # of deployments, deployment status, type, category, deployment date, app owner.
- Inactive Devices:** List of devices that have been inactive for a specified length of time. Report Data: last activity, device mode, platform, version, user name, last authentication, device IMEI, serial number, model, first connection.
- Apps by Type & Category:** List of apps and app versions by app type (MDX, Public, Web & SaaS, Enterprise, Web Link) and defined categories. Report Data: app name, version, # of deployments, deployment status, type, category, deployment date, app owner.
- Device Enrollment:** List of devices that have been enrolled during a specified length of time. Report Data: first connection, device mode, platform, version, model, user name, last authentication, phone number.
- Apps by Platform:** List of apps and app versions installed on various device platforms and device versions. Report Data: app name, version, # of deployments, deployment status, deployment date, app owner, device platform, version, model, model name.
- Devices & Apps:** List of all devices, device data, and apps installed. Report Data: device serial number, user name, ID, email, device platform, version, model, mode, status, last connection, enrollment status, enrollment date, device ownership, location, certificate expiration, app name, version, deployment status, type, category, deployment date, app owner, app ID.
- Blacklisted Apps by Devices & User:** List of blacklisted apps that users have on their devices. Report Data: app name, app owner, app size, app version, app id, app install time, user name, user id, email, device serial number, platform, model name, OS version, device ownership, device mode, device status.

Additions to the XenMobile Public API for REST Services

You can now use the REST API to:

- Use a delivery group ID to get, edit, delete, enable or disable, deploy, or get the status of a delivery group.
- Provide the last location even when a device is offline.
- Add or edit a user property
- Assign a user to a local group

For more information, see the [XenMobile Public API for REST Services PDF](#).

Known issues in version 10.4

When you configure Citrix Launcher, the **Just Once** option does not work. You must click the **Always** option. [CXM-13413]

Occasionally, when users reenroll an Android device, a selective wipe occurs unexpectedly. [CXM-13716]

When you configured public apps in the XenMobile console, after updating to XenMobile 10.4, when you deploy Secure Hub to a Windows 10 tablet, users cannot view the public apps. [CXM-16516]

With Citrix Launcher, in MDM mode, when users open the XenMobile Store, the store opens in a default browser even if you listed a different browser on a white list. [CXM-17097]

Citrix Launcher can't download logo and background images from a server that has a self-signed certificate. [CXM-17159]

When using the XenMobile console with an Internet Explore 11 browser, you cannot add a new LDAP configuration. [CXM-18324]

Upgrade Tool 10.4 known issues

Data and policy issues

After upgrading, syslog server configuration data is not migrated to the XenMobile server. [#558539]

Some Restriction policy configurations were deprecated in 10.1. Therefore, XenMobile 10.4 fails to deploy the entire Restriction policy successfully to Windows 10 phones after you upgrade from XenMobile 9 to XenMobile 10.4. If you view and save the policy settings in XenMobile 10.4, however, the policy deploys successfully. [#608541]

If your deployment in XenMobile 9 includes a gpsstats.apk enterprise app, the upgrade to XenMobile 10.4 may fail. [CXM-17992]

After you upgrade to XenMobile 10.4 from XenMobile 9, Windows devices are in MDM mode instead of in MAM+MDM mode; in addition, the XenMobile Store does not open. As a work around, users can reenroll a migrated device. [CXM-18532]

Google Play apps

If you include a public Google Play app for Android devices with a default icon, after migrating, the default icon does not appear in the XenMobile console. You must either edit and save the app or click Check for Updates in order for the image to appear. [#557996]

SQL Server

If you use a PostgreSQL database, MAM devices are unable to re-enroll after an upgrade. To work around this issue, delete the device entries from XenMobile and send enrollment notifications to the users. [#632831]

RBAC

Issues with RBAC settings occur after upgrading:

- If you have configured a super administrator role, all permissions are selected by default. After upgrading, only three permissions are selected - RBAC, Enrollment, and Release Management.
- If you have created a custom super administrator role, all support permissions should be selected by default. After upgrading, none of the support permission settings is selected. To work around this issue, create the support permission

after upgrading. [#569350, #569395, #569423]

Citrix Secure Hub and Citrix Store

Before upgrading from XenMobile 9 to XenMobile 10.4, if your WorxStore has a custom name, issues occur with enrollment, access to Worx Home and access to the Worx Store. As a workaround, change the store to the default setting of **Store** before upgrading. For details on the prerequisite workaround, see [Upgrade Tool prerequisites](#). [#619458]

Users with MAM-only devices are unable to authenticate to Citrix Secure Hub after an upgrade from XenMobile 9.0 to XenMobile 10.4 followed by setting the LDAP option **User search by** to **sAMAccountName**. [#628233]

Android for Work

After an upgrade, SAML login for Android for Work fails because the SAML certificate has a .pem extension, which the XenMobile server won't import. [#631795]

To work around this issue, make sure XenMobile has the correct SAML certificate, as follows:

1. Export from XenMobile 9 App Controller the SAML certificate with a private key ([AppController.example.com](#)). That certificate is in PEM format and has a .pem extension.

2. Use the openssl command to generate a PFX file from the PEM file:

```
openssl pkcs12 -export -out certificate.pfx -in certificate.pem
```

3. Imported the PFX file into XenMobile 10.3 as a SAML keystore.

4. Export the SAML certificate without the private key from XenMobile 10.4 and then upload it to Android for Work domain.

Fixed issues in version 10.4

When you try to add a public app store app for Windows Phone, when you enter a URL from the Microsoft store, the upload fails. [CXM-13468]

For some configurations, after upgrading from XenMobile 9 to 10.3.6, devices that were previously enrolled in XenMobile 9 cannot open installed apps or download new apps from the WorxStore. Apps also disappear from Worx Home and users can't access the WorxStore. [CXM-13708]

When you create a WiFi device policy with a defined WiFi password that includes special characters, such as a less than symbol (<), greater than symbol (>) or an ampersand (&), users are prompted to enter their WiFi password. [CXM-13717]

When you try to upload an iOS enterprise app, an "icon not found" error appears when the icon size exceeds 1,000 KB. [CXM-13729]

If clustering is enabled and a device wipe is sent to a disconnected device, the device is wiped when it reconnects, as expected. However, if the device re-enrolls or connects to a different cluster node, XenMobile wipes the device again. [CXM-13793]

The shared devices enroller permission is enabled by default for the Admin RBAC role in XenMobile Service (cloud) deployments. As a result, all devices belonging to users with the Admin role enroll as shared devices. [CXM-15203]

When you configure client certificate authentication and the Require Server Name Indication option is enabled on the CA

server, enrollment fails. [CXM-15312]

When searching for Google Play Store apps from the XenMobile console, the search does not return apps based on the Android operating system on the registered device. For examples, apps that require a minimum operating system of 4.4 do not appear in the results. [CXM-15653]

When you create a local user assigned to a local group and when the local user tries to enroll using a Windows 10 device, enrollment fails. [CXM-16895]

When you create a Citrix Launcher policy, users can enroll an Android device, but if you change a policy setting, they cannot exit Citrix with the password you set in the policy. As a workaround, you need to reinsert the password in the policy settings and update the policy. [CXM-17157]

When you disable the Enable ShareFile option in XenMobile, in Secure Mail for Android, users cannot access any attachment type. [CXM-17887]

When you update from XenMobile 10.3.6 with Rolling Patch 1 to XenMobile 10.4, license types of permanent expire with an error message. [CXM-17900]

When you update from XenMobile 10.3.6 to XenMobile 10.4, even though the license of permanent type is still valid, an expired license error message appears. [CXM-17987]

If you manually enter a URL for a Windows public store app and the URL is not from a U.S. store, the XenMobile console displays an error. When you use the U.S. store app URL, the upload is successful. [CXM-18013]

When users receive one-time password invitations for IMEI binding (username and password) and SMTP and SMS notifications, the first profile installs successfully and the second profile installation fails with the error message "Profile Installation Fails. A connection to the server could not be established." On iPhone 6 and iPhone 6 Plus devices, there is an IMEI number and MEID number and the one-time password binds to the MEID number instead of the IMEI number. You can replace the IMEI number with the iPhone's Unique Device Identifier (UDID) or use a regular phone number. [#606162]

Attempts to download a Certificate Signing Request (CSR) from Internet Explorer and Firefox web browsers fail with the error "The Webpage cannot be displayed." Downloading the CSR from the Chrome web browser works. [#609552]

If you log on to the XenMobile console, navigate to **Analyze > Reporting** and then click **Inactive Devices**, a blank page appears instead of downloading the file. [#609649]

The XenMobile NetScaler Connector doesn't obtain the Samsung 5.x devices from a sync with ActiveSync. [#613522]

When you create a WiFi device policy for Android with an authentication type of 802.1x EAP, the Password field is no longer mandatory. [#614932]

This fix addresses a security vulnerability. For more information, see security bulletin in <http://support.citrix.com/article/CTX207824>.

Note: For this security fix to work, a second reboot of the XenMobile server is required for the fix to take effect. [#624347]

You cannot currently locate your Android ID by entering *##8255##* on your phone, as instructed on the XenMobile **Settings > Google Play Credentials** page. Use a device ID app from the Google Play store to look up your device ID. [#633854]

Windows Phone enrollment sometimes fails to start Worx Home. [#633884]

Disabled HDX apps do not enumerate in the Worx Store. [#634110]

The XenMobile server shows incorrect user data in the log file. [#636754]

After updating from XenMobile 10.3.1 to 10.3.6, the file type and destination folder in the Files policy properties doesn't display correctly in the XenMobile console. [#640334]

VPP token max length text box is 256 characters. [#640692]

Windows Phone users can't enroll a device with a sAMAccount. [#640847]

After removing enrolled users from the ShareFile control subsystem, the enrolled users might appear in the user audit log file of the XenMobile console. [#641342]

After upgrading from XenMobile Server 10.1 to 10.3.x, clicking <https://<enroll.FQDN>/zdm/enrollm.html>, the iOS platform is not listed as a platform selection. [#641771]

When you enroll a Worx Home for iOS device, the MDM enrollment might be successful but MAM registration fails. [#644892]

Deletion of nested groups is never reflected. [#647557]

If **Manage > Enrollment** has more than 2,000 entries, after you click **Export** the page goes blank and the report isn't generated. [#647855]

XenMobile administrators attempting to access the XenMobile console might be directed to the XenMobile Self-Help portal instead. This can happen when XenMobile administrator groups are created with role-based control access and a group is moved from one Active Directory OU to another. [#647987]

Uploading iOS app fails with error - Uploaded mobile app is invalid. Application icon was not found.[#649574]

XenMobile server might become unresponsive with an Out of Memory error. [#650490]

Device wipe issues because of clustered messaging. [#650555]

When configuring a VPN device policy, you can't specify a port number. [#650972]

After upgrading XenMobile server with clustering enabled, several deadlocks might occur. The server might become unresponsive. [#651122]

The XenMobile console doesn't include Serial Number details while prompting you to confirm device deletion. [#651185]

SSO Account Policy on XenMobile server 10.3.6 does not work as expected. Users keep getting prompted for password. [#651860]

Cannot disable iPad app association on XenMobile 10.3.6 for VPP applications.[#652280]

If you delete a delivery group from a device policy, XenMobile doesn't save the change and the delivery group remains assigned to the policy. [#652321]

SSO account unable to save short FQDN. [#652704]

When a user removes Device Admin rights from their Android device, XenMobile changes the state of both MDX and MAM enrolled devices to "Orange/unmanaged" and the user doesn't have access to any MDX apps. The MAM state should

remain as "Green/managed". [#655180]

Upgrade Tool 10.4 fixed issues

If the device setting in XenMobile 9.0 for maximum or minimum operating system is set to 10 or above and for excluded devices for MDX and enterprise apps, after upgrading, the rule does not migrate properly. Apps that should appear do not and apps that should not appear do. [#603412]

If Microsoft SQL server is configured as case-sensitive, an upgrade fails if the table "Id_Generator" is specified as "id_generator". [#623300]

After upgrading from XenMobile 9 to XenMobile 10, the Personal Hotspot policy value type is Boolean instead of string. [#633337]

If an Active Directory group name contains the "@" character, an upgrade fails. [#633718]

If your Device Manager 9.0 server is set up using Local PostgreSQL and you use localhost as a reference for the database server, an upgrade will fail. To work around this, edit ew-config.properties on the Device Manager 9.0 server and replace all localhost references with the IP address of the Device Manager database server, then continue with the Upgrade prerequisites. [#635023]

In XenMobile 9.0, when you define the **Users organizational unit** (OU) in the LDAP connection parameters, after you upgrade to XenMobile 10, the full root context is not appended to users organizational unit. For example, OU=MDMUsers, OU=SALES should be OU=MDMUsers, OU=SALES, DC=citrite, DC=com. As a result, you need to make the update manually in XenMobile 10. [#635981]

During an upgrade, when uploading the support bundle, the error "MAM set up failed, see the logs for details" appears and the Upgrade Tool retains corrupted MAM data. [#638062]

If an Active Directory group name contains the "." character, a role migrated as a delivery group loses its group association. [#647590]

If the web proxy setting in App Controller includes the "\" character, XenMobile 10.1 server can't start and the message "Starting main app..." appears as the server continues to reboot. [#647919]

After an upgrade from XenMobile 9 to XenMobile 10, paid VPP apps do not install from the XenMobile (Worx) Store unless the app configuration requires installation. [#668102]

In a cross-domain authentication configuration, after an upgrade to XenMobile 10.3.6, devices that were previously enrolled in XenMobile 9 can't open installed apps or download new apps from the Worx (XenMobile) Store or access the Store. [CXM-13708]

After an upgrade from XenMobile 9 to XenMobile 10, installed public store apps appear as unsubscribed in the XenMobile (Worx) Store. [CXM-17936]

If the database connection URL is localhost, you no longer must modify ew-config.properties.

If you have RBAC roles configured with access restricted to LDAP and Active Directory or any child, after upgrading, when you log on to the XenMobile console as an administrator, the same settings are not selected.

Fixed issues

Jun 19, 2017

XenMobile 10.6 includes the following fixed issues. Fixed issues for the Upgrade Tool appear in [XenMobile Upgrade Tool](#) in this article.

For fixed issues related to XenMobile Apps, see [Fixed issues](#).

When users enroll in XenMobile through an Azure Active Directory account, even after you wipe or revoke the device, they can enroll again without authorization. This issue is a third-party issue. [#628865, CXM-23203]

After upgrading to XenMobile Server 10.4:

- If you click the **ShareFile** tab, the page might not load and the information doesn't appear.
- If you attempt to add or edit a delivery group, the following error message might appear: 500 Internal Server error. [#663344, #663788, CXM-19085]

If a table of users or enrollment invitations has multiple pages and you edit an item on the second or following page: After you save the change, XenMobile shows the first page of the table and discards the updates. [CXM-20209]

If you move a StorageZone Connector from delivery group A to delivery group B: ShareFile for iOS users in delivery group A can continue to use the connector. [CXM-21860]

When you integrate StoreFront with XenMobile and deploy HDX apps: After you change an Active Directory password, the HDX apps disappear from the XenMobile Store. [CXM-9859, CXM-22821]

If a table of users or enrollment invitations spans multiple pages and you edit an item on the second or following page: After you save the change, XenMobile shows the first page of the table and discards the updates. [CXM-20209]

If you move Active Directory users out of a group with permissions for StorageZone Connectors, ShareFile for iOS users can still access associated Network shares. To work around this issue, reinstall the ShareFile for iOS app. [CXM-21859]

You can't create a support bundle by using the XenMobile CLI. As a workaround, use the XenMobile console: Go to **Support > Create Support Bundles** and then click **Create**. [CXM-23091]

For a multi-page table of devices in the XenMobile console: After you save an edit to an item on the second or following page, XenMobile shows the first page of the table and discards the updates. [CXM-23143]

App downloads for MAM deployments to iOS and Android devices might fail. [CXM-23280]

If the server property **StorageZone Connectors supported** value is **NOT SUPPORTED** and you configure ShareFile in the XenMobile console: After you navigate to a different page and then return to **Configure > Sharefile**, the Sharefile page doesn't show the configuration although the configuration is saved. To work around this issue, change the server property, **Sharefile configuration type**, to **ENTERPRISE**. [CXM-23337]

When you configure a Windows Information Protection device policy and you enable the setting **Revoke WIP certificate on unenroll**: After you selectively wipe a Windows 10 tablet account, users are able to access a secure file. In addition, the file is not encrypted as expected. This condition is an issue with Windows 10 RS1 tablet. [CXM-23362]

For devices connecting to a cluster node: When you deploy policies and apps from a different cluster node, cluster issues occur. [CXM-23737]

When users whose sAMAccountName is different from the UPN prefix in Active Directory try to enroll their devices by using the invitation URL: XenMobile attempts to resolve the sAMAccountName@domainname as UPN and enrollment fails. As a workaround, in the XenMobile console, create invitations by user instead of by group. [CXM-24223]

When XenMobile queries Active Directory for a user group and receives an empty response with no errors: XenMobile interprets the response to mean that the group is deleted from Active Directory. XenMobile then deletes the user group from its database, causing users to lose access. [CXM-24228]

The Syslog server does not show the app name for app downloads. [CXM-24620]

If you create an RBAC role name that includes an ampersand (&), the symbol is encoded and you cannot edit the name. [CXM-24621]

For a XenMobile Webclip device policy: If the name and URL includes HTML special characters, such as ampersand (&), XenMobile encodes the characters. As a result, the URL breaks when you deploy the policy to managed devices. [CXM-24622]

When adding a public Google Play Store app in the XenMobile console: The app search function doesn't pass through the proxy as expected and search fails to return the correct apps. [CXM-24894]

On the **Manage > Devices** page of the XenMobile console: Sorting by the **Inactivity Days** and **Last Access** columns in the table results in an error. [CXM-24895]

For Windows 10 devices enrolled through Azure Active Directory during initial setup of the device: You cannot perform a selective wipe on the device from the XenMobile console. This issue is a Microsoft limitation. [CXM-24899]

Issues might occur when uploading some VPP tokens to a new installation of XenMobile 10 or when migrating some VPP tokens from XenMobile 9 to 10.5. [CXM-25268]

If you include an ampersand (&) in a device policy or RBAC role name, XenMobile saves the name with **&** instead of **&**. For example, **policya&b** is named **policya&b**. [CXM-25630]

After you assign devices to a different DEP account, XenMobile removes those devices from its database. [CXM-25692]

In the **Configure > Device Policies** page for the VPN device policy, the following settings are optional, although the console page indicates that they are required (*): DNS server IP addresses, Search domains, Supplemental match domains. [CXM-25767]

If you add a VPP token to XenMobile, consume a VPP license with device association, delete the token, and then add the same token: In the **VPP ID Assignment** table on the **Configure > Apps** settings page, the **Associated Device** column might include **Hidden** instead of the device serial number. [CXM-25907]

All device properties for an enrolled macOS device get populated in XenMobile only if the following occurs: A delivery group is associated with the enrolled device and has a deployed resource, such as a policy. [CXM-25917]

After you click **Add** on the **Configure > Device Policies** page, XenMobile doesn't filter the policy list and search results by the selected platforms. Only the first five search results appear. [CXM-26354]

The General properties in the VMware console incorrectly show the Guest OS as a 32-bit OS, instead of 64-bit. This is resolved when the updated VMware (.ova) file is installed. [CXM-28048]

When users delete an app from the XenMobile console, the app remains in the database. As a result, the console doesn't

sync with the database. [CXM-29613]

When filtering a report by date on the **Analyze > Reporting** page, the Calendar under the last access doesn't open after you click the calendar icon. As a workaround, click the **Value** field to open the date chooser. [CXM-29748]

In the XenMobile console, when you edit a delivery group role, the delivery group name and **Next** button intermittently do not appear. [CXM-30010]

After you aggregate and deploy XenApp and XenDesktop resources to Secure Hub, with the associated configuration on the XenMobile console: The HDX app icons don't appear in the store and an error message appears when users launch the apps. The message is: XenApp - Failed to get application detail. Please try again later. [CXM-30737]

When you configure and save an automated action in the XenMobile 10.5 console, the Base or Advanced Deployment Rules are not saved. The issue occurs on all platforms. [CXM-30742]

In some XenMobile Server environments in a clustered configuration, memory allocation issues occur on all nodes. When this issue occurs, the servers become unresponsive. [CXM-31283]

Exporting a CSV file for the **VPP apps license usage** Dashboard widget results in high CPU utilization on the database server. [CXM-31917]

Occasionally, a memory spike and out of memory error occurs on a XenMobile Server instance. When this issue occurs, the XenMobile Server becomes unresponsive. [CXM-31959]

In the **Settings > Apple Configurator Device Enrollment** page, after you change a setting and then click **Save**, an Internal Server Error message appears. XenMobile saves the changes. [CXM-32446]

On the XenMobile **Settings > Google Play Credentials** page: After you type the settings and click **Save**, the message "Email or password incorrect" appears intermittently. This error is due to an update from Google. [CXM-32847]

XenMobile Upgrade Tool

After you upgrade to XenMobile 10.4 from XenMobile 9, Windows devices are in MDM mode instead of in MAM+MDM mode. In addition, the XenMobile Store does not open. As a work-around, users can reenroll a migrated device. [CXM-18532]

Issues might occur when uploading some VPP tokens to a new installation of XenMobile 10 or when migrating some VPP tokens from XenMobile 9 to 10.5. [CXM-25268]

After an upgrade from XenMobile 9 to 10.x, a certificate might not renew because of an issue with the certificate renewal period conversion. [CXM-25637]

If you use PostgreSQL with XenMobile 9: Upgrading from XenMobile 9 to 10.x might fail intermittently because the PostgreSQL JDBC driver ignored the fetch size. [CXM-25638]

Related information

[XenMobile Support Knowledge Center](#)

Known issues

Jun 19, 2017

XenMobile 10.6 includes the following known issues. Fixed issues for the Upgrade Tool appear under the heading "XenMobile Upgrade Tool" in this article.

For known issues related to XenMobile Apps, see [Known issues](#).

Some Enterprise apps for Android don't upload to a XenMobile console configured in MDM or Enterprise (XME) mode. [CXM-22377]

When you configure a Windows Information Protection device policy and you enable the setting **Revoke WIP certificate on unenroll**: After you selectively wipe a Windows 10 tablet account, users are able to access a secure file. In addition, the file is not encrypted as expected. This issue is a Microsoft issue with Windows 10 RS1 tablet. [CXM-23362]

For Windows 10 devices enrolled through Azure Active Directory during initial setup of the device: You cannot revoke the device from the XenMobile console. This issue is a Microsoft limitation. [CXM-24897]

After you update the obfuscated APK file for some Android apps in the XenMobile console: The older version appears in the details and the updated version doesn't deploy to devices. [CXM-25629]

For Windows 10 RS2 Phone: When you issue a Ring device action from **Manage > Devices**, the ring command fails and doesn't deploy to the device. This is a third-party issue. [CXM-25888]

For Windows 10 RS2 Phone and Tablet: During re-enrollment, a user isn't prompted for the Server URL. To work around this issue, restart the device. Or, on the email address screen, tap the **X** across from **Connecting to a service** to go to the **Server URL** page. This is a third-party issue. [CXM-25900]

When XenMobile is in MAM-only mode, enrollment fails after the following steps: [CXM-26481]

1. A user enrolls an iOS device through a one-time PIN invitation.
2. The user removes their account from Secure Hub.
3. The user re-enrolls through a different type of one-time PIN invitation. For example, the first enrollment mode is High Security and the second enrollment mode is Invitation URL + PIN. Enrollment occurs within the NetScaler Enable Session Reuse timeout value, which defaults to two minutes.

When derived credentials are enabled on XenMobile Server, the Self Help Portal allows you to create enrollment invitations for iOS. [CXM-29679]

For Windows 10 RS2 Phone: After a Custom XML policy or Restrictions policy that disables Internet Explorer deploys to the phone, the browser remains enabled. To work around this issue, restart the phone. This is a third-party issue. [CXM-30053]

On Windows 10 phones, if you deploy a Windows Information Protection device policy that has OneDrive configured as an allowed app, the following issue occurs. If you selectively wipe the device, OneDrive crashes when users open it. As a workaround, configure OneDrive as an exempt app in the Windows Information Protection device policy. [CXM-30618]

After XenMobile uses derived credentials for iOS device enrollment: If you later update **Settings > Derived Credentials** with a certificate that isn't from your provider, XenMobile continues to use derived credentials for iOS device enrollment. As a workaround, after you choose a different certificate in **Settings > Derived Credentials**, delete the derived credentials

certificate from **Settings > Certificates**. [CXM-31540]

On a Windows RS2 tablet device that is enrolled with the XenMobile Server and logged in to a deployed Exchange account: If you use the XenMobile console to make the device unmanaged (except full wipe), the Exchange account remains on the enrolled device. [CXM-31697]

If the deprecated Enterprise Data Protection policy is configured and you upgrade to the latest version of XenMobile, the XenMobile console displays this error: "A configuration error has occurred. Please try again." As a workaround, delete the EDP policy before you upgrade XenMobile Server. [CXM-32132]

When searching for an app in the Google Play Store from the XenMobile console, the message "Error logging in with Google Play credentials" appears intermittently. You can close the error message and continue to search for apps. [CXM-32441]

For XenMobile cloud deployments outside of the U.S. only: When searching for an app in the Public App Store from the XenMobile console, the message "Error searching app from store platform: windows_phone" appears. [CXM-32444]

In the German, Korean, and Simplified Chinese versions of the XenMobile console: On the Android platform page for the VPN device policy, for the Citrix VPN connection type, the following labels aren't translated.

- Password and Certificate (an Authentication type option)
- Application List, App Package Name [CXM-33640]

Related information

[XenMobile Support Knowledge Center](#)

Architecture

Jun 19, 2017

The XenMobile components in the XenMobile reference architecture you choose to deploy are based on the device or app management requirements of your organization. The components of XenMobile are modular and build on each other. For example, to give users in your organization remote access to mobile apps and to track user device types, you deploy XenMobile with NetScaler Gateway. XenMobile is where you manage apps and devices, and NetScaler Gateway enables users to connect to your network.

Deploying XenMobile components: You can deploy XenMobile to enable users to connect to resources in your internal network in the following ways:

- Connections to the internal network. If your users are remote, they can connect by using a VPN or micro VPN connection through NetScaler Gateway. That connection provides access to apps and desktops in the internal network.
- Device enrollment. Users can enroll mobile devices in XenMobile so you can manage the devices in the XenMobile console that connect to network resources.
- Web, SaaS, and mobile apps. Users can access their web, SaaS, and mobile apps from XenMobile through Secure Hub.
- Windows-based apps and virtual desktops. Users can connect with Citrix Receiver or a web browser to access Windows-based apps and virtual desktops from StoreFront or the Web Interface.

To achieve any of those capabilities for an on-premises XenMobile Server, Citrix recommends deploying XenMobile components in the following order:

- NetScaler Gateway. You can configure settings in NetScaler Gateway to enable communication with XenMobile, StoreFront, or the Web Interface by using the Quick Configuration wizard. Before using the Quick Configuration wizard in NetScaler Gateway, you must install one of the following components to set up communications: XenMobile, StoreFront, or the Web Interface.
- XenMobile. After you install XenMobile, you can configure policies and settings in the XenMobile console that allow users to enroll their mobile devices. You also can configure mobile, web, and SaaS apps. Mobile apps can include apps from the Apple App Store or Google Play. Users can also connect to mobile apps you wrap with the MDX Toolkit and upload to the console.
- MDX Toolkit. The MDX Toolkit can securely wrap mobile apps created within your organization or outside the company, such as XenMobile Apps. After you wrap an app, you then use the XenMobile console to add the app to XenMobile and change the policy configuration as needed. You can also add app categories, apply workflows, and deploy apps to delivery groups. See [About the MDX Toolkit](#).
- StoreFront (optional). You can provide access to Windows-based apps and virtual desktops from StoreFront through connections with Receiver.
- ShareFile Enterprise (optional). If you deploy ShareFile, you can enable enterprise directory integration through XenMobile, which acts as a Security Assertion Markup Language (SAML) identity provider. For more information about configuring identity providers for ShareFile, see the ShareFile support site.

XenMobile provides device management and app management through the XenMobile console. This section describes the reference architecture for the XenMobile deployment.

In a production environment, Citrix recommends deploying the XenMobile solution in a cluster configuration for both scalability and server redundancy. Also, using the NetScaler SSL Offload capability can further reduce the load on the XenMobile Server and increase throughput. For more information about how to set up clustering for XenMobile by

configuring two load balancing virtual IP addresses on NetScaler, see [Clustering](#).

For more information about configuring XenMobile for a disaster recovery deployment, see the Deployment Handbook [Disaster Recovery](#) article. That article includes an architecture diagram.

The following sections describe different reference architectures for the XenMobile deployment. For reference architecture diagrams, see the XenMobile Deployment Handbook articles, [Reference Architecture for On-Premises Deployments](#) and [Reference Architecture for Cloud Deployments](#). For a complete list of ports, see [Port requirements](#) (on-premises) and [Port requirements](#) (cloud).

Mobile device management (MDM) mode

XenMobile MDM Edition provides mobile device management. For platform support, see [Supported device operating systems](#). If you plan to use only the MDM features of XenMobile, you deploy XenMobile in MDM mode. For example, if you want to do the following.

- Deploy device policies and apps.
- Retrieve asset inventories.
- Carry out actions on devices, such as a device wipe.

In the recommended model, the XenMobile Server is positioned in the DMZ with an optional NetScaler in front, which provides more protection for XenMobile.

Mobile app management (MAM) mode

MAM, also called MAM-only mode, provides mobile app management. For platform support, see [Supported device operating systems](#). If you plan to use only the MAM features of XenMobile without having devices enroll for MDM, you deploy XenMobile in MAM mode. For example, if you want to do the following.

- Secure apps and data on BYO mobile devices.
- Deliver enterprise mobile apps.
- Lock apps and wipe their data.

The devices cannot be MDM enrolled.

In this deployment model, XenMobile Server is positioned with NetScaler Gateway in front, which provides more protection for XenMobile.

MDM+MAM mode

Using MDM and MAM modes together provides mobile app and data management and mobile device management. For platform support, see [Supported device operating systems](#). If you plan to use MDM+MAM features of XenMobile, you deploy XenMobile in ENT (enterprise) mode. For example, if you want to:

- Manage a corporate-issued device by using MDM
- Deploy device policies and apps
- Retrieve an asset inventory
- Wipe devices
- Deliver enterprise mobile apps
- Lock apps and wipe the data on devices

In the recommended deployment model, the XenMobile Server is positioned in the DMZ with NetScaler Gateway in front,

which provides more protection for XenMobile.

XenMobile in the internal network - Another deployment option is to position an on-premises XenMobile Server in the internal network, rather than in the DMZ. This deployment is used if your security policy requires that only network appliances can be placed in the DMZ. In this deployment, the XenMobile Server is not in the DMZ. Therefore, there is no requirement to open ports on the internal firewall to allow access to SQL Server and PKI servers from the DMZ.

System requirements and compatibility

Jul 05, 2017

For more requirements and compatibility information, see the following articles:

- [XenMobile compatibility](#)
- [Supported device operating systems](#)
- [Port requirements](#)
- [Scalability](#)
- [Licensing](#)
- [FIPS 140-2 compliance](#)
- [Language support](#)

To run XenMobile 10.6, you need the following minimum system requirements:

- One of the following:
 - XenServer (supported versions: 6.5.x, 7.0, 7.1, 7.2); for details, see [XenServer](#)
 - VMware (supported versions: ESXi 6.0, ESXi 6.5.0, or ESXi 6.5.0d); for details, see [VMware](#)
 - Hyper-V (supported versions: Windows Server 2008 R2, Windows Server 2012, or Windows Server 2012 R2); for details, see [Hyper-V](#)
- Dual core processor
- Four virtual CPUs
- 8 GB of RAM for production environments; 4 GB of RAM for proof of concept and test environments
- 50 GB of disk space

XenMobile version 10.6 requires the 11.12.1 Citrix License Server or later.

NetScaler Gateway system requirements

To run NetScaler Gateway with XenMobile 10.6, you need the following minimum system requirements.

- NetScaler Gateway. Supported versions: 12.0, 11.1.x, 11.0.x, 10.5.x)
- One of the following:
 - XenServer (supported versions: 6.5 or 7.0)
 - VMWare (supported versions: ESXi 4.1, ESXi 5.1, ESXi 5.5, ESXi 6.0)
 - Hyper-V (supported versions: Windows Server 2008 R2, Windows Server 2012, or Windows Server 2012 R2)
- Two virtual CPUs
- 2 GB of RAM
- 20 GB of disk space

You also must be able to communicate with Active Directory, which requires a service account. You only need query and read access.

XenMobile 10.6 Database Requirements

XenMobile requires one of the following databases:

- Microsoft SQL Server

The XenMobile repository supports a Microsoft SQL Server database running on one of the following supported

versions. For more information about Microsoft SQL Server databases, see [Microsoft SQL Server](#).

Microsoft SQL Server 2016
Microsoft SQL Server 2014
Microsoft SQL Server 2012
Microsoft SQL Server 2008 R2
Microsoft SQL Server 2008

XenMobile 10.6 supports SQL Basic Availability Groups (Always On Availability Groups) and SQL Clustering for database high availability.

Citrix recommends using Microsoft SQL remotely.

Note: Ensure that the service account of the SQL Server to be used on XenMobile has the DBcreator role permission. For more information about SQL Server service accounts, see the following pages on the Microsoft Developer Network site. These links point to information for SQL Server 2014. If you are using a different version, choose your server version from the **Other Versions** list:

[Server Configuration - Service Accounts](#)

[Configure Windows Service Accounts and Permissions](#)

[Server-Level Roles](#)

- PostgreSQL (for test environments only). PostgreSQL is included with XenMobile. You can use it locally or remotely in test environments.

Note: All XenMobile editions support Remote PostgreSQL 9.5.2 and 9.3.11 for Windows with the following limitations: Support for up to 300 devices. Use on-premises SQL Server for more than 300 devices; No support for clustering.

StoreFront Compatibility

StoreFront 3.9
StoreFront 3.8
StoreFront 3.7
StoreFront 3.6
StoreFront 3.5
StoreFront 3.0
Web Interface 5.4
XenApp and XenDesktop 7.13
XenApp and XenDesktop 7.12
XenApp and XenDesktop 7.11
XenApp and XenDesktop 7.9
XenApp and XenDesktop 7.8
XenApp and XenDesktop 7.7
XenApp and XenDesktop Long Term Service Release (LTSR)
XenApp and XenDesktop 7.6
XenApp and XenDesktop 7.5
XenApp 6.5

XenMobile 10.6 Mail Server Requirements

XenMobile 10.6 supports the following mail servers:

- Exchange 2016
- Exchange 2013
- Exchange 2010
- Office 365

XenMobile compatibility

Aug 18, 2017

Important

Citrix supports both enterprise distribution and public app store distribution for XenMobile productivity apps until December 31, 2017. For details, see the [Citrix product matrix](#). You must move to the public app store apps before this date. After that, only public app store distribution is supported. For more information about the in-app guide for moving from the enterprise versions of XenMobile Apps to the public store versions, see [In-app guide for migrating to public store apps](#). The MDX Toolkit continues to support enterprise wrapping for app developers.

This article summarizes the versions of the supported XenMobile components that you can integrate. Those components include NetScaler Gateway and the version of the MDX Toolkit required to wrap, configure, and distribute XenMobile Apps.

Supported versions and upgrade paths

For the XenMobile Server and apps, Citrix supports the current and prior two versions of XenMobile. For example, if the current version is XenMobile Server 10.6, Citrix also supports versions 10.5 and 10.4. A version includes both releases and service packs. XenMobile 10.4 is a service pack rather than a full release.

XenMobile 9. This version reached the End of Life (EOL) lifecycle status as of June 30, 2017. For more information about product lifecycle milestones, see the [Product Matrix](#). Since the EOL date and for five years beyond the EOL date, you can download a PDF of the XenMobile 9 documentation from the [Archive List of Legacy Documents](#). For more information about moving from XenMobile 9 XenMobile 10.x or to XenMobile Service via Citrix Cloud, see this [Citrix.com](#) page.

	Upgrade support statement	Latest version	Upgrade from
Enterprise wrapped apps (such as Secure Mail and Secure Web)	Last two versions	10.6 (iOS), 10.6.20 (Android)	10.4.5 or 10.6
Public store apps (such as Secure Hub, Secure Mail, and Secure Web)	Last two versions Users who have automatic updates enabled receive the latest version from the app store. The latest app supports the previous two MDX files.	10.6.20 (Secure Hub) 10.6.20 (Secure Mail) 10.6.20 (Secure Web)	10.6.10 or 10.6.15 (Secure Hub) 10.6.10 or 10.6.15 (Secure Mail) 10.5.10 or 10.6.15 (Secure Web) For example, a 10.6.20 version of Secure Mail is

			compatible with a 10.6.10 or 10.6.15 MDX file.
MDX	Previous version	10.6.20	10.6.15
Server (on-premises)	All earlier 10.x versions and from XenMobile 9 with Rolling Patch 9	10.6	10.x, XenMobile 9 with Rolling Patch 9. For upgrade paths, see Upgrade .

XenMobile compatibility

To use new features, fixes, and policy updates, Citrix recommends that you install the most recent version of the MDX Toolkit, Secure Hub, and XenMobile Apps.

- Apps, MDX Toolkit, and Secure Hub for enterprise distribution:
 - The latest version of the apps and MDX Toolkit requires the latest version of Secure Hub.
 - The latest version of the MDX Toolkit is required for the latest version of the apps.
 - The previous two versions of the apps and the previous version of the MDX Toolkit are compatible with the latest Secure Hub.
- Client and server: The latest versions of Secure Hub, MDX Toolkit, and XenMobile Apps are compatible with the latest version, plus the two prior versions, of XenMobile Server.
- The public store apps are only compatible with XenMobile 10.4 and later.
- The Enterprise wrapped apps are no longer compatible with XenMobile 9 because XenMobile 9 reached End of Life in June 2017.

Supported NetScaler Gateway versions:

- 12.0
- 11.1.x
- 11.0.x
- 10.5.x

MDX Toolkit for iOS and Android versions	Compatible Secure Hub versions	
	Android	iOS
10.6.20 (Android)	10.6.20	10.6.20
10.6 (iOS)	10.5.15	10.5.15
10.4.10		
MDX Toolkit for Windows Phone	Compatible Secure Hub versions	

10.3.9	10.3.5
10.3.1	10.3

Note

XenMobile 10.1 doesn't support Windows Phone 10.

Apps available on public app stores

	Android	iOS
Secure Hub	10.6.20	10.6.20
Secure Mail	10.6.20	10.6.20
Secure Web	10.6.20	10.6.20
Secure Notes	10.6.20	10.4.5
Secure Tasks	10.6.20	10.4.5
QuickEdit	6.12	6.12
ShareFile	5.5	5.4
ShareConnect		3.3
ScanDirect		1.2.2

Apps available for enterprise distribution

XenMobile 10.x supports the XenMobile Apps versions listed in the following table.

Note:

- XenMobile 10.1 doesn't support Windows Phone 10.
- XenMobile supports only the most recent versions of QuickEdit, ShareConnect, and ShareFile.

App	iOS	Android	Windows Phone
Worx Home			10.0.3 10.0.0
Secure Forms		10.4.5 10.4.1	
Secure Mail	10.6 10.4.6	10.6.20 10.6	
Secure Notes	10.4.5 10.4.1	10.6.20 10.4.5	
Secure Tasks	10.4.5 10.4.1	10.6.20 10.4.5	
Secure Web	10.4.5 10.4.1	10.6.20 10.4.5	
QuickEdit	6.12	6.12	
ScanDirect		1.2.2	
ShareConnect	3.2.341	3.5	
ShareFile	5.5	5.4	

Browser support

XenMobile 10.x supports the following browsers:

- Internet Explorer, though not versions 9 or earlier
- Chrome
- Firefox
- Safari on mobile devices for use with the Self Help Portal

XenMobile 10.x is compatible with the most current version of the browser and one version before the current version.

Supported device operating systems

Aug 18, 2017

XenMobile supports devices running the following platforms and operating systems for enterprise mobility management, including app and device management. Because of platform restrictions and security features, XenMobile doesn't support all functionality on all platforms.

The supported device platform information in this article also applies to XenMobile Mail Manager and XenMobile NetScaler Connector.

Android O and iOS 11 support

XenMobile supports Android O (version 8) and iOS 11 when these operating systems release. For more information about testing and preparing for these releases, see this [Citrix Knowledge Center article](#). The article also discusses the end of support for the following device operating systems and features:

Android

Important

Before upgrading to Android O (version 8), users **must** upgrade Secure Hub and all XenMobile Apps to version 10.6.20. Otherwise, users might not be able to sign on to Secure Hub or open XenMobile Apps. For more information about XenMobile Apps and Android 8, see [What's new in XenMobile Apps](#), and [Known issues](#).

- **Android 5.** With the release of Android O, Android 5 becomes the minimum supported version.
- **Android 4.4.x.** With the release of Android O, support ends for Android 4.4.x. Users can install apps from the public app store on devices running Android 4.4 until November 1. Citrix, however, no longer tests compatibility with version 4.4.

Keep the following in mind for users with Android 4.4 devices running versions 10.6.15 and earlier of Secure Mail and Secure Web:

Public app store 10.6.15 versions of Secure Mail and Secure Web for Android 4.4. Users can update Secure Mail and Secure Web to version 10.6.20 or do new installations of these versions. The apps, however, will not get bug fixes or enhancements for these versions. The features and fixes in the apps remain the same as in version 10.6.15.

Enterprise 10.6 versions of Secure Mail and Secure Web for Android. They can update to Secure Hub 10.6.20 and keep using Secure Mail and Secure Web 10.6.0. If you wrap version 10.6.20 of Secure Mail or Secure Web for upload to the XenMobile console, users must use a device running Android 5.x and later. This requirement therefore means that users cannot update Secure Mail and Secure Web on their Android 4.4 devices to version 10.6.20. If you do try to push 10.6.20 apps wrapped with MDX 10.6.20, Android 4.4. users also cannot use any 10.6.0 or earlier enterprise app that they have installed.

If users running Android 4.4 want to continue using updated versions of Secure Mail and Secure Web, they must use a device running Android 5.x or later.

- **Android 4.4 in MDM mode.** Support continues for Android 4.4 in MDM-only mode.
- **SSLv3.** Google support for SSLv3 connections ends. XenMobile Apps that run on an Android O device cannot connect to

internal servers that use SSLv3 connections. Plan ahead to anticipate this change to avoid connectivity issues for users.

iOS

- **iOS 8.** Support for iOS 8 is currently for devices in MDM-only mode. Support for iOS 8 devices ends when support for iOS 11 begins.
- **iOS 9.** Support ends for iOS 9 devices running XenMobile Apps for approximately six weeks following the start of support for iOS 11. After that, Citrix no longer tests compatibility with iOS 9.
- **iOS 9 in MDM mode.** Support continues for iOS 9 devices in MDM mode.
- **SHA-1 certificates.** Secure Hub no longer supports SHA-1 certificates on devices running iOS 11. To avoid related issues, users must update to Secure Hub 10.6.10 or later before upgrading their devices to iOS 11. For more information about anticipating this change, see the Knowledge Center article on [XenMobile iOS 11 and Android O Support](#).

To support older versions of mobile operating systems, such as Android 4.1 and iOS 7, see [article CTX204192](#) in the Citrix Knowledge Center.

Note

- Citrix supports, at a minimum, the current and prior version of each major operating system platform. Not all features of the newer version of XenMobile work on older platform releases. This article details what Citrix supports for each operating system. This article also includes device models that Citrix tested. For issues with other device models, contact Citrix support.
- As of version 10.4, Worx Mobile Apps are renamed to XenMobile Apps. All XenMobile Apps are renamed. For details, see [About XenMobile Apps](#).

Android

XenMobile 10.x

Operating systems supported for all modes: Android 5.x, 6.x, 7.x, 8

Operating systems supported for MDM-only mode: Android 4.4

Worx Home/Secure Hub is supported on x86 and x64-based Android devices for MDM capabilities. On XenMobile 10 and 10.1, app management is only available on Android devices with ARM-based processors. MDX-wrapped applications are not supported on Android x86 and x64-based devices.

Android devices and operating systems tested specifically on XenMobile 10.x in MDM+MAM (enterprise) mode

- Google Nexus 9 Tablet (operating system 7.0)
- Google Nexus 5 (operating system 6.0.1)
- Google Nexus 5X (operating system 7.1.1)
- Google Pixel (operating system 7.0)
- Galaxy S8 (operating system 7.1.2)
- Galaxy S7 (operating system 7.0)
- Galaxy S6 (operating system 6.0.1, 5.0)
- Galaxy Tab A (operating system 6.0)

- Galaxy Note3 model SM-N900 (operating system 5.0)
- Galaxy S4, GT-I9500 (operating system 5.0.1)
- Galaxy S6 Edge, SM-G925F (operating system 6.0.1)
- Galaxy S5 SM-G900F (operating system 6.0.1)
- Galaxy S5 SM-G900H (operating system 6.0.1)
- Huawei P10 Lite
- Huawei P10
- Huawei P8 Lite 2017
- Moto Turbo (operating system 6.0.1)
- Nexus 9 Tab (operating system 5.0.1)
- Nexus 9 Tab (operating system 5.1.1)
- Nexus 6P (operating system 7.1.1)
- Nexus 6 (operating systems 6.0.1 and 7.0)
- Nexus 5 (operating system 5.0.1)
- Sony Xperia, Model: SGP311 (operating system 5.0.1)
- Zebra (all models and operating systems)

Android devices and operating systems tested specifically on XenMobile 10.x in MDM-only mode

- Google Nexus 7 tablet (operating system 4.4.4)
- Google Nexus 9 tablet (operating system 7.0)
- Google Nexus 5 (operating system 6.0.1)
- Google Nexus 5X (operating system 7.1.1)
- Google Pixel (operating system 7.0)
- Galaxy S7 (operating system 7.0)
- Galaxy S8 (operating system 7.1.2)
- Galaxy S6 (operating system 6.0.1, 5.0)
- Galaxy Tab A (operating system 6.0)
- Galaxy Note3 model SM-N900 (operating system 5.0)
- Galaxy S4, GT-I9500 (operating system 5.0.1)
- Galaxy S3 model GT-I9305 (operating system 4.4.4)
- Galaxy S6 Edge, SM-G925F (operating system 6.0.1)
- Galaxy S5 SM-G900F (operating system 6.0.1)
- Galaxy S5 SM-G900H (operating system 6.0.1)
- HTC One M8 (operating system 4.4.2)
- Huawei Nexus 6 (operating systems 6.0.1 and 7.0)
- Huawei P10 Lite
- Huawei P10
- Huawei P8 Lite 2017
- Nexus 9 Tab (operating system 5.0.1)
- Nexus 9 Tab (operating system 5.1.1)
- Nexus 7 (operating system 4.4)
- Nexus 5 (operating system 5.0.1)
- Sony Xperia, Model: SGP311 (operating system 5.0.1)
- Zebra (all models and operating systems)

In addition, the following device types are tested with Secure Mail.

Device type	Operating system
Google Pixel	7.0 and 8.0
Samsung S8	7.0
Samsung S7	7.0
Samsung S6	6.0.1
Samsung S5	5
Samsung Tab A	6.0.1

SAFE and KNOX

On compatible Samsung devices, XenMobile 10.x supports and extends both Samsung for Enterprise (SAFE) and Samsung KNOX policies. XenMobile requires that you enable the SAFE APIs before you deploy SAFE policies and restrictions. To do that, deploy the built-in Samsung Enterprise License Management (ELM) key to a device. To enable the Samsung KNOX API:

1. Purchase a Samsung KNOX license by using the Samsung KNOX License Management System (KLMS).
2. Deploy the Samsung ELM key.

For HTC-specific policies, XenMobile supports HTC API version 0.5.0. For Sony-specific policies, XenMobile supports Sony Enterprise SDK 2.0.

iOS

Note

iOS 10.3 devices don't support self-signed certificates. If XenMobile uses self-signed certificates, users can't enroll iOS 10.3 devices in XenMobile. To enroll devices running iOS 10.3 or later in XenMobile, you must use trusted SSL certificates in XenMobile.

All Worx apps/XenMobile Apps are compatible with iOS 10, starting with versions 10.3.10 or later. Use the MDX Toolkit 10.3.10 or later to wrap mobile or enterprise apps to ensure proper compatibility with iOS 10. If users upgrade to iOS 10, they must also upgrade to Worx Home 10.3.10 or later (Secure Hub) to use MDX apps.

XenMobile 10.3.x, 10.4, and 10.5

- iOS 10.x
- iOS 9.x
- iOS 8.x (Worx Home/Secure Hub only in MDM-only deployments)

Some iOS devices that XenMobile 10.3.x and 10.4 support:

- iPhone 7+ 10.2.1 (XenMobile 10.5 and later)
- iPhone 6, 6+, 6S, 6S+, 5s, 5, 5c
- iPad 2, 3
- iPad Air, iPad Air-2, iPad Mini-4, Mini-3, Mini-2
- iPad Pro
- macOS
 - MacBook, Air, Mini, Mini Retina 10.9.5, 10.10, 10.11

XenMobile 10 and 10.1

- iOS 10.x
- iOS 9.x
- iOS 8.x (Worx Home only in MDM-only deployments)

Some iOS devices that XenMobile 10 and 10.1 support:

- iPhone 5, 5s, 5c, 6, 6+
- iPad2, 3, Mini, Air, Air2, Mini Retina

MacOS

XenMobile 10.3.x, 10.4, and 10.5

- MacBook
- MacBook Air
- Mac Mini
- Mac Mini Retina 10.9.5, 10.10, 10.11

XenMobile 10 and 10.1

- MacBook Air
- MacBook Air 2
- Mac Mini
- Mac Mini Retina

Windows Phone and Tablet

XenMobile 10.5

- Windows 10 RS1 and RS2 Phone and Tablet
 - Not supported when XenMobile is in MAM-only mode.
- Windows Phone 8.1 and 10 compatibility with Worx Home (not rebranded to Secure Hub).

- When XenMobile is in Enterprise mode: Worx Home 10.2.
- When XenMobile is in MDM-only mode: Worx Home 9.1.0.
- Windows Mobile/CE
 - Not supported if XenMobile is in MAM-only mode.

XenMobile 10.3.x and 10.4

- Windows 10 RS1, 8.1 tablet
 - When XenMobile is in MAM-only mode, Windows 10 tablet is not supported.
- Windows Tablet Surface Pro 3, Surface 2, RT
- Windows Phone 8.1 and 10
 - For Windows Phone 10, you must install a patch from the [XenMobile downloads page](#).
 - Not supported when XenMobile is in MAM-only mode.
- Windows Phone 8.1 compatibility with Worx Home:
 - When XenMobile is in Enterprise mode: Worx Home 10.0
 - When XenMobile is in MDM-only mode: Worx Home 9.1.0
- Windows 8.1 Pro and Enterprise editions (32-bit and 64-bit)
- Windows RT 8.1
- Windows Mobile/CE
 - Not supported when XenMobile is in MAM-only mode.

Some Windows devices that XenMobile 10.3 supports:

- Windows Tablet 8.1 and 10
- Windows Phone 8.1 and 10
- HTC (Windows Phone 8.1)
- Nokia 920, 925, 1020, 1520 (Windows Phone 8.1)
- Windows Tablet Surface Pro 3
- Windows Tablet Surface 2
- Windows Tablet RT

XenMobile 10 and 10.1

- Windows 10 RS1 Tablet
- Windows Phone 8.1 and 10:
 - When XenMobile is in MAM-only mode, Windows Phone 8.1 is not supported.
 - Windows Phone 10 is supported on XenMobile 10.3 and later.
 - Windows Phone 10 is supported on XenMobile 9, but you must install a Device Manager rolling patch, as discussed in this [Knowledge Center article](#). Also, take note of the patch for the Windows 10 Anniversary Update Version 1607 for Windows phones. For details, see this [Knowledge Center article](#).
- Windows Phone 8.1 compatibility with Worx Home:
 - When XenMobile is in Enterprise mode: Worx Home 10.0
 - When XenMobile is in MDM-only mode: Worx Home 9.0.3
- Windows 8.1 Pro and Enterprise editions (32-bit and 64-bit)
- Windows RT 8.1
- Windows Mobile/CE: XenMobile 10.1 does not support Windows Mobile or Windows CE devices.

Some Windows devices that XenMobile 10 and 10.1 support:

- Windows Tablet 8.1
- HTC (Windows Phone 8.1)
- Nokia 920, 925, 1020, 1520 (Windows Phone 8.1)
- Windows Tablet Surface Pro 3
- Windows Tablet Surface 2
- Windows Tablet RT

Management of Windows Phone 7 is provided through XenMobile Mail Manager. For details, see [Installing XenMobile Mail Manager](#).

Symbian

XenMobile 10.3.x, 10.4, and 10.5

XenMobile 10.3.x, 10.4, and 10.5 do not support Symbian.

XenMobile 10 and 10.1

The following list includes some of the Symbian devices XenMobile 10.1 and 10 support. In XenMobile 10, they're supported for device management only:

- Symbian 3
- Symbian S60 5th Edition
- Symbian S60 3rd Edition, Feature Pack 2
- Symbian S60 3rd Edition, Feature Pack 1
- Symbian S60 3rd Edition
- Symbian S60 2nd Edition, Feature Pack 3
- Symbian S60 2nd Edition, Feature Pack 2

BlackBerry

Management of BlackBerry devices is provided through XenMobile Mail Manager. For details, see [Installing XenMobile Mail Manager](#).

Port requirements

Jun 19, 2017

To enable devices and apps to communicate with XenMobile, you open specific ports in your firewalls. The following tables list the ports that must be open. For port requirements for XenMobile Service, see [Port requirements](#).

Open ports for NetScaler Gateway and XenMobile to manage apps

Open the following ports to allow user connections from Citrix Secure Hub, Citrix Receiver, and the NetScaler Gateway Plug-in through NetScaler Gateway to the following components:

- XenMobile
- StoreFront
- XenDesktop
- XenMobile NetScaler Connector
- Other internal network resources, such as intranet websites

To enable traffic to Launch Darkly from NetScaler, you can use the IP addresses noted in this [Support Knowledge Center article](#).

For more information about NetScaler Gateway, see [Configuration Settings for your XenMobile Environment](#) in the NetScaler Gateway documentation. For more information about IP addresses owned by NetScaler, see [How a NetScaler Communicates with Clients and Servers](#) in the NetScaler documentation. That section includes information about NetScaler IP (NSIP) virtual server IP (VIP) and subnet IP (SNIP) addresses.

TCP port	Description	Source	Destination
21 or 22	Used to send support bundles to an FTP or SCP server.	XenMobile	FTP or SCP server
53 (TCP and UDP)	Used for DNS connections.	NetScaler Gateway XenMobile	DNS server
80	NetScaler Gateway passes the VPN connection to the internal network resource through the second firewall. This situation typically occurs if users log on with the NetScaler Gateway Plug-in.	NetScaler Gateway	Intranet websites

80 or 8080	XML and Secure Ticket Authority (STA) port used for enumeration, ticketing, and authentication.	StoreFront and Web Interface XML network traffic	XenDesktop or XenApp
443	Citrix recommends using port 443.	NetScaler Gateway STA	
123 (TCP and UDP)	Used for Network Time Protocol (NTP) services.	NetScaler Gateway XenMobile	NTP server
389	Used for insecure LDAP connections.	NetScaler Gateway XenMobile	LDAP authentication server or Microsoft Active Directory
443	Used for connections to StoreFront from Citrix Receiver or Receiver for Web to XenApp and XenDesktop.	Internet	NetScaler Gateway
	Used for connections to XenMobile for web, mobile, and SaaS app delivery.	Internet	NetScaler Gateway
	Used for general device communication to XenMobile Server	XenMobile	XenMobile
	Used for connections from mobile devices to XenMobile for enrollment.	Internet	XenMobile
	Used for connections from XenMobile to XenMobile NetScaler Connector.	XenMobile	XenMobile NetScaler Connector
	Used for connections from XenMobile NetScaler Connector to XenMobile.	XenMobile NetScaler Connector	XenMobile
	Used for Callback URL in deployments without certificate authentication.	XenMobile	NetScaler Gateway
514	Used for connections between XenMobile and a syslog server.	XenMobile	Syslog server
636	Used for secure LDAP connections.	NetScaler Gateway	LDAP authentication server or Active Directory

		XenMobile	
1494	Used for ICA connections to Windows-based applications in the internal network. Citrix recommends keeping this port open.	NetScaler Gateway	XenApp or XenDesktop
1812	Used for RADIUS connections.	NetScaler Gateway	RADIUS authentication server
2598	Used for connections to Windows-based applications in the internal network using session reliability. Citrix recommends keeping this port open.	NetScaler Gateway	XenApp or XenDesktop
3268	Used for Microsoft Global Catalog insecure LDAP connections.	NetScaler Gateway XenMobile	LDAP authentication server or Active Directory
3269	Used for Microsoft Global Catalog secure LDAP connections.	NetScaler Gateway XenMobile	LDAP authentication server or Active Directory
9080	Used for HTTP traffic between NetScaler and the XenMobile NetScaler Connector.	NetScaler	XenMobile NetScaler Connector
9443	Used for HTTPS traffic between NetScaler and the XenMobile NetScaler Connector.	NetScaler	XenMobile NetScaler Connector
45000 80	Used for communication between two XenMobile VMs when deployed in a cluster.	XenMobile	XenMobile
8443	Used for enrollment, XenMobile Store, and mobile app management (MAM).	XenMobile NetScaler Gateway Devices Internet	XenMobile
4443	Used for accessing the XenMobile console by an administrator through the browser.	Access point (browser)	XenMobile
	Used for downloading logs and support	XenMobile	XenMobile

	bundles for all XenMobile cluster nodes from one node.		
27000	Default port used for accessing the external Citrix License Server	XenMobile	Citrix License Server
7279	Default port used for checking Citrix licenses in and out.	XenMobile	Citrix Vendor Daemon

Open XenMobile ports to manage devices

Open the following ports to allow XenMobile to communicate in your network.

TCP port	Description	Source	Destination
25	Default SMTP port for the XenMobile notification service. If your SMTP server uses a different port, ensure that your firewall does not block that port.	XenMobile	SMTP server
80 and 443	Enterprise App Store connection to Apple iTunes App Store (ax.itunes.apple.com), Google Play (must use 80), or Windows Phone Store. Used for publishing apps from the app stores through Citrix Mobile Self-Serve on iOS, Secure Hub for Android, or Secure Hub for Windows Phone.	XenMobile	Apple iTunes App Store (ax.itunes.apple.com and *.mzstatic.com) Apple Volume Purchase Program (vpp.itunes.apple.com) For Windows Phone: login.live.com and *.notify.windows.com Google Play (play.google.com)
80 or 443	Used for outbound connections between XenMobile and Nexmo SMS Notification Relay.	XenMobile	Nexmo SMS Relay Server
389	Used for insecure LDAP connections.	XenMobile	LDAP authentication server or Active Directory
443	Used for enrollment and agent setup for Android and Windows Mobile.	Internet	XenMobile

	Used for enrollment and agent setup for Android and Windows devices, the XenMobile web console, and MDM Remote Support Client.	Internal LAN and WiFi	
1433	Used by default for connections to a remote database server (optional).	XenMobile	SQL Server
2195	Used for Apple Push Notification service (APNs) outbound connections to gateway.push.apple.com for iOS device notifications and device policy push.	XenMobile	Internet (APNs hosts using the public IP address 17.0.0.0/8)
2196	Used for APNs outbound connections to feedback.push.apple.com for iOS device notification and device policy push.		
5223	Used for APNs outbound connections from iOS devices on Wi-Fi networks to *.push.apple.com.	iOS devices on WiFi networks	Internet (APNs hosts using the public IP address 17.0.0.0/8)
8081	Used for app tunnels from the optional MDM Remote Support Client. Defaults to 8081.	Remote Support Client	Internet, for app tunnels to user devices (Android and Windows only)
8443	Used for enrollment of iOS and Windows Phone devices.	Internet LAN and WiFi	XenMobile

Port requirement for Auto Discovery Service connectivity

This port configuration ensures that Android devices connecting from Secure Hub for Android can access the Citrix Auto Discovery Service (ADS) from within the internal network. The ability to access the ADS is important when downloading any security updates made available through the ADS.

Note: ADS connections might not support your proxy server. In this scenario, allow the ADS connection to bypass the proxy server.

If you want to enable certificate pinning, do the following prerequisites:

- **Collect XenMobile Server and NetScaler certificates.** The certificates must be in PEM format and must be a public certificate and not the private key.
- **Contact Citrix Support and place a request to enable certificate pinning.** During this process, you are asked for

your certificates.

Certificate pinning requires that devices connect to ADS before the device enrolls. This requirement ensures that the latest security information is available to Secure Hub for the environment in which the device is enrolling. For Secure Hub to enroll a device, the device must reach the ADS. Therefore, opening up ADS access within the internal network is critical to enabling devices to enroll.

To allow access to the ADS for Secure Hub for Android, open port 443 for the following FQDN and IP addresses:

FQDN	IP address
	54.225.219.53
	54.243.185.79
	107.22.184.230
	107.20.173.245
discovery.mdm.zenprise.com	184.72.219.144
	184.73.241.73
	54.243.233.48
	204.236.239.233
	107.20.198.193

Scalability and performance

Jun 23, 2017

Understanding the scale of your XenMobile infrastructure plays a significant role in how you decide to deploy and configure XenMobile. This article contains data from scalability tests and guidance on determining infrastructure requirements for performance and scalability for small- to large-scale, on-premises XenMobile enterprise deployments.

Scalability is defined here in terms of the ability of devices already enrolled in the deployment to reconnect to the deployment at the same time.

- *Scalability* is defined as the maximum number of devices enrolled in the deployment.
- *Login Rate* is defined maximum rate at which existing devices can reconnect to the deployment.

The data in this article are derived from testing on deployments ranging in size from 10,000 to 75,000 devices. The tests comprised mobile device using known workloads.

All testing was done on XenMobile Enterprise edition.

Testing was done using the NetScaler Gateway 8200. NetScaler appliance with similar or greater capacity can be expected to produce similar or greater scalability and performance.

This table summarizes the scalability test results:

Scalability	Up to 75,000 devices	
Login rate	Reconnection rate of existing users	Up to 9,375 devices per hour
Configuration	NetScaler Gateway	MPX 8200
	XenMobile Enterprise Edition	XenMobile Server 7-node cluster
	Database	Microsoft SQL Server external database

Test results by device population and hardware configuration

This table provides scalability test results for deployment device populations and hardware configurations tested.

Number of devices	10,000	30,000	60,000	75,000
Reconnection rate of	1,250	3,750	7,500	9,375

existing devices per hour				
XenMobile Server - mode	Standalone	Cluster	Cluster	Cluster
XenMobile Server - cluster	N/A	3	5	7
XenMobile Server - virtual appliance	Memory = 8 GB RAM vCPUs = 4	Memory = 16 GB RAM vCPUs = 6	Memory = 24 GB RAM vCPUs = 8	Memory = 24 GB RAM vCPUs = 8
Active Directory	Memory = 4 GB RAM vCPUs = 2	Memory = 8 GB RAM vCPUs = 4	Memory = 16 GB RAM vCPUs = 4	Memory = 16 GB RAM vCPUs = 4
Microsoft SQL Server external database	Memory = 8 GB RAM vCPUs = 4	Memory = 16 GB RAM vCPUs = 8	Memory = 48 GB RAM vCPUs = 24	Memory = 48 GB RAM vCPUs = 24

Scalability profile

These tables summarize the test profile used derive the data in this article:

Active Directory Configuration	Profile used
Users	100,000
Groups	200,000
Levels of nesting	5

XenMobile Server Configuration	Total	Per user
Policies	20	20
Apps	270	50

Public app	200	0
MDX	50	30
Web and SaaS	20	20
Actions	50	
Delivery groups	20	
Active Directory groups per delivery group	10	

SQL	
Number of databases	1

Device connections and app activities

These scalability tests collected data on the ability of devices enrolled in a deployment to reconnect over an 8-hour period.

The tests simulated a reconnect interval during which reconnecting devices obtain all entitled security policies, subjecting XenMobile Server nodes to higher than normal load conditions. During subsequent reconnections, only changed or new policies are pushed to iOS devices, lessening the load on the XenMobile Server nodes.

These tests used a mix of 50 percent iOS devices and 50 percent Android devices.

These tests assume the reconnecting Android devices have received prior GCM notifications.

During the 8-hour test interval, the following app-related activities occurred:

- Secure Hub was opened once to enumerate entitled apps
- 2 SAML web apps were opened
- 4 MAM apps were downloaded
- 1 STA was generated for use by Secure Mail
- 240 STA ticket validations, one for each Secure Mail reconnect event over a micro-VPN, were performed.

Reference architecture

For the reference architecture for deployments used in these scalability tests, see "Core MAM+MDM Reference Architecture" in [Reference Architecture for On-Premises Deployments](#).

Caveats and limitations

Note the following when considering the scalability test results in this article:

- Windows platform was not tested.
- Policy push was tested for iOS and Android devices.
- Each XenMobile Server node supports a maximum of 12,000 devices simultaneously.

Licensing

Jun 19, 2017

Licensing differs for XenMobile Service and XenMobile Server:

- Citrix Cloud Ops handles licensing for XenMobile Service.
- XenMobile Server and NetScaler Gateway require licenses.

For more information about NetScaler Gateway licensing, see [Licensing](#) in the NetScaler Gateway documentation. XenMobile uses Citrix Licensing to manage licenses. For more information about Citrix Licensing, see [The Citrix Licensing System](#).

When you purchase XenMobile Server, you receive an order confirmation email message containing instructions for activating your licenses. New customers must register for a license program before placing an order. For more information about XenMobile licensing models and programs, see [XenMobile licensing](#).

For a data sheet that shows which XenMobile features are available in each XenMobile edition, see this [PDF](#).

You must install Citrix Licensing before downloading your XenMobile licenses. The name of the server on which you installed Citrix Licensing is required to generate the license file. When you install XenMobile, Citrix Licensing is installed on the server by default. Alternatively, you can use an existing Citrix Licensing deployment to manage your XenMobile licenses. For more information about installing, deploying, and managing Citrix Licensing, see [Licensing Your Product](#).

Note

The latest version of XenMobile requires the 11.12.1 Citrix License Server or later. Older license server versions do not work with the latest version of XenMobile.

Important

If you intend to cluster nodes, or instances, of XenMobile, you must use Citrix Licensing on a remote server.

Citrix recommends that you retain local copies of all license files you receive. When you save a back-up copy of the configuration file, all license files are included in the backup. If, however, you reinstall XenMobile without first backing up the configuration file, you need the original license files.

XenMobile licensing considerations

In the absence of a license, XenMobile operates fully featured in trial mode for a grace period of 30 days. This trial mode can be used only one time, with the 30-day period beginning when you install XenMobile. Access to the XenMobile web console is never blocked, regardless of whether a valid XenMobile license is available. In the XenMobile console, you can see how many days are left in your trial period.

Although XenMobile allows you to upload multiple licenses, only one license can be activated at a time.

When a XenMobile license expires, you can no longer perform any device management functions. For example, new users or

devices cannot be enrolled, and apps and configurations deployed to enrolled devices cannot be updated. For more information about XenMobile licensing models and programs, see [XenMobile licensing](#).

To find the Licensing page on the XenMobile console

When the **Licensing** page first appears after you install XenMobile, the license is set for the default 30-day trial mode and is not yet configured. You can add and configure licenses on this page.

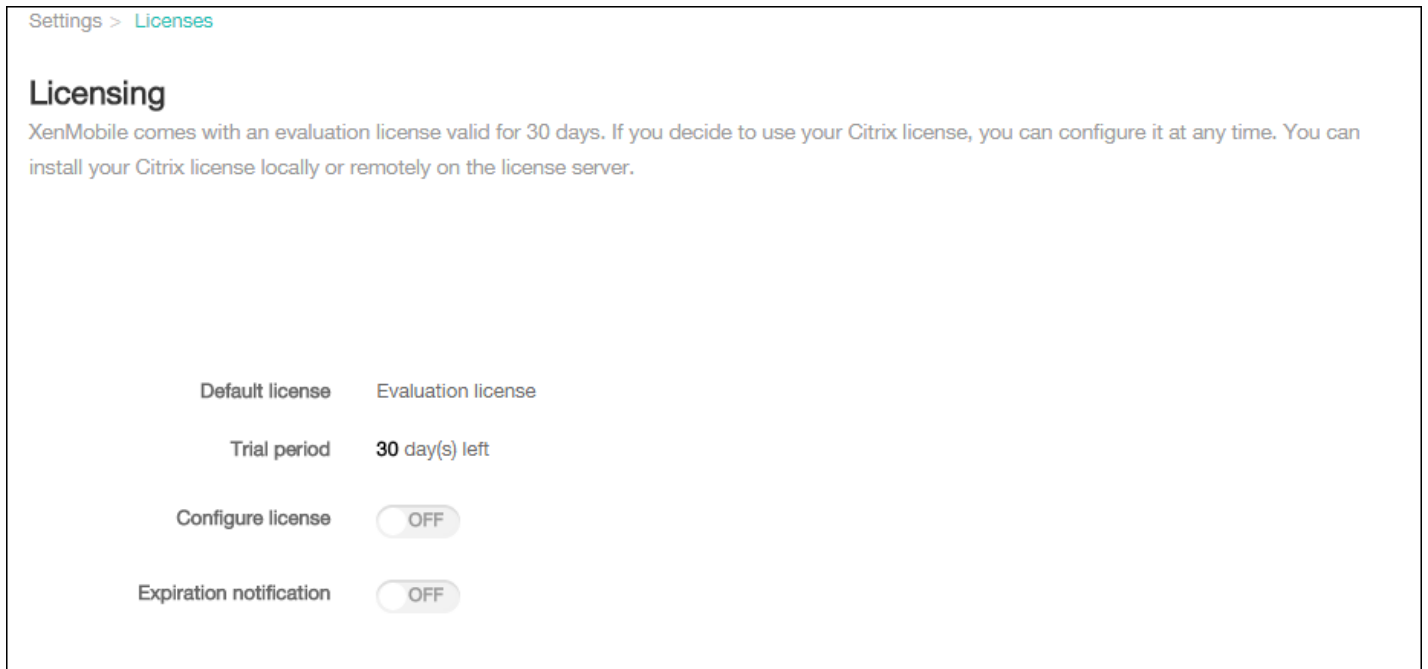

1. On the XenMobile console, click the gear icon in the upper right-hand corner. The **Settings** page appears.
2. Click **Licensing**. The **Licensing** page appears.

To add a local license

When adding new licenses, they appear in the table. The first license added is automatically activated. If you add multiple licenses of the same category, such as Enterprise and type, these licenses appear in a single row of the table. In these cases, the **Total number of licenses** and **Number used** reflect the combined amount for the common licenses. The **Expires on** date shows the latest expiration date among the common licenses.

You manage all local licenses through the XenMobile console.

1. Get a license file from the Simple License Service, through the License Administration Console, or directly from your account on Citrix.com. For details, see [Obtain your license files](#).
2. On the XenMobile console, click the gear icon in the upper right-hand corner. The **Settings** page appears.
3. Click **Licensing**. The **Licensing** page appears.
4. Set **Configure license** to **On**. The **License type** list, the **Add** button, and the **Licensing** table appear. The **Licensing** table contains licenses you have used with XenMobile. If you have not added a Citrix license yet, the table is empty.

Settings > Licenses

Licensing

XenMobile comes with an evaluation license valid for 30 days. If you decide to use your Citrix license, you can configure it at any time. You can install your Citrix license locally or remotely on the license server.

Default license: Evaluation license

Trial period: 30 day(s) left

Configure license: ON

License type: Local license

 Add

Product Name	Active	Total number of licenses	Number used	Type	Expires on
No results found.					

Expiration notification: OFF

5. Ensure that **License type** is set to **Local license** and then click **Add**. The **Add New License** dialog box appears.

Add New License ✕

License File No file chosen

6. In the **Add New License** dialog box, click **Choose File** and then browse to your license file location.

7. Click **Upload**. The license is uploaded locally and appears in the table.

License type: Local license

Add | Delete All

Product Name	Active	Total number of licenses	Number used	Type	Expires on
Citrix XenMobile Enterprise Edition[Device]	✓	15002	0	Retail	01-DEC-2015

Showing 1 - 1 of 1 items

Expiration notification: OFF

8. When the license appears in the table on the **Licensing** page, activate it. If the license is first in the table, the license is activated automatically.

To add a remote license

If you are using the remote Citrix Licensing server, you use the Citrix Licensing server to manage *all* licensing activity. For details, see [Licensing Your Product](#).

1. On the **Licensing** page, set **Configure license** to **On**. The **License type** list, the **Add** button, and the **Licensing** table appear. The **Licensing** table contains licenses you have used with XenMobile. If you have not added a Citrix license yet, the table is empty.

3. Set **License type** to **Remote license**. The **License server** and **Port** fields and the **Test Connection** button replace the **Add** button.

License type: Remote license

License server*:

Port*: 27000

Test Connection

Product name	Active	Total number of licenses	Number used	Type	Expires on
		1001	0	Retail	01-DEC-2015

4. Configure these settings:

- **License server:** Type the IP address or fully qualified domain name (FQDN) of your remote licensing server.
- **Port:** Accept the default port or type the port number used to communicate with the licensing server.

5. Click **Test Connection**. If the connection is successful, XenMobile connects with the Licensing server and the Licensing table is filled with available licenses. If there is only one license, it is activated automatically.

When you click **Text Connection**, XenMobile confirms the following:

- XenMobile can communicate with the license server.

- Licenses on the license server are valid.
- The license server is compatible with XenMobile.

If the connection is unsuccessful, review the displayed error message, make the necessary corrections, and then click **Test Connection**.

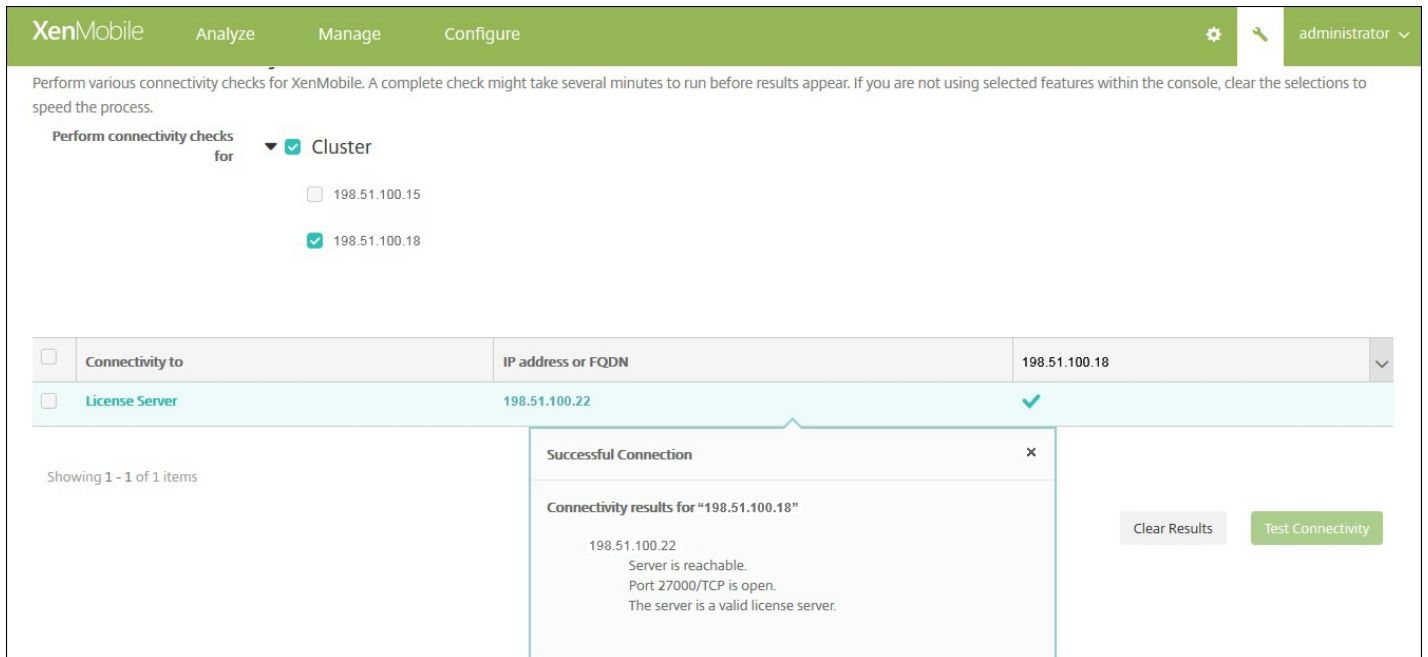

To activate a different license

If you have multiple licenses, you can choose the license you want to activate. You can have only one license active at a time, however.

1. On the **Licensing** page, in the **Licensing table**, click the row of the license you want to activate. An **Activate** confirmation dialog appears next to the row.

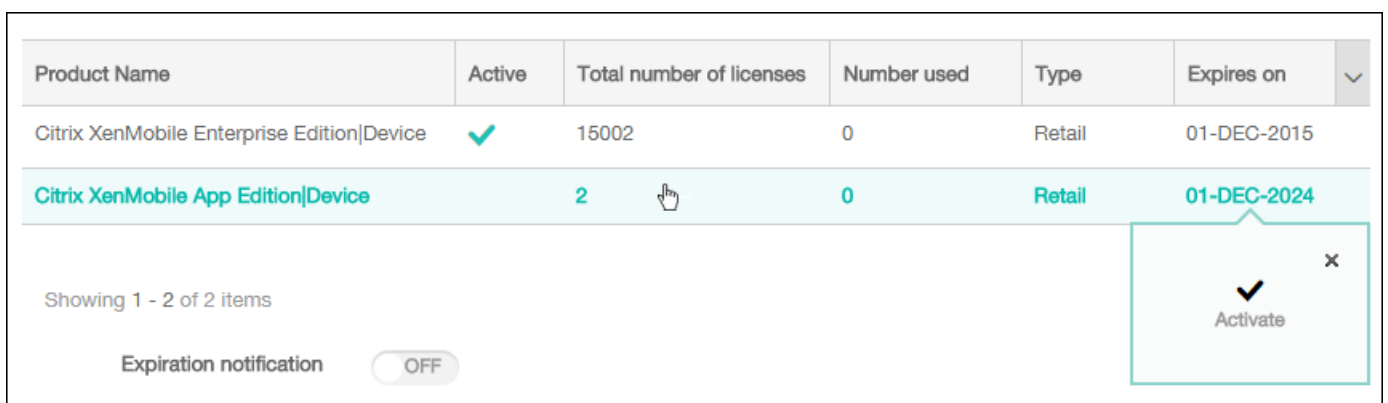

2. Click **Activate**. The **Activate** dialog box appears.

3. Click **Activate**. The selected license is activated.

Important

If you activate the selected license, the currently active license is deactivated.

To automate an expiration notification

After you have activated remote or local licenses, you can configure XenMobile to notify you or a designate when the license expiration date approaches.

1. On the **Licensing** page, set **Expiration notification** to **On**. New notification-related fields appear.

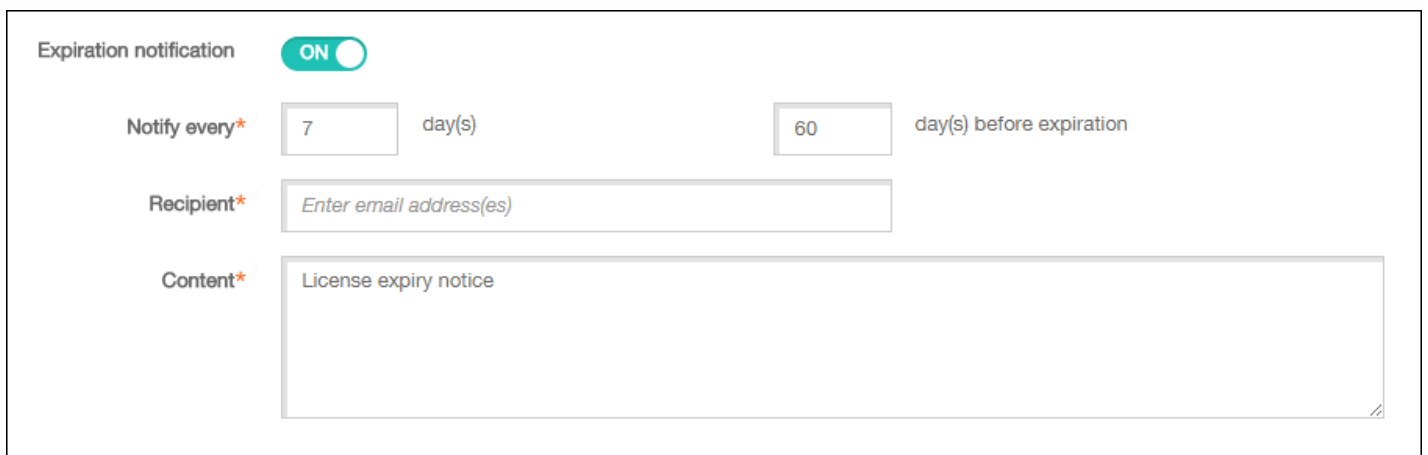

The screenshot shows the 'Expiration notification' configuration interface. At the top, there is a toggle switch labeled 'Expiration notification' which is currently turned 'ON'. Below this, there are three main fields:

- Notify every***: A text input field containing the number '7', followed by the text 'day(s)'. To its right is another text input field containing the number '60', followed by the text 'day(s) before expiration'.
- Recipient***: A text input field with the placeholder text 'Enter email address(es)'.
- Content***: A large text area containing the text 'License expiry notice'.

2. Configure these settings:

- **Notify every:** Type:
 - The frequency with which the notifications are sent, such as every **7** days.
 - When to begin sending the notification, such as 60 days before the license expires.
- **Recipient:** Type your email address or the email address of the person responsible for the license.
- **Content:** Type an expiration notification message that the recipient sees in the notification.

3. Click **Save**. Based on your settings, XenMobile begins sending email messages containing the text you typed in **Content** to the recipient you typed in **Recipient**. The notifications are sent with the frequency you set.

FIPS 140-2 compliance

Jun 19, 2017

The Federal Information Processing Standard (FIPS), issued by the US National Institute of Standards and Technologies (NIST), specifies the security requirements for cryptographic modules used in security systems. FIPS 140-2 is the second version of this standard. For more information about NIST-validated FIPS 140 modules, see <http://csrc.nist.gov/groups/STM/cmvp/documents/140-1/140sp/140sp1747.pdf>.

Important: FIPS support is available only for on-premises installations of XenMobile Server. You can enable XenMobile FIPS mode only during initial installation.

Note: XenMobile mobile device management-only, XenMobile mobile app management-only, and XenMobile Enterprise are all FIPS compliant as long as no HDX apps are used.

All data-at-rest and data-in-transit cryptographic operations on iOS use FIPS-certified cryptographic modules provided by the OpenSSL and Apple. On Android, all data-at-rest cryptographic operations and all data-in-transit cryptographic operations from the mobile device to NetScaler Gateway use FIPS-certified cryptographic modules provided by OpenSSL.

All data-at-rest and data-in-transit cryptographic operations for Mobile Device Management (MDM) on supported Windows devices use FIPS-certified cryptographic modules provided by Microsoft.

All data-at-rest and data-in-transit cryptographic operations at XenMobile Device Manager use FIPS-certified cryptographic modules provided by OpenSSL. Combined with the cryptographic operations described above for mobile devices, and between mobile devices and NetScaler Gateway, all data-at-rest and data-in-transit for MDM flows use FIPS-compliant cryptographic modules end-to-end.

All data-in-transit cryptographic operations between iOS, Android, and Windows mobile devices and NetScaler Gateway use FIPS-certified cryptographic modules. XenMobile uses a DMZ-hosted NetScaler FIPS Edition appliance equipped with a certified FIPS module to secure these data. For more information, see the NetScaler [FIPS](#) documentation.

MDX apps are supported on Windows Phone and use cryptographic libraries and APIs that are FIPS-compliant on Windows Phone. All data-at-rest for MDX apps on Windows Phone and all data-in-transit between the Windows Phone device and NetScaler Gateway are encrypted using these libraries and APIs.

The MDX Vault encrypts MDX-wrapped apps and associated data-at-rest on both iOS and Android devices using FIPS-certified cryptographic modules provided by the OpenSSL.

For the full XenMobile FIPS 140-2 compliance statement, including the specific modules used in each case, contact your Citrix representative.

Language support

Jun 19, 2017

XenMobile Apps and the XenMobile console are adapted for use in languages other than English. The support includes non-English characters and keyboard input even when the app is not localized in the preferred language of a user. For more information about globalization support for all Citrix products, see <http://support.citrix.com/article/CTX119253>.

This article lists the supported languages in the latest release of XenMobile.

XenMobile console and the Self Help Portal

- French
- German
- Japanese
- Korean
- Portuguese
- Simplified Chinese

XenMobile Apps

An X indicates that the app is available in that particular language. The Secure Forms app is currently available in English only.

Note: As of the release of version 10.4, Worx Mobile Apps are renamed to XenMobile Apps. Most of the individual XenMobile Apps are also renamed. For details, see [About XenMobile Apps](#).

iOS and Android

	Secure Hub	Secure Mail	Secure Web	Secure Notes	Secure Tasks	QuickEdit
Japanese	X	X	X	X	X	X
Simplified Chinese	X	X	X	X	X	X
Traditional Chinese	X	X	X	X	X	X
French	X	X	X	X	X	X
German	X	X	X	X	X	X
Spanish	X	X	X	X	X	X
Korean	X	X	X	X	X	X

Portuguese	X	X	X	X	X	X
Dutch	X	X	X	X	X	X
Italian	X	X	X	X	X	X
Danish	X	X	X	X	X	X
Swedish	X	X	X	X	X	X
Hebrew	X	X	X	X	X	iOS only
Arabic	X	X	X	X	X	X
Russian	X	X	X	X	X	X
Turkish	X	X	Android only			

Windows

	Secure Hub	Secure Mail	Secure Web
French	X	X	X
German	X	X	X
Spanish	X	X	X
Italian	X	X	X
Danish	X	X	X
Swedish	X	X	X

Right-to-left language support

The following table summarizes support for text in Middle Eastern languages for each app. An X indicates that the feature is available for that platform. Right-to-left language support is not available for Windows devices.

	iOS	Android
Secure Hub	X	X
Secure Mail	X	X
Secure Web	X	X
Secure Tasks	X	X
Secure Notes	X	X
QuickEdit	X	X

Install and configure

Jun 19, 2017

Before you start:

You can use the following preinstallation checklist to note the prerequisites and settings for installing XenMobile. Each task or note includes a column indicating the component or function for which the requirement applies.

Planning a XenMobile deployment involves many considerations. For recommendations, common questions, and use cases for your end-to-end XenMobile environment, see the [XenMobile Deployment Handbook](#).

For installation steps, see the [Install XenMobile](#) section later in this article.

Preinstallation checklist

Basic Network Connectivity

The following are the network settings you need for the XenMobile solution.

 Prerequisite or setting	Component or function	Note the setting
Note the fully qualified domain name (FQDN) to which remote users connect.	XenMobile NetScaler Gateway	
Note the public and local IP address. You need these IP addresses to configure the firewall to set up network address translation (NAT).	XenMobile NetScaler Gateway	
Note the subnet mask.	XenMobile NetScaler Gateway	
Note the DNS IP addresses.	XenMobile NetScaler Gateway	
Write down the WINS server IP addresses (if applicable).	NetScaler Gateway	

<p>Identify and write down the NetScaler Gateway host name.</p> <p>Note: This is not the FQDN. The FQDN is contained in the signed server certificate that is bound to the virtual server and to which users connect. You can configure the host name by using the Setup Wizard in NetScaler Gateway.</p>	<p>NetScaler Gateway</p>	
<p>Note the IP address of XenMobile.</p> <p>Reserve one IP address if you install one instance of XenMobile.</p> <p>If you configure a cluster, note all of the IP addresses you need.</p>	<p>XenMobile</p>	
<ul style="list-style-type: none"> • One public IP address configured on NetScaler Gateway • One external DNS entry for NetScaler Gateway 	<p>NetScaler Gateway</p>	
<p>Note the web proxy server IP address, port, proxy host list, and the administrator user name and password. These settings are optional if you deploy a proxy server in your network (if applicable).</p> <p>Note: You can use either the sAMAccountName or the User Principal Name (UPN) when configuring the user name for the web proxy.</p>	<p>XenMobile</p> <p>NetScaler Gateway</p>	
<p>Note the default gateway IP address.</p>	<p>XenMobile</p> <p>NetScaler Gateway</p>	
<p>Note the system IP (NSIP) address and subnet mask.</p>	<p>NetScaler Gateway</p>	
<p>Note the subnet IP (SNIP) address and subnet mask.</p>	<p>NetScaler Gateway</p>	
<p>Note the NetScaler Gateway virtual server IP address and FQDN from the certificate.</p> <p>If you need to configure multiple virtual servers, note all of the virtual IP addresses and FQDNs from the certificates.</p>	<p>NetScaler Gateway</p>	
<p>Note the internal networks that users can access through NetScaler Gateway.</p> <p>Example: 10.10.0.0/24</p> <p>Enter all internal networks and network segments that users need access to when they connect with Secure Hub or the NetScaler Gateway Plug-in when split tunneling is set to On.</p>	<p>NetScaler Gateway</p>	

	Make sure that the network connectivity between the XenMobile server, NetScaler Gateway, the external Microsoft SQL Server, and the DNS server are reachable.	XenMobile NetScaler Gateway	
--	---	-----------------------------------	--

Licensing

XenMobile requires you to purchase licensing options for NetScaler Gateway and XenMobile. For more information about Citrix Licensing, see [The Citrix Licensing System](#).

	Prerequisite	Component	Note the location
	Obtain Universal licenses from the Citrix web site . For details, see Licensing in the NetScaler Gateway documentation.	NetScaler Gateway XenMobile Citrix License Server	

Certificates

XenMobile and NetScaler Gateway require certificates to enable connections with other Citrix products and app and from user devices. For details, see the [Certificates and Authentication](#) section in the XenMobile documentation.

	Prerequisite	Component	Notes
	Obtain and install required certificates.	XenMobile NetScaler Gateway	

Ports

You need to open ports to allow communication with the XenMobile components.

	Prerequisite	Component	Notes
	Open ports for XenMobile	XenMobile NetScaler Gateway	

Database

You need to configure a database connection. The XenMobile repository requires a Microsoft SQL Server database running on one of the following supported versions: Microsoft SQL Server 2014, SQL Server 2012, SQL Server 2008 R2, or SQL Server 2008. Citrix recommends using Microsoft SQL remotely. PostgreSQL is included with XenMobile and should be used locally

or remotely only in test environments.

✓	Prerequisite	Component	Note the setting
	<p>Microsoft SQL Server IP address and port.</p> <p>Make sure the service account of the SQL Server to be used on XenMobile has the DBcreator role permission.</p>	XenMobile	

Active Directory Settings

✓	Prerequisite	Component	Note the setting
	<p>Note the Active Directory IP address and port for the primary and secondary servers.</p> <p>If you use port 636, install a root certificate from a CA on XenMobile, and change the Use secure connections option to Yes.</p>	<p>XenMobile</p> <p>NetScaler Gateway</p>	
	<p>Note the Active Directory domain name.</p>	<p>XenMobile</p> <p>NetScaler Gateway</p>	
	<p>Note the Active Directory service account, which requires a user ID, password, and domain alias.</p> <p>The Active Directory service account is the account that XenMobile uses to query Active Directory.</p>	<p>XenMobile</p> <p>NetScaler Gateway</p>	
	<p>Note the User Base DN.</p> <p>This is the directory level under which users are located; for example, cn=users,dc=ace,dc=com. NetScaler Gateway and XenMobile use this to query Active Directory.</p>	<p>XenMobile</p> <p>NetScaler Gateway</p>	
	<p>Note the Group Base DN.</p> <p>This is the directory level under which groups are located.</p> <p>NetScaler Gateway and XenMobile use this to query Active Directory.</p>	<p>XenMobile</p> <p>NetScaler Gateway</p>	

Connections between XenMobile and NetScaler Gateway

✓	Prerequisite	Component	Note the setting
---	--------------	-----------	------------------

	Note the XenMobile host name.	XenMobile	
	Note the FQDN or IP address of XenMobile.	XenMobile	
	Identify the apps users can access.	NetScaler Gateway	
	Note the Callback URL.	XenMobile	

User Connections: Access to XenDesktop, XenApp, and Citrix Secure Hub

Citrix recommends that you use the Quick Configuration wizard in NetScaler to configure connection settings between XenMobile and NetScaler Gateway and between XenMobile and Secure Hub. You create a second virtual server to enable user connections from Citrix Receiver and web browsers to connect to Windows-based applications and virtual desktops in XenApp and XenDesktop. Citrix recommends that you use the Quick Configuration wizard in NetScaler to configure these settings as well.

	Prerequisite	Component	Note the setting
	Note the NetScaler Gateway host name and external URL. The external URL is the web address with which users connect.	XenMobile	
	Note the NetScaler Gateway callback URL.	XenMobile	
	Note the IP addresses and subnets masks for the virtual server.	NetScaler Gateway	
	Note the path for Program Neighborhood Agent or a XenApp Services site.	NetScaler Gateway XenMobile	
	Note the FQDN or IP address of the XenApp or XenDesktop server running the Secure Ticket Authority (STA) (for ICA connections only).	NetScaler Gateway	
	Note the public FQDN for XenMobile.	NetScaler Gateway	
	Note the public FQDN for Secure Hub.	NetScaler Gateway	

Flowchart for XenMobile deployment

You can use this flowchart to guide you through the main steps for deploying XenMobile. Links to topics on each step follow the figure.

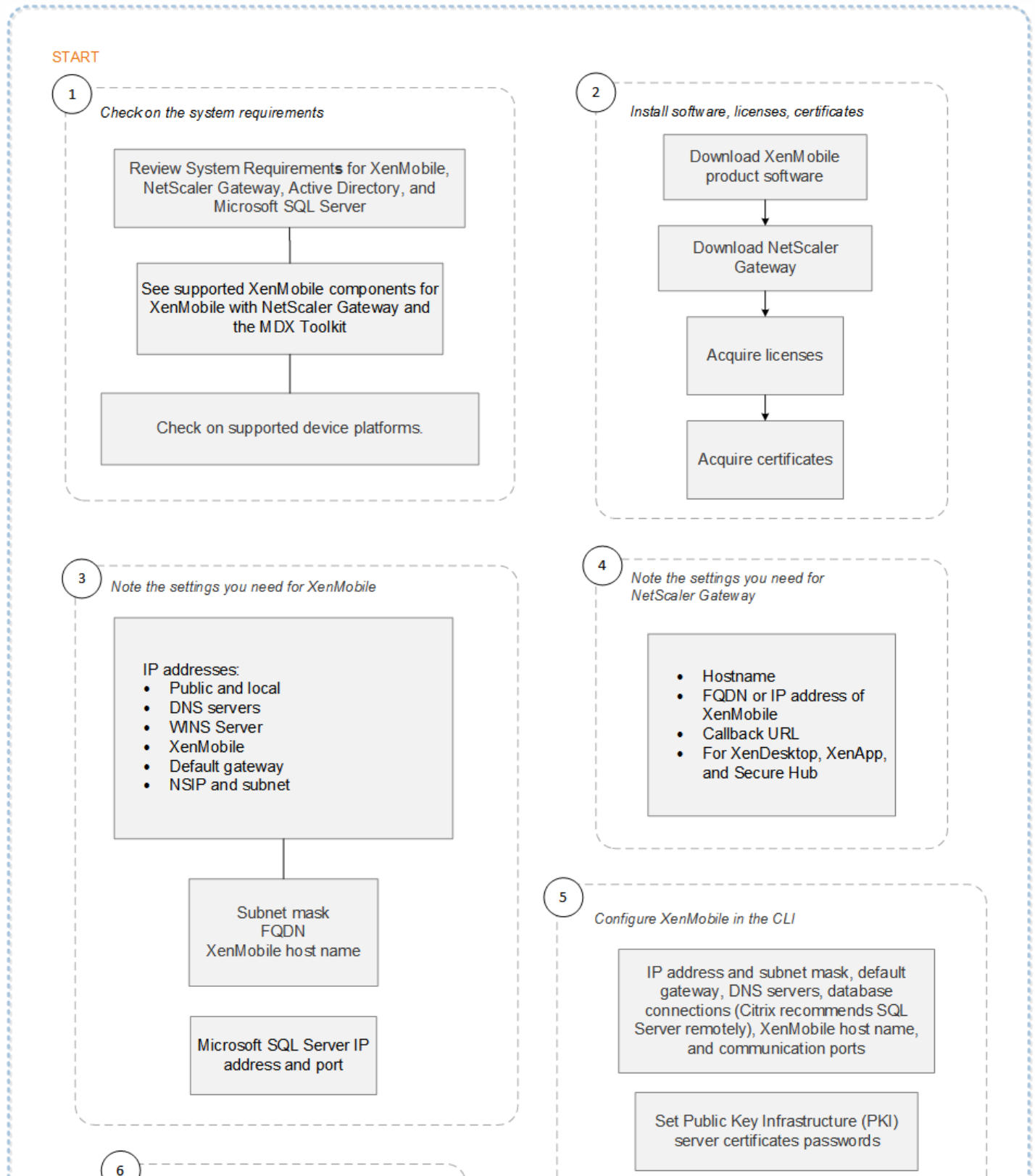

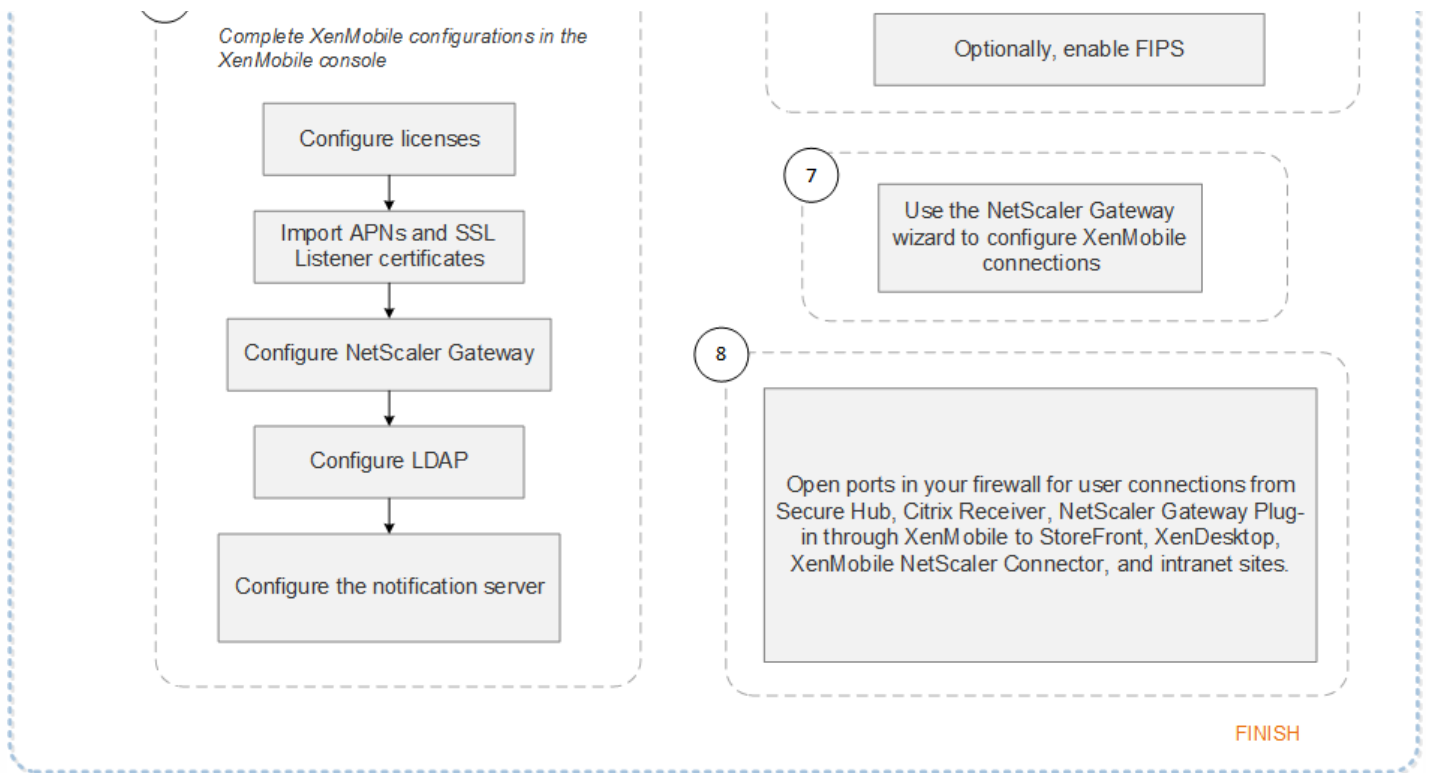

- 1: [System requirements and compatibility](#)
- 2: [Install and configure](#)
- 3 and 4: [Preinstallation checklist \(this article\)](#)
- 5: [Configure XenMobile in the Command Prompt Window \(this article\)](#)
- 6: [Configure XenMobile in a web browser \(this article\)](#)
- 7: [Configuring Settings for Your XenMobile Environment](#)
- 8: [Port requirements](#)

The flowchart is also available in PDF format.

[PDF](#) [Flowchart for Deploying XenMobile](#)

Install XenMobile

The XenMobile virtual machine (VM) runs on Citrix XenServer, VMware ESXi, or Microsoft Hyper-V. You can use XenCenter or vSphere management consoles to install XenMobile.

Note

Ensure that the hypervisor is configured with the correct time – either using an NTP server or a manual configuration - because XenMobile uses that time.

XenServer or VMware ESXi prerequisites: Before installing XenMobile on XenServer or VMware ESXi, you must do the following. For details, refer to your [XenServer](#) or [VMware](#) documentation.

- Install XenServer or VMware ESXi on a computer with adequate hardware resources.
- Install XenCenter or vSphere on a separate computer. The computer that hosts XenCenter or vSphere connects to the XenServer or VMware ESXi host through the network.

Hyper-V prerequisites: Before installing XenMobile on Hyper-V, you must do the following. For details, refer to your [Hyper-V](#) documentation.

- Install Windows Server 2008 R2, Windows Server 2012, or Windows Server 2012 R2 with Hyper-V enabled, role enabled, on a computer with adequate system resources. While installing the Hyper-V role, be sure to specify the network interface cards (NICs) on the server that Hyper-V will use to create the virtual networks. You can reserve some NICs for the host.
- Delete the file Virtual Machines/<build-specific UUID>.xml
- Move the file Legacy/<build-specific UUID>.exp into Virtual Machines

If you install Windows Server 2008 R2 or Windows Server 2012, do the following:

These steps are necessary because there are two different versions of the Hyper-V manifest file representing the VM configuration (.exp and .xml). The Windows Server 2008 R2 and Windows Server 2012 releases support only .exp. For these releases, you must have only the .exp manifest file in place before installation.

Windows Server 2012 R2 does not require these extra steps.

FIPS 140-2 mode: If you plan to install XenMobile server in FIPS mode, you need to complete a set of prerequisites, as discussed in [Configuring FIPs](#).

Download XenMobile product software

You can download product software from the [Citrix web site](#). You need to log on to the site first and then use the Downloads link on the Citrix web page to navigate to the page containing the software you want to download.

To download the software for XenMobile

1. Go to the [Citrix web site](#).
2. Next to the Search box, click Log On and log on to your account.
3. Click the Downloads tab.
4. On the Downloads page, from the select product list, click XenMobile.

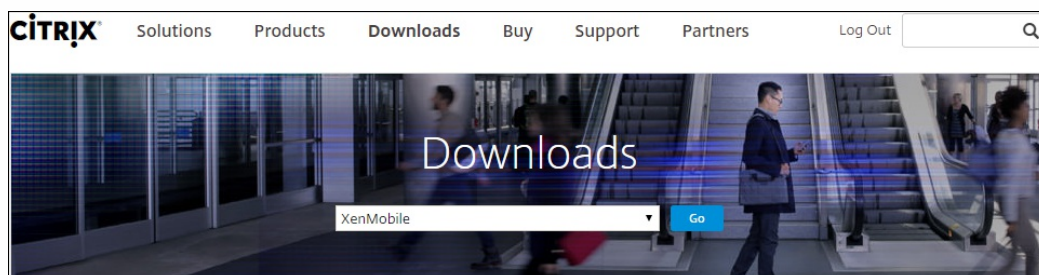

5. Click **Go**. The XenMobile page appears.
6. Expand **XenMobile Server**.
7. Expand **Product Software**.
8. Click **XenMobile Server 10**.
9. On the XenMobile Server 10 page, click the **Jump to Download** menu and choose the appropriate virtual image to use to install XenMobile on XenServer, VMware, or Hyper-V. Alternatively, scroll down the page to locate the **Download File** button for the image you want to install.
10. Follow the instructions on your screen to download the software.

To download the software for NetScaler Gateway

You can use this procedure to download the NetScaler Gateway virtual appliance or software upgrades to your existing NetScaler Gateway appliance.

1. Go to the [Citrix web site](#).
2. If you are not already logged on to the Citrix web site, next to the Search box, click Log On and log on to your account.
3. Click the Downloads tab.
4. On the Downloads page, from the select product list, click NetScaler Gateway.
5. Click Go. The NetScaler Gateway page appears.
6. On the NetScaler Gateway page, expand the version of NetScaler Gateway you are running.
7. Under Firmware, click the appliance software version you want to download.
Note: You can also click Virtual Appliances to download NetScaler VPX. When you select this option, you receive a list of software for the virtual machine for each hypervisor.
8. Click the appliance software version you want to download.
9. On the appliance software page for the version you want to download, click Download for the appropriate virtual appliance.
10. Follow the instructions on your screen to download the software.

Configure XenMobile for First-Time Use

1. Configure the IP address and subnet mask, default gateway, DNS servers, and so on for XenMobile by using the XenCenter or vSphere command-line console.

Note

When you use a vSphere web client, it is recommended that you do not configure networking properties during the time you deploy the OVF template on the **Customize template** page. By doing so, in a high availability configuration, you avoid an issue with the IP address that occurs when you clone and then restart the second XenMobile virtual machine.

2. Access the XenMobile management console only through the XenMobile Server fully qualified domain name or the IP addresses of the node.
3. Log on and then follow the steps in the initial logon screens.

Configure XenMobile in the Command Prompt Window

1. Import the XenMobile virtual machine into Citrix XenServer, Microsoft Hyper-V, or VMware ESXi. For details, see [XenServer](#), [Hyper-V](#), or [VMware](#) documentation.
2. In your hypervisor, select the imported XenMobile virtual machine and start the command prompt view. For details, see the documentation for your hypervisor.
3. From the hypervisor's console page, create an administrator account for XenMobile in the command prompt window by typing the administrator user name and password.

Important:

When you create or changed passwords for the command prompt administrator account, Public Key Infrastructure (PKI) server certificates, and FIPS, XenMobile enforces the following rules for all users except Active Directory users whose passwords are managed outside of XenMobile:

- The password must be at least 8 characters long and must meet at least three of the following complexity criteria:
 - Uppercase letters (A through Z)
 - Lowercase letters (a through z)
 - Numerals (0 through 9)
 - Special characters (such as !, #, \$, %)

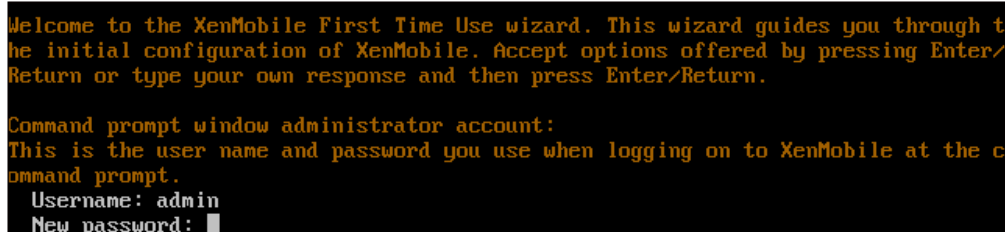

```
Welcome to the XenMobile First Time Use wizard. This wizard guides you through the initial configuration of XenMobile. Accept options offered by pressing Enter/Return or type your own response and then press Enter/Return.

Command prompt window administrator account:
This is the user name and password you use when logging on to XenMobile at the command prompt.
Username: admin
New password: █
```

Note: No characters, such as asterisks, are shown when you type the new password. Nothing appears.

4. Provide the following network information and then, type y to commit the settings:
 1. IP address of the XenMobile server
 2. Netmask
 3. Default gateway, which is the IP address of the default gateway in the DMZ
 4. Primary DNS server, which is the IP address of the DNS server
 5. Secondary DNS server (optional)

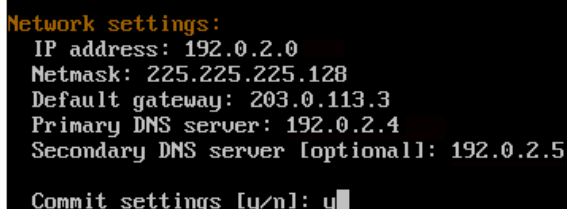

```
Network settings:
IP address: 192.0.2.0
Netmask: 225.225.225.128
Default gateway: 203.0.113.3
Primary DNS server: 192.0.2.4
Secondary DNS server [optional]: 192.0.2.5

Commit settings [y/n]: y█
```

Note: The addresses shown in this and following images are non-working and are provided as examples only.

5. Type y to increase security by generating a random encryption passphrase or n to provide your own passphrase. Citrix recommends typing y to generate a random passphrase. The passphrase is used as part of the protection of the encryption keys used to secure your sensitive data. A hash of the passphrase, stored in the server file system, is used to retrieve the keys during the encryption and decryption of data. The passphrase cannot be viewed.

Note: If you intend to extend your environment and configure additional servers, you should provide your own

passphrase. There is no way to view the passphrase if you selected a random passphrase.

```
Encryption passphrase:  
Generate a random passphrase to secure the server data? [y/n]: y
```

6. Optionally, enable Federal Information Processing Standard (FIPS). For details about FIPS, see [FIPS](#). Also, be sure to complete a set of prerequisites, as discussed in [Configuring FIPS](#).

```
Federal Information Processing Standard (FIPS) mode:  
Enable (y/n) [n]:
```

7. Provide the following information to configure the database connection.

```
Database connection:  
Local or remote [l/r]: r  
Type (Microsoft SQL, PostgreSQL or MySQL) [mi/p/my]: mi  
Use SSL [y/n]: n  
Server: 198.0.2.10  
Port: 5432  
Username: postgres  
Password:
```

1. Your database can be local or remote. Type l for local or r for remote.
2. Select the database type. Type mi for Microsoft SQL or type p for PostgreSQL.
Important:
 - Citrix recommends using Microsoft SQL remotely. PostgreSQL is included with XenMobile and should be used locally or remotely only in test environments.
 - Database migration is not supported. Databases created in a test environment cannot be moved to a production environment.
3. Optionally, type y to use SSL authentication for your database.
4. Provide the fully qualified domain name (FQDN) for the server hosting XenMobile. This one host server provides both device management and app management services.
5. Type your database port number if it is different from the default port number. The default port for Microsoft SQL is 1433 and the default port for PostgreSQL is 5432.
6. Type your database administrator user name.
7. Type your database administrator password.
8. Type the database name.
9. Press **Enter** to commit the database settings.
8. Optionally, type y to enable clustering XenMobile nodes, or instances.
Important: If you enable a XenMobile cluster, after system configuration is complete, be sure to open port 80 to enable real time communication between cluster members. This must be completed on all cluster nodes.
9. Type the XenMobile server fully qualified domain name (FQDN).

```
XenMobile hostname:  
Hostname: justan.example.com
```

10. Press **Enter** to commit the settings.
11. Identify the communication ports. For details on ports and their uses, see [Port Requirements](#).

Note: Accept the default ports by pressing **Enter** (Return on a Mac).

```
HTTP [80]: 80
HTTPS with certificate authentication [443]: 443
HTTPS with no certificate authentication [8443]: 8443
HTTPS for management [4443]: 4443
```

12. Skip the next question about upgrading from a previous XenMobile release because you are installing XenMobile for the first time.
13. Type y if you want to use the same password for each Public Key Infrastructure (PKI) certificate. For details on the XenMobile PKI feature, see [Uploading Certificates](#).

```
The wizard will now generate an internal Public Key Infrastructure (PKI):
- A root certificate
- An intermediate certificate to issue device certificates during enrollment
- An intermediate certificate to issue an SSL certificate
- An SSL certificate for your connectors
Do you want to use the same password for all the certificates of the PKI [y]:
New password:
Re-enter new password:
```

Important: If you intend to cluster nodes, or instances, of XenMobile together, you must provide the identical passwords for subsequent nodes.

14. Type the new password and then, re-enter the new password to confirm it.
Note: No characters, such as asterisks, are shown when you type the new password. Nothing appears.
15. Press **Enter** to commit the settings.
16. Create an administrator account for logging on to the XenMobile console with a web browser. Be sure to remember these credentials for later use.

```
XenMobile console administrator account:
This is the user name and password you use when logging on to the XenMobile console through a web browser.
Username [administrator]: administrator
Password:
Re-enter new password:
```

Note: No characters, such as asterisks, are shown when you type the new password. Nothing appears.

17. Press **Enter** to commit the settings. The initial system configuration is saved.
18. When asked if this is an upgrade, type n because it is a new installation.
19. Copy the complete URL that appears on the screen and continue this initial XenMobile configuration in your web browser.

```
Writing iptables configuration...
Restarting iptables...

Initial system configuration complete!

Upgrade:
Upgrade from previous release (y/n) [n]:

Stopping configuration app... [ OK ]
Starting configuration app...
  application started successfully [ OK ]
Stopping main app... [ OK ]
Starting main app...
  this may take a few minutes.....
.....
  application started successfully [ OK ]

To access the console, from a web browser, go to the following location and
log on with your console credentials:
https://203.0.113.8:4443/

Starting monitoring... [ OK ]
```

Configure XenMobile in a web browser

After completing the initial portion of the XenMobile configuration in your hypervisor command prompt window, complete the process in your web browser.

1. In your web browser, navigate to the location provided at the conclusion of the command prompt window configuration.
2. Type the XenMobile console administrator account user name and password you created in the command prompt window.

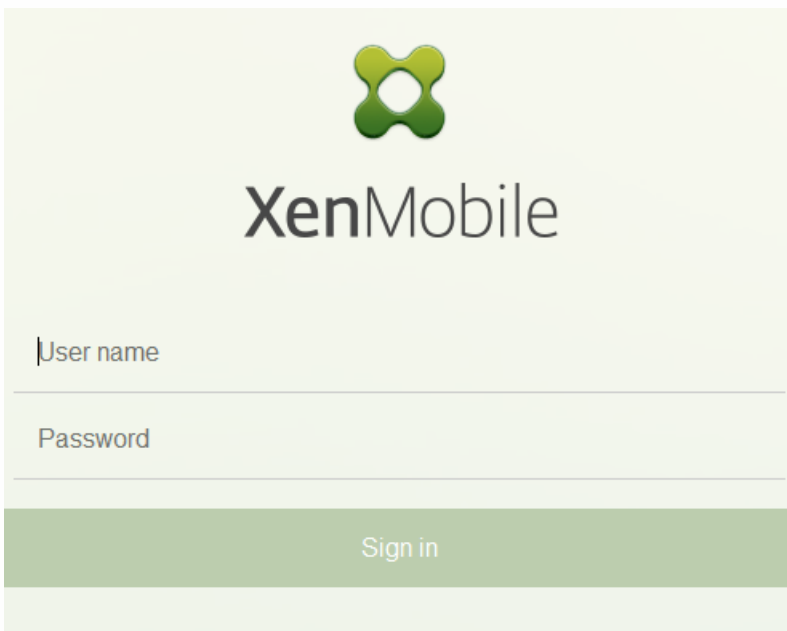

3. On the Get Started page, click Start. The Licensing page appears.
4. Configure the license. If you don't upload a license, you use an evaluation license valid for 30 days. For details on adding and configuring licenses and configuring expiration notifications, see [Licensing](#).

Important: If you intend to use XenMobile clustering by adding cluster nodes, or instances, of XenMobile, you need to use the Citrix Licensing on a remote server.

5. On the Certificate page, click Import. The Import dialog box appears.

6. Import your APNs and SSL Listener certificate. If you manage iOS devices, you need an APNs certificate. For details on working with certificates, see [Certificates](#).

Note: This step requires restarting the server.

7. If appropriate to the environment, configure NetScaler Gateway. For details on configuring NetScaler Gateway, see [NetScaler Gateway and XenMobile](#) and [Configuring Settings for Your XenMobile Environment](#).

Note:

- You can deploy NetScaler Gateway at the perimeter of your organization's internal network (or intranet) to provide a secure single point of access to the servers, applications, and other network resources that reside in the internal network. In this deployment, all remote users must connect to NetScaler Gateway before they can access any resources in the internal network.
- Although NetScaler Gateway is an optional setting, after you enter data on the page, you must clear or complete the required fields before you can leave the page.

8. Complete the LDAP configuration to access users and groups from Active Directory. For details on configuring the LDAP connection, see [LDAP Configuration](#).

9. Configure the notification server to be able to send messages to users. For details on notification server configuration, see [Notifications](#).

Post-requisite: Restart the XenMobile server to activate your certificates.

Configure FIPS with XenMobile

Aug 24, 2017

Federal Information Processing Standards (FIPS) mode in XenMobile supports U.S. federal government customers by configuring the server to use only FIPS 140-2 certified libraries for all encryption operations. Installing your XenMobile server with FIPS mode ensures that all data at rest and data in transit for both the XenMobile client and server are fully compliant with FIPS 140-2.

Before installing a XenMobile Server in FIPS mode, you need to complete the following prerequisites.

- You must use an external SQL Server 2012 or SQL Server 2014 for the XenMobile database. The SQL Server also must be configured for secure SSL communication. For instructions on configuring secure SSL communication to SQL Server, see the [SQL Server Books Online](#).
- Secure SSL communication requires that an SSL certificate be installed on your SQL Server. The SSL certificate can either be a public certificate from a commercial CA or a self-signed certificate from an internal CA. Note that SQL Server 2014 cannot accept a wildcard certificate. Citrix recommends, therefore, that you request an SSL certificate with the FQDN of the SQL Server.
- If you use a self-signed certificate for SQL Server, you will need a copy of the root CA certificate that issued your self-signed certificate. The root CA certificate must be imported to the XenMobile server during installation.

Configuring FIPS mode

You can enable FIPS mode only during the initial setup of XenMobile server. It is not possible to enable FIPS after installation is complete. Therefore, if you plan on using FIPS mode, you must install the XenMobile server with FIPS mode from the start. In addition, if you have a XenMobile cluster, all cluster nodes must have FIPS enabled; you cannot have a mix of FIPS and non-FIPS XenMobile servers in the same cluster.

There is a **Toggle FIPS mode** option in the XenMobile command-line interface that is not for production use. This option is intended for non-production, diagnostic use and is not supported on a production XenMobile server.

1. During initial setup, enable **FIPS mode**.
2. Upload the root CA certificate for your SQL Server. If you used a self-signed SSL certificate rather than a public certificate on your SQL Server, choose **Yes** for this option and then do one of the following:
 - a. Copy and paste the CA certificate.
 - b. Import the CA certificate. To import the CA certificate, you must post the certificate to a website that is accessible from the XenMobile server via an HTTP URL. For details, see [Uploading the certificate to XenMobile](#).
3. Specify the server name and port of your SQL Server, the credentials for logging into SQL Server, and the database name to create for XenMobile.

Note: You can use either a SQL logon or an Active Directory account to access SQL Server, but the logon you use must have the DBcreator role.
4. To use an Active Directory account, enter the credentials in the format domain\username.
5. Once these steps are complete, proceed with the XenMobile initial setup.

To confirm that the configuration of FIPS mode is successful, log on to the XenMobile command-line interface. The phrase **In FIPS Compliant Mode** appears in the logon banner.

Importing Certificates

The following procedure describes how to configure FIPS on XenMobile by importing the certificate, which is required when you use a VMware hypervisor.

SQL Prerequisites

1. The connection to the SQL instance from XenMobile needs to be secure and must be SQL Server version 2012 or SQL Server 2014. To secure the connection, see [How to enable SSL encryption for an instance of SQL Server by using Microsoft Management Console](#).
2. If the service does not restart properly, check the following:Open **Services.msc**.
 - a. Copy the logon account information used for the SQL Server service.
 - b. Open MMC.exe on the SQL Server.
 - c. Go to **File > Add/Remove Snap-in** and then double-click the certificates item to add the certificates snap-in. Select the computer account and local computer in the two pages on the wizard.
 - d. Click **OK**.
 - e. Expand **Certificates (Local Computer) > Personal > Certificates** and find the imported SSL certificate.
 - f. Right-click the imported certificate (selected in the SQL Server Configuration Manager) and then click **All Tasks > Manage Private Keys**.
 - g. Under **Group or User names**, click **Add**.
 - h. Enter the SQL service account name you copied in the earlier step.
 - i. Clear the **Allow Full Control** option. By default the service account will be given both Full control and Read permissions, but it only needs to be able to read the private key.
 - j. Close **MMC** and start the SQL service.
3. Ensure the SQL service is started correctly.

Internet Information Services (IIS) Prerequisites

1. Download the rootcert (base 64).
2. Copy the rootcert to the default site on the IIS server, C:\inetpub\wwwroot.
3. Check the **Authentication** check box for the default site.
4. Set **Anonymous** to **enabled**.
5. Select the **Failed Request Tracking** rules check box.
6. Ensure that .cer is not blocked.

7. Browse to the location of the .cer in an Internet Explorer browser from the local server, <http://localhost/certname.cer>. The root cert text should appear in the browser.

8. If the root cert does not appear in the Internet Explorer browser, make sure that ASP is enabled on the IIS server as follows.

- a. Open Server Manager.
- b. Navigate to the wizard in **Manage > Add Roles and Features**.
- c. In the server roles, expand **Web Server (IIS)**, expand **Web Server**, expand **Application Development** and then select **ASP**.
- d. Click **Next** until the install completes.

9. Open Internet Explorer and browse to <http://localhost/cert.cer>.

For more information, see [Web Server \(IIS\)](#).

Note

You can use the use the IIS instance of the CA for this procedure.

Importing the Root Certificate During Initial FIPS Configuration

When you complete the steps to configure XenMobile for the first time in the command-line console, you must complete these settings to import the root certificate. For details on the installation steps, see [Installing XenMobile](#).

- Enable FIPS: Yes
- Upload Root Certificate: Yes
- Copy(c) or Import(i): i
- Enter HTTP URL to import: <http://FQDN of IIS server/cert.cer>
- Server: *FQDN of SQL Server*
- Port: 1433
- User name: Service account which has the ability to create the database (domain\username).
- Password: The password for the service account.
- Database Name: This is a name you choose.

Enable FIPS mode for mobile devices

By default, FIPS mode is disabled on mobile devices. To enable FIPS mode, go to **Settings > Client Properties**, edit the **Enable FIPS Mode** property, and set the value to **true**. For more information, see [Client properties](#).

Configure clustering

Jun 19, 2017

In XenMobile versions earlier than version 10, you configured Device Manager as a cluster and App Controller as a high availability pair. XenMobile 10 integrated XenMobile 9 Device Manager and App Controller. As of version 10, high availability is no longer applicable to XenMobile. To configure clustering, therefore, you need to configure the following two load balancing virtual IP addresses on NetScaler:

- **Mobile device management (MDM) load balancing virtual IP address:** An MDM load balancing virtual IP address is required to communicate with the XenMobile nodes that are configured in a cluster. This load balancing is done in SSL Bridge mode.
- **Mobile app management (MAM) load balancing virtual IP address:** MAM load balancing virtual IP addresses are required for NetScaler Gateway to communicate with XenMobile nodes that are configured in a cluster. In XenMobile 10, by default, all traffic from NetScaler Gateway routes to the load balancing virtual IP address on port 8443.

The procedures in this article explain the method of creating a new XenMobile virtual machine (VM) and joining the new VM to an existing VM, thereby creating a cluster setup.

Prerequisites

- You have fully configured the required XenMobile node.
- One public IP address for MDM load balancer and one private IP address for MAM.
- Server certificates.
- One free IP for NetScaler Gateway virtual IP address.

For reference architectural diagrams for XenMobile 10.x in clustered configurations, see [Architecture](#).

Installing the XenMobile Cluster Nodes

Based on the number of nodes you require, you create new XenMobile VMs. You point the new VMs to the same database and provide the same PKI certificate passwords.

1. Open the command-line console of the new VM and enter the new password for the administrator account.

```
*****
*           Citrix XenMobile           *
*   (in First Time Use mode)         *
*****

Welcome to the XenMobile First Time Use wizard. This wizard guides you through t
he initial configuration of XenMobile. Accept options offered by pressing Enter/
Return or type your own response and then press Enter/Return.

Command prompt window administrator account:
This is the user name and password you use when logging on to XenMobile at the c
ommand prompt.
Username: admin
New password:
Re-enter new password: _
```

2. Provide the network configuration details as shown in the following figure.

```

Network settings:
IP address []: 10.147.75.51
Netmask []: 255.255.255.0
Default gateway []: 10.147.75.1
Primary DNS server []: 10.147.75.240
Secondary DNS server (optional) []:

Commit settings (y/n) [y]:
Applying network settings...
eth0: intr type 3, mode 0, 3 vectors allocated
eth0: NIC Link is Up 10000 Mbps

```

3. If you want to use the default password for data protection, type y; or, type n and enter a new password.

```

Encryption passphrase:
Generate a random passphrase to secure the server data (y/n) [y]:

```

4. If you want to use FIPS, type y; or, type n.

```

Federal Information Processing Standard (FIPS) mode:
Enable (y/n) [n]:

```

5. Configure the database so that you point to same database that the earlier fully configured VM pointed to. You will see the message: Database already exists.

```

Database connection:
Local or remote (l/r) [r]:
Type (mi=Microsoft SQL, p=PostgreSQL) [mi]:
Use SSL (y/n) [n]:

Server []: sql2012.wg.lab
Port [1433]:
Username [sa]:
Password:
Database name [DB_service1]: DB_51

Commit settings (y/n) [y]:

Checking database status...
Database already exists.
to enable realtime communication between cluster members please open port 88 us
ing Firewall menu option in CLI menu once the system configuration is complete

Saving server and client certificate passwords..

```

6. Enter the same passwords for the certificates that you provided for the first VM.

```
Database connection:
Local or remote (l/r) [r]:
Type (mi=Microsoft SQL, p=PostgreSQL) [mi]:
Use SSL (y/n) [n]:

Server [l]: sql2012.wg.lab
Port [1433]:
Username [sa]:
Password:
Database name [DB_service]: DB_51

Commit settings (y/n) [y]:

Checking database status...
Database already exists.
To enable realtime communication between cluster members please open port 80 using Firewall menu option in CLI menu once the system configuration is complete

Saving server and client certificate passwords..

WARNING: Please enter the same passwords used to generate internal Public Key Infrastructure (PKI) in first node
Do you want to use the same password for all the certificates of the PKI [y]:
```

After you have entered the password, the initial configuration on second node will complete.

```
Saving server and client certificate passwords..

WARNING: Please enter the same passwords used to generate internal Public Key Infrastructure (PKI) in first node
Do you want to use the same password for all the certificates of the PKI [y]:
y
New password:
Re-enter new password:
Saving server and client certs password...

Applying port listener configuration...
Applying firewall settings ...
Writing iptables configuration...
Restarting iptables...

Initial system configuration complete!
Stopping configuration app... [ OK ]
Starting configuration app...
this may take a few seconds..... [ OK ]
application started [ OK ]
Stopping main app... [ OK ]
Starting main app...
this may take a few minutes....._
```

7. When the configuration is complete, the server restarts and the logon dialog box appears.

```

Applying port listener configuration...
Applying firewall settings ...
Writing iptables configuration...
Restarting iptables...

Initial system configuration complete!
Stopping configuration app... [ OK ]
Starting configuration app...
  this may take a few seconds.....
  application started [ OK ]
Stopping main app... [ OK ]
Starting main app...
  this may take a few minutes.....^ [ .....
.....
  application started [ OK ]

To access the console, from a web browser, go to the following location and
log on with your console credentials:
  https://10.147.75.59:4443/

Starting monitoring... [ OK ]
xms51.wg.lab login:

```

Note: The logon dialog box is identical to the logon dialog box of the first VM. The match is a way for you to confirm that both VMs are using the same database server.

8. Use the fully qualified domain name (FQDN) of XenMobile to open the XenMobile console in a web browser.
9. In the XenMobile console, click the wrench icon in the upper-right corner of the console.

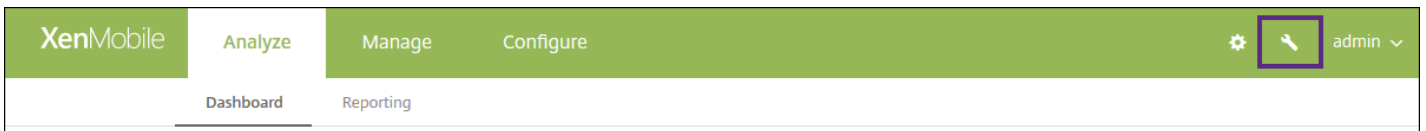

The **Support** page opens.

10. Under **Advanced**, click **Cluster Information**.

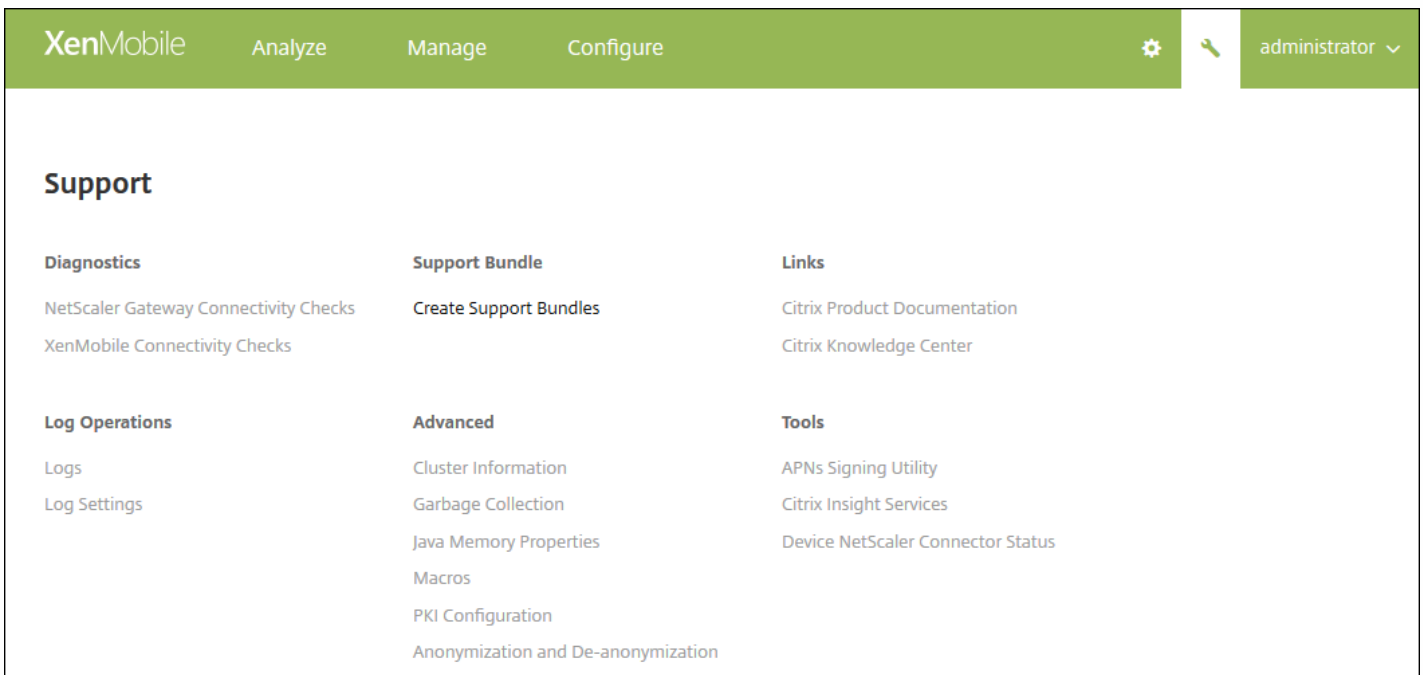

All of the information about the cluster, including cluster member, device connection information, tasks, and so on, appear. The new node is now a member of the cluster.

Support > Cluster Information

Cluster Information

Provides information about each of the nodes in the cluster.

▼ Cluster Members

Node ID	Node name	Status	Role	First check-in	Next check-in
17742s211		ACTIVE	null	2015-04-22 14:40:34.877	2015-04-22 01:02:06.293
17742s203		ACTIVE	OLDEST	2015-04-22 14:30:08.47	2015-04-22 02:09:02.61

Showing 1 - 2 of 2 items

You can add other nodes by following the same steps. The first cluster added to the node has a Role of **OLDEST**. Clusters added after that will show a Role of **NONE** or **null**.

To configure load balancing for the XenMobile cluster in NetScaler

After you add the required nodes as members of the XenMobile cluster, you need to load balance the nodes to be able to access the clusters. Load balancing is done by running XenMobile Wizard available in NetScaler 10.5.x. You can following the steps in this procedure to load balance XenMobile by running the wizard.

1. Log on to NetScaler.



2. On the Configuration tab, click XenMobile and then click Get Started.

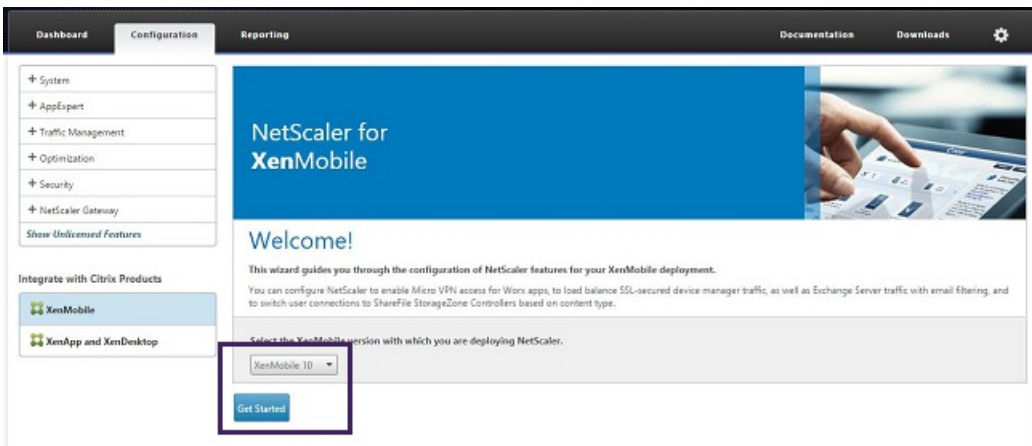

3. Select the Access through NetScaler Gateway check box and the Load Balance XenMobile Servers check box and then click Continue.

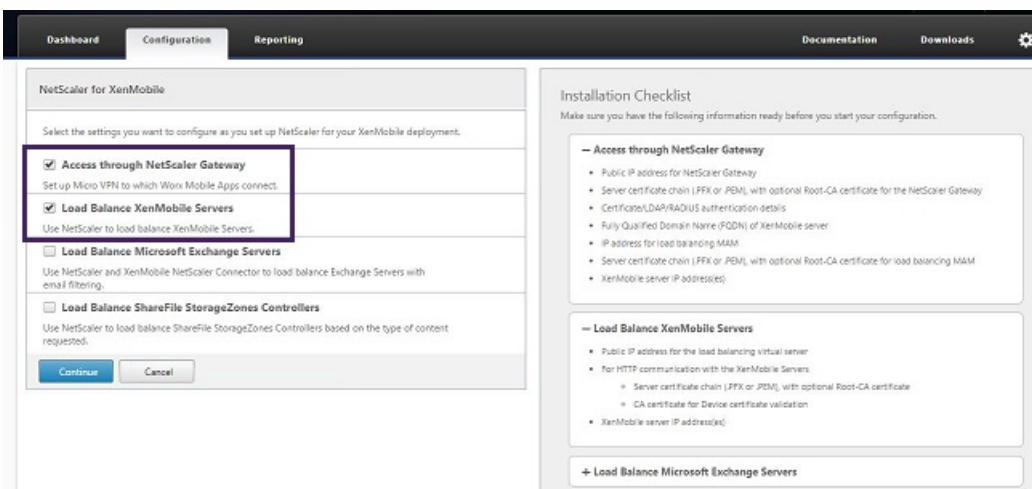

4. Enter the IP address for NetScaler Gateway and then click Continue.

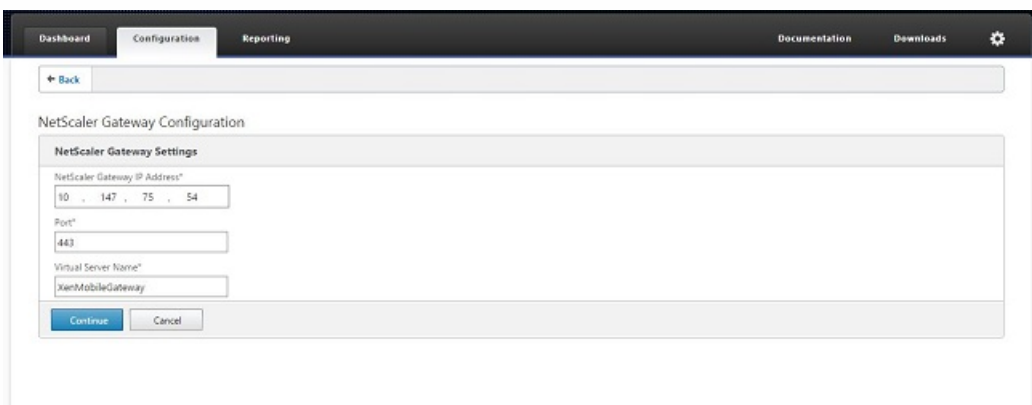

5. Bind the server certificate to the NetScaler Gateway virtual IP address by doing one of the following and then click Continue.
 - In Use existing certificate, choose the server certificate from the list.
 - Click the Install Certificate tab to upload a new server certificate.

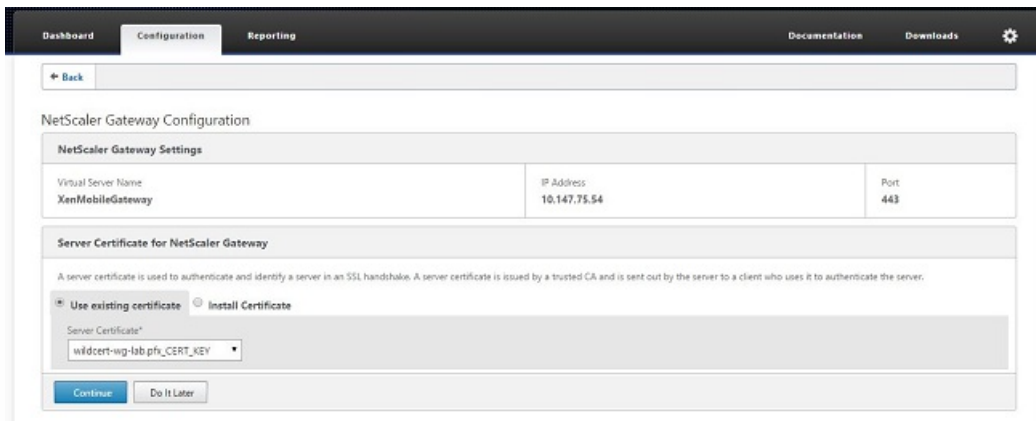

6. Enter the Authentication server details and then click Continue.

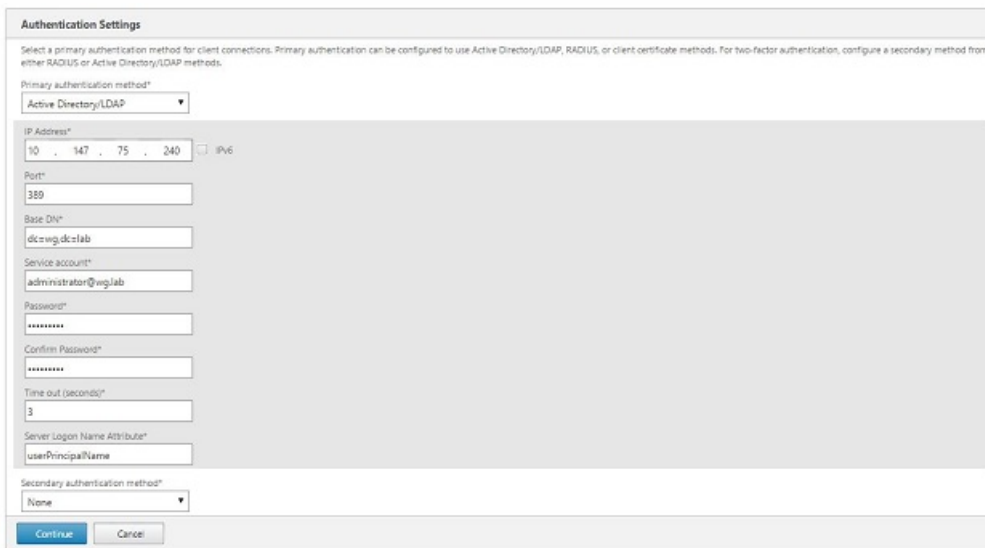

Note: Make sure the Server Logon Name Attribute is same as you provided in the XenMobile LDAP configuration.

7. Under XenMobile settings, enter the Load Balancing FQDN for MAM and then click Continue.



Note: Make sure the FQDN of the MAM load balancing virtual IP address and the FQDN of XenMobile are the same.

8. If you want to use SSL Bridge mode (HTTPS), select HTTPS communication to XenMobile Server. However, if you want to use SSL offload, select HTTP communication to XenMobile Server, as shown in the preceding figure. For the purposes of this article, the choice is SSL Bridge mode (HTTPS).

9. Bind the server certificate for the MAM load balancing virtual IP address and then click Continue.

XenMobile Settings

Load Balancing FQDN for MAM	xms51.wg.lab	SSL Traffic Configuration	HTTPS communication to XMS Server
Load Balancing IP address for MAM	10.147.75.55	Split Tunnel	OFF
Port	8443	Split DNS	BOTH

Server Certificate for MAM Load Balancing

A server certificate is used to authenticate and identify a server in an SSL handshake. A server certificate is issued by a trusted CA and is sent out by the server to a client who uses it to authenticate the server.

Use existing certificate
 Install Certificate

Server Certificate*

wildcert-wg-lab.pfx_CERT_KEY

10. Under XenMobile Servers, click Add Server to add the XenMobile nodes.

Server Certificate for MAM Load Balancing

wildcert-wg-lab.pfx_CERT_KEY_1
 wildcert-wg-lab.pfx_CERT_KEY

XenMobile Servers

IP Address	Port
XenMobile Server IP Address is not configured. Please click on Add Server to configure.	

11. Enter the IP address of the XenMobile node and then click Add.

XenMobile Server IP Addresses

Enter the IP address(es) of the XenMobile server(s) that you want to load balance.

XenMobile Server IP Address*

10 . 147 . 75 . 51

12. Repeat steps 10 and 11 to add additional XenMobile nodes that are part of the XenMobile cluster. You will see all the XenMobile nodes that you have added. Click Continue.

Server Certificate for MAM Load Balancing

wildcert-wg-lab.pfx_CERT_KEY_1
 wildcert-wg-lab.pfx_CERT_KEY

XenMobile Servers

IP Address	Port
10.147.75.51	8443
10.147.75.59	8443

13. Click Load Balance Device Manager Servers to continue with the MDM load balancing configuration.

XenMobile Servers	
IP Address	Port
10.147.75.51	8443
10.147.75.59	8443

14. Enter the IP address to be used for MDM load balancing IP address and then click Continue.

15. Once you see the XenMobile nodes in the list, click Continue and then click Done to finish the process.

You will see the virtual IP address status on the XenMobile page.

16. To confirm if the virtual IP addresses are up and running, click the Configuration tab and then navigate to Traffic Management > Load Balancing > Virtual Servers.

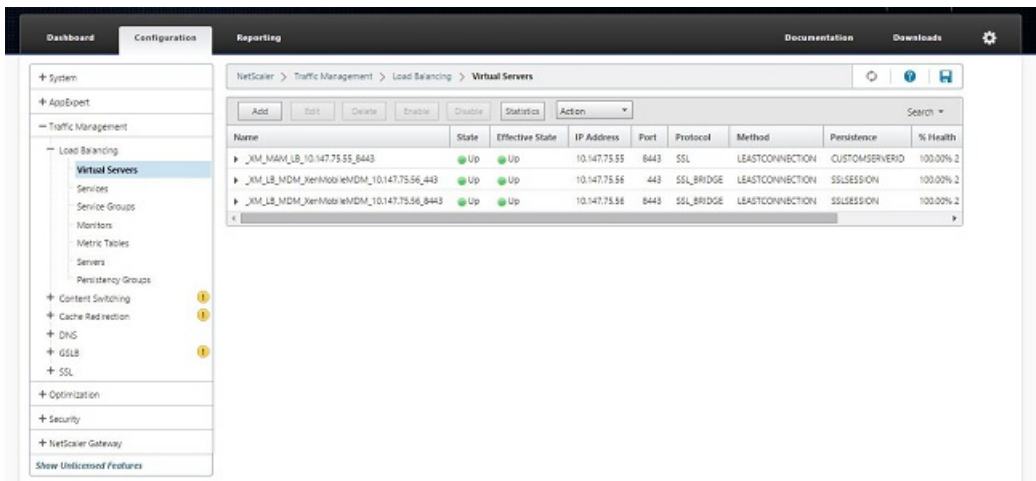

You will also see that the DNS entry in NetScaler points to the MAM load balancing virtual IP address.

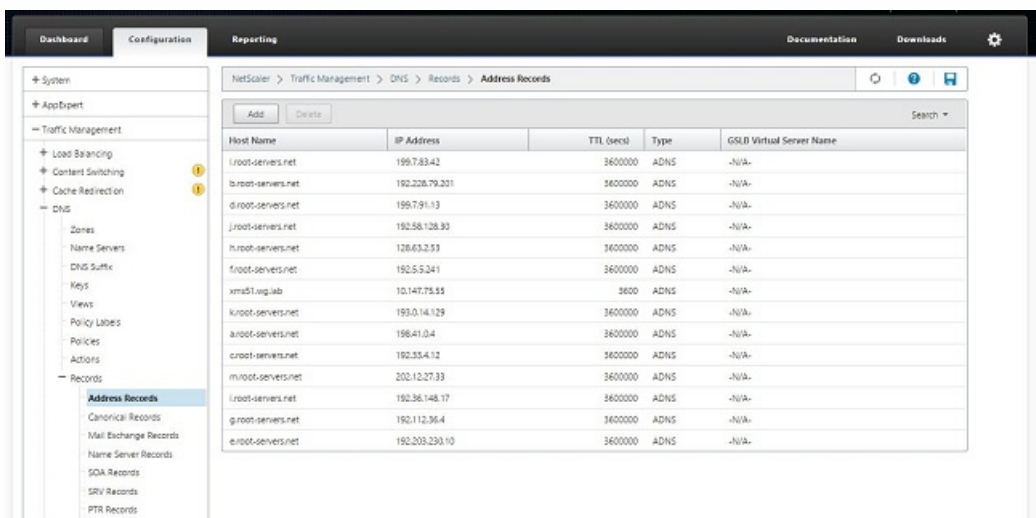

Disaster recovery guide

Jun 19, 2017

You can architect and configure XenMobile deployments that include multiple sites for disaster recovery using an active-passive failover strategy. For details, see the XenMobile Deployment Handbook [Disaster Recovery](#) article.

Enable proxy servers

Jun 19, 2017

When you want to control outbound internet traffic, you can set up a proxy server in XenMobile to carry that traffic. To do this, you need to set up the proxy server through the command-line interface (CLI). Note that setting up the proxy server requires restarting your system.

1. In the XenMobile CLI main menu, type **2** to select the System Menu.

2. In the System Menu, type **6** to select the Proxy Server Menu.

```
[2] System
[3] Troubleshooting
[4] Help
[5] Log Out
-----
Choice: [0 - 5] 2
-----
System Menu
-----
[0] Back to Main Menu
[1] Display System Date
[2] Set Time Zone
[3] Display System Disk Usage
[4] Update Hosts File
[5] Display Device Management Instance Name
[6] Proxy Server
[7] Admin (CLI) Password
[8] Restart Server
[9] Shutdown Server
[10] Advanced Settings
-----
```

3. In the Proxy Configuration Menu, type **1** to select SOCKS, **2** to select HTTPS, or **3** to select HTTP.

```
Choice: [0 - 10] 6
-----
Proxy Configuration Menu
-----
[0] Back to System Menu
[1] SOCKS
[2] HTTPS
[3] HTTP
[4] Exclusion List
[5] Display Configuration
[6] Delete Proxy Configuration
-----
```

4. Type your proxy server IP address, port number, and target. See the following table for supported target types for each proxy server type.

Proxy type	Supported targets
SOCKS	APNS

HTTP	APNS, Web, PKI
HTTPS	Web, PKI
HTTP with authentication	Web, PKI
HTTPS with authentication	Web, PKI

```

-----
Proxy Configuration Menu
-----
[0] Back to System Menu
[1] SOCKS
[2] HTTPS
[3] HTTP
[4] Exclusion List
[5] Display Configuration
[6] Delete Proxy Configuration
-----
Choice: [0 - 6] 1
Enter socks proxy information
Address [1]: 203.0.113.23
Port[]: 1080
Target - APNS
Proxy configuration updated successfully.
Please restart all nodes in the cluster for the changes to take effect
Are you sure to restart the system? [y/n]: █

```

5. If you choose to configure a user name and password for authentication on your HTTP or HTTPS proxy server, type **y**, and then type the user name and password.

```

[0] Back to System Menu
[1] SOCKS
[2] HTTPS
[3] HTTP
[4] Exclusion List
[5] Display Configuration
[6] Delete Proxy Configuration
-----
Choice: [0 - 6] 2
Enter https proxy information
Address [1]: 203.0.113.23
Port[]: 4443
Configure username & password [y/n]: y
Username: Justaname
Password:
Target - WEB
WEB proxy configured. Override proxy settings?[y/n]: █

```

6. Type **y** to finish setting up your proxy server.

Server properties

Jul 14, 2017

XenMobile has many properties that apply to server-wide operations. This article describes many of the server properties and details how to add, edit, or delete server properties.

Some properties are Custom Keys. To add a custom key, click **Add** and then, from **Key**, choose **Custom Key**.

For information about the properties typically configured, see [Server Properties](#) in the XenMobile virtual handbook.

Server Property Definitions

Add Device Always

If **true**, XenMobile adds a device to the XenMobile console, even if it fails enrollment, so you can see which devices attempted to enroll. Defaults to **false**.

AG Client Cert Issuing Throttling Interval

The grace period between generating certificates. This interval prevents XenMobile from generating multiple certificates for a device in a short time period. Citrix recommends that you not change this value. Defaults to **30** minutes.

Audit Log Cleanup Execution Time

The time to start the audit log cleanup, formatted as HH:MM AM/PM. Example: 04:00 AM. Defaults to **02:00 AM**.

Audit Log Cleanup Interval (in Days)

The number of days that XenMobile retains the audit log. Defaults to **1**.

Audit Logger

If **False**, does not log user interface (UI) events. Defaults to **False**.

Audit Log Retention (in Days)

The number of days that XenMobile retains the audit log. Defaults to **7**.

auth.ldap.connect.timeout

auth.ldap.read.timeout

To compensate for slow LDAP responses, Citrix recommends that you add server properties for the following Custom Keys.

Key: **Custom Key**

Key: **auth.ldap.connect.timeout**

Value: **60000**

Display name: **auth.ldap.connect.timeout=60000**

Description: LDAP connection timeout

Key: **Custom Key**

Key: **auth.ldap.read.timeout**

Value: **60000**

Display name: **auth.ldap.read.timeout=60000**

Description: LDAP read timeout

Certificate Renewal in Seconds

The number of seconds before a certificate expires that XenMobile starts to renew certificates. For example, if a certificate will expire December 30 and this property is set to 30 days: If the device connects between December 1 and December 30, XenMobile attempts to renew the certificate. Defaults to **2592000** seconds (30 days).

Connection Timeout

The session inactivity timeout, in minutes, after which XenMobile closes the TCP connection to a device. The session remains open. Applies to Android and Windows CE devices and Remote Support. Defaults to **5** minutes.

Connection Timeout to Microsoft Certification Server

The number of seconds that XenMobile waits for a response from the certificate server. If the certificate server is slow and has much traffic, increase this value to 60 seconds or more. A certificate server that doesn't respond after 120 seconds requires maintenance. Defaults to **15000** milliseconds (15 seconds).

Default deployment channel

Determines how XenMobile deploys a resource to a device: At the user-level (**DEFAULT_TO_USER**) or device-level. Defaults to **DEFAULT_TO_DEVICE**.

Deploy Log Cleanup (in Days)

The number of days that XenMobile retains the deployment log. Defaults to **7**.

Disable SSL Server Verification

If **True**, disables SSL server certificate validation when all the following conditions are met:

- You enabled certificate-based authentication on your XenMobile Server
- The Microsoft CA server is the certificate issuer
- An internal CA, whose root XenMobile Server doesn't trust, signed your certificate.

Defaults to **True**.

Enable Console

If **true**, enables user access to the Self Help Portal Console. Defaults to **true**.

Enable Crash Reporting

If **true**, Citrix collects crash reports and diagnostics to help troubleshoot issues with Secure Hub for iOS and Android.

If **false**, no data is collected. Default value is **true**.

Enable/Disable Hibernate statistics logging for diagnostics

If **True**, enables Hibernate statistics logging to assist with troubleshooting application performance issues. Hibernate is a component used for XenMobile connections to Microsoft SQL Server. By default, the logging is disabled because it impacts application performance. Enable logging only for a short duration to avoid creating a huge log file. XenMobile writes the logs to `/opt/sas/logs/hibernate_stats.log`. Defaults to **False**.

Enable macOS OTAE

If **false**, prevents the use of an enrollment link for macOS devices, meaning macOS users can enroll only by using an enrollment invitation. Defaults to **true**.

Enable Notification Trigger

Enables or disables Secure Hub client notifications. The value **true** enables notifications. Defaults to **true**.

force.server.push.required.apps

Enables the forced deployment of required apps on Android and iOS devices in situations such as the following:

- You upload a new app and mark it as required.
- You mark an existing app as required.
- As user deletes a required app.
- A Secure Hub update is available.

Forced deployment of required apps is **false** by default. Create the custom key and set **Value** to **true** to enable forced deployment. During forced deployment, Enterprise apps upgrade immediately even if you set an App update grace period and the user taps to upgrade the app later.

Key: **Custom Key**

Key: **force.server.push.required.apps**

Value: **false**

Display name: **force.server.push.required.apps**

Description: Force required apps to deploy

Full Pull of ActiveSync Allowed and Denied Users

The number of seconds that XenMobile waits for a response from the domain when executing a PowerShell command to get a baseline of ActiveSync devices. Defaults to **28800** seconds.

hibernate.c3p0.max_size

This Custom Key determines the maximum number of connections that XenMobile can open to the SQL Server database. XenMobile uses the value you specify for this custom key as an upper limit. The connections open only if you need them. Base your settings on the capacity of your database server. For more information, see [Tuning XenMobile Operations](#). Configure the key as follows. Default is **1000**.

Key: **hibernate.c3p0.max_size**

Value: **500**

Display name: **hibernate.c3p0.max_size=nnn**

Description: DB connections to SQL

hibernate.c3p0.timeout

This CustomKey determines the idle time-out. Default is **300**.

Key: **Custom Key**

Key: **hibernate.c3p0.timeout**

Value: **30**

Display name: **hibernate.c3p0.timeout=30**

Description: Database idle timeout

Identifies if telemetry is enabled or not

Identifies if telemetry (Customer Experience Improvement Program, or CEIP) is enabled. You can opt in to CEIP when you install or upgrade XenMobile. If XenMobile has 15 consecutive failed uploads, it disables telemetry. Defaults to **false**.

Inactivity Timeout in Minutes

If the **WebServices timeout type** server property is **INACTIVITY_TIMEOUT**: This property defines the number of minutes after which XenMobile logs out an inactive administrator who did the following:

- Used the XenMobile Public API for REST Services to access the XenMobile console
- Used the XenMobile Public API for REST Services to access any third-party app. A timeout of **0** means that an inactive user remains logged in.

Defaults to **5**.

iOS Device Management Enrollment Auto-Install Enabled

If true, this property reduces the amount of user interaction required during device enrollment. Users must click **Root CA install** (if needed) and **MDM Profile install**.

iOS Device Management Enrollment First Step Delayed

After a user enters their credentials during device enrollment, this value specifies how long to wait before prompting for the root CA. Citrix recommends that you edit this property only for network latency or speed issues. In that case, don't set to the value to more than 5000 milliseconds (5 seconds). Defaults to **1000** milliseconds (1 second).

iOS Device Management Enrollment Last Step Delayed

During device enrollment, this property value specifies the amount of time to wait between installing the MDM profile and starting the Agent on the device. Citrix recommends that you edit this property only for network latency or speed issues. In that case, don't set to the value to more than 5000 milliseconds (5 seconds). Defaults to **1000** milliseconds (1 second).

iOS Device Management Identity Delivery Mode

Specifies whether XenMobile distributes the MDM certificate to devices using **SCEP** (recommended for security reasons) or **PKCS12**. In PKCS12 mode, the key pair is generated on the server and no negotiation is performed. Defaults to **SCEP**.

iOS Device Management Identity Key Size

Defines the size of private keys for MDM identities, iOS profile service, and XenMobile iOS agent identities. Defaults

to **1024**.

iOS Device Management Identity Renewal Days

Specifies the number of days before the certificate expiration that XenMobile starts renewing certificates. For example: If a certificate expires in 10 days and this property is **10** days, when a device connects 9 days before expiration, XenMobile issues a new certificate. Defaults to **30** days.

iOS MDM APNS Private Key Password

This property contains the APNs password, which is required for XenMobile to push notifications to Apple servers.

iOS MDM APNS Private Key Password

This property contains the APNs password, which is required for XenMobile to push notifications to Apple servers.

Length of Inactivity Before Device Is Disconnected

Specifies how long a device can remain inactive, including the last authentication, before XenMobile disconnects it. Defaults to **7** days.

MAM Only Device Max

This Custom Key limits the number of MAM-only devices that each user can enroll. Configure the key as follows. A **Value** of **0** allows unlimited device enrollments.

Key = **number.of.mam.devices.per.user**

Value = **5**

Display name = **MAM Only Device Max**

Description = Limits the number of MAM devices each user can enroll.

NetScaler Single Sign-On

If **False**, disables the XenMobile callback feature during single signon from NetScaler to XenMobile. If the NetScaler Gateway configuration includes a callback URL, XenMobile uses the callback feature to verify the NetScaler Gateway session ID. Defaults to **False**.

Number of consecutive failed uploads

Displays the number of consecutive failures during Customer Experience Improvement Program (CEIP) uploads. XenMobile increments the value when an upload fails. After 15 upload failures, XenMobile disables CEIP, also called telemetry. For more information, see the server property **Identifies if telemetry is enabled or not**. XenMobile resets the value to **0** when an upload succeeds.

Number of Users Per Device

The maximum number of users who can enroll the same device in MDM. The value **0** means that an unlimited number of users can enroll the same device. Defaults to **0**.

Pull of Incremental Change of Allowed and Denied Users

The number of seconds that XenMobile waits for a response from the domain when executing a PowerShell command to get a delta of ActiveSync devices. Defaults to **60** seconds.

Read Timeout to Microsoft Certification Server

The number of seconds that XenMobile waits for a response from the certificate server when performing a read. If the certificate server is slow and has much traffic, you can increase this value to 60 seconds or more. A certificate server that doesn't respond after 120 seconds requires maintenance. Defaults to **15000** milliseconds (15 seconds).

REST Web Services

Enables the REST Web Service. Defaults to **true**.

Retrieves devices information in chunks of specified size

This value is used internally for multithreading during device exports. If the value is higher, a single thread parses more devices. If the value is lower, more threads fetch the devices. Reducing the value might increase the performance of exports and device list fetches, yet might reduce available memory. Defaults to **1000**.

Session Log Cleanup (in Days)

The number of days that XenMobile retains the session log. Defaults to **7**.

Server Mode

Determines whether XenMobile runs in MAM, MDM, or ENT (enterprise) mode, corresponding to app management, device management, or app and device management. Set the Server Mode property according to how you want devices to register, as noted in the table below. Server Mode defaults to **ENT**, regardless of license type.

If you have a XenMobile MDM Edition license, the effective server mode is always MDM regardless of how you set the server mode in Server Properties. If you have an MDM Edition license, you cannot enable app management by setting the server mode to either MAM or ENT.

Your licenses are this Edition	You want devices to register in this mode	Set Server Mode property to
Enterprise / Advanced	MDM mode	MDM
Enterprise / Advanced	MDM+MAM mode	ENT
MDM	MDM mode	MDM

The effective server mode is a combination of the license type and server mode. For an MDM license, the effective server mode is always MDM, regardless of the server mode setting. For Enterprise and Advanced licenses, the effective server mode matches the server mode, if the server mode is **ENT** or **MDM**. If the server mode is **MAM**, the effective server mode is ENT.

XenMobile adds the server mode to the server log for each of these activities: A license is activated, a license is deleted, and you change the server mode in Server Properties. For information about creating and viewing log files, see [Logs](#) and [View and analyze log files in XenMobile](#).

ShareFile configuration type

Specifies the ShareFile storage type. **ENTERPRISE** enables ShareFile Enterprise mode. **CONNECTORS** provides access only to StorageZone Connectors that you create through the XenMobile console. Defaults to **NONE**, which shows the initial view of the **Configure > ShareFile** screen where you choose between ShareFile Enterprise and Connectors. Defaults to **NONE**.

Static Timeout in Minutes

If the **WebServices timeout type** server property is **STATIC_TIMEOUT**: This property defines the number of minutes after which XenMobile logs out an administrator after using the following:

- The XenMobile Public API for REST Services to access the XenMobile console.
- The XenMobile Public API for REST Services to access any third-party app.

Defaults to **60**.

Trigger Agent Message Suppression

Enables or disables Secure Hub client messaging. The value **false** enables messaging. Defaults to **true**.

Trigger Agent Sound Suppression

Enables or disables Secure Hub client sounds. The value **false** enables sounds. Defaults to **true**.

Unauthenticated App Download for Android Devices

If **True**, you can download self-hosted apps to Android devices running Android for Work. XenMobile needs this property if the Android for Work option to provide a download URL in the Google Play Store statically is enabled. In that case, download URLs can't include a one-time ticket (defined by the **XAM One-Time Ticket server** property) which has the authentication token. Defaults to **False**.

Unauthenticated App Download for Windows Devices

Used only for older Secure Hub versions which don't validate one-time tickets. If **False**, you can download unauthenticated apps from XenMobile to Windows devices. Defaults to **False**.

Use ActiveSync ID to Conduct an ActiveSync Wipe Device

If **true**, XenMobile Mail Manager uses the ActiveSync identifier as an argument for the `asWipeDevice` method. Defaults to **false**.

User-Defined Device Properties N

Used for Windows CE devices only. This custom key enables you to obtain properties that you create in the registry of Windows CE devices. After those properties are in the XenMobile database, you can create deployment rules based on the value of the properties.

Key: **Custom Key**

Key: **device.properties.userDefinedN**

Value: <administrator-defined>

Display name: <administrator-defined>

Description: <administrator-defined>

Users only from Exchange

If **true**, disables user authentication for ActiveSync Exchange users. Defaults to **false**.

VPP baseline interval

The minimum interval that XenMobile reimports VPP licenses from Apple. Refreshing license information ensures that XenMobile reflects all changes, such as when you manually delete an imported app from VPP. By default, XenMobile refreshes the VPP license baseline a minimum of every **720** minutes.

If you have many VPP licenses installed (for example, more than 50,000): Citrix recommends that you increase the baseline interval to reduce the frequency and overhead of importing licenses. If you expect frequent VPP license changes from Apple: Citrix recommends that you lower the value to keep XenMobile updated with the changes. The minimum interval between two baselines is 60 minutes. In addition, XenMobile performs a delta import every 60 minutes, to capture the changes since the last import. Therefore, if the VPP baseline interval is 60 minutes, the interval between baselines could be delayed up to 119 minutes.

WebServices Timeout Type

Specifies how to expire an authentication token retrieved from the public API. If **STATIC_TIMEOUT**, XenMobile considers an authentication token as expired after the value specified in the server property **Static Timeout in Minutes**.

If **INACTIVITY_TIMEOUT**, XenMobile considers an authentication token as expired after the token is inactive for the value specified in the server property **Inactivity Timeout in Minutes**. Defaults to **STATIC_TIMEOUT**.

Windows Phone MDM Certificate Extended Validity (5y)

The validity period of the device certificate issued by MDM for Windows Phone and Tablet. Devices use a device certificate to authenticate to the MDM server during device management. If **true**, the validity period is five years. If **false**, the validity period is two years. Defaults to **true**.

Windows WNS Channel - Number of Days Before Renewal

The renewal frequency for the ChannelURI. Defaults to **10** days.

Windows WNS Heartbeat Interval

How long XenMobile waits before connecting to a device after connecting to it every three minutes five times. Defaults to **6** hours.

XAM One-Time Ticket

The number of milliseconds that a one-time authentication token (OTT) is valid for downloading an app. This property works with the properties **Unauthenticated App download for Android** and **Unauthenticated App download for Windows**. Those properties specify whether to allow unauthenticated app downloads. Defaults to **3600000**.

XenMobile MDM Self Help Portal console max inactive interval (minutes)

The number of minutes after which XenMobile logs out an inactive user from the XenMobile Self Help Portal. A timeout of **0** means that an inactive user remains logged in. Defaults to **30**.

Adding, Editing, or Deleting Server Properties

In XenMobile, you can apply properties to the server. After making changes, ensure that you restart XenMobile on all nodes to commit and activate changes.

Note

To restart XenMobile, use the command prompt through your hypervisor.

1. In the XenMobile console, click the gear icon in the upper-right corner. The **Settings** page appears.
2. Under **Server**, click **Server Properties**. The **Server Properties** page appears. You can add, edit, or delete server properties from this page.

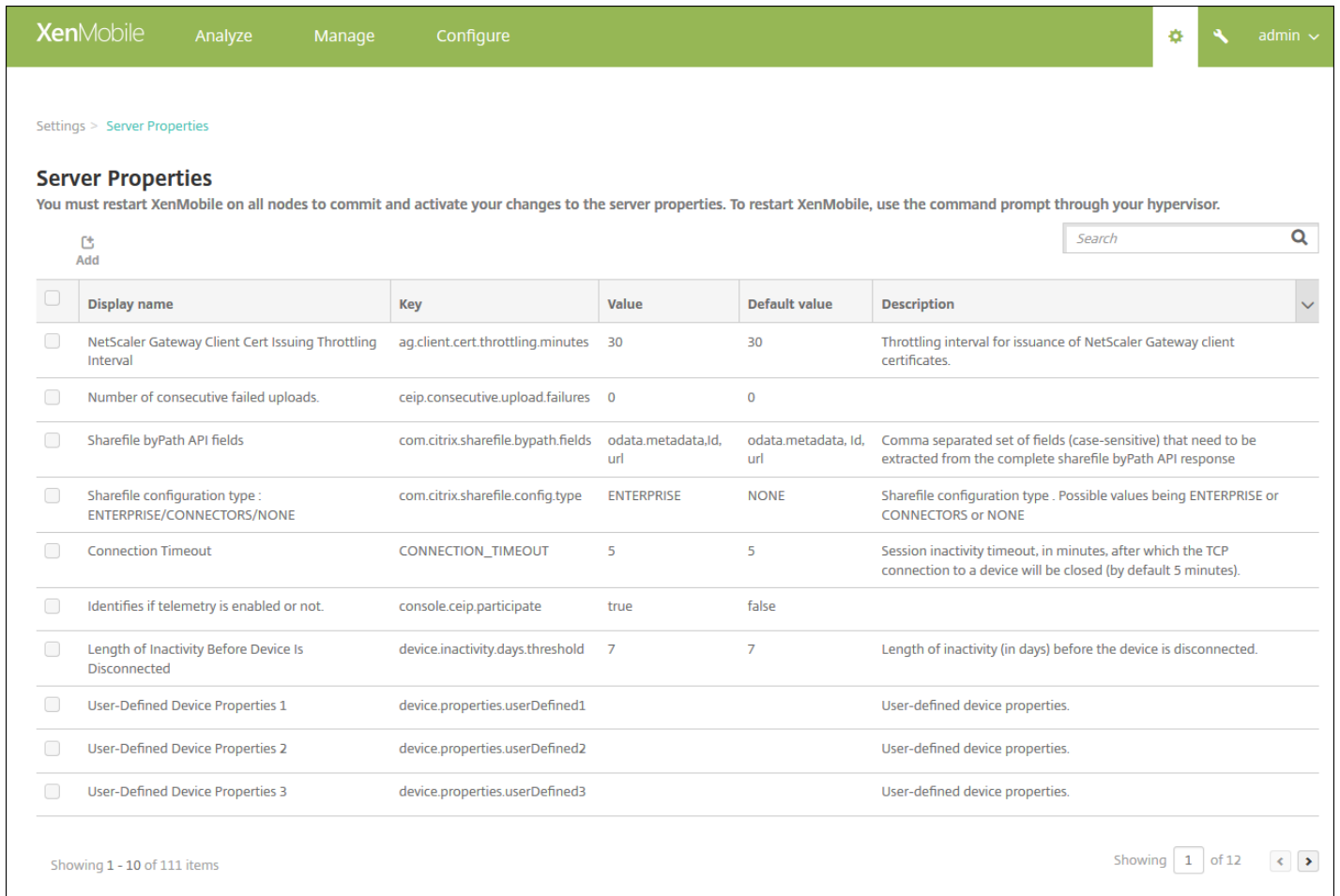

The screenshot shows the XenMobile console interface. The top navigation bar includes 'XenMobile', 'Analyze', 'Manage', and 'Configure'. The user is logged in as 'admin'. The current page is 'Settings > Server Properties'. A warning message states: 'You must restart XenMobile on all nodes to commit and activate your changes to the server properties. To restart XenMobile, use the command prompt through your hypervisor.' Below this is a search bar and an 'Add' button. The main content is a table of server properties:

<input type="checkbox"/>	Display name	Key	Value	Default value	Description
<input type="checkbox"/>	NetScaler Gateway Client Cert Issuing Throttling Interval	ag.client.cert.throttling.minutes	30	30	Throttling interval for issuance of NetScaler Gateway client certificates.
<input type="checkbox"/>	Number of consecutive failed uploads.	ceip.consecutive.upload.failures	0	0	
<input type="checkbox"/>	Sharefile byPath API fields	com.citrix.sharefile.bypath.fields	odata.metadata.id, url	odata.metadata, id, url	Comma separated set of fields (case-sensitive) that need to be extracted from the complete sharefile byPath API response
<input type="checkbox"/>	Sharefile configuration type : ENTERPRISE/CONNECTORS/NONE	com.citrix.sharefile.config.type	ENTERPRISE	NONE	Sharefile configuration type . Possible values being ENTERPRISE or CONNECTORS or NONE
<input type="checkbox"/>	Connection Timeout	CONNECTION_TIMEOUT	5	5	Session inactivity timeout, in minutes, after which the TCP connection to a device will be closed (by default 5 minutes).
<input type="checkbox"/>	Identifies if telemetry is enabled or not.	console.ceip.participate	true	false	
<input type="checkbox"/>	Length of Inactivity Before Device Is Disconnected	device.inactivity.days.threshold	7	7	Length of inactivity (in days) before the device is disconnected.
<input type="checkbox"/>	User-Defined Device Properties 1	device.properties.userDefined1			User-defined device properties.
<input type="checkbox"/>	User-Defined Device Properties 2	device.properties.userDefined2			User-defined device properties.
<input type="checkbox"/>	User-Defined Device Properties 3	device.properties.userDefined3			User-defined device properties.

Showing 1 - 10 of 111 items

Showing 1 of 12

To add a server property

1. Click **Add**. The **Add New Server Property** page appears.

XenMobile Analyze Manage Configure

Settings > Server Properties > Add New Server Property

Add New Server Property

Key ?

Value*

Display name*

Description

Cancel Save

2. Configure these settings:

- **Key:** In the list, select the appropriate key. Keys are case-sensitive. Contact Citrix Support before you edit property values or to request a special key.
- **Value:** Enter a value depending on the key you selected.
- **Display name:** Enter a name for the new property value that appears in the **Server Properties** table.
- **Description:** Optionally, type a description for the new server property.

3. Click **Save**.

To edit a server property

1. In the **Server Properties** table, select the server property you want to edit.

Note: When you select the check box next to a server property, the options menu appears above the server property list. When you click anywhere else in the list, the options menu appears on the right side of the listing.

2. Click **Edit**. The **Edit New Server Property** page appears.

Settings > Server Properties > Edit New Server Property

Edit New Server Property

Key

Value*

Display name*

Description

3. Change the following information as appropriate:

- **Key:** You cannot change this field.
- **Value:** The property value.
- **Display Name:** The property name.
- **Description:** The property description.

4. Click **Save** to save your changes or **Cancel** to leave the property unchanged.

To delete a server property

1. In the **Server Properties** table, select the server property you want to delete.

Note: You can select more than one property to delete by selecting the check box next to each property.

2. Click **Delete**. A confirmation dialog box appears. Click **Delete** again.

Command-line interface options

Jun 19, 2017

For an on-premises installation of XenMobile Server, you can access the CLI options at any time as follows:

- **From the hypervisor on which you installed XenMobile:** In your hypervisor, select the imported XenMobile virtual machine, start the command prompt view, and log on to your administrator account for XenMobile. For details, see the documentation for your hypervisor.
- **If SSH is enabled in your firewall, by using SSH.** Log on to your administrator account for XenMobile.

You can perform various configuration and troubleshooting tasks using the CLI. Following is the top-level menu for the CLI.

```
-----
Main Menu
-----
[0] Configuration
[1] Clustering
[2] System
[3] Troubleshooting
[4] Help
[5] Log Out
-----
```

Configuration options

Following are samples of the **Configuration Menu** and the settings displayed for each option.

```
-----
Configuration Menu
-----
[0] Back to Main Menu
[1] Network
[2] Firewall
[3] Database
[4] Listener Ports
-----
```

[1] Network

```
Reboot is required to save the changes.
Do you want to proceed? (y/n) [y]: y
IP address [10.207.87.75]: 10.200.87.75
Netmask [255.255.254.0]: 255.255.254.0
Default gateway [10.207.86.1]: 10.200.86.1
Primary DNS server [10.207.86.50]: 10.200.86.50
Secondary DNS server (optional) []:

Applying network settings...

Are you sure to restart the system? [y/n]: █
```

[2] Firewall

```

Configure which services are enabled through the firewall.

Can optionally configure allow access white lists:
- comma separated list of hosts or networks
- e.g. 10.20.5.3, 10.20.6.0/24
- an empty value means no access restriction
- enter c as value to clear list

HTTP service
  Port: 80
  Enable access (y/n) [y]: y
  Access white list []:

Management HTTPS service
  Port: 4443
  Enable access (y/n) [y]:
  Access white list []:

SSH service
  Port [22]:
  Enable access (y/n) [y]:
  Access white list []:

Management API (for initial staging) HTTPS service
  Port [30001]:
  Enable access (y/n) [n]:

Remote support tunnel
  Port [8081]:
  Enable access (y/n) [n]:

Applying firewall settings ...
Writing iptables configuration...
Restarting iptables...

```

[3] Database

```

Type: [mi]
Use SSL (y/n) [n]:
Server [10.207.86.64]:
Port [1433]:
Username [sa]:
Password:
Database name [RC]:

Reboot is required to save the changes.
Do you want to proceed? (y/n) [y]: █

```

[4] Listener Ports

```

Reboot is required to save the changes.
Do you want to proceed? (y/n) [y]: y
HTTP [80]:
HTTPS with certificate authentication [443]:
HTTPS with no certificate authentication [8443]:
HTTPS for management [4443]:
Applying port listener configuration...
Applying firewall settings ...
Writing iptables configuration...
Restarting iptables...
Are you sure to restart the system? [y/n]: █

```

Clustering options

Following are samples of the **Clustering Menu** and the settings displayed for each option.

```
-----
Clustering Menu
-----
[0] Back to Main Menu
[1] Show Cluster Status
[2] Enable/Disable cluster
[3] Cluster member white list
[4] Enable or Disable SSL offload
[5] Display Hazelcast Cluster
-----
```

[1] Show Cluster Status

```
Current Node ID: 181360459

Cluster Members:
node: 10.207.87.75  status: ACTIVE  role: OLDEST
node: 10.207.87.77  status: ACTIVE  role: NONE
node: 10.207.87.88  status: ACTIVE  role: NONE
```

[2] Enable/Disable cluster

When you choose to enable clustering, the following message appears:

To enable realtime communication between cluster members, please open port 80 using the Firewall menu option in CLI menu. Also configure Access white list under Firewall settings for restricted access.

When you choose to disable clustering, the following message appears:

You have chosen to disable clustering. Access to port 80 is not needed. Please disable it.

[3] Cluster member white list

```
Current White List:
- comma separated list of hosts or networks
- e.g. 10.20.5.3, 10.20.6.0/24
- an empty value means no access restriction

Please enter hosts or networks to be white listed:
```

[4] Enable or disable SSL offload

When you select to enable or disable SSL offloading, the following message appears:

Enabling SSL offload will open port 80 for everyone. Please configure Access white list under Firewall settings for restricted access.

[5] Display Hazelcast Cluster

When you select to display the Hazelcast Cluster, the following options appear:

Hazelcast Cluster Members:

[IP addresses listed]

NOTE: If a configured node is not part of the cluster, please reboot that node.

System options

From the **System Menu**, you can display or set system-level information, restart or shut down the server, or access **Advanced Settings**.

```
-----
System Menu
-----
[0] Back to Main Menu
[1] Display System Date
[2] Set Time Zone
[3] Set NTP Server
[4] Display NTP Status
[5] Display System Disk Usage
[6] Update Hosts File
[7] Display Device Management Instance Name
[8] Proxy Server
[9] Admin (CLI) Password
[10] Restart Server
[11] Shutdown Server
[12] Advanced Settings
-----
```

[12] Advanced Settings

```
***** WARNING *****
Please only modify these options if you are
in contact with Citrix Support
*****

-----
Advanced Settings
-----
[0] Back to System Menu
[1] Toggle FIPS mode
[2] Custom Ciphers
[3] SSL protocols
[4] Reset SSL Certificate
[5] Reset pki.xml
[6] Server Tuning
-----
```

SSL protocols options default to all allowed protocols. After the prompt **New SSL protocols to enable**, type the protocols you want to enable. XenMobile disables any protocols that you don't include in your response. For example: To disable TLSv1, type **TLSv1.2,TLSv1.1** and then type **y** to restart XenMobile Server.

Server Tuning options include the server connection timeout, maximum connections (by port), and maximum threads (by port).

Troubleshooting options

Following are samples of the **Troubleshooting Menu** and the settings displayed for each option.

Troubleshooting Menu

```
-----  
[0] Back to Main Menu  
[1] Network Utilities  
[2] Logs  
[3] Support Bundle  
-----
```

[1] Network Utilities

Network Menu

```
-----  
[0] Back to Troubleshooting Menu  
[1] Network Information  
[2] Show Routing Table  
[3] Show Address Resolution Protocol (ARP) Table  
[4] PING  
[5] Traceroute  
[6] DNS Lookup  
[7] Network Trace  
-----
```

[2] Logs

Logs Menu

```
-----  
[0] Back to Troubleshooting Menu  
[1] Display Log File  
-----
```

[3] Support Bundle

Support Bundle Menu

```
-----  
[0] Back to Troubleshooting Menu  
[1] Generate Support Bundle  
[2] Upload Support Bundle by Using SCP  
[3] Upload Support Bundle by Using FTP  
-----
```

Getting started workflows for XenMobile console

Jun 19, 2017

The XenMobile console is the unified management tool in XenMobile. This article assumes you've installed XenMobile and are ready to work in the console. If you have yet to install XenMobile, see [Installing XenMobile](#). For details on browser support for the XenMobile console, see [XenMobile compatibility](#).

Initial settings workflow

After you finish configuring XenMobile first in the command-line console and next in the XenMobile console, the dashboard opens. You cannot return to the initial configuration screens. If you skipped some install configurations, you can configure the following settings in the console. Before you start adding users, apps, and devices, you consider completing these install settings. To start, click the gear icon in the upper-right corner of the console.

Note: The items with an asterisk are optional.

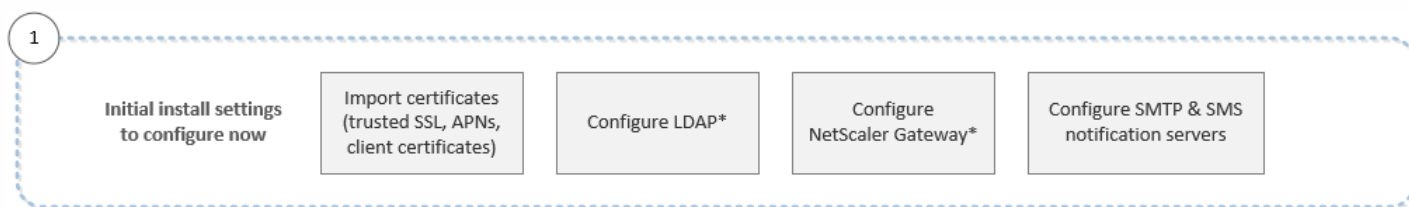

For more information about each setting, along with step-by-step procedures, see the following Citrix Product Documentation articles and sections:

- [Authentication](#)
- [NetScaler Gateway and XenMobile](#)
- [Notifications](#)

To support Android, iOS, and Windows platforms, you must have the following account-related setup.

Android

- Create Google Play credentials. For details, see Google Play [Launch](#).
- Create an Android for Work administrator account. For details, see [Android at Work](#).
- Verify your domain name with Google. For details, see [Verify your domain for G Suite](#).
- Enable APIs and create a service account for Android for Work. For details, see [Android enterprise Help](#).

iOS

- Create an Apple ID and developer account. For details, see the [Apple Developer Program](#) website.
- Create an Apple Push Notification Service (APNs) certificate. If you plan to manage iOS devices with your XenMobile Service (cloud) deployment, you need an Apple APNs certificate. If you use push notification for your WorxMail deployment, you also need an Apple APNs certificate. For details about obtaining Apple APNs certificates, see the [Apple Push Certificates Portal](#). For more information about XenMobile and APNs, see [APNs certificates](#) and [Push Notifications for WorxMail for iOS](#).
- Create a Volume Purchase Program (VPP) company token. For details, see [Apple Volume Purchasing Program](#).

Windows

- Create a Microsoft Windows Store developer account. For details, see the [Microsoft Windows Dev Center](#).
- Obtain a Microsoft Windows Store Publisher ID. For details, see the [Microsoft Windows Dev Center](#).
- Acquire an enterprise certificate from Symantec. For details, see the [Microsoft Windows Dev Center](#).
- Ensure that you have a public SSL certificate available if you plan to use XenMobile autodiscovery for your Windows Phone enrollment. For details, see [XenMobile Autodiscovery Service](#).
- Create an Application Enrollment Token (AET). For details, see the [Microsoft Windows Dev Center](#).

Console prerequisites workflow

This workflow shows prerequisites for you to configure before you add apps and devices.

Note: The items with an asterisk are optional.

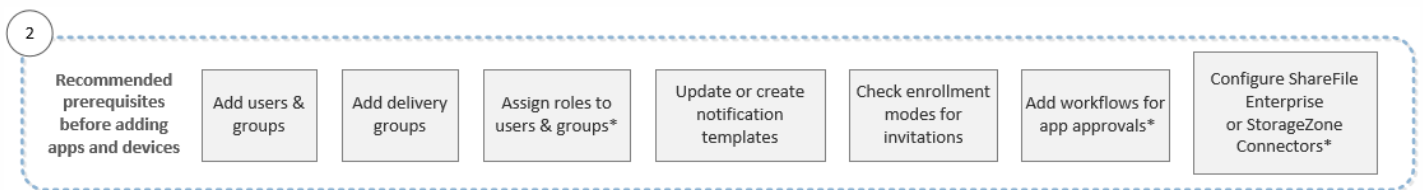

For more information about each setting, along with step-by-step procedures, see the following Citrix Product Documentation articles and sections:

- [User accounts, roles, and enrollment](#)
- [Deploy resources](#)
- [Configure roles with RBAC](#)
- [Notifications](#)
- [Create and manage workflows](#)
- [ShareFile use with XenMobile](#)

Add apps workflow

This workflow shows a recommended order to follow when adding apps to XenMobile.

Note: The items with an asterisk are optional.

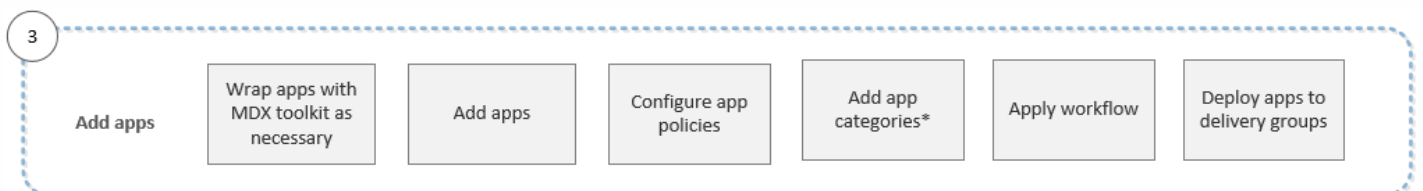

For more information about each setting, along with step-by-step procedures, see the following Citrix Product Documentation articles and sections:

- [About the MDX Toolkit](#)
- [Add apps](#)
- [MDX Policies at a Glance](#)

- [Create and manage workflows](#)
- [Deploy resources](#)

Add devices workflow

This workflow shows a recommended order to follow when adding and registering devices in XenMobile.

Note: The items with an asterisk are optional.



For more information about each setting, along with step-by-step procedures, see the following Citrix Product Documentation articles and sections:

- [Devices](#)
- [Supported device operating systems](#)
- [Deploy resources](#)
- [Monitor and support](#)
- [Automated actions](#)

Enroll user devices workflow

This workflow shows a recommended order to follow when enrolling user devices in XenMobile.



For more information about each setting, along with step-by-step procedures, see the following Citrix Product Documentation articles:

- [User accounts, roles, and enrollment](#)
- [Notifications](#)

Ongoing app and device management workflow

This workflow shows app and device management activities that you can do in the console.

Note: The items with an asterisk are optional.

6

Ongoing app and device management

View notifications and monitor devices and apps on the dashboard

Issue security actions on devices as necessary

Do connectivity checks, create support bundles and view logs*

For more information about the support options found from clicking the wrench icon in the upper-right corner of the console, see [Monitor and support](#).

Certificates and authentication

Jun 19, 2017

Several components play a role in authentication during XenMobile operations:

- **XenMobile Server:** The XenMobile Server is where you define enrollment security and the enrollment experience. Options for onboarding users include whether to make the enrollment open for all or by invitation only and whether to require two-factor authentication or three-factor authentication. Through client properties in XenMobile, you can enable Citrix PIN authentication and configure the complexity and expiration time of the PIN.
- **NetScaler:** NetScaler provides termination for micro VPN SSL sessions. NetScaler also provides network in-transit security, and lets you define the authentication experience used each time a user accesses an app.
- **Secure Hub:** Secure Hub works with XenMobile Server in enrollment operations. Secure Hub is the entity on a device that talks to NetScaler. When a session expires, Secure Hub gets an authentication ticket from NetScaler and passes the ticket to the MDX apps. Citrix recommends use of certificate pinning, which prevents man-in-the-middle attacks. For more information, see the section on certificate pinning in the [Secure Hub](#) article.

Secure Hub also facilitates the MDX security container: Secure Hub pushes policies, creates a session with NetScaler when an app times out, and defines the MDX timeout and authentication experience. Secure Hub is also responsible for jailbreak detection, geolocation checks, and any policies you apply.

- **MDX policies:** MDX policies create the data vault on the device. MDX policies direct micro VPN connections back to NetScaler, enforce offline mode restrictions, and enforce client policies, such as time-outs.

For more information about the considerations on how to configure authentication, including an overview of single-factor, and two-factor authentication methods, see the Deployment Handbook [Authentication](#) article.

You use certificates in XenMobile to create secure connections and authenticate users. The remainder of this article discusses certificates. For other configuration details, see the following articles:

- [Domain or domain plus security token authentication](#)
- [Client certificate or certificate plus domain authentication](#)
- [PKI entities](#)
- [Credential providers](#)
- [APNs certificates](#)
- [SAML for single sign-on with ShareFile](#)
- [Microsoft Azure Active Directory server settings](#)

Certificates

By default, XenMobile comes with a self-signed Secure Sockets Layer (SSL) certificate that is generated during installation to secure the communication flows to the server. Citrix recommends that you replace the SSL certificate with a trusted SSL certificate from a well-known certificate authority (CA).

Note

iOS 10.3 devices don't support self-signed certificates. If XenMobile uses self-signed certificates, users can't enroll iOS 10.3 devices

into XenMobile. To enroll devices running iOS 10.3 or later into XenMobile, you must use trusted SSL certificates in XenMobile.

XenMobile also uses its own Public Key Infrastructure (PKI) service or obtains certificates from the CA for client certificates. All Citrix products support wildcard and Subject Alternative Name (SAN) certificates. For most deployments, you only need two wildcard or SAN certificates.

Client certificate authentication provides an extra layer of security for mobile apps and lets users seamlessly access HDX Apps. When client certificate authentication is configured, users type their Citrix PIN for single sign-on (SSO) access to XenMobile-enabled apps. Citrix PIN also simplifies the user authentication experience. Citrix PIN is used to secure a client certificate or save Active Directory credentials locally on the device.

To enroll and manage iOS devices with XenMobile, set up and create an Apple Push Notification Service (APNs) certificate from Apple. For steps, see [APNs certificates](#).

The following table shows the certificate format and type for each XenMobile component:

XenMobile component	Certificate format	Required certificate type
NetScaler Gateway	PEM (BASE64) PFX (PKCS#12)	SSL, Root NetScaler Gateway converts PFX to PEM automatically.
XenMobile Server	.p12 (.pfx on Windows-based computers)	SSL, SAML, APNs XenMobile also generates a full PKI during the installation process. Important: XenMobile Server doesn't support certificates with a .pem extension.
StoreFront	PFX (PKCS#12)	SSL, Root

XenMobile supports SSL listener certificates and client certificates with bit lengths of 4096, 2048, and 1024. Note that 1024-bit certificates are easily compromised.

For NetScaler Gateway and the XenMobile Server, Citrix recommends obtaining server certificates from a public CA, such as Verisign, DigiCert, or Thawte. You can create a Certificate Signing Request (CSR) from the NetScaler Gateway or the XenMobile configuration utility. After you create the CSR, you submit it to the CA for signing. When the CA returns the signed certificate, you can install the certificate on NetScaler Gateway or XenMobile.

Uploading certificates in XenMobile

Each certificate you upload has an entry in the Certificates table, summarizing its contents. When you configure PKI integration components that require a certificate, you choose a server certificate that satisfies the context-dependent criteria. For example, you might want to configure XenMobile to integrate with your Microsoft CA. The connection to the

Microsoft CA must be authenticated by using a client certificate.

This section provides general procedures for uploading certificates. For details about creating, uploading, and configuring client certificates, see [Client certificate or certificate plus domain authentication](#).

Private key requirements

XenMobile may or may not possess the private key for a given certificate. Likewise, XenMobile may or may not require a private key for certificates you upload.

Uploading certificates to the console

When uploading certificates to the console, you have two main options:

- You can click to import a keystore. Then, you identify the entry in the keystore repository you want to install, unless you are uploading a PKCS#12 format.
- You can click to import a certificate.



You can upload the CA certificate (without the private key) that the CA uses to sign requests. You can also upload an SSL client certificate (with the private key) for client authentication.

When configuring the Microsoft CA entity, you specify the CA certificate. You select the CA certificate from a list of all server certificates that are CA certificates. Likewise, when configuring client authentication, you can select from a list of all the server certificates for which XenMobile has the private key.

To import a keystore

By design, keystores, which are repositories of security certificates, can contain multiple entries. When loading from a keystore, therefore, you are prompted to specify the entry alias that identifies the entry you want to load. If you do not specify an alias, the first entry from the store is loaded. Because PKCS#12 files usually contain only one entry, the alias field does not appear when you select PKCS#12 as the keystore type.



1. In the XenMobile console, click the gear icon in the upper-right corner of the console. The **Settings** page appears.
2. Click **Certificates**. The **Certificates** page appears.







XenMobile Analyze Manage Configure   admin 

Settings > Certificates

Certificates

You must restart XenMobile on all nodes to commit and activate your changes to the SSL and Android for Work SAML certificates. To restart XenMobile, use the hypervisor console or command-line window.

 Import |  Add

<input type="checkbox"/>	Name	Description	Status	Valid from	Valid to	Type	Private key	
<input type="checkbox"/>	XMS.example.com	Self Signed/Generated	Up to date	2015-11-16	2025-11-13	SAML		
<input type="checkbox"/>	*.agsag.com		 Expired	2013-10-23	2015-10-23	SSL Listener		
<input type="checkbox"/>	cacerts.pem	Self Signed/Generated	Up to date	2015-11-16	2035-11-14	Devices CA		
<input type="checkbox"/>	ent-root-ca		Up to date	2012-02-22	2017-02-21	Root or intermediate		
<input type="checkbox"/>	APSP:3623302e-7c6e-4df8-aa91		 22 days left	2015-09-30	2016-09-29	APNs		

Showing 1 - 5 of 5 items

3. Click **Import**. The **Import** dialog box appears.

4. Configure these settings:

- **Import**: In the list, click **Keystore**. The **Import** dialog box changes to reflect available keystore options.

Import ×

You can import certificates or keystores used by PKI components. You can import several certificates, but you can only have one certificate active at a time.

Import Keystore ▼

Keystore type PKCS#12 ▼

Use as Server ▼

Keystore file* Browse

Password*

Description

Cancel
Import

- **Keystore type:** In the list, click **PKCS#12**.
- **Use as:** In the list, click how you plan to use the certificate. The available options are:
 - **Server.** Server certificates are certificates used functionally by the XenMobile Server that are uploaded to the XenMobile web console. They include CA certificates, RA certificates, and certificates for client authentication with other components of your infrastructure. In addition, you can use server certificates as storage for certificates you want to deploy to devices. This use especially applies to CAs used to establish trust on the device.
 - **SAML.** Security Assertion Markup Language (SAML) certification allows you to provide SSO access to servers, websites, and apps.
 - **APNs.** APNs certificates from Apple enable mobile device management via the Apple Push Network.
 - **SSL Listener.** The Secure Sockets Layer (SSL) Listener notifies XenMobile of SSL cryptographic activity.
- **Keystore file:** Browse to find the keystore you want to import of the file type .p12 (or .pfx on Windows-based computers).
- **Password:** Type the password assigned to the certificate.
- **Description:** Optionally, type a description for the keystore to help you distinguish it from your other keystores.

5. Click **Import**. The keystore is added to the Certificates table.

To import a certificate

When importing a certificate, either from a file or a keystore entry, XenMobile attempts to construct a certificate chain from the input, and imports all certificates in that chain (creating a server certificate entry for each). This operation only works if the certificates in the file or keystore entry do form a chain. For example, if each subsequent certificate in the

chain is the issuer of the previous certificate.

You can add an optional description for the imported certificate for heuristic purposes. The description only attaches to the first certificate in the chain. You can update the description of the remaining certificates later.

1. In the XenMobile console, click the gear icon in the upper-right corner of the console and then click **Certificates**.
2. On the **Certificates** page, click **Import**. The **Import** dialog box appears.
3. In the **Import** dialog box, in **Import**, if it is not already selected, click **Certificate**.
4. The **Import** dialog box changes to reflect available certificate options. In **Use as**, click how you will use the keystore. The available options are:
 - **Server**. Server certificates are certificates used functionally by the XenMobile Server that are uploaded to the XenMobile web console. They include CA certificates, RA certificates, and certificates for client authentication with other components of your infrastructure. In addition, you can use server certificates as storage for certificates you want to deploy to devices. This option especially applies to CAs used to establish trust on the device.
 - **SAML**. Security Assertion Markup Language (SAML) certification allows you to provide single sign-on (SSO) access to servers, websites, and apps.
 - **SSL Listener**. The Secure Sockets Layer (SSL) Listener notifies XenMobile of SSL cryptographic activity.
5. Browse to find the keystore you want to import of the file type .p12 (or .pfx on Windows-based computers).
6. Browse to find an optional private key file for the certificate. The private key is used for encryption and decryption along with the certificate.
7. Type a description for the certificate, optionally, to help you identify it from your other certificates.
8. Click **Import**. The certificate is added to the Certificates table.

Updating a certificate

XenMobile only allows one certificate per public key to exist in the system at any given time. If you attempt to import a certificate for the same key pair as an already imported certificate, you can either replace the existing entry or to delete the entry.

To most effectively update your certificates, in the XenMobile console, do the following. Click the gear icon on the upper-right corner of the console to open the **Settings** page and then click **Certificates**. In the **Import** dialog box, import the new certificate.

When you update a server certificate, components that were using the previous certificate automatically switch to using the new certificate. Likewise, if you have deployed the server certificate on devices, the certificate automatically updates on the next deployment.

XenMobile Certificate Administration

We recommend that you list the certificates you use in your XenMobile deployment, especially on their expiration dates and associated passwords. This section intends to help you make certificate administration in XenMobile easier.

Your environment may include some or all of the following certificates:

XenMobile Server

SSL Certificate for MDM FQDN

SAML Certificate (For ShareFile)

Root and Intermediate CA Certificates for the preceding certificates and any other internal resources (StoreFront/Proxy, and so on)

APN Certificate for iOS Device Management

Internal APNs Certificate for XenMobile Server Secure Hub Notifications

PKI User Certificate for connectivity to PKI

MDX Toolkit

Apple Developer Certificate

Apple Provisioning Profile (per application)

Apple APNs Certificate (for use with Citrix Secure Mail)

Android Keystore File

Windows Phone – Symantec Certificate

NetScaler

SSL Certificate for MDM FQDN

SSL Certificate for Gateway FQDN

SSL Certificate for ShareFile SZC FQDN

SSL Certificate for Exchange Load Balancing (offload configuration)

SSL Certificate for StoreFront Load Balancing

Root & Intermediate CA Certificates for the preceding certificates

XenMobile Certificate Expiration Policy

If you allow a certificate to expire, the certificate becomes invalid. You can no longer run secure transactions on your environment and you cannot access XenMobile resources.

Note

The Certification Authority (CA) prompts you to renew your SSL certificate prior to the expiration date.

APNs certificate for Citrix Secure Mail

Because the Apple Push Notification Service (APNs) certificates expire every year, create an APNs SSL certificate and update it in the Citrix portal before the certificate expires. If the certificate expires, users face inconsistency with Secure Mail push notifications. Also, you can no longer send push notifications for your apps.

APNs certificate for iOS device management

To enroll and manage iOS devices with XenMobile, set up and create an APNs certificate from Apple. If the certificate expires, users cannot enroll in XenMobile and you cannot manage their iOS devices. For details, see [APNs certificates](#).

You can view the APNs certificate status and expiration date by logging on to the Apple Push Certificates Portal. You must log on as the same user who created the certificate.

You also receive an email notification from Apple 30 and 10 days before the expiration date with the following information:

The following Apple Push Notification Service certificate, created for Apple ID CustomerID will expire on Date. Revoking or allowing this certificate to expire will require existing devices to be re-enrolled with a new push certificate.

Please contact your vendor to generate a new request (a signed CSR), then visit <https://identity.apple.com/pushcert> to renew your Apple Push Notification Service certificate.

Thank You,

Apple Push Notification Service

MDX Toolkit (iOS distribution certificate)

An app that runs on a physical iOS device (other than apps in the Apple App Store) must be signed with a provisioning profile. The app must also be signed with a corresponding distribution certificate.

To verify that you have a valid iOS distribution certificate, do the following:

1. From the Apple Enterprise Developer portal, create an explicit App ID for each app you plan to wrap with the MDX Toolkit. An example of an acceptable App ID is: com.CompanyName.ProductName.
2. From the Apple Enterprise Developer portal, go to **Provisioning Profiles > Distribution** and create an in-house provisioning profile. Repeat this step for each App ID created in the previous step.
3. Download all provisioning profiles. For details, see [Wrapping iOS Mobile Apps](#).

To confirm that all XenMobile Server certificates are valid, do the following:

1. In the XenMobile console, click **Settings** and then click **Certificates**.
2. Check that all certificates including APNs, SSL Listener, Root, and Intermediate certificate are valid.

Android keystore

The keystore is a file that contains certificates used to sign your Android app. When your key validity period expires, users can no longer seamlessly upgrade to new versions of your app.

Enterprise certificate from Symantec for Windows phones

Symantec is the exclusive provider of code signing certificates for Microsoft App Hub service. Developers and software publishers join App Hub to distribute Windows Phone and Xbox 360 applications for download through the Windows Marketplace. For details, see [Symantec Code Signing Certificates for Windows Phone](#) in the Symantec documentation.

If the certificate expires, Windows phone users cannot enroll. The users cannot install an app published and signed by the company, or start a company app that was installed on the phone.

NetScaler

For details on how to handle certificate expiration for NetScaler, see [How to handle certificate expiry on NetScaler](#) in the Citrix Support Knowledge Center.

An expired NetScaler certificate prevents users from enrolling and accessing the Store. The expired certificate also prevents users from connecting to Exchange Server when using Secure Mail. In addition, users cannot enumerate and open HDX apps (depending on which certificate expired).

The Expiry Monitor and Command Center can help you to track your NetScaler certificates. The Center notifies you when

the certificate expires. These tools assist to monitor the following NetScaler certificates:

- SSL Certificate for MDM FQDN
- SSL Certificate for Gateway FQDN
- SSL Certificate for ShareFile SZC FQDN
- SSL Certificate for Exchange Load Balancing (offload configuration)
- SSL Certificate for StoreFront Load Balancing
- Root and Intermediate CA Certificates for the preceding certificates

NetScaler Gateway and XenMobile

Jun 19, 2017

When you configure NetScaler Gateway using XenMobile, you establish the authentication mechanism for remote device access to the internal network. This functionality enables apps on a mobile device to access corporate servers located in the intranet. XenMobile creates a micro VPN from the apps on the device to NetScaler Gateway.

You configure NetScaler Gateway for use with XenMobile Server by exporting a script from XenMobile that you run on NetScaler Gateway. This article contains the following sections:

[Prerequisites for using the NetScaler Gateway configuration script](#)

[Configure authentication for remote device access to the internal network](#)

[Add a NetScaler Gateway instance](#)

[Configure NetScaler Gateway for use with XenMobile Server](#)

[Add a callback URL and NetScaler Gateway VPN virtual IP](#)

Prerequisites for using the NetScaler Gateway configuration script

NetScaler requirements:

- NetScaler (minimum version 11.0, Build 70.12).
- NetScaler IP address is configured and has connectivity to the LDAP server, unless LDAP is load balanced.
- NetScaler Subnet (SNIP) IP address is configured, has connectivity to the necessary back end servers, and has public network access over port 8443/TCP.
- DNS can resolve public domains.
- NetScaler is licensed with Platform/Universal or Trial licenses. For information, see <https://support.citrix.com/article/CTX126049>.
- A NetScaler Gateway SSL certificate is uploaded and installed on the NetScaler. For information see, <https://support.citrix.com/article/CTX136023>.

XenMobile requirements:

- XenMobile Server (minimum version 10.6).
- LDAP server is configured.

Configure authentication for remote device access to the internal network

1. In the XenMobile web console, click the gear icon in the upper-right corner of the console. The **Settings** page appears.

- Under **Server**, click **NetScaler Gateway**. The **NetScaler Gateway** page appears. In the following example, a NetScaler Gateway instance exists.

Settings > NetScaler Gateway

NetScaler Gateway

When you configure NetScaler Gateway, you configure the authentication mechanism for remote device access to the internal network. If you use NetScaler Gateway with StoreFront as the authentication server, you need to enable StoreFront as well.

Authentication ON

Deliver user certificate for authentication ON ?

Credential provider

Save

[Add](#) | [Edit](#) | [Export Configuration Script](#)

<input type="checkbox"/>	Name	Default	External URL	Logon Type	# of Callback URLs
<input checked="" type="checkbox"/>	testNS	<input checked="" type="checkbox"/>	https://testns.domain.com	Domain	0

Showing 1 - 1 of 1 items

- Configure these settings:

- **Authentication:** Select whether to enable authentication. The default is **ON**.
- **Deliver user certificate for authentication:** Select whether you want XenMobile to share the authentication certificate with Secure Hub so that the NetScaler Gateway handles client certificate authentication. The default is **OFF**.
- **Credential Provider:** In the list, click the credential provider to use. For more information, see [Credential Providers](#).

- Click **Save**.

Add a NetScaler Gateway instance

After you save the authentication settings, you add a NetScaler Gateway instance to XenMobile.

- In the XenMobile console, click the gear icon in the upper-right corner of the console. The **Settings** page opens.
- Under **Server**, click **NetScaler Gateway**. The **NetScaler Gateway** page appears.
- Click **Add**. The **Add New NetScaler Gateway** page appears.

Settings > NetScaler Gateway > Add New NetScaler Gateway

Add New NetScaler Gateway

Name*

Alias

External URL*

Logon Type

Password Required ON

Set as Default OFF

[Export Configuration Script](#)

Callback URL*	Virtual IP*	Add

[Cancel](#) [Save](#)

4. Configure these settings:

- **Name:** Type a name for the NetScaler Gateway instance.
- **Alias:** Optionally include an alias name for the NetScaler Gateway.
- **External URL:** Type the publicly accessible URL for NetScaler Gateway. For example, https://receiver.com.
- **Logon Type:** Choose a logon type. Types include **Domain only**, **Security token only**, **Domain and security token**, **Certificate**, **Certificate and domain**, and **Certificate and security token**. The default setting for the **Password Required** field changes based on the **Logon Type** you select. The default is **Domain only**.

If you have multiple domains, use **Certificate and domain**.

If you use **Certificate and security token**, some additional configuration is required on NetScaler Gateway to support Secure Hub. For information, see [Configuring XenMobile for Certificate and Security Token Authentication](#).

For more information, see [Authentication](#) in the Deployment Handbook.

- **Password Required:** Select whether you want to require password authentication. The default varies based on the **Logon Type** chosen.
- **Set as Default:** Select whether to use this NetScaler Gateway as the default. The default is **OFF**.
- **Export Configuration Script:** Click the button to export a configuration bundle that you upload to NetScaler Gateway to configure it with XenMobile settings. For information, see "Configure an on-premises NetScaler Gateway for use with XenMobile Server" after these steps.
- **Callback URL** and **Virtual IP:** Save your settings before adding these fields. For information, see "Add a callback URL and NetScaler Gateway VPN virtual IP" later in this article.

5. Click **Save**. The new NetScaler Gateway is added and appears in the table. You can edit or delete an instance by clicking the name in the list.

Configure NetScaler Gateway for use with XenMobile

Server

To configure an on-premises NetScaler Gateway for use with XenMobile Server, you perform the following general steps, detailed in this article:

1. Download a script and related files from XenMobile Server. See the readme file provided with the script for the latest detailed instructions.
2. Verify that your environment meets the prerequisites.
3. Update the script for your environment.
4. Run the script on NetScaler.
5. Test the configuration.

The script configures these NetScaler Gateway settings required by XenMobile:

- NetScaler Gateway virtual servers needed for MDM and MAM
- Session policies for the NetScaler Gateway virtual servers
- XenMobile Server details
- Authentication Policies and Actions for the NSG virtual server.

The script describes the LDAP configuration settings.

- Traffic actions and policies for the proxy server
- Clientless access profile
- Static local DNS record on NetScaler
- Other bindings: Service policy, CA certificate

The script doesn't handle the following configuration:

- Exchange load balancing
- ShareFile load balancing
- ICA Proxy configuration
- SSL Offload

To download, update, and run the script:

1. If you're adding a NetScaler Gateway, click **Export Configuration Script** on the **Add New NetScaler Gateway** page.

XenMobile Analyze Manage Configure administrator

Settings > NetScaler Gateway > Add New NetScaler Gateway

Add New NetScaler Gateway

Name*

Alias

External URL*

Logon Type

Password Required

Set as Default

[Export Configuration Script](#)

Callback URL*	Virtual IP*	Add

[Cancel](#) [Save](#)

Or, if you add a NetScaler Gateway instance and click **Save** before you export the script: Return to **Settings > NetScaler Gateway**, select the NetScaler, click **Export Configuration Script**, and then click **Download**.

XenMobile Analyze Manage Configure administrator

Settings > NetScaler Gateway

NetScaler Gateway

When you configure NetScaler Gateway, you configure the authentication mechanism for remote device access to the internal network. If you use NetScaler Gateway with StoreFront as the authentication server, you need to enable StoreFront as well.

Authentication

Deliver user certificate for authentication

Credential provider

[Save](#)

[Add](#) | [Edit](#) | [Export Configuration Script](#)

<input type="checkbox"/>	Name	Default	External URL	Logon Type	# of Callback URLs
<input checked="" type="checkbox"/>	testNS	<input checked="" type="checkbox"/>	https://testns.domain.com	Domain	0

Showing 1 - 1 of 1 items

After you click **Export Configuration Script**, XenMobile creates a .tar.gz script bundle. The script bundle includes:

- Readme file with detailed instructions
- Script that contains the NetScaler CLI commands used to configure the required components in NetScaler
- Public Root CA certificate and the Intermediate CA certificate of XenMobile Server (these certificates, for SSL offload, are not needed for the current release)
- Script that contains the NetScaler CLI commands used to remove the NetScaler configuration

2. Edit the script (NSGConfigBundle_CREATESCRIPT.txt) to replace all placeholders with details from your environment.

```
# <LDAP_SECURE_PORT> -- LDAP Server Secure Port.
# <NSG_ROOT_CA_CERT_TAG> -- NetScaler ROOT CA Tag.
# <RADIUS_KEY> -- Radius Key.
# <XMS_CERT_TAG> -- XenMobile Certificate Tag.
# <MAM_LB_IP> -- Virtual IP Address to be assigned for MAM Load-Balancer and this IP must follow the RFC 1918 standard o
f private IP addresses.
# <MDM_LB_IP> -- Virtual IP Address to be assigned for MDM Load-Balancer and this IP must follow the RFC 1918 standard o
f private IP addresses.
# <RADIUS_SERVER_IP> -- Radius Server IP Address.
# <LDAP_PASSWORD> -- LDAP Service Account Password.
# <NS_SERVER_CERT_TAG> -- NetScaler Server Certificate Tag.
# <NSG_UIP> -- Virtual IP Address to be assigned to the NetScaler Gateway virtual server. This IP address must be reacha
ble from your devices either directly or via a NAT.
```

3. Run your edited script in the NetScaler bash shell, as described in the readme file included in the script bundle. For example:

```
/netscaler/nscli -U :<NetScaler Management Username>:<NetScaler Management Password> batch -f
"/var/NSGConfigBundle_CREATESCRIPT.txt"
```

```
login as: nsroot
#####
#
#      WARNING: Access to this system is for authorized users only
#      Disconnect IMMEDIATELY if you are not an authorized user!
#
#####

Using keyboard-interactive authentication.
Password:
Last login: Thu Feb 16 10:10:29 2017 from 10.0.1.121
Done
> shell
Copyright (c) 1992-2013 The FreeBSD Project.
Copyright (c) 1979, 1980, 1983, 1986, 1988, 1989, 1991, 1992, 1993, 1994
    The Regents of the University of California. All rights reserved.

root@ns# /netscaler/nscli -U :nsroot:nsroot batch -f "/var/NSGConfigBundle_CREATESCRIPT.txt"
```

When the script completes, the following lines appear.

```
exec: save ns config
Done
Done
root@ns# █
```

Test the configuration

1. Validate that the NetScaler Gateway Virtual Server shows a state of **UP**.

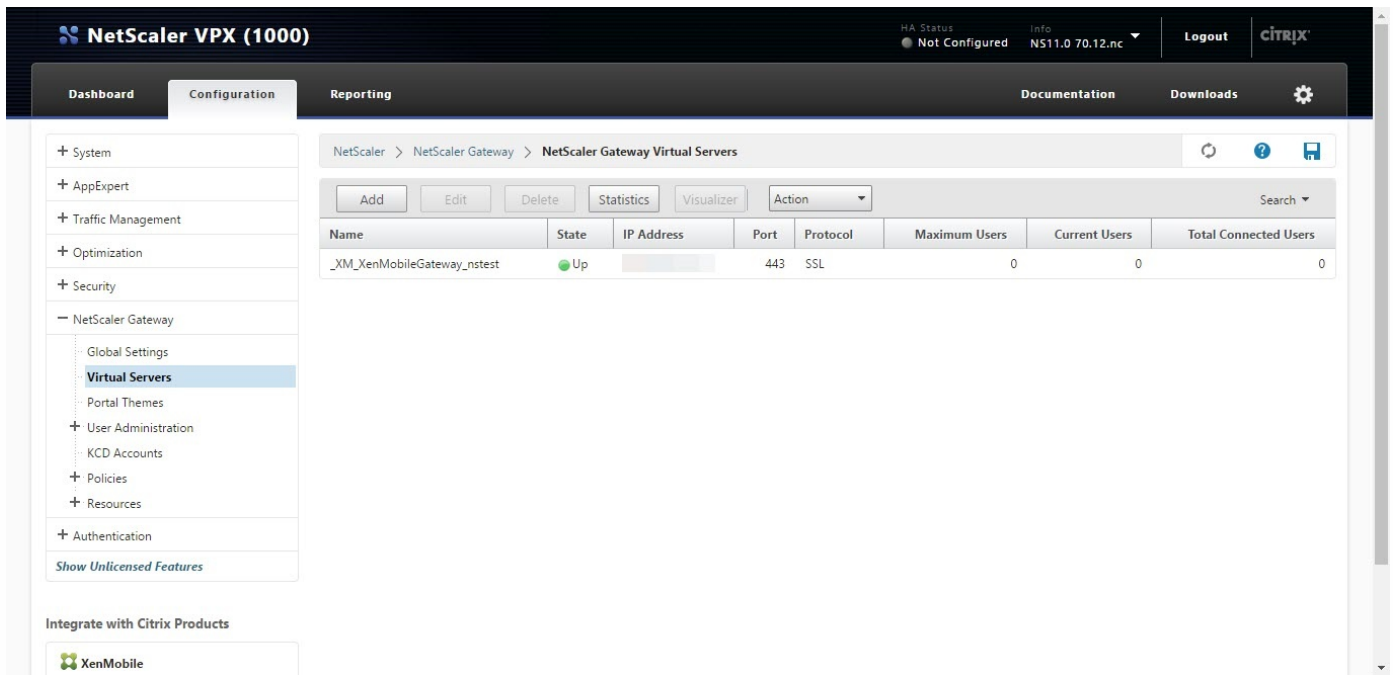

2. Validate that the Proxy Load Balancing Virtual Server shows a state of **UP**.

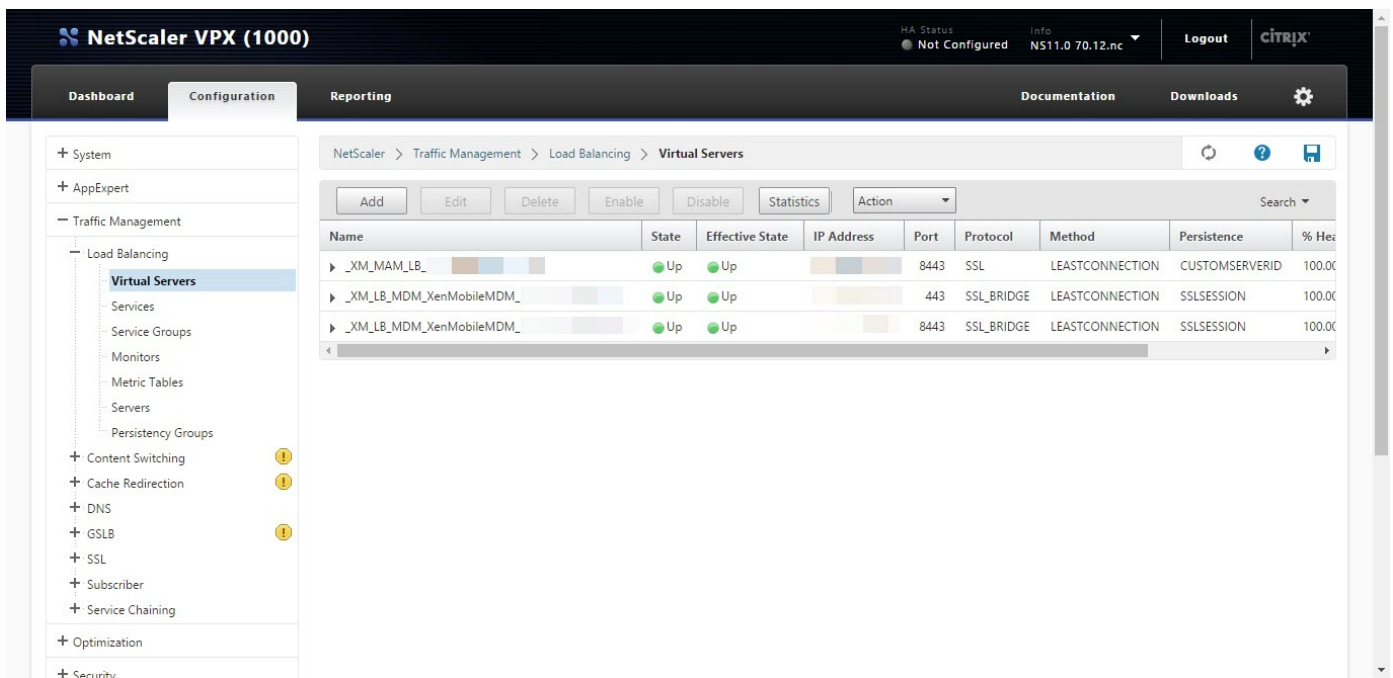

3. Open a web browser, connect to the NetScaler Gateway URL, and attempt to authenticate. If the authentication fails, this message appears: HTTP Status 404 - Not Found

4. Enroll a device and ensure it gets both MDM and MAM enrollment.

Add a callback URL and NetScaler Gateway VPN virtual

IP

After adding the NetScaler Gateway instance, you can add a callback URL and specify a NetScaler Gateway virtual IP address. **Note:** These settings are optional, but can be configured for extra security, especially when the XenMobile Server is in the DMZ.

1. In **Settings > NetScaler Gateway**, select the NetScaler Gateway and then click **Edit**.
2. In the table, click **Add**.
3. For **Callback URL** type the fully qualified domain name (FQDN). The callback URL verifies that a request originated from NetScaler Gateway. Ensure that the callback URL resolves to an IP address that is reachable from XenMobile Server. The callback URL can be an external NetScaler Gateway URL or some other URL.
4. Type the NetScaler Gateway **Virtual IP** address and then click **Save**.

Domain or domain plus security token authentication

Jun 19, 2017

XenMobile supports domain-based authentication against one or more directories, such as Active Directory, that are compliant with the Lightweight Directory Access Protocol (LDAP). You can configure a connection in XenMobile to one or more directories and then use the LDAP configuration to import groups, user accounts, and related properties. LDAP is an open source, vendor-neutral application protocol for accessing and maintaining distributed directory information services over an Internet Protocol (IP) network. Directory information services are used to share information about users, systems, networks, services, and applications available throughout the network. A common usage of LDAP is to provide single sign-on (SSO) for users, where a single password (per user) is shared among multiple services, enabling a user to log on one time to a company website, and then be automatically logged into the corporate intranet. A client starts an LDAP session by connecting to an LDAP server, referred to as a Directory System Agent (DSA). The client then sends an operation request to the server, and the server responds with the appropriate authentication. To add LDAP connections in XenMobile

1. In the XenMobile console, click the gear icon in the upper-right corner of the console. The **Settings** page appears.
2. Under **Server**, click **LDAP**. The **LDAP** page appears. You can [add](#), [edit](#), or [delete](#) LDAP-compliant directories from this page.

The screenshot shows the XenMobile console interface. At the top, there is a navigation bar with 'XenMobile' and tabs for 'Analyze', 'Manage', and 'Configure'. On the right, there is a gear icon and a user profile 'admin'. Below the navigation bar, the breadcrumb 'Settings > LDAP' is visible. The main heading is 'LDAP' with a sub-heading: 'Provides connection to one or more LDAP-compliant directories, such as Active Directory, to import groups, user accounts, and related properties.' There is a toggle for 'Support nested groups' set to 'NO'. Below this is an 'Add' button with a plus icon. A table lists the configured LDAP directories:

<input type="checkbox"/>	Directory Type	Domain Name	Server:Port	User Base DN	Group Base DN	Default	▼
<input type="checkbox"/>	Microsoft Active Directory	agsag.com	10.199.225.101:389	dc=agsag,dc=com	dc=agsag,dc=com	✓	

Showing 1 - 1 of 1 items

To add an LDAP-compliant directory

1. On the **LDAP** page, click **Add**. The **Add LDAP** page appears.

XenMobile Analyze Manage Configure admin

Settings > LDAP > Add LDAP

Add LDAP

Provides connection to one or more LDAP-compliant directories, such as Active Directory, to import groups, user accounts, and related properties.

Directory type*	Microsoft Active Directory	
Primary server*	IP Address or FQDN	
Secondary server	IP Address or FQDN	
Port*	389	
Domain name*		
User base DN*	dc=example,dc=com	?
Group base DN*	dc=example,dc=com	?
User ID*		
Password*		
Domain alias*		
XenMobile Lockout Limit	0	?
XenMobile Lockout Time	1	?
Global Catalog TCP Port	3268	?
Global Catalog Root Context	dc=example,dc=com	?
User search by	userPrincipalName	
Use secure connection	NO	

Cancel Save

2. Configure these settings:

- **Directory type:** In the list, click the appropriate directory type. The default is **Microsoft Active Directory**.
- **Primary server:** Type the primary server used for LDAP; you can enter either the IP address or the fully qualified domain name (FQDN).
- **Secondary server:** Optionally, if a secondary server has been configured, enter the IP address or FQDN for the secondary server. This server is a failover server used if the primary server cannot be reached.
- **Port:** Type the port number used by the LDAP server. By default, the port number is set to 389 for unsecured LDAP

connections. Use port number 636 for secure LDAP connections, use 3268 for Microsoft unsecure LDAP connections, or 3269 for Microsoft secure LDAP connections.

- **Domain name:** Type the domain name.
- **User base DN:** Type the location of users in Active Directory through a unique identifier. Syntax examples include: ou=users, dc=example, or dc=com.
- **Group base DN:** Type the location of groups in Active Directory. For example, cn=users, dc=domain, dc=net where cn=users represents the container name of the groups and dc represents the domain component of Active Directory.
- **User ID:** Type the user ID associated with the Active Directory account.
- **Password:** Type the password associated with the user.
- **Domain alias:** Type an alias for the domain name.
- **XenMobile Lockout Limit:** Type a number between 0 and 999 for the number of failed logon attempts. Setting this field to 0 means that XenMobile will never lock out the user based on failed logon attempts.
- **XenMobile Lockout Time:** Type a number between 0 and 99999 representing the number of minutes a user must wait after exceeding the lockout limit. Setting this field to 0 means that the user will not be forced to wait after a lockout.
- **Global Catalog TCP Port:** Type the TCP port number for the Global Catalog server. By default, the TCP port number is set to 3268; for SSL connections, use port number 3269.
- **Global Catalog Root Context:** Optionally, type the Global Root Context value used to enable a global catalog search in Active Directory. This search is in addition to the standard LDAP search, in any domain without the need to specify the actual domain name.
- **User search by:** In the list, click either **userPrincipalName**, or **sAMAccountName**. The default is **userPrincipalName**.
- **Use secure connection:** Select whether to use secure connections. The default is **NO**.

3. Click **Save**.

To edit an LDAP-compliant directory

1. In the **LDAP** table, select the directory you want to edit.

Note: When you select the check box next to a directory, the options menu appears above the LDAP list; when you click anywhere else in the list, the options menu appears on the right side of the listing.

2. Click **Edit**. The **Edit LDAP** page appears.

Settings > LDAP > Add LDAP

Edit LDAP

Provides connection to one or more LDAP-compliant directories, such as Active Directory, to import groups, user accounts, and related properties.

Directory type*	Microsoft Active Directory	
Primary server*	10.61	
Secondary server	IP Address or FQDN	
Port*	389	
Domain name*	.net	
User base DN*	dc=,dc=net	?
Group base DN*	dc=,dc=net	?
User ID*	administrator@.net	
Password*		
Domain alias*	.net	
XenMobile Lockout Limit	0	?
XenMobile Lockout Time	1	?
Global Catalog TCP Port	3268	?
Global Catalog Root Context	dc=example,dc=com	?
User search by	userPrincipalName	
Use secure connection	<input type="radio"/> NO	

3. Change the following information as appropriate:

- **Directory type:** In the list, click the appropriate directory type..
- **Primary server:** Type the primary server used for LDAP; you can enter either the IP address or the fully qualified domain name (FQDN).
- **Secondary server:** Optionally, type the IP address or FQDN for the secondary server (if one has been configured).
- **Port:** Type the port number used by the LDAP server. By default, the port number is set to 389 for unsecured LDAP connections. Use port number 636 for secure LDAP connections, use 3268 for Microsoft unsecure LDAP connections, or 3269 for Microsoft secure LDAP connections.
- **Domain name:** You cannot change this field.
- **User base DN:** Type the location of users in Active Directory through a unique identifier. Syntax examples include: ou=users, dc=example, or dc=com.
- **Group base DN:** Type the group base DN group name specified as cn=groupname. For example, cn=users, dc=servername, dc=net where cn=users is the group name; DN and servername represents the name of the server running Active Directory.
- **User ID:** Type the user ID associated with the Active Directory account.
- **Password:** Type the password associated with the user.
- **Domain alias:** Type an alias for the domain name.
- **XenMobile Lockout Limit:** Type a number between 0 and 999 for the number of failed logon attempts. Setting this field to 0 means that XenMobile will never lock out the user based on failed logon attempts.
- **XenMobile Lockout Time:** Type a number between 0 and 99999 representing the number of minutes a user must wait after exceeding the lockout limit. Setting this field to 0 means that the user will not be forced to wait after a lockout.
- **Global Catalog TCP Port:** Type the TCP port number for the Global Catalog server. By default, the TCP port number is set to 3268; for SSL connections, use port number 3269.
- **Global Catalog Root Context:** Optionally, type the Global Root Context value used to enable a global catalog search in

Active Directory. This search is in addition to the standard LDAP search, in any domain without the need to specify the actual domain name.

- **User search by:** In the list, click either **userPrincipalName**, or **sAMAccountName**.
- **Use secure connection:** Select whether to use secure connections.

4. Click **Save** to save your changes or **Cancel** to leave the property unchanged.

To delete an LDAP-compliant directory

1. In the **LDAP** table, select the directory you want to delete.

Note: You can select more than one property to delete by selecting the check box next to each property.

2. Click **Delete**. A confirmation dialog box appears. Click **Delete** again.

Configure domain plus security token authentication

You can configure XenMobile to require users to authenticate with their LDAP credentials plus a one-time password, using the RADIUS protocol.

For optimal usability, you can combine this configuration with Citrix PIN and Active Directory password caching so users do not have to repeatedly enter their Active Directory user names and passwords. Users will need to enter user names and passwords for enrollment, password expiration, and account lockout.

Configure LDAP settings

Use of LDAP for authentication requires that you install an SSL certificate from a Certificate Authority on XenMobile. For information, see [Uploading certificates in XenMobile](#).

1. In **Settings**, click **LDAP**.
2. Select **Microsoft Active Directory** and then click **Edit**.

The screenshot shows the XenMobile configuration interface for LDAP. The breadcrumb is 'Settings > LDAP'. The title is 'LDAP' with a subtitle: 'Provides connection to one or more LDAP-compliant directories, such as Active Directory, to import groups, user accounts, and related properties.' There is a toggle for 'Support nested groups' set to 'NO'. Below are icons for 'Add', 'Edit', and 'Delete'. A table lists the configured directory:

<input type="checkbox"/>	Directory Type	Domain Name	Server:Port	User Base DN	Group Base DN	Default
<input checked="" type="checkbox"/>	Microsoft Active Directory	xmlab.net	10.207.86.51:389	dc=xmlab,dc=net	dc=xmlab,dc=net	✓

3. Verify that the Port is 636, which is for secure LDAP connections, or 3269 for Microsoft secure LDAP connections.

4. Change **Use secure connection** to **Yes**.

XenMobile Analyze Manage Configure admin

Port* 636

Domain name* .net

User base DN* dc=.net

Group base DN* dc=.net

User ID* administrator@.net

Password*

Domain alias* .net

XenMobile Lockout Limit 0

XenMobile Lockout Time 1

Global Catalog TCP Port 3269

Global Catalog Root Context dc=example,dc=com

User search by userPrincipalName

Use secure connection

Cancel Save

Configure NetScaler Gateway settings

The following steps assume that you already have added a NetScaler Gateway instance to XenMobile. To add a NetScaler Gateway instance, see [To configure a new NetScaler Gateway instance](#).

1. In **Settings**, click **NetScaler Gateway**.
2. Select the **NetScaler Gateway** and then click **Edit**.
3. From **Logon Type**, select **Domain and security token**.

XenMobile Analyze Manage Configure admin

Settings > NetScaler Gateway > Add New NetScaler Gateway

Add New NetScaler Gateway

Name* THAG

Alias

External URL* https://ag-bm1.xs.citrix.com

Logon Type Domain and security token

Password Required

Set as Default

Callback URL*	Virtual IP*	<input type="button" value="Add"/>
---------------	-------------	------------------------------------

Enable Citrix PIN and user password caching

To enable Citrix PIN and user password caching, go to **Settings > Client Properties** and select these check boxes: **Enable Citrix PIN Authentication** and **Enable User Password Caching**. For more information, see [Client properties](#).

Configure NetScaler Gateway for domain and security token authentication

Configure NetScaler Gateway session profiles and policies for your virtual servers used with XenMobile. For information, see [Configuring Domain and Security Token Authentication for XenMobile](#) in the NetScaler Gateway documentation.

Client certificate or certificate plus domain authentication

Jun 19, 2017

The default configuration for XenMobile is user name and password authentication. To add another layer of security for enrollment and access to XenMobile environment, consider using certificate-based authentication. In the XenMobile environment, this configuration is the best combination of security and user experience, with the best SSO possibilities coupled with security provided by two-factor authentication at NetScaler.

If you don't allow LDAP and use smart cards or similar methods, configuring certificates allows you to represent a smart card to XenMobile. Users then enroll using a unique PIN that XenMobile generates for them. After a user has access, XenMobile creates and deploys the certificate subsequently used to authenticate to the XenMobile environment.

You can use the NetScaler for XenMobile wizard to perform the configuration required for XenMobile when using NetScaler certificate-only authentication or certificate plus domain authentication. You can run the NetScaler for XenMobile wizard one time only.

In highly secure environments where usage of LDAP credentials outside of an organization in public or insecure networks is considered a prime security threat for the organization, two-factor authentication using a client certificate and a security token is an option. For information, see [Configuring XenMobile for Certificate and Security Token Authentication](#).

Client certificate authentication is available for XenMobile MAM mode (MAM-only) and ENT mode (when users enroll into MDM). Client certificate authentication isn't available for XenMobile ENT mode when users enroll into legacy MAM mode. To use client certificate authentication for XenMobile ENT and MAM modes, you must configure the Microsoft server, the XenMobile server, and then NetScaler Gateway. Follow these general steps, as described in this article.

On the Microsoft server:

1. Add a certificate snap-in to the Microsoft Management Console.
2. Add the template to Certificate Authority (CA).
3. Create a PFX certificate from the CA server.

On the XenMobile server:

1. Upload the certificate to XenMobile.
2. Create the PKI entity for certificate-based authentication.
3. Configure credentials providers.
4. Configure NetScaler Gateway to deliver a user certificate for authentication.

On NetScaler Gateway, configure as described in [Configuring Client Certificate or Client Certificate and Domain Authentication](#) in the NetScaler Gateway documentation.

Prerequisites

- When you create a Microsoft Certificate Services Entity template, to avoid possible authentication issues with enrolled devices, avoid using special characters, such as ;, !, \$, (), #, %, +, *, ~, ?, |, {}, and [] in the template name.

- For Windows Phone 8.1 devices using client certificate authentication and SSL Offload, you must disable SSL session reuse for port 443 on both load balancing virtual servers in NetScaler. To do that, Run the following command on the vservers for port 443:

```
set ssl vserver <ssl lb vserver> sessReuse DISABLE
```

Note: Disabling SSL session reuse disables some of the optimizations that NetScaler provides, which can result in a performance decrease on the NetScaler.

- To configure Certificate-based Authentication for Exchange ActiveSync, see this [Microsoft blog](#).
- If you are using private server certificates to secure the ActiveSync traffic to the Exchange Server, ensure that the mobile devices have all of the Root/Intermediate certificates. Otherwise, certificate-based authentication will fail during the mailbox setup in Secure Mail. In the Exchange IIS Console, you must:
 - Add a website for XenMobile use with Exchange and bind the web server certificate.
 - Use port 9443.
 - For that website, you must add two applications, one for "Microsoft-Server-ActiveSync" and one for "EWS". For both of those applications, under **SSL Settings**, select **Require SSL**.
- Make sure that Secure Mail is wrapped with the latest MDX Toolkit, if required for your deployment method.

Add a certificate snap-in to the Microsoft Management Console

1. Open the console and then click **Add/Remove Snap-Ins**.
2. Add the following snap-ins:

- Certificate Templates**
- Certificates (Local Computer)**
- Certificates - Current User**
- Certificate Authority (Local)**

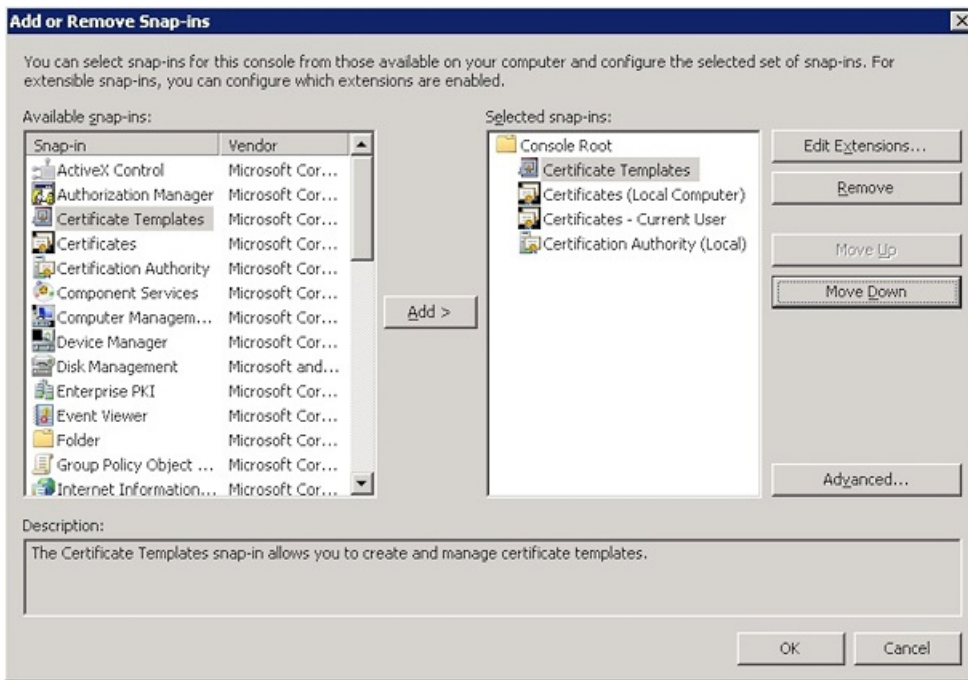

3. Expand **Certificate Templates**.

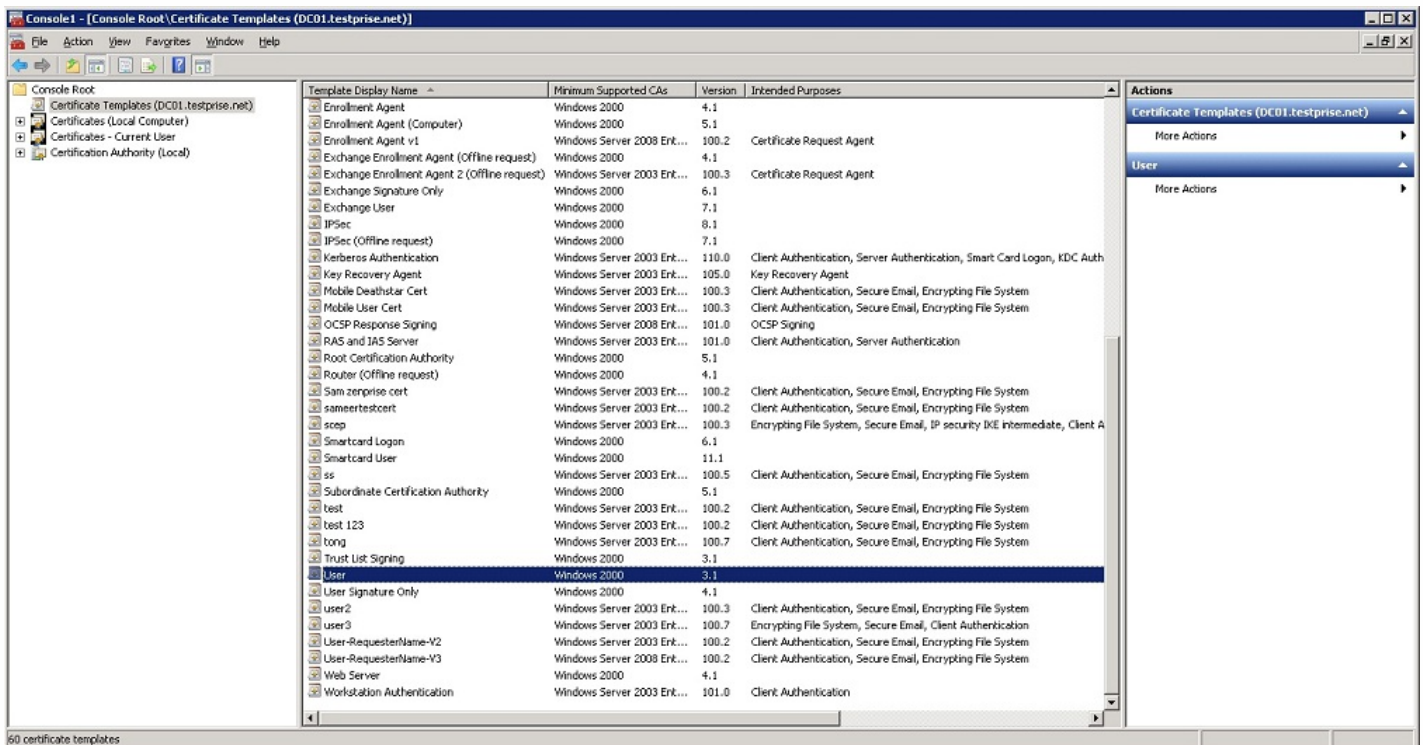

4. Select the **User** template and **Duplicate Template**.

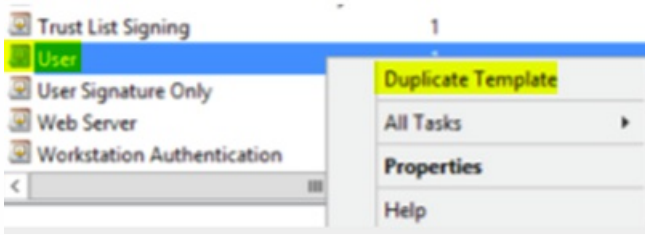

5. Provide the Template display name.

Important: Do not select the **Publish certificate in Active Directory** check box unless required. If this option is selected, all user client certificates will be pushed/created in Active Directory, which might clutter your Active Directory database.

6. Select **Windows 2003 Server** for the template type. In Windows 2012 R2 server, under **Compatibility**, select **Certificate authority** and set the recipient as **Windows 2003**.

7. Under **Security**, select the **Enroll** option in the **Allow** column for the authenticated users.

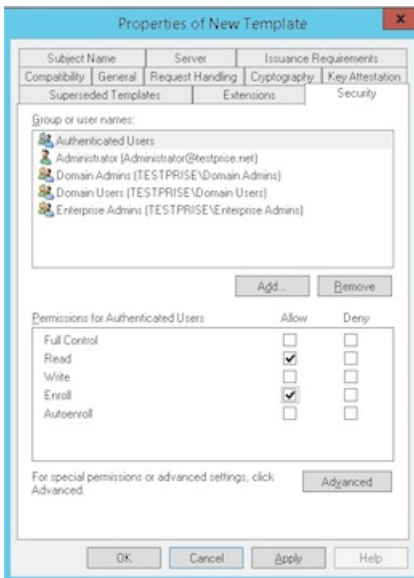

8. Under **Cryptography**, make sure you provide the key size, which you will need to enter during XenMobile configuration.

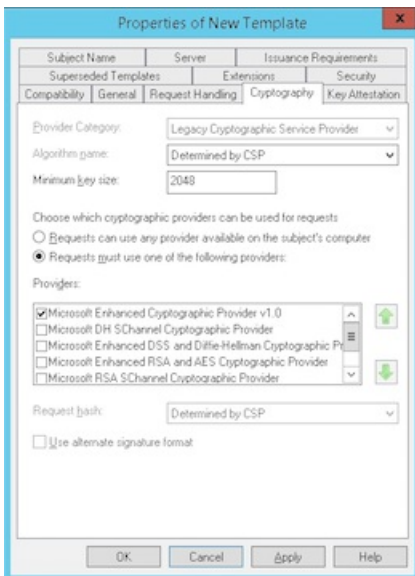

9. Under **Subject Name**, select **Supply in the request**. Apply the changes and then save.

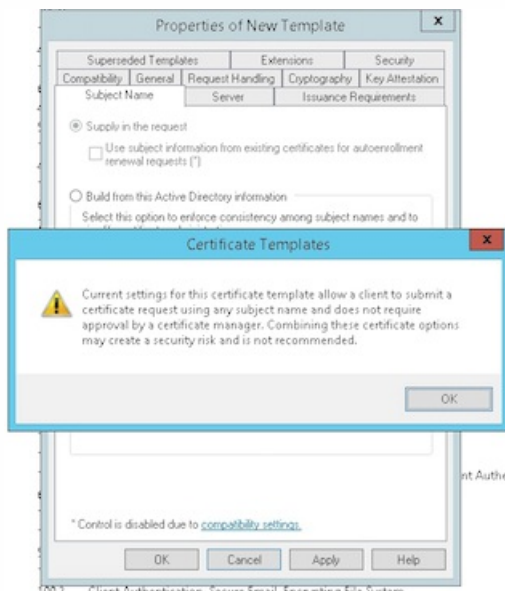

Adding the template to Certificate Authority

1. Go to **Certificate Authority** and select **Certificate Templates**.
2. Right-click in the right pane and then select **New > Certificate Template to Issue**.

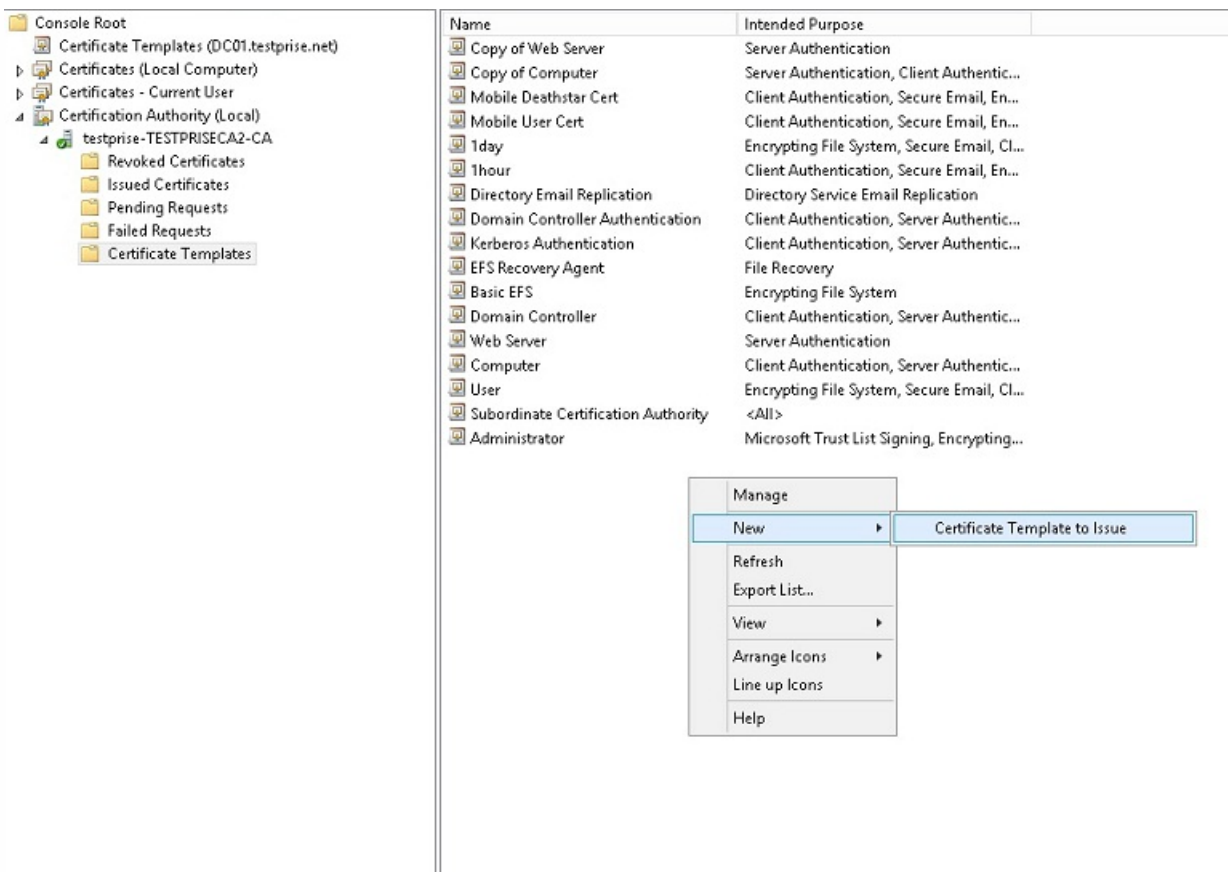

3. Select the template you created in the previous step and then click **OK** to add it into the **Certificate Authority**.

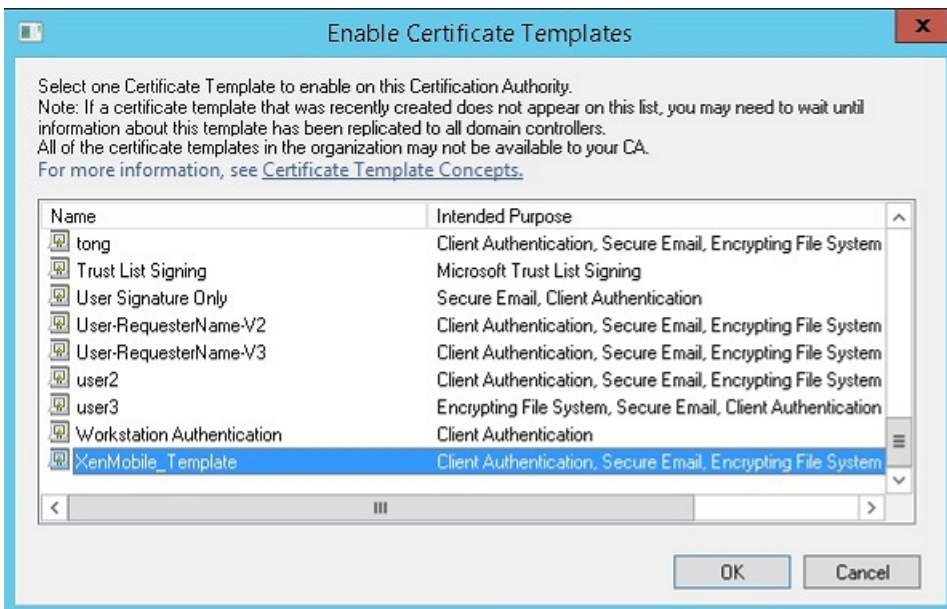

Creating a PFX certificate from the CA server

1. Create a user .pfx cert using the service account with which you logged in. This .pfx will be uploaded into XenMobile,

which will request a user certificate on behalf of the users who enroll their devices.

2. Under **Current User**, expand **Certificates**.

3. Right-click in the right pane and then click **Request New Certificate**.

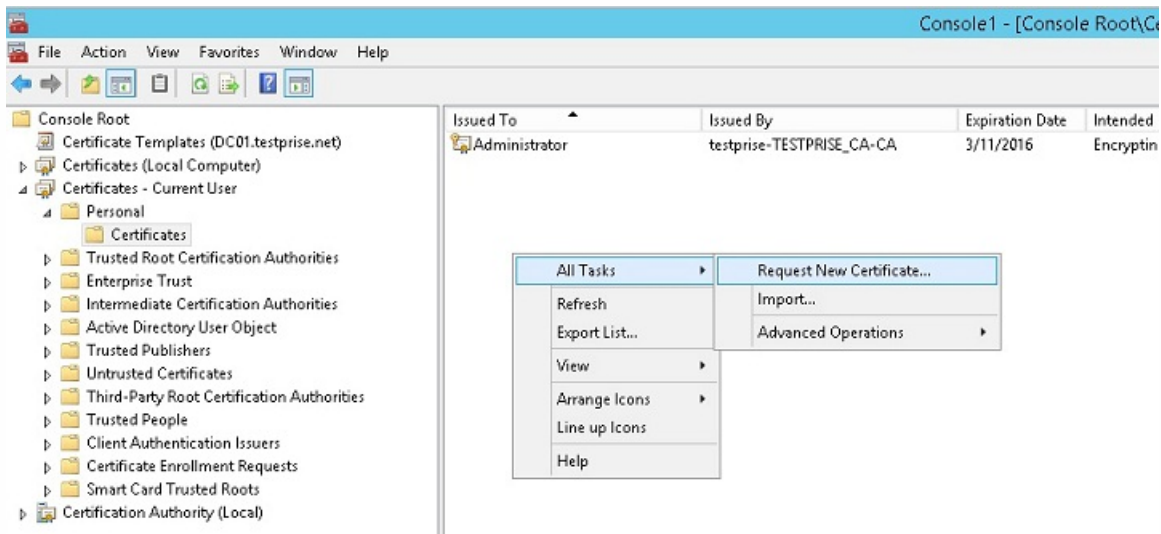

4. The **Certificate Enrollment** screen appears. Click **Next**.

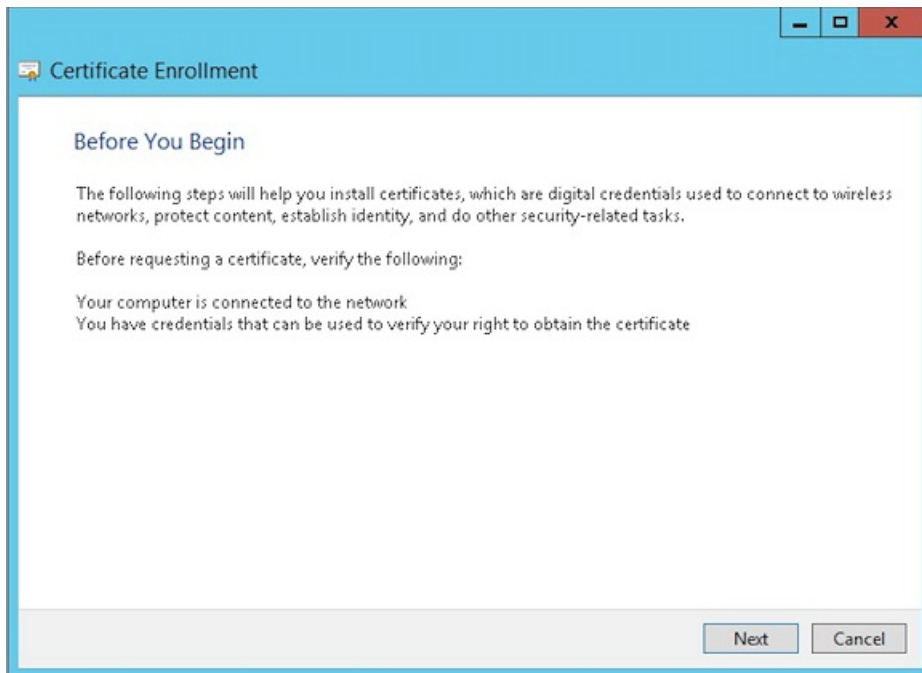

5. Select **Active Directory Enrollment Policy** and then click **Next**.

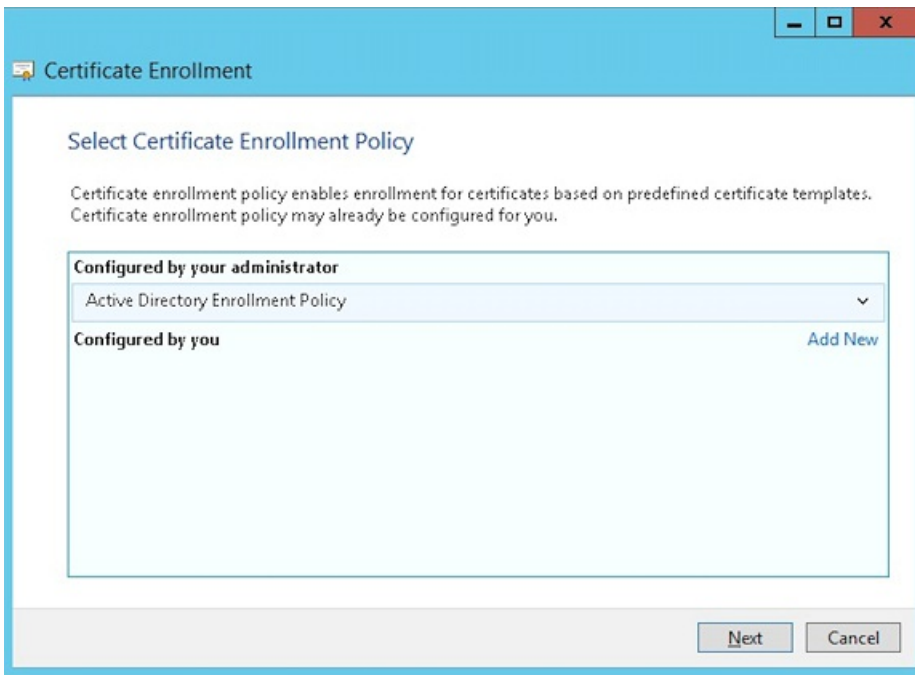

6. Select the **User** template and then click **Enroll**.

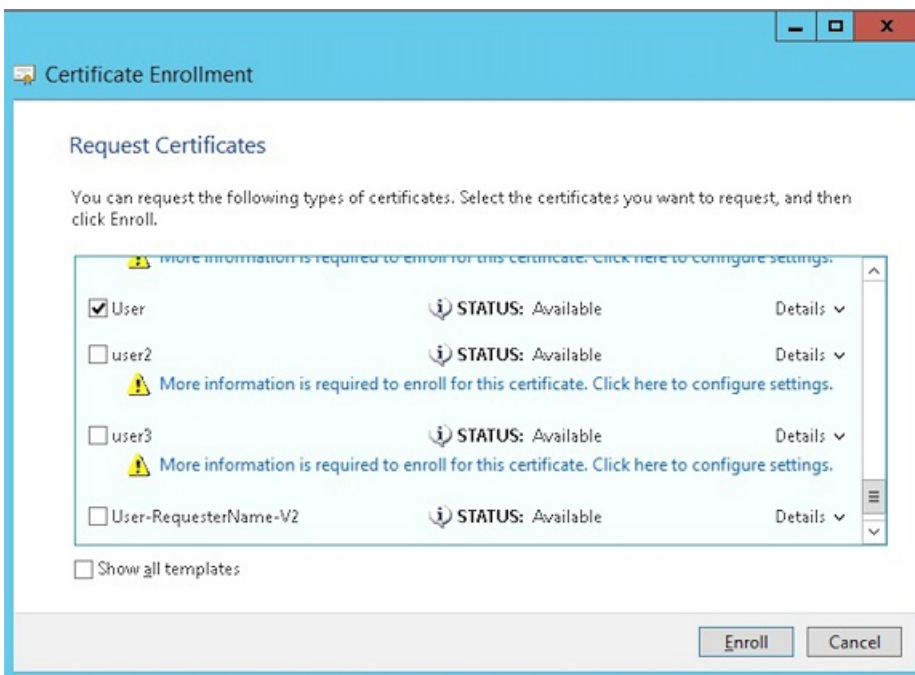

7. Export the .pfx file that you created in the previous step.

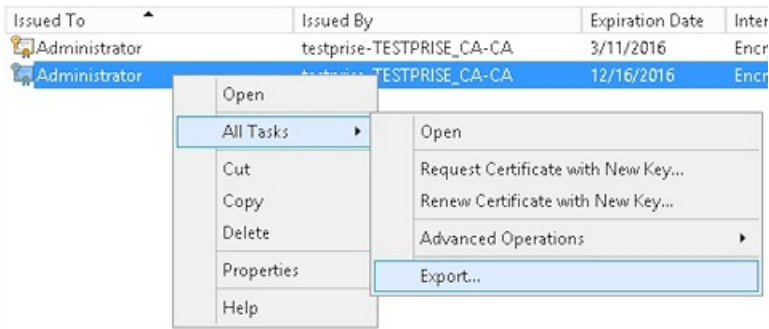

8. Click **Yes**, export the private key.

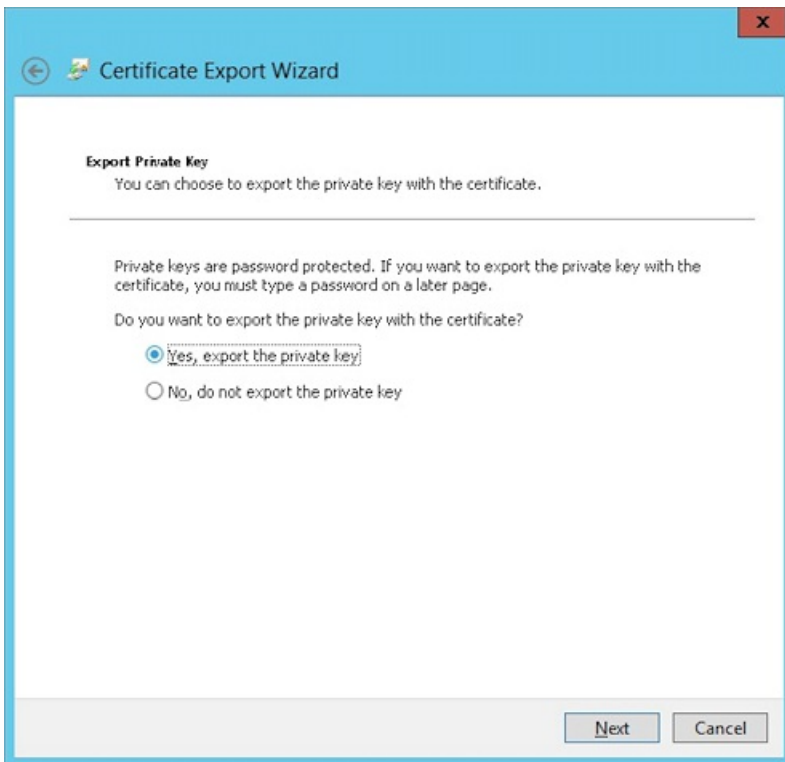

9. Select **Include all certificates in the certification path if possible** and select the **Export all extended properties** check box.

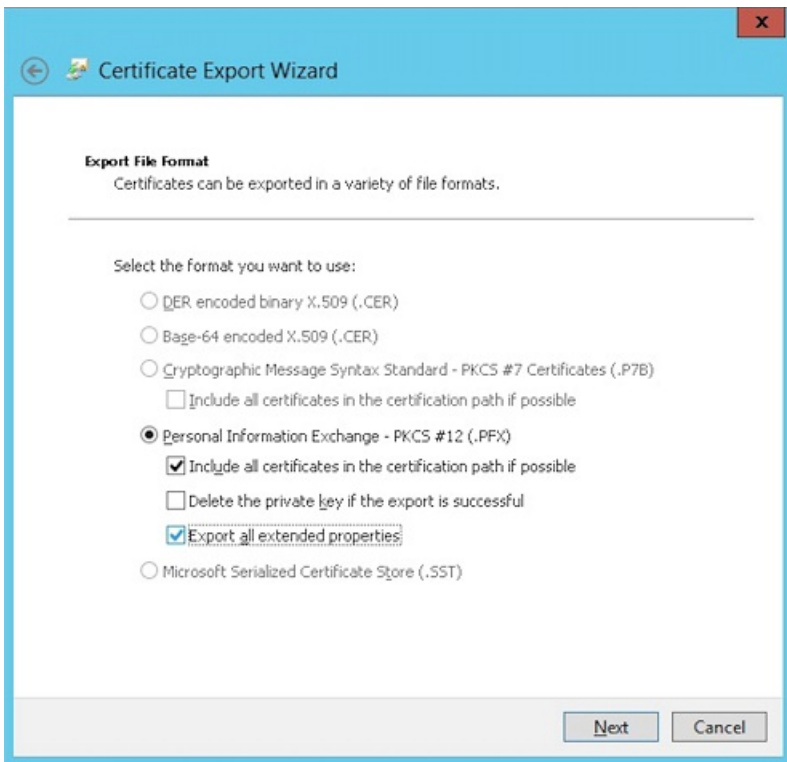

10. Set a password that you'll use when uploading this certificate into XenMobile.

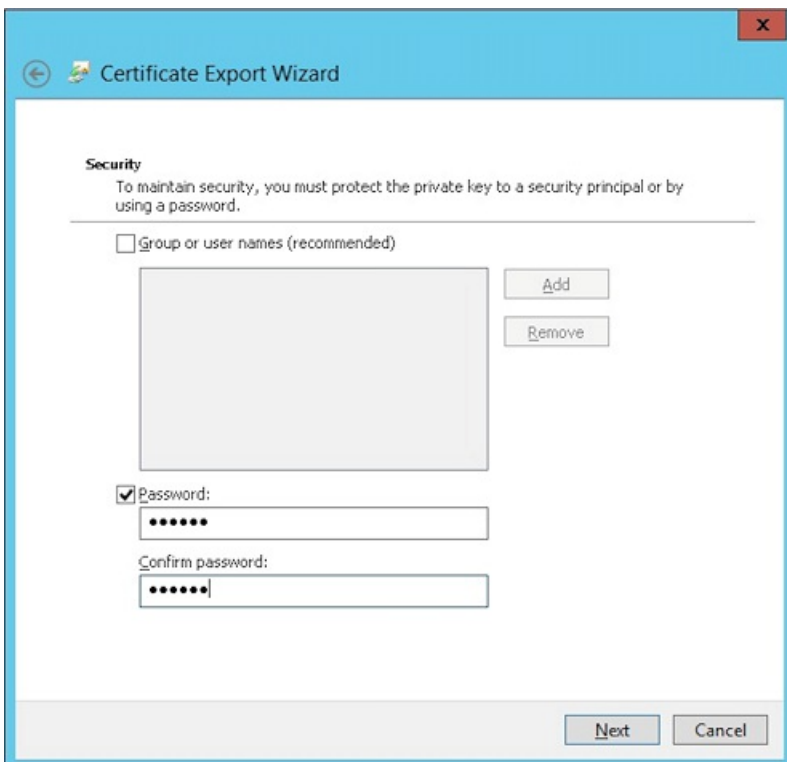

11. Save the certificate onto your hard drive.

Uploading the certificate to XenMobile

1. In the XenMobile console, click the gear icon in the upper-right corner. The **Settings** screen appears.

2. Click **Certificates** and then click **Import**.

3. Enter the following parameters:

- **Import:** Keystore
- **Keystore type:** PKCS#12
- **Use as:** Server
- **Keystore file:** Click Browse to select the .pfx certificate you just created.
- **Password:** Enter the password you created for this certificate.

Import ×

You can import certificates or keystores used by PKI components. You can import several certificates, but you can only have one certificate active at a time.

Import Keystore

Keystore type PKCS#12

Use as Server

Keystore file* **Browse**

Password*

Description

Cancel **Import**

4. Click **Import**.

5. Verify that the certificate installed correctly. It should display as a User certificate.

Creating the PKI entity for certificate-based authentication

1. In **Settings**, go to **More > Certificate Management > PKI Entities**.

2. Click **Add** and then click **Microsoft Certificate Services Entity**. The **Microsoft Certificate Services Entity: General Information** screen appears.

3. Enter the following parameters:

- **Name:** Type any name
- **Web enrollment service root URL:** https://RootCA-URL/certsrv/
Be sure to add the last slash (/) in the URL path.
- **certnew.cer page name:** certnew.cer (default value)
- **certfnsh.asp:** certfnsh.asp (default value)
- **Authentication type:** Client certificate
- **SSL client certificate:** Select the User Certificate to be used to issue the XenMobile client certificate.

Settings > PKI Entities > Microsoft Certificate Services Entity

Microsoft Certificate Services Entity

- 1 General
- 2 Templates
- 3 HTTP Parameters
- 4 CA Certificates

Microsoft Certificate Services Entity: General Information

Name*

Web enrollment service root URL*

certnew.cer page name*

certfnsh.asp*

Authentication type

SSL client certificate

4. Under **Templates**, add the template that you created when configuring the Microsoft certificate. Be sure not to add spaces.

Microsoft Certificate Services Entity

- 1 General
- 2 Templates
- 3 HTTP Parameters
- 4 CA Certificates

Microsoft Certificate Services Entity: Templates

Specify the internal names of the templates your Microsoft CA supports. Every Credential Provider using this entity uses exactly one such template. When creating the provider, you will be prompted to select from the list defined here.

Templates*	<input type="button" value="Add"/>
XMTemplate	

5. Skip HTTP Parameters and then click **CA Certificates**.

6. Select the root CA name that corresponds to your environment. This root CA is part of the chain imported from the XenMobile client certificate.

Microsoft Certificate Services Entity: CA Certificates

Indicate the certificates you want to use for this entity by selecting or clearing the check boxes. An entity is only valid when you select at least one certificate. Add all CA certificates that might be signers of certificates returned by this entity. Although entities may return certificates signed by different CAs, all certificates obtained through a given credential provider must be signed by the same CA. Accordingly, you will have to select one of the certificates configured here in the Distribution page of the Credential Provider setting.

<input type="checkbox"/>	Name	Serial number	Valid from	Valid to
<input checked="" type="checkbox"/>	training-AD-CA	14	02/22/2013	02/22/2023

7. Click **Save**.

Configuring credentials providers

1. In **Settings**, go to **More > Certificate Management > Credential Providers**.

2. Click **Add**.

3. Under **General**, enter the following parameters:

- **Name:** Type any name.
- **Description:** Type any description.
- **Issuing entity:** Select the PKI entity created earlier.
- **Issuing method:** SIGN
- **Templates:** Select the template added under the PKI entity.

Credential Providers: General Information

You can define one or more credential providers for device certificate issuance and lifecycle. The credential providers control the certificate format (subject, key, algorithms) and the conditions for the certificate renewal or revocation, if any.

Name*	XenMobile_PKI
Description	XenMobile PKI Configuration
Issuing entity	MS PKI
Issuing method	SIGN
Templates	XMTemplates

4. Click **Certificate Signing Request** and then enter the following parameters:

- **Key algorithm:** RSA
- **Key size:** 2048
- **Signature algorithm:** SHA1withRSA
- **Subject name:** cn=\$user.username

For **Subject Alternative Names**, click **Add** and then enter the following parameters:

- **Type:** User Principal name
- **Value:** \$user.userprincipalname

Credential Providers	Credential Providers: Certificate Signing Request						
1 General	<p>Configure the parameters for the key pair that is created during issuance, as well as the parameters of the new certificate.</p> <p>Key algorithm: RSA</p> <p>Key size*: 2048</p> <p>Signature algorithm: SHA1withRSA</p> <p>Subject name*: cn=Suser.username</p> <p>Subject alternative names</p> <table border="1"> <thead> <tr> <th>Type</th> <th>Value*</th> <th>Add</th> </tr> </thead> <tbody> <tr> <td>User Principal name</td> <td>Suser.userprincipalname</td> <td></td> </tr> </tbody> </table>	Type	Value*	Add	User Principal name	Suser.userprincipalname	
Type		Value*	Add				
User Principal name		Suser.userprincipalname					
2 Certificate Signing Request							
3 Distribution							
4 Revocation XenMobile							
5 Revocation PKI							
6 Renewal							

5. Click **Distribution** and enter the following parameters:

- **Issuing CA certificate:** Select the Issuing CA that signed the XenMobile Client Certificate.
- **Select distribution mode:** Select **Prefer centralized: Server-side key generation**.

Credential Providers	Credential Providers: Distribution
1 General	<p>Issuing CA certificate: ON-training-AD-CA, Serial: [redacted]</p> <p>Select distribution mode</p> <p><input checked="" type="radio"/> Prefer centralized: Server-side key generation</p> <p><input type="radio"/> Prefer distributed: Device-side key generation</p> <p><input type="radio"/> Only distributed: Device-side key generation</p>
2 Certificate Signing Request	
3 Distribution	
4 Revocation XenMobile	

6. For the next two sections -- **Revocation XenMobile** and **Revocation PKI** -- set the parameters as required. For the purpose of this article, both options are skipped.

7. Click **Renewal**.

8. For **Renew certificates when they expire**, select **ON**.

9. Leave all other settings as default or change them as required.

Credential Providers	Credential Providers: Renewal
1 General	<p>Renew certificates when they expire: <input checked="" type="checkbox"/> ON</p> <p>Renew when the certificate comes within*: 30 days of expiration</p> <p><input type="checkbox"/> Do not renew certificates that have already expired</p> <p>Send notification: OFF</p> <p>Notify when the certificate nears expiration: OFF</p>
2 Certificate Signing Request	
3 Distribution	
4 Revocation XenMobile	
5 Revocation PKI	
6 Renewal	

10. Click **Save**.

Configuring Secure Mail to use certificate-based authentication

When you add Secure Mail to XenMobile, be sure to configure the Exchange settings under **App Settings**.

The screenshot shows the XenMobile console interface. The top navigation bar includes 'XenMobile', 'Analyze', 'Manage', and 'Configure'. The 'Configure' tab is selected, and the 'App Settings' section is expanded. The 'App Settings' section includes the following configuration items:

- App Interaction**
 - Explicit logoff notification**: Shared devices only
- App Settings**
 - WorxMail Exchange Server**: mail.testlab.com:9443
 - WorxMail user domain**: testlab.com
 - Background network services**: mail.testlab.com:443,ap-southeast-1.pushre
 - Background services ticket expiration**: 168

Configuring NetScaler certificate delivery in XenMobile

1. Log on to the XenMobile console and click the gear icon in the upper-right corner. The **Settings** screen appears.

2. Under **Server**, click **NetScaler Gateway**.

3. If NetScaler Gateway isn't already added, click **Add** and specify the settings:

- **External URL**: <https://YourNetScalerGatewayURL>
- **Logon Type**: Certificate
- **Password Required**: OFF
- **Set as Default**: ON

4. For **Deliver user certificate for authentication**, select **On**.

XenMobile Analyze Manage Configure admin

Settings > NetScaler Gateway

NetScaler Gateway

When you configure NetScaler Gateway, you configure the authentication mechanism for remote device access to the internal network. If you use NetScaler Gateway with StoreFront as the authentication server, you need to enable StoreFront as well.

Authentication

Deliver user certificate for authentication ?

Credential provider

<input type="checkbox"/>	Name	Default	External URL	Logon Type	# of Callback URLs
--------------------------	------	---------	--------------	------------	--------------------

5. For **Credential Provider**, select a provider and then click **Save**.

6. If you will use sAMAccount attributes in the user certificates as an alternative to User Principal Name (UPN), configure the LDAP connector in XenMobile as follows: Go to **Settings > LDAP**, select the directory and click **Edit**, and select **sAMAccountName** in **User search by**.

XenMobile Analyze Manage Configure admin

User base DN*

Group base DN*

User ID*

Password*

Domain alias*

XenMobile Lockout Limit

XenMobile Lockout Time

Global Catalog TCP Port

Global Catalog Root Context

User search by

Use secure connection

Creating an Enterprise Hub policy for Windows Phone

For Windows Phone devices, you must create an Enterprise Hub device policy to deliver the AETX file and the Secure Hub client.

Note

Ensure that both the AETX and Secure Hub files were using the same enterprise certificate from the certificate provider and the same Publisher ID from the Windows Store developer account.

1. In the XenMobile console, click **Configure > Device Policies**.
2. Click **Add** and then, under **More > XenMobile Agent**, click **Enterprise Hub**.
3. After naming the policy, be sure to select the correct .AETX file and signed Secure Hub app for the Enterprise Hub.

4. Assign the policy to delivery groups and save it.

Troubleshooting your client certificate configuration

After a successful configuration of the preceding configuration plus the NetScaler Gateway configuration, the user workflow is as follows:

1. Users enroll their mobile device.
2. XenMobile prompts users to create a Citrix PIN.
3. Users are then redirected to the XenMobile Store.
4. When users start Secure Mail, XenMobile will not prompt them for user credentials in order to configure their mailbox. Instead, Secure Mail requests the client certificate from Secure Hub and submits it to Microsoft Exchange Server for authentication. If XenMobile prompts for credentials when users start Secure Mail, check your configuration.

If users can download and install Secure Mail, but during the mailbox configuration Secure Mail fails to finish the configuration:

1. If Microsoft Exchange Server ActiveSync is using private SSL server certificates to secure the traffic, verify that the Root/Intermediate certificates are installed on the mobile device.
2. Verify that the authentication type selected for ActiveSync is **Require client certificates**.

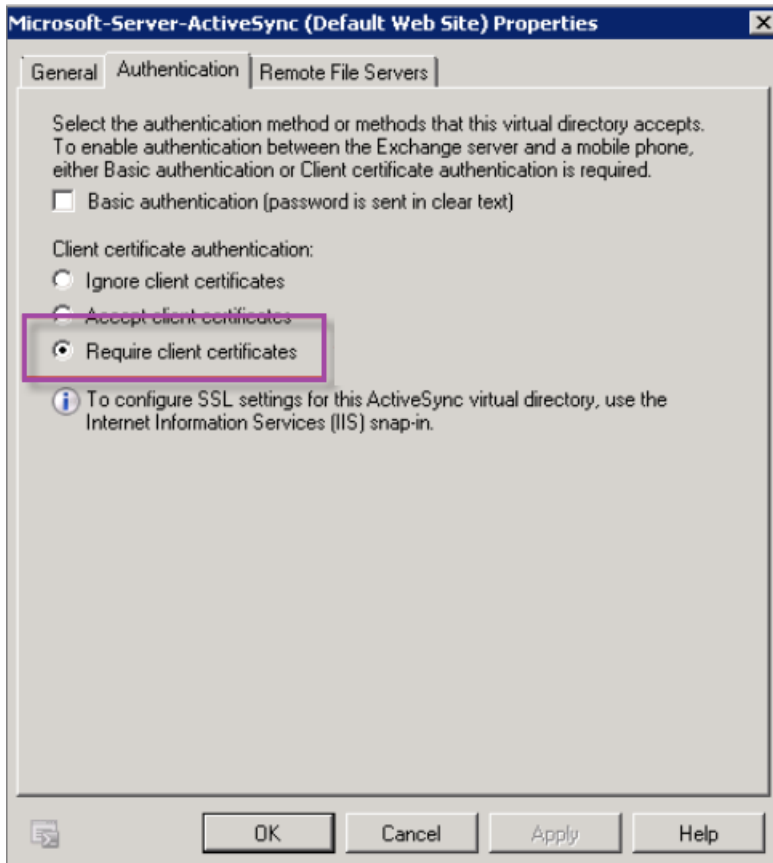

3. On Microsoft Exchange Server, check the **Microsoft-Server-ActiveSync** site to have client certificate mapping authentication enabled (by default it is disabled). The option is under **Configuration Editor > Security > Authentication**.

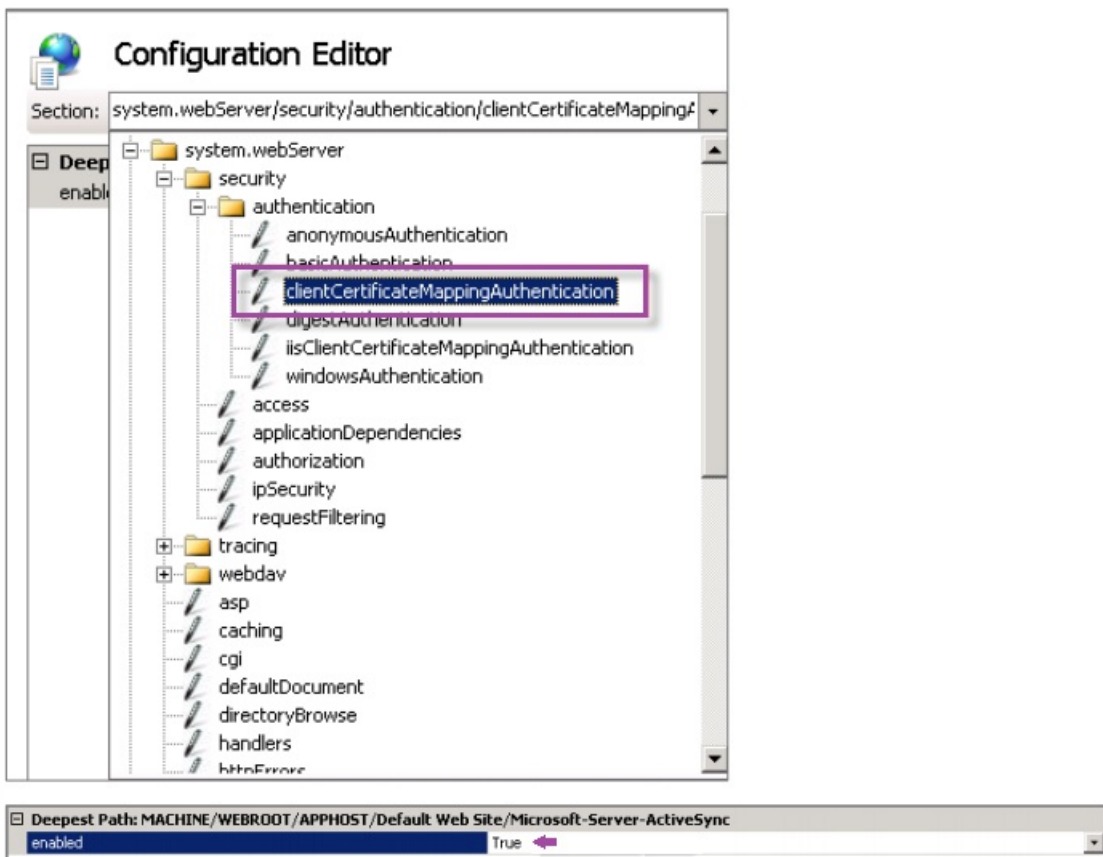

Note: After selecting **True**, be sure to click **Apply** for the changes take effect.

4. Check the NetScaler Gateway settings in the XenMobile console: Ensure that **Deliver user certificate for authentication** is **ON** and that **Credential provider** has the correct profile selected, as described earlier in "To configure NetScaler certificate delivery in XenMobile."

To determine if the client certificate was delivered to a mobile device:

1. In the XenMobile console, go to **Manage > Devices** and select the device.
2. Click **Edit** or **Show More**.
3. Go to the **Delivery Groups** section, and search for this entry:

NetScaler Gateway Credentials : Requested credential, CertId=

To validate whether client certificate negotiation is enabled:

1. Run this netsh command to show the SSL Certificate configuration that is bound on the IIS website:

```
netsh http show sslcert
```

2. If the value for **Negotiate Client Certificate** is **Disabled**, run the following command to enable it:

```
netsh http delete sslcert ipport=0.0.0.0:443
```

```
netsh http add sslcert ipport=0.0.0.0:443 certhash=cert_hash appid={app_id} certstorename=store_name  
verifyclientcertrevocation=Enable VerifyRevocationWithCachedClientCertOnly=Disable UsageCheck=Enable  
clientcertnegotiation=Enable
```

For Example:

```
netsh http add sslcert ipport=0.0.0.0:443 certhash=609da5df280d1f54a7deb714fb2c5435c94e05da appid=  
{4dc3e181-e14b-4a21-b022-59fc669b0914} certstorename=ExampleCertStoreName  
verifyclientcertrevocation=Enable VerifyRevocationWithCachedClientCertOnly=Disable UsageCheck=Enable  
clientcertnegotiation=Enable
```

If you cannot deliver Root/Intermediate certificates to a Windows Phone 8.1 device through XenMobile:

- Send Root/Intermediate certificates (.cer) files through email to the Windows Phone 8.1 device and install them directly.

If Secure Mail won't install successfully on Windows Phone 8.1:

- Verify that the Application Enrollment Token (.AETX) file is delivered through XenMobile using the Enterprise Hub device policy.
- Verify that the Application Enrollment Token was created using the same Enterprise Certificate from the certificate provider used to wrap Secure Mail and sign Secure Hub apps.
- Verify that the same Publisher ID is being used to sign and wrap Secure Hub, Secure Mail, and the Application Enrollment Token.

PKI entities

Sep 01, 2017

A XenMobile Public Key Infrastructure (PKI) entity configuration represents a component performing actual PKI operations (issuance, revocation, and status information). These components may either be internal to XenMobile, in which case they are called discretionary, or external to XenMobile if they are part of your corporate infrastructure.

XenMobile supports the following types of PKI entities:

- Generic PKIs (GPKIs)

XenMobile Server GPKI support includes Symantec Managed PKI.

- Microsoft Certificate Services
- Discretionary Certificate Authorities (CAs)

XenMobile supports the following CA servers:

- Windows Server 2008 R2
- Windows Server 2012
- Windows Server 2012 R2

Common PKI concepts

Regardless of its type, every PKI entity has a subset of the following capabilities:

- sign: Issuing a new certificate, based on a Certificate Signing Request (CSR).
- fetch: Recovering an existing certificate and key pair.
- revoke: Revoking a client certificate.

About CA certificates

When you configure a PKI entity, you must indicate to XenMobile which CA certificate is going to be the signer of certificates issued by (or recovered from) that entity. That same PKI entity may return (fetched or newly signed) certificates signed by any number of different CAs.

You must provide the certificate of each of these CAs as part of the PKI entity configuration. To do so, you upload the certificates to XenMobile and then reference them in the PKI entity. For discretionary CAs, the certificate is implicitly the signing CA certificate, but for external entities, you must specify the certificate manually.

Important

When you create a Microsoft Certificate Services Entity template, to avoid possible authentication issues with enrolled devices, avoid using special characters, such as :, !, \$, (), #, %, +, *, ~, ?, |, {}, and [] in the template name.

Generic PKI

The Generic PKI (GPKI) protocol is a proprietary XenMobile protocol running over a SOAP Web Service layer for purposes of uniform interfacing with various PKI solutions. The GPKI protocol defines the following three fundamental PKI operations:

- sign: The adapter is capable of taking CSRs, transmitting them to the PKI, and returning newly signed certificates.
- fetch: The adapter is capable of retrieving (recovering) existing certificates and key pairs (depending on input parameters) from the PKI.
- revoke: The adapter is able to cause the PKI to revoke a given certificate.

The receiving end of the GPKI protocol is the GPKI adapter. The adapter translates the fundamental operations to the specific type of PKI for which it was built. In other words, there is a GPKI adapter for RSA, another for EnTrust, and so on.

The GPKI adapter, as a SOAP Web Services endpoint, publishes a self-describing Web Services Description Language (WSDL) definition. Creating a GPKI PKI entity amounts to providing XenMobile with that WSDL definition, either through a URL or by uploading the file itself.

Support for each of the PKI operations in an adapter is optional. If an adapter supports a given operation, the adapter is said to have the corresponding capability (sign, fetch, or revoke). Each of these capabilities may be associated with a set of user parameters.

User parameters are parameters that are defined by the GPKI adapter for a specific operation and for which you need to provide values to XenMobile. XenMobile determines which operations the adapter supports (which capabilities it has) and which parameters the adapter requires for each of the operations by parsing the WSDL file. If you choose, use SSL client authentication to secure the connection between XenMobile and the GPKI adapter.

Add a generic PKI

1. In the XenMobile console, click **Settings > PKI Entities**.
2. On the **PKI Entities** page, click **Add**.

A menu of PKI entity types appears.

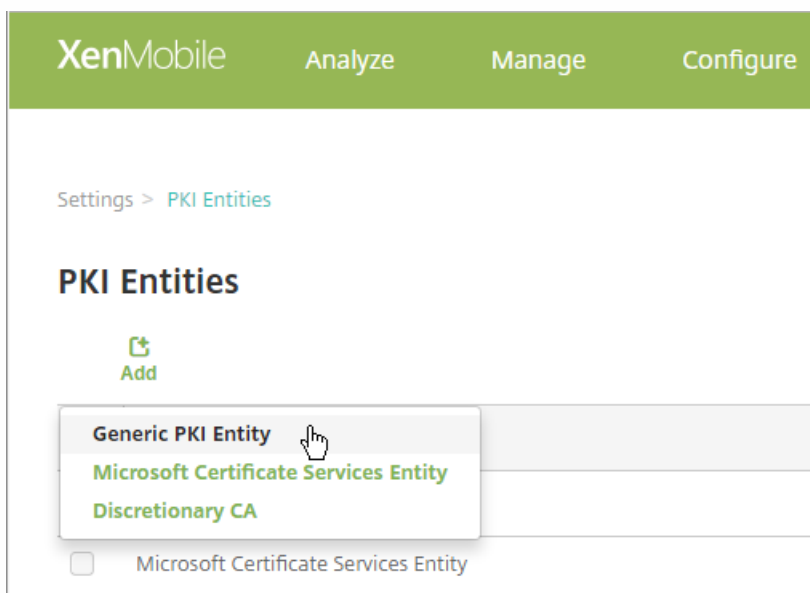

3. Click **Generic PKI Entity**.

The Generic PKI Entity: General Information page appears.

4. On the **Generic PKI Entity: General Information** page, do the following:

- **Name:** Type a descriptive name for the PKI entity.
- **WSDL URL:** Type the location of the WSDL describing the adapter.
- **Authentication type:** Click the authentication method you want to use.
- **None**
- **HTTP Basic:** Provide the user name and password needed to connect to the adapter.
- **Client certificate:** Select the correct SSL client certificate.

5. Click **Next**.

The Generic PKI Entity: Adapter Capabilities page appears.

6. On the **Generic PKI Entity: Adapter Capabilities** page, review the capabilities and parameters associated with your adapter and then click **Next**.

The **Generic PKI Entity: Issuing CA Certificates** page appears.

7. On the Generic PKI Entity: Issuing CA Certificates page, select the certificates you want to use for the entity.

Note: Although entities may return certificates signed by different CAs, all certificates obtained through a given certificate provider must be signed by the same CA. Accordingly, when configuring the **Credential Provider** setting, on the **Distribution** page, select one of the certificates configured here.

8. Click **Save**.

The entity appears on the PKI Entities table.

Symantec Managed PKI

XenMobile Server GPKI support includes Symantec Managed PKI. This section describes how to set up Windows Server and XenMobile Server for Symantec Managed PKI.

Prerequisites

- Access to Symantec Managed PKI Infrastructure
- Windows Server 2012 R2 server with the following components installed:
 - Java
 - Apache Tomcat
 - Symantec PKI Client
 - Portecle

For information about installing those components, see "Set up Windows Server," next.

- Access to the XenMobile downloads site

Set up Windows Server

This section assists you in setting up Windows Server so that it meets the XenMobile requirements for GPKI support.

Install Java on Windows Server

Download Java from https://java.com/en/download/faq/java_win64bit.xml and then install it. In the Security Warning dialog box, be sure to click **Run**.

Install Apache Tomcat on Windows Server

Download the Apache Tomcat 32-bit/64-bit Windows Service Installer from <https://tomcat.apache.org/download-80.cgi> and then install it. In the Security Warning dialog box, be sure to click **Run**. Complete the Apache Tomcat setup, using the following examples as a guide.

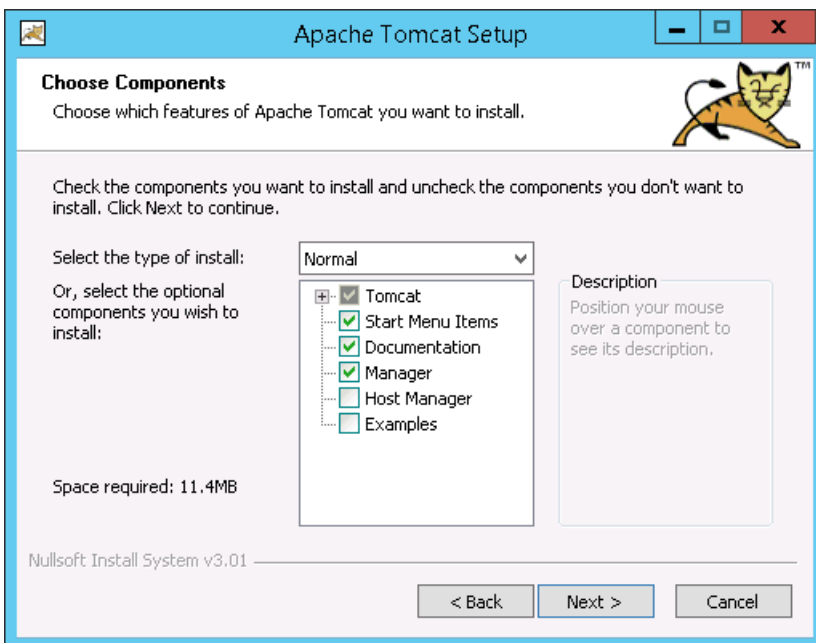

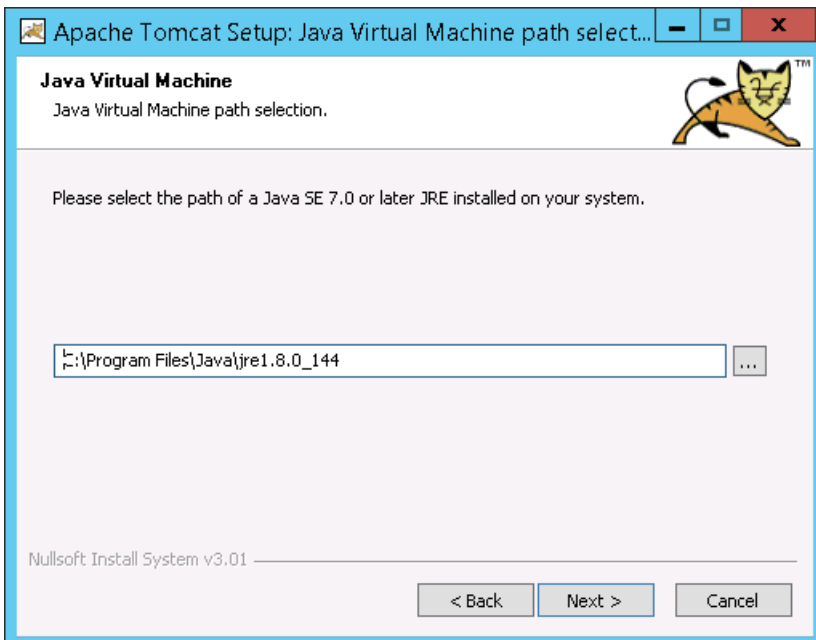
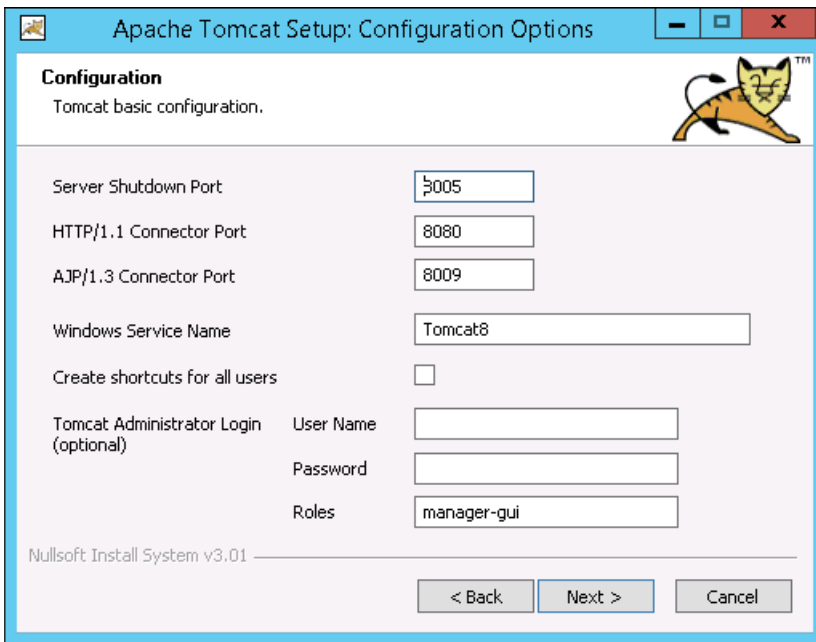

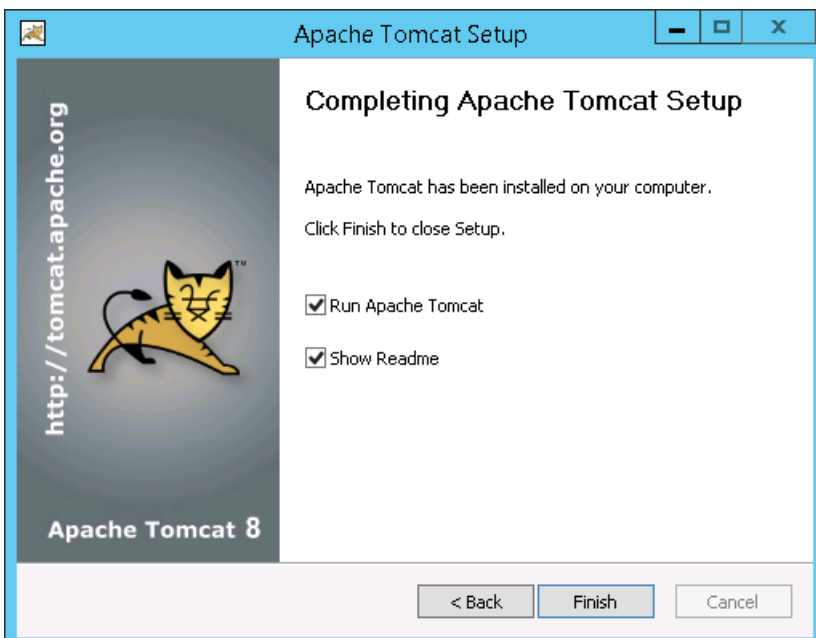
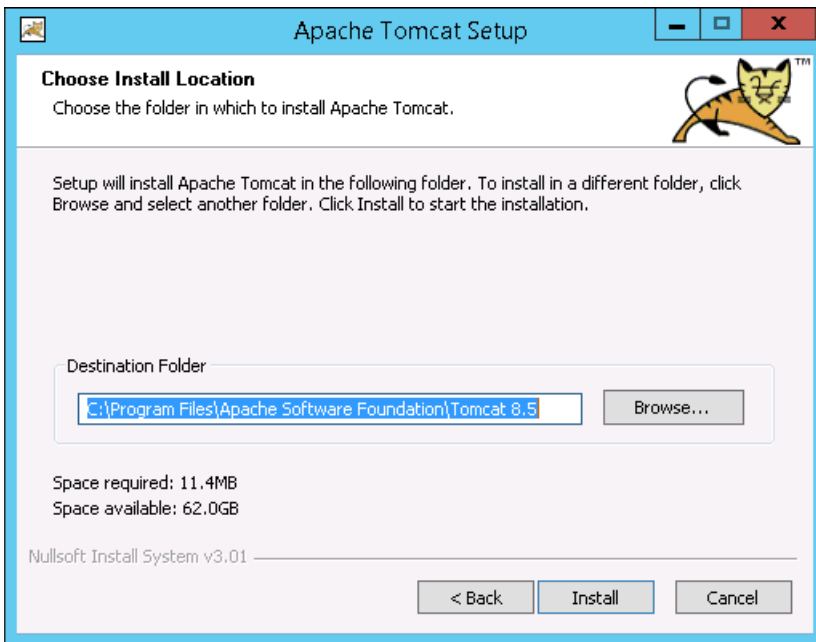

Next, go to Windows Services and change **Startup Type** from **Manual** to **Automatic**.

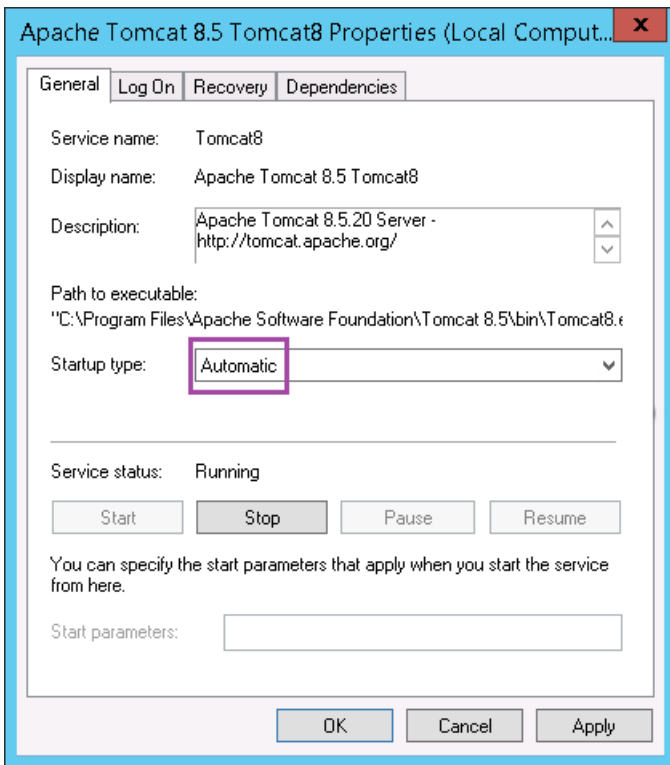
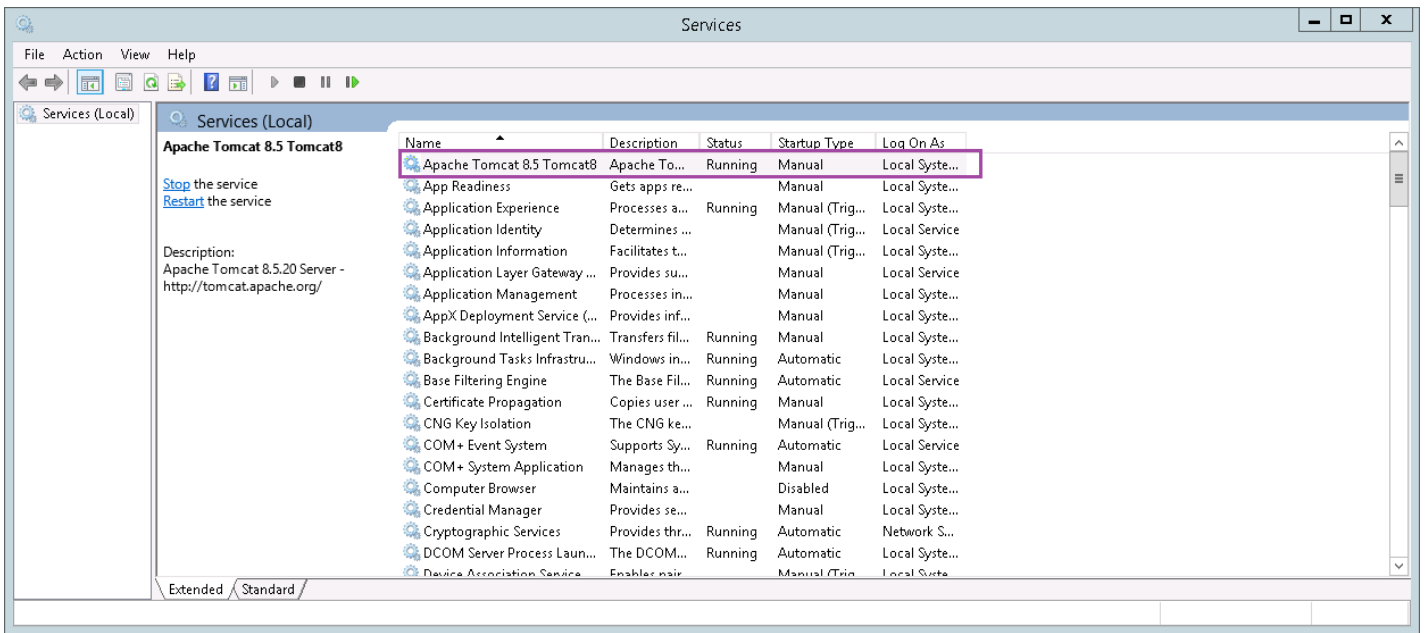

Install Symantec PKI Client on Windows Server

Download the installer from the PKI Manager console. If you don't have access to that console, download the installer from the Symantec support page, [How to download Symantec PKI Client](#). Unzip and run the installer.

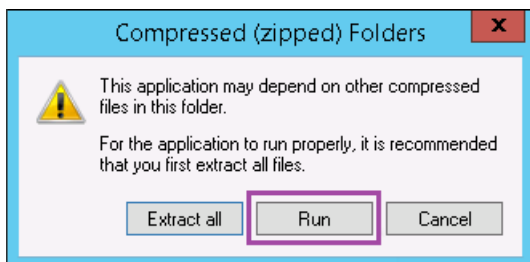
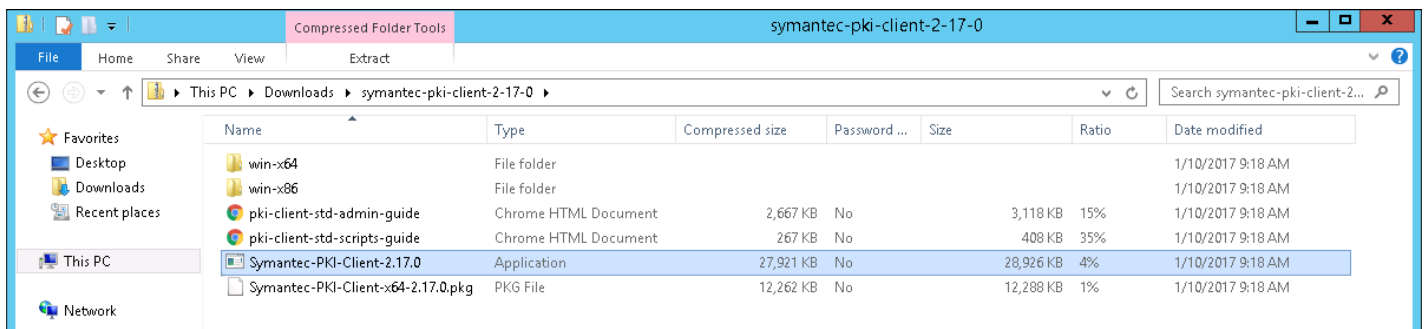

In the Security Warning dialog box, be sure to click **Run**. Follow the instructions in the installer to complete the setup. When the installer completes, it prompts you to restart.

Install Portecle on Windows Server

Download the installer from <https://sourceforge.net/projects/portecle/>, and then unzip and run the installer.

Configure Symantec PKI Adapter on Windows Server

1. Log in to Windows Server as an administrator.
2. Download the Symantec folder from [XenMobile download](#). Copy the Symantec folder under the Windows Server C: drive.

The Symantec folder contains the following files:

- cacerts.jks
- custom_gpki_adapter.properties
- RA.jks
- Symantec.war

3. Replace RA.jks and cacerts.jks with the correct RA and CA certificate key stores.
4. Open custom_gpki_adapter.properties in Notepad and edit the following values:

```
Gpki.CaSvc.Url=https://<managed PKI URL>
```

```
# keystore for client-cert auth
```

```
keyStore=C:\\Symantec\\RA.jks
```

```
# truststore for server with self-signed root CA
```

```
trustStore=C:\\Symantec\\cacerts.jks
```

- Copy Symantec.war under the folder <tomcat dir>\webapps and then start Tomcat.
- Verify that the application deployed: Open a web browser and navigate to <http://localhost/Symantec>.
- Navigate to the folder <tomcat dir>\webapps\Symantec\WEB-INF\classes and edit the gpk_adapter.properties. Modify the property CustomProperties to point it to the custom_gpk_adapter file under the C:\Symantec folder:

CustomProperties=C:\\Symantec\\custom_gpk_adapter.properties
- Restart Tomcat, navigate to <http://localhost/Symantec>, and then copy the endpoint address. In the next section, you paste that address when configuring the PKI adapter.

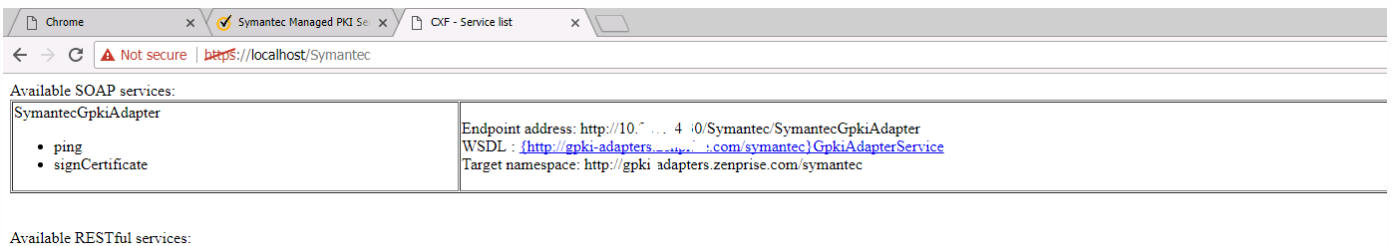

Configure XenMobile Server for Symantec Managed PKI

Complete the Windows Server setup before performing the following XenMobile Server configuration.

To import the Symantec CA certificates and configure the PKI Entity

- Import the Symantec CA certificates that issue the end-user certificate: In the XenMobile Server console, go to **Settings > Certificates** and click **Import**.

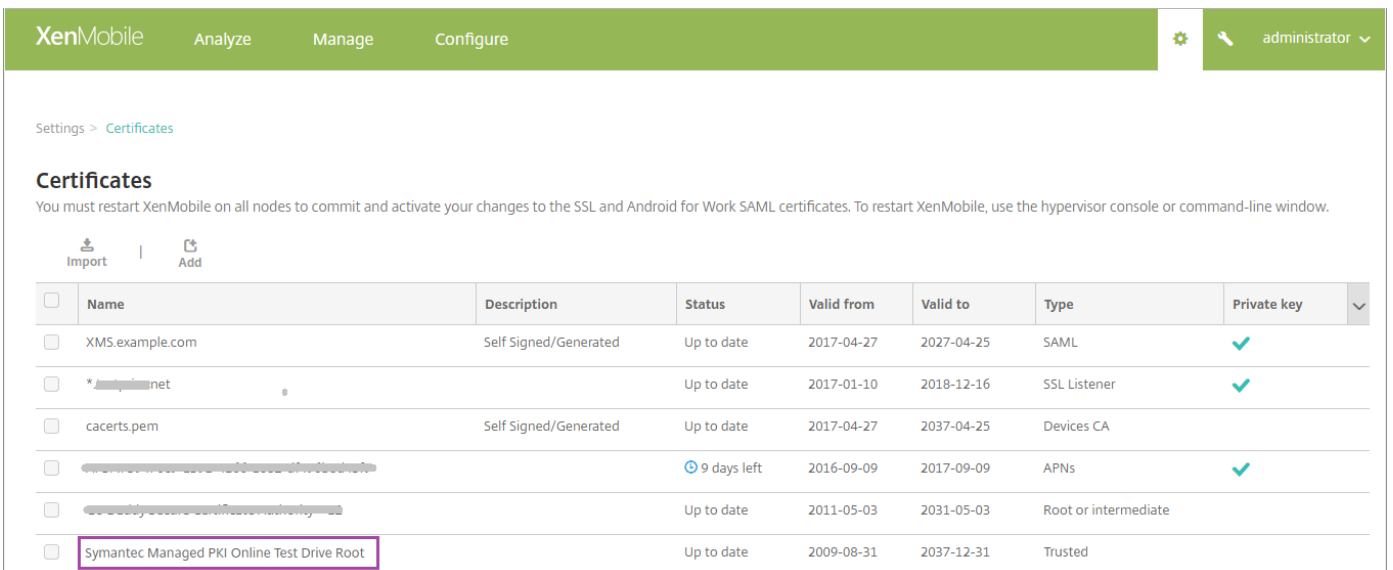

- Add and configure the PKI Entity: Go to **Settings > PKI Entities**, click **Add**, and then choose **Generic PKI Entity**. In

WSDL URL, paste the endpoint address that you copied when configuring the PKI adapter in the previous section, and then append **?wsdl** as shown below.

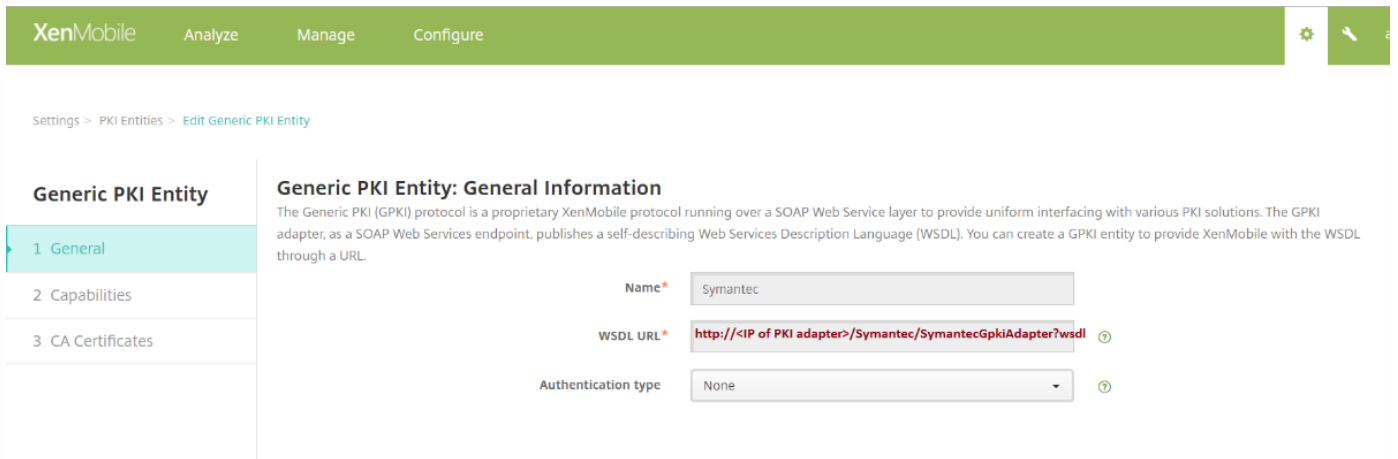

3. Click **Next**. XenMobile populates the parameter names from the WSDL.

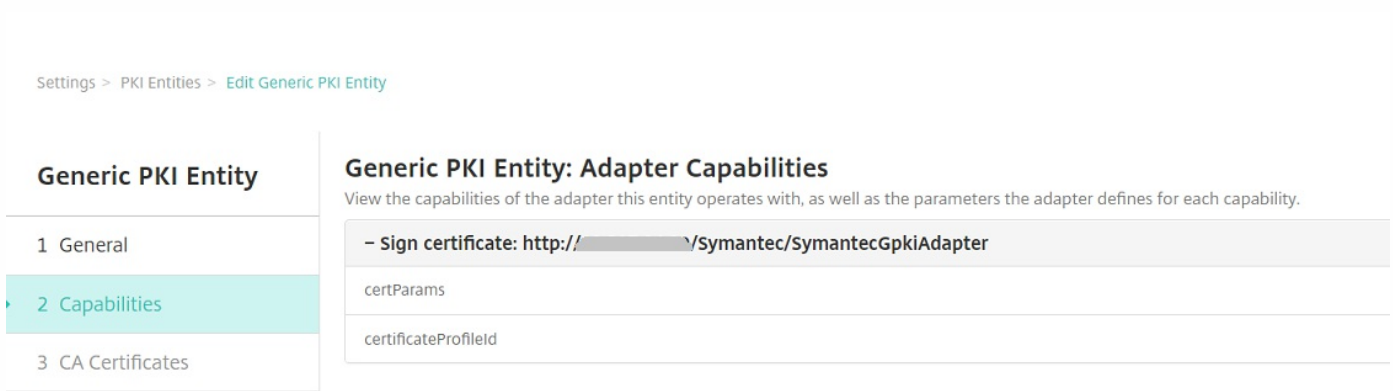

4. Click **Next**, select the correct CA certificate, and then click **Save**.

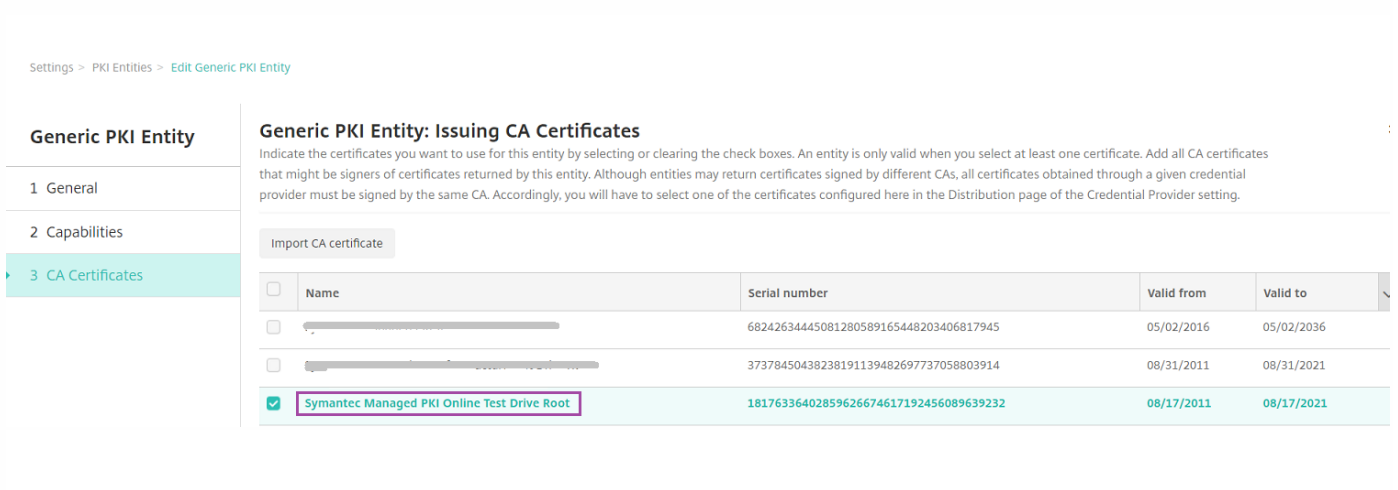

5. On the **Settings > PKI Entities** page, verify that the PKI Entity you added has a **State** of **Valid**.

Settings > PKI Entities

PKI Entities

⊕ Add

<input type="checkbox"/>	Name	Type	Capabilities	Description	State
<input type="checkbox"/>	Symantec	GPKI	SIGN	http://[redacted]/Symantec/SymantecGpkiAdapter	Valid

To create the credential provider for Symantec Managed PKI

1. In the Symantec PKI Manager console, copy the **Certificate Profile OID** from the Certificate Template.

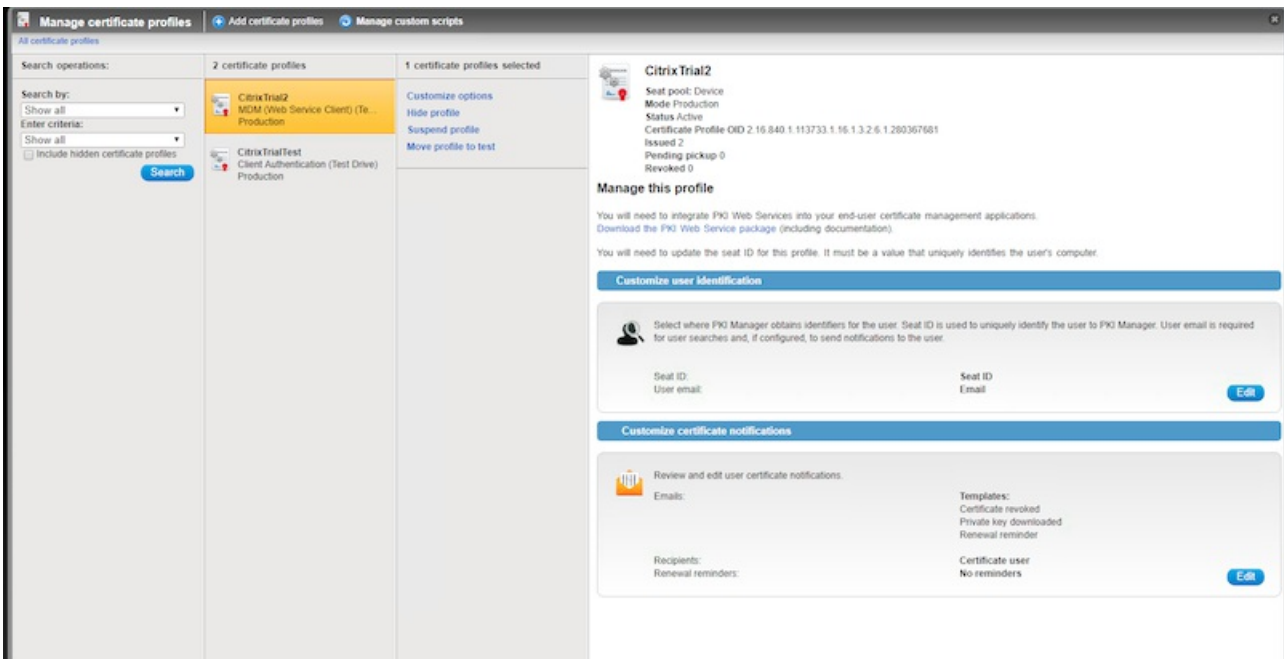

2. In the XenMobile Server console, go to **Settings > Credential Providers**, click **Add**, and then configure the settings as follows.

- **Name:**Type a unique name for the new provider configuration. This name is used to refer to the configuration in other parts of the XenMobile console.
- **Description:** Describe the credential provider. Although this is an optional field, a description can be useful when you need details about this credential provider.
- **Issuing entity:** Choose the certificate issuing entity.
- **Issuing method:** Choose **Sign** as the method that the system uses to obtain client certificates from the configured entity.
- **certParams:** Add the following value:
commonName=\${user.mail},otherNameUPN=\${user.userprincipalname},mail=\${user.mail}
- **certificateProfileid:** Paste the Certificate Profile OID that you copied in Step 1.

Credential Providers

- 1 General
- 2 Certificate Signing Request
- 3 Distribution
- 4 Revocation XenMobile
- 5 Revocation PKI
- 6 Renewal

Credential Providers: General Information

You can define one or more credential providers for device certificate issuance and lifecycle. The credential providers control the certificate format (subject, key, algorithms) and the conditions for the certificate renewal or revocation, if any.

Name*

Description

Issuing entity

Issuing method

Parameters

Name	Value	
certParams	commonName=\${user.mail}, otherNameUPN=\${user.userprincipalname}, mail=\${user.mail}	Save Cancel
certificateProfileId	2.16.840.1.113733.1.16.1.3.2.6.1.250531744	

3. Click **Next**. On each of the remaining pages (Certificate Signing Request through Renewal), accept the default settings. When you are finished, click **Save**.

To test and troubleshoot the configuration

1. Create a Credentials device policy: Go to **Configure > Device Policies**, click **Add**, start typing **Credentials** and then click **Credentials**.
2. Specify a **Policy Name**.
3. Configure the platform settings as follows:
 - **Credential type**: Choose **Credential Provider**.
 - **Credential provider**: Choose the Symantec provider.

Device Policies Apps Actions ShareFile Enrollment Profiles Delivery Groups

Credentials Policy

- 1 Policy Info
- 2 Platforms
- iOS
- Mac OS X
- Android
- Android for Work
- Windows Phone
- Windows Desktop/Tablet

Credentials Policy

This policy lets you deliver certificates to devices. On iOS, the certificates, such as a certificate for WiFi authentication, can also be used as part of another policy. For Windows Phone, the policy is supported only on Windows 10 and later supervised devices.

Credential type

Credential provider*

Remove policy Select date Duration until removal (in hours)

Allow user to remove policy

4. After you complete the platform settings, continue to the **Assignment** page, assign the policy to delivery groups, and click **Save**.
5. To check whether the policy deployed to the device, go to **Manage > Devices**, select the device, click **Edit**, and click **Assigned Policies**. The following example shows a successful policy deployment.

XenMobile Analyze Manage Configure administrator

Devices Users Enrollment Invitations

Device details

rd@xmtest.net | iPad

- 1 General
- 2 Properties
- 3 User Properties
- 4 Assigned Policies**
- 5 Apps
- 6 Media
- 7 Actions
- 8 Delivery Groups
- 9 iOS Profiles
- 10 iOS Provisioning Profiles
- 11 Certificates
- 12 Connections
- 13 MDM Status

Assigned Policies

Deployed (1) Pending (0) Failed (0)

Name	Type	Last deployed
SymantecCredentials	Credentials	18/08/2017 15:54:13

Showing 1 - 1 of 1 items

Back Next >

If the policy didn't deploy, log in to the Windows Server and check if the WSDL is loading properly.

This XML file does not appear to have any style information associated with it. The document tree is shown below:

```

<?xml:stylesheet type="text/css" href="http://schemas.zdm.zenprise.com/gpki/" xsl:base="http://schemas.zdm.zenprise.com/gpki/sample" xsl:extension="http://schemas.xmlsoap.org/soap/http" xsl:use="http://schemas.xmlsoap.org/wsdl/soap/" xsl:version="1.0" interfaceVersion="1.0" />
<wsdl:definitions xmlns:ns1="http://schemas.zdm.zenprise.com/gpki/" xmlns:ns2="http://zdm.zenprise.com/gpki/sample" xmlns:ns3="http://schemas.xmlsoap.org/soap/http" xmlns:ns4="http://schemas.xmlsoap.org/wsdl/soap/" xmlns:ns5="http://gpki-adapters.zenprise.com/symantec">
  <wsdl:documentation>
    <adapterVersion xmlns="http://schemas.zdm.zenprise.com/gpki/" my_version="adapterVersion"><interfaceVersion xmlns="http://schemas.zdm.zenprise.com/gpki/">1.0</interfaceVersion>
  </wsdl:documentation>
  <wsdl:types>
    <xs:schema xmlns:xs="http://www.w3.org/2001/XMLSchema" elementFormDefault="qualified" targetNamespace="http://schemas.zdm.zenprise.com/gpki/">
      <xs:annotation base="targetAdapterVersion">
        <xs:documentation>
          The parameter value will be set to the adapter version string read from the WSDL at configuration-time.
        </xs:documentation>
        <xs:restriction base="xs:string"/>
      </xs:annotation>
      <xs:simpleType name="userCertificate">
        <xs:annotation base="userCertificate">
          <xs:documentation>
            The parameter value will be set to a certificate, depending on the context. - In the revokeCert method, this will be the certificate to revoke.
          </xs:documentation>
          <xs:restriction base="xs:base64Binary"/>
        </xs:annotation>
      </xs:simpleType>
      <xs:simpleType name="csr">
        <xs:annotation base="csr">
          <xs:documentation>
            The parameter value will be set to the CSR blob. This parameter type is not allowed in any "part" element but those in messages used for the signCert operation.
          </xs:documentation>
          <xs:restriction base="xs:base64Binary"/>
        </xs:annotation>
      </xs:simpleType>
      <xs:simpleType name="p12Password">
        <xs:annotation base="p12Password">
          <xs:documentation>
            The parameter value will be set to a random sequence of characters. If this parameter is present and the operation that is called returns a PKCS12 blob, the caller will assume the returned blob has been encrypted with this parameter's value.
          </xs:documentation>
          <xs:restriction base="xs:string"/>
        </xs:annotation>
      </xs:simpleType>
      <xs:element name="interfaceVersion" type="xs:string">
        <xs:annotation base="interfaceVersion">
          <xs:documentation>
            The version of the interface definition the adapter represented by this WSDL is coded against.
          </xs:documentation>
        </xs:annotation>
      </xs:element>
      <xs:element name="adapterVersion" type="xs:string">
        <xs:annotation base="adapterVersion">
          <xs:documentation>
            An arbitrary string at the adapter's discretion. Read at configuration time, stored and optionally transmitted as an injected parameter (targetAdapterVersion) at request-time. Used to ensure the definition read (WSDL) matches the service that ends up being invoked.
          </xs:documentation>
        </xs:annotation>
      </xs:element>
      <xs:element name="parameterDoc">
        <xs:annotation base="parameterDoc">
          <xs:documentation>
            An arbitrary string at the adapter's discretion. Read at configuration time, stored and optionally transmitted as an injected parameter (targetAdapterVersion) at request-time. Used to ensure the definition read (WSDL) matches the service that ends up being invoked.
          </xs:documentation>
        </xs:annotation>
      </xs:element>
    </xs:schema>
  </wsdl:types>
  <wsdl:binding name="GpkiAdapterService" type="ns1:GpkiAdapterService" targetNamespace="http://gpki-adapters.zenprise.com/symantec">
    <wsdl:operation name="signCert" type="ns1:signCert" targetNamespace="http://gpki-adapters.zenprise.com/symantec">
      <wsdl:input name="signCertRequest" type="ns1:signCertRequest" targetNamespace="http://gpki-adapters.zenprise.com/symantec">
        <xs:sequence maxOccurs="unbounded" minOccurs="0">
          <xs:any processContents="skip"/>
        </xs:sequence>
        <xs:attribute name="lang" type="xs:string" use="optional"/>
      </xs:sequence>
    </wsdl:input>
    <wsdl:output name="signCertResponse" type="ns1:signCertResponse" targetNamespace="http://gpki-adapters.zenprise.com/symantec">
      <xs:sequence maxOccurs="unbounded" minOccurs="0">
          <xs:any processContents="skip"/>
        </xs:sequence>
        <xs:attribute name="lang" type="xs:string" use="optional"/>
      </xs:sequence>
    </wsdl:output>
  </wsdl:binding>
  <wsdl:service name="GpkiAdapterService" targetNamespace="http://gpki-adapters.zenprise.com/symantec">
    <wsdl:binding value="GpkiAdapterService" type="GpkiAdapterService" targetNamespace="http://gpki-adapters.zenprise.com/symantec">
      <wsdl:operation name="signCert" type="ns1:signCert" targetNamespace="http://gpki-adapters.zenprise.com/symantec">
        <wsdl:input name="signCertRequest" type="ns1:signCertRequest" targetNamespace="http://gpki-adapters.zenprise.com/symantec">
          <xs:sequence maxOccurs="unbounded" minOccurs="0">
            <xs:any processContents="skip"/>
          </xs:sequence>
          <xs:attribute name="lang" type="xs:string" use="optional"/>
        </wsdl:input>
        <wsdl:output name="signCertResponse" type="ns1:signCertResponse" targetNamespace="http://gpki-adapters.zenprise.com/symantec">
          <xs:sequence maxOccurs="unbounded" minOccurs="0">
            <xs:any processContents="skip"/>
          </xs:sequence>
          <xs:attribute name="lang" type="xs:string" use="optional"/>
        </wsdl:output>
      </wsdl:binding>
    </wsdl:service>
  </wsdl:definitions>

```

For additional troubleshooting information, check the Tomcat logs in <tomcat dir>\logs\catalina.<current date>.

Microsoft Certificate Services

XenMobile interfaces with Microsoft Certificate Services through its web enrollment interface. XenMobile only supports the issuing of new certificates through that interface (the equivalent of the GPKI sign capability).

To create a Microsoft CA PKI entity in XenMobile, you must specify the base URL of the Certificate Services web interface. If you choose, use SSL client authentication to secure the connection between XenMobile and the Certificate Services web interface.

Add a Microsoft Certificate Services entity

1. In the XenMobile console, click the gear icon in the upper-right corner of the console and then click **PKI Entities**.
2. On the **PKI Entities** page, click **Add**.

A menu of PKI entity types appears.

3. Click **Microsoft Certificate Services Entity**.

The **Microsoft Certificate Services Entity: General Information** page appears.

4. On the **Microsoft Certificate Services Entity: General Information** page, configure these settings:

- **Name:** Type a name for your new entity, which you will use later to refer to that entity. Entity names must be unique.
- **Web enrollment service root URL:** Type the base URL of your Microsoft CA web enrollment service; for example, `https://192.0.2.13/certsrv/`. The URL may use plain HTTP or HTTP-over-SSL.
- **certnew.cer page name:** The name of the certnew.cer page. Use the default name unless you have renamed it for some reason.
- **certfnsh.asp:** The name of the certfnsh.asp page. Use the default name unless you have renamed it for some reason.
- **Authentication type:** Choose the authentication method you want to use.
 - **None**
 - **HTTP Basic:** Type the user name and password needed to connect.
 - **Client certificate:** Choose the correct SSL client certificate.

5. Click **Test Connection** to ensure that the server is accessible. If it is not accessible, a message appears, stating that the connection failed. Check your configuration settings.

6. Click **Next**.

The **Microsoft Certificate Services Entity: Templates** page appears. On this page, you specify the internal names of the templates your Microsoft CA supports. When creating credential providers, you select a template from the list defined here. Every credential provider using this entity uses exactly one such template.

For Microsoft Certificate Services templates requirements, refer to the Microsoft documentation for your Microsoft Server version. XenMobile doesn't have requirements for the certificates it distributes other than the certificate formats noted in [Certificates](#).

7. On the **Microsoft Certificate Services Entity: Templates** page, click **Add**, type the name of the template and then click **Save**. Repeat this step for each template you want to add.

8. Click **Next**.

The **Microsoft Certificate Services Entity: HTTP parameters** page appears. On this page, you specify custom parameters that XenMobile should inject in the HTTP request to the Microsoft Web Enrollment interface. This will only be useful if you have customized scripts running on the CA.

9. On the **Microsoft Certificate Services Entity: HTTP parameters** page, click **Add**, type the name and value of the HTTP parameters you want to add and then click **Next**.

The **Microsoft Certificate Services Entity: CA Certificates** page appears. On this page, you are required to inform XenMobile of the signers of the certificates that the system will obtain through this entity. When your CA certificate is renewed, update it in XenMobile and then the change is applied to the entity transparently.

10. On the **Microsoft Certificate Services Entity: CA Certificates** page, select the certificates you want to use for this entity.

11. Click **Save**.

The entity appears on the PKI Entities table.

NetScaler Certificate Revocation List (CRL)

XenMobile supports Certificate Revocation List (CRL) only for a third-party Certificate Authority. If you have a Microsoft CA configured, XenMobile uses NetScaler to manage revocation.

When you configure client certificate-based authentication, consider whether you need to configure the NetScaler Certificate Revocation List (CRL) setting, **Enable CRL Auto Refresh**. This step ensures that the user of a device in MAM-only mode can't authenticate using an existing certificate on the device; XenMobile re-issues a new certificate, because it doesn't restrict a user from generating a user certificate if one is revoked. This setting increases the security of PKI entities when the CRL checks for expired PKI entities.

Discretionary CAs

A discretionary CA is created when you provide XenMobile with a CA certificate and the associated private key. XenMobile handles certificate issuance, revocation, and status information internally, according to the parameters you specify.

When configuring a discretionary CA, you have the option to activate Online Certificate Status Protocol (OCSP) support for that CA. If, and only if you enable OCSP support, the CA adds an id-pe-authorityInfoAccess extension to the certificates that the CA issues, pointing to the XenMobile internal OCSP Responder at the following location.

`https://server/instance/ocsp`

When configuring the OCSP service, you must specify an OCSP signing certificate for the discretionary entity in question. You can use the CA certificate itself as the signer. If you want to avoid the unnecessary exposure of your CA private key (recommended), create a delegate OCSP signing certificate, signed by the CA certificate and include an id-kp-OCSPSigning extendedKeyUsage extension.

The XenMobile OCSP responder service supports basic OCSP responses and the following hashing algorithms in requests:

- SHA-1
- SHA-224
- SHA-256
- SHA-384
- SHA-512

Responses are signed with SHA-256 and the signing certificate key algorithm (DSA, RSA or ECDSA).

Add discretionary CAs

1. In the XenMobile console, click the gear icon in the upper-right corner of the console and then click **More > PKI Entities**.
2. On the **PKI Entities** page, click **Add**.

A menu of PKI entity types appears.

3. Click **Discretionary CA**.

The **Discretionary CA: General Information** page appears.

4. On the **Discretionary CA: General Information** page, do the following:
 - **Name:** Type a descriptive name for the discretionary CA.
 - **CA certificate to sign certificate requests:** Click a certificate for the discretionary CA to use to sign certificate requests. This list of certificates is generated from the CA certificates with private keys you uploaded at XenMobile at **Configure > Settings > Certificates**.
5. Click **Next**.

The **Discretionary CA: Parameters** page appears.

6. On the **Discretionary CA: Parameters** page, do the following:
 - **Serial number generator:** The discretionary CA generates serial numbers for the certificates it issues. From this list, click **Sequential** or **Non-sequential** to determine how the numbers are generated.
 - **Next serial number:** Type a value to determine the next number issued.
 - **Certificate valid for:** Type the number of days the certificate is valid.
 - **Key usage:** Identify the purpose of the certificates issued by the discretionary CA by setting the appropriate keys to **On**. Once set, the CA is limited issuing certificates for those purposes.
 - **Extended key usage:** To add additional parameters, click **Add**, type the key name and then click **Save**.
7. Click **Next**.

The **Discretionary CA: Distribution** page appears.

8. On the **Discretionary CA: Distribution** page, select a distribution mode:
 - **Centralized: server-side key generation.** Citrix recommends the centralized option. The private keys are generated and stored on the server and distributed to user devices.
 - **Distributed: device-side key generation.** The private keys are generated on the user devices. This distributed mode uses SCEP and requires an RA encryption certificate with the keyUsage keyEncryption and an RA signing certificate with the KeyUsage digitalSignature. The same certificate can be used for both encryption and signing.
9. Click **Next**.

The **Discretionary CA: Online Certificate Status Protocol (OCSP)** page appears.

On the **Discretionary CA: Online Certificate Status Protocol (OCSP)** page, do the following:

- If you want to add an AuthorityInfoAccess (RFC2459) extension to the certificates signed by this CA, set **Enable OCSP support for this CA** to **On**. This extension points to the CA's OCSP responder at <https://server/instance/ocsp>.
- If you enabled OCSP support, select an OCSP signing CA certificate. This list of certificates is generated from the CA certificates you uploaded to XenMobile.

10. Click **Save**.

The discretionary CA appears on the PKI Entities table.

Credential providers

Sep 01, 2017

Credential providers are the actual certificate configurations you use in the various parts of the XenMobile system. They define the sources, parameters, and life cycles of your certificates, whether the certificates are part of device configurations or are standalone - that is, pushed as is to the device.

Device enrollment constrains the certificate life cycle. That is, XenMobile does not issue certificates before enrollment, although XenMobile may issue some certificates as part of enrollment. In addition, certificates issued from the internal PKI within the context of one enrollment are revoked when the enrollment is revoked. After the management relationship terminates, no valid certificate remains.

You may use one credential provider configuration in multiple places, to the effect that one configuration may govern any number of certificates at the same time. The unity, then, is on the deployment resource and the deployment. For example, if Credential Provider P is deployed to device D as part of configuration C, then the issuance settings for P determine the certificate that is deployed to D. Likewise, the renewal settings for D apply when C is updated, and the revocation settings for D also apply when C is deleted or when D is revoked.

With this in mind, the credential provider configuration in XenMobile does the following:

- Determines the source of certificates.
- Determines the method in which certificates are obtained: Signing a new certificate or fetching (recovering) an existing certificate and key pair.
- Determines the parameters for issuance or recovery. For example, Certificate Signing Request (CSR) parameters, such as key size, key algorithm, distinguished name, certificate extensions, and so on.
- Determines the manner in which certificates are delivered to the device.
- Determines revocation conditions. Although all certificates are revoked in XenMobile when the management relationship is severed, the configuration may specify an earlier revocation; for instance, when the associated device configuration is deleted. In addition, under some conditions, the revocation of the associated certificate in XenMobile may be sent to the back-end public key infrastructure (PKI); that is, its revocation in XenMobile may cause its revocation on the PKI.
- Determines renewal settings. Certificates obtained through a given credential provider may be automatically renewed when they near expiration, or, separately from that situation, notifications may be issued when that expiration approaches.

To what extent various configuration options are available mainly depends on the type of PKI Entity and issuance method that you select for a credential provider.

Methods of certificate issuance

You can obtain a certificate, which is referred to as methods of issuance in two ways:

- **sign.** With this method, the issuance involves creating a new private key, creating a CSR, and submitting the CSR to a Certificate Authority (CA) for signature. XenMobile supports the sign method for the three PKI entities (MS Certificate Services Entity, Generic PKI and Discretionary CA).
- **fetch.** With this method, the issuance, for the purposes of XenMobile, is a recovery of an existing key pair. XenMobile supports the fetch method only for Generic PKI.

A credential provider uses either the sign or fetch method of issuance. The selected method affects the available configuration options. Notably, CSR configuration and distributed delivery are available only if the issuing method is sign. A

fetches certificate is always sent to the device as a PKCS#12, the equivalent of centralized delivery mode for the sign method.

Certificate Delivery

Two modes of certificate delivery are available in XenMobile: centralized and distributed. Distributed mode uses Simple Certificate Enrollment Protocol (SCEP) and is only available in situations in which the client supports the protocol (iOS only). Distributed mode is mandatory in some situations.

For a credential provider to support distributed (SCEP-assisted) delivery, a special configuration step is necessary: Setting up Registration Authority (RA) certificates. The RA certificates are required, because, if you use the SCEP protocol, XenMobile acts like a delegate (a registrar) to the actual certificate authority. XenMobile must prove to the client that it has the authority to act as such. That authority is established by uploading the previously mentioned certificates to XenMobile.

Two distinct certificate roles are required (although a single certificate can fulfill both requirements): RA signature and RA encryption. The constraints for these roles are as follows:

- The RA signing certificate must have the X.509 key usage digital signature.
- The RA encryption certificate must have the X.509 key usage key encipherment.

To configure the credential provider RA certificates, you must upload the certificates to XenMobile and then link to them in the credential provider.

A credential provider is considered to support distributed delivery only if the provider has a certificate configured for certificate roles. You can configure each credential provider to either prefer centralized mode, to prefer distributed mode, or to require distributed mode. The actual result depends on the context: If the context does not support distributed mode, but the credential provider requires this mode, deployment fails. Likewise, if the context mandates distributed mode, but the credential provider does not support distributed mode, deployment fails. In all other cases, the preferred setting is honored.

The following table shows SCEP distribution throughout XenMobile:

Context	SCEP supported	SCEP required
iOS Profile Service	Yes	Yes
iOS mobile device management enrollment	Yes	No
iOS configuration profiles	Yes	No
SHTTP enrollment	No	No
SHTTP configuration	No	No
Windows Phone and Tablet enrollment	No	No

Windows Phone and Tablet configuration	SCEP supported for the Wifi device policy, which is supported for Windows Phone 8.1 and the latest Windows 10 release	SCEP required
--	---	---------------

Certificate Revocation

There are three types of revocation.

- **Internal revocation.** Internal revocation affects the certificate status as maintained by XenMobile. This status is taken into account when XenMobile evaluates a certificate presented to it, or when XenMobile has to provide OCSP status information for some certificate. The credential provider configuration determines how this status is affected under various conditions. For instance, the credential provider may specify that certificates obtained through the certificate provider should be flagged as revoked when the certificates have been deleted from the device.
- **Externally propagated revocation.** Also known as Revocation XenMobile, this type of revocation applies to certificates obtained from an external PKI. The certificate is revoked on the PKI when the certificate is internally revoked by XenMobile, under the conditions defined by the credential provider configuration. The call to perform the revocation requires a revoke-capable General PKI (GPKI) entity.
- **Externally induced revocation.** Also known as Revocation PKI, this type of revocation also only applies to certificates obtained from an external PKI. Whenever XenMobile evaluates a given certificate status, XenMobile queries the PKI as to that status. If the certificate is revoked, XenMobile internally revokes the certificate. This mechanism uses the OCSP protocol.

These three types are not exclusive, but rather apply together: The internal revocation is caused either by an external revocation or by independent findings, and in turn the internal revocation potentially effects an external revocation.

Certificate Renewal

A certificate renewal is the combination of a revocation of the existing certificate and an issuance of another certificate.

Note that XenMobile first attempts to obtain the new certificate before revoking the previous certificate, in order to avoid discontinuation of service if the issuance fails. If distributed (SCEP-supported) delivery is used, the revocation also only happens after the certificate has been successfully installed on the device; otherwise, the revocation occurs before the new certificate is sent to the device and independently of the success or failure of its installation.

The revocation configuration requires that you specify a certain duration (in days). When the device connects, the server verifies whether the certificate NotAfter date is later than the current date, minus the specified duration. If it is, a renewal is attempted.

Create a credential provider

Configuring a credential provider varies mostly as a factor of which issuing entity and which issuing method you select for the credential provider. You can distinguish between credential providers that use an internal entity and an external entity.

- A discretionary entity, which is internal to XenMobile, is an internal entity. The issuing method for a discretionary entity is always sign, meaning that with each issuing operation, XenMobile signs a new key pair with the CA certificate selected for the entity. Whether the key pair is generated on the device or on the server depends on the distribution method you select.
- An external entity, which is part of your corporate infrastructure, includes Microsoft CA or a GPKI.

For detailed information about setting up Symantec Managed PKI, including creating the credential provider, see "Symantec

Managed PKI" in [PKI entities](#).

1. In the XenMobile web console, click the gear icon in the upper-right corner of the console and then click **More > Credential Providers**.

2. On the **Credential Providers** page, click **Add**.

The **Credential Providers: General Information** page appears.

3. On the **Credential Providers: General Information** page, do the following:

- **Name:** Type a unique name for the new provider configuration. This name is used later to refer to the configuration in other parts of the XenMobile console.
- **Description:** Describe the credential provider. Although this is an optional field, a description can be useful in the future to help you remember details about this credential provider.
- **Issuing entity:** Click the certificate issuing entity.
- **Issuing method:** Click **Sign** or **Fetch** to serve as the method that the system uses to obtain certificates from the configured entity. For client certificate authentication, use **Sign**.
- If the **Template** list is available, select the template that you added under the PKI entity for the credential provider.

4. Click **Next**.

Note: These templates become available when Microsoft Certificate Services Entities are added at **Settings > PKI Entities**.

The **Credential Providers: Certificate Signing Request** page appears.

5. On the **Credential Providers: Certificate Signing Request** page, configure the following according to your certificate configuration:

- **Key algorithm:** Choose the key algorithm for the new key pair. Available values are **RSA**, **DSA** and **ECDSA**.
- **Key size:** Type the size, in bits, of the key pair. This is a required field.
Note: The permissible values depend on the key type; for instance, the maximum size for DSA keys is 1024 bits. To avoid false negatives, which will depend on the underlying hardware and software, XenMobile does not enforce key sizes. You should always test credential provider configurations in a test environment before activating them in production.
- **Signature algorithm:** Click a value for the new certificate. Values are dependent on the key algorithm.
- **Subject name:** Type the Distinguished Name (DN) of the new certificate subject. For example: `CN=${user.username}, OU=${user.department}, O=${user.companyname}, C=${user.c}`. This is a required field.

For example, for client certificate authentication, use these settings:

Key algorithm: RSA

Key size: 2048

Signature algorithm: SHA1withRSA

Subject name: `cn=${user.username}`

6. To add a new entry to the **Subject alternative names** table, click **Add**. Select the type of alternative name and then type a value in the second column.

For client certificate authentication, specify:

Type: User Principal name

Value: \$user.userprincipalname

Note: As with Subject name, you can use XenMobile macros in the value field.

7. Click **Next**.

The **Credential Providers: Distribution** page appears.

8. On the **Credential Providers: Distribution** page, do the following:

- In the **Issuing CA certificate** list, click the offered CA certificate. Because the credential provider uses a discretionary CA entity, the CA certificate for the credential provider is always be the CA certificate configured on the entity itself; it will be presented here for consistency with configurations that use external entities.
- In **Select distribution mode**, click one of the following ways of generating and distributing keys:
 - **Prefer centralized: Server-side key generation.** Citrix recommends this centralized option. It supports all platforms supported by XenMobile and is required when using NetScaler Gateway authentication. The private keys are generated and stored on the server and distributed to user devices.
 - **Prefer distributed: Device-side key generation.** The private keys are generated and stored on the user devices. This distributed mode uses SCEP and requires an RA encryption certificate with the keyUsage keyEncryption and an RA signing certificate with the KeyUsage digitalSignature. The same certificate can be used for both encryption and signing.
 - **Only distributed: Device-side key generation.** This option works the same as Prefer distributed: Device-side key generation, except that since it is "Only," rather than "Prefer," no option is available if device-side key generation fails or is unavailable.

If you selected **Prefer distributed: Device-side key generation** or **Only distributed: Device-side key generation**, click the RA signing certificate and RA encryption certificate. The same certificate can be used for both. New fields appear for these certificates.

9. Click **Next**.

The **Credential Providers: Revocation XenMobile** page appears. On this page, you configure the conditions under which XenMobile internally flags certificates, issued through this provider configuration, as revoked.

12. On the **Credential Providers: Revocation XenMobile** page, do the following:

- In **Revoke issued certificates**, select one of the options indicating when certificates should be revoked.
- If you would like XenMobile to send a notification when the certificate is revoked, set the value of **Send notification** to **On** and choose a notification template.
- If you would like to revoke the certificate on PKI when the certificate has been revoked from XenMobile, set **Revoke certificate on PKI** to **On** and, in the **Entity list**, click a template. The Entity list shows all the available GPKI entities with revocation capabilities. When the certificate is revoked from XenMobile, a revocation call is sent to the PKI selected from the Entity list.

13. Click **Next**.

The **Credential Providers: Revocation PKI** page appears. On this page, you identify what actions to take on the PKI if the certificate is revoked. You also have the option of creating a notification message.

14. On the **Credential Providers: Revocation PKI** page, do the following if you want to revoke certificates from the PKI:

- Change the setting of **Enable external revocation checks** to **On**. Additional fields related to revocation PKI appear.
- In the **OCS responder CA certificate** list, click the distinguished name (DN) of the certificate's subject. **Note:** You can use XenMobile macros for the DN field values. For example: CN=\${user.username}, OU=\${user.department}, O=\${user.companyname}, C=\${user.c}\endquotation
- In the **When certificate is revoked** list, click one of the following actions to take on the PKI entity when the certificate is revoked:

Do nothing.

Renew the certificate.

Revoke and wipe the device.

- If you would like XenMobile to send a notification when the certificate is revoked, set the value of **Send notification** to **On**.

You can choose between two notification options:

- If you select **Select notification template**, you can select a pre-written notification message which you can then customize. These templates are in the Notification template list.
- If you select **Enter notification details**, you can write your own notification message. In addition to providing the recipient's email address and the message, you can set how often the notification is sent.

15. Click **Next**.

The **Credential Providers: Renewal** page appears. On this page, you can configure XenMobile to do the following:

- Renew the certificate, optionally sending a notification when this is done (notification on renewal), and optionally excluding already expired certificates from the operation.
- Issue a notification for certificates that near expiration (notification before renewal).

16. On the **Credential Providers: Renewal** page, do the following if you want to renew certificates when they expire: Set **Renew certificates** when they expire to **On**.

Additional fields appear.

- In the **Renew when the certificate comes within** field, type how many days prior to expiration the renewal should be made.
- Optionally, select **Do not renew certificates that have already expired**. **Note:** In this case, "already expired" means that the certificate's NotAfter date is in the past, not that it has been revoked. XenMobile will not renew certificates once they have been internally revoked.

17. If you want XenMobile to send a notification when the certificate has been renewed, set **Send notification** to **On**. You can choose between two notification options:

- If you select **Select notification template**, you can select a pre-written notification message which you can then customize. These templates are in the Notification template list.
- If you select **Enter notification details**, you can write your own notification message. In addition to providing the recipient's email address and the message, you can set how often the notification is sent.

18. If you want XenMobile to send a notification when the certification nears expiration, set **Notify when certificate nears expiration** to **On**. You can choose between two notification options:

- If you select **Select notification template**, you can select a pre-written notification message which you can then customize. These templates are in the **Notification template** list.
- If you select **Enter notification details**, you can write your own notification message. In addition to providing the recipient's email address and the message, you can set how often the notification is sent.

19. In the **Notify when the certificate comes within** field, type how many days prior to the certificate's expiration the notification should be sent.

20. Click **Save**.

The credential provider is added to the Credential Provider table.

APNs certificates

Jun 19, 2017

In order to enroll and manage iOS devices with XenMobile, you need to set up and create an Apple Push Notification service (APNs) certificate from Apple. This section outlines the following basic steps for requesting the APNs certificate:

- Use a Windows Server 2012 R2 or Windows 2008 R2 Server and Microsoft Internet Information Server (IIS) or a Mac computer to generate a Certificate Signing Request (CSR).
- Have Citrix sign the CSR.
- Request an APNs certificate from Apple.
- Import the certificate to XenMobile.

Note:

- The APNs certificate from Apple enables mobile device management via the Apple Push Network. If you accidentally or intentionally revoke the certificate, you will lose the ability to manage your devices.
- If you used the iOS Developer Enterprise Program to create a mobile device manager push certificate, you may need to take action due to the migration of existing certificates to the Apple Push Certificates Portal.

The topics that outline the step-by-step procedures are listed in order in this section as follows:

Step 1	Create a CSR on IIS Create a CSR on a Mac	Generate a CSR with a Windows Server 2012 R2 or Windows 2008 R2 Server and Microsoft IIS or on a Mac computer. Citrix recommends this method.
Step 2	To sign the CSR	Submit the CSR to Citrix at the XenMobile APNs CSR Signing website (MyCitrix ID required). Citrix signs the CSR with its mobile device management signing certificate and returns the signed file in a .plist format.
Step 3	Submit Signed CSR to Apple	Submit the signed CSR to Apple at Apple Push Certificate Portal (Apple ID required) and then download the APNs certificate from Apple.
Step 4	To create a .pfx APNs certificate by using Microsoft IIS To create a .pfx APNs certificate on a Mac computer Create a .pfx APNs certificate by using OpenSSL	Export the APNs certificate as a PKCS #12 (.pfx) certificate (on IIS, Mac, or SSL).
Step 5	Import an APNs certificate into XenMobile	Import the certificate into XenMobile.

Apple MDM Push Certificate Migration Information

Mobile device management (MDM) push certificates created in the iOS Developer Enterprise Program have been migrated to the Apple Push Certificates Portal. This migration affects the creation of new MDM push certificates and the renewal, revocation, and downloading of existing MDM push certificates. The migration does not affect other (non-MDM) APNs certificates.

If your MDM push certificate was created in the iOS Developer Enterprise Program, the following situations apply:

- The certificate has been migrated for you automatically.
- You can renew the certificate in the Apple Push Certificates Portal without affecting your users.
- You need to use the iOS Developer Enterprise Program to revoke or download a preexisting certificate.

If none of your MDM push certificates is near expiration, you don't need to do anything. If you do have an MDM push certificate that is approaching expiration, contact your MDM solution provider. Then, have your iOS Developer Program Agent log on to the Apple Push Certificates Portal with their Apple ID.

All new MDM push certificates must be created in the Apple Push Certificates Portal. The iOS Developer Enterprise Program will no longer allow the creation of an App ID with a Bundle Identifier (APNs topic) that contains com.apple.mgmt.

Note: You must keep track of the Apple ID used to create the certificate. In addition, the Apple ID should be a corporate ID and not a personal ID.

To create a CSR by using Microsoft IIS

The first step for generating an APNs certificate request for iOS devices is to create a Certificate Signing Request (CSR). On a Windows 2012 R2 or Windows 2008 R2 Server, you can generate a CSR by using Microsoft IIS.

1. Open Microsoft IIS.
2. Double-click the Server Certificates icon for IIS.
3. In the Server Certificates window, click **Create Certificate Request**.
4. Type the appropriate Distinguished Name (DN) information and then click **Next**.
5. Select **Microsoft RSA SChannel Cryptographic Provider** for the Cryptographic Service Provider and **2048** for bit length and then click **Next**.
6. Enter a file name and specify a location to save the CSR and then click **Finish**.

To create a CSR on a Mac computer

1. On a Mac computer running macOS, under **Applications > Utilities**, start the Keychain Access application.
2. Open the **Keychain Access** menu and then click **Preferences**.
3. Click the **Certificates** tab, change the options for **OCSP** and **CRL** to **Off** and then close the Preferences window.
4. On the **Keychain Access** menu, click **Certificate Assistant > Request a Certificate From a Certificate Authority**.
5. The Certificate Assistant prompts you to enter the following information:
 1. **Email Address**. Email address of the individual or role account who is responsible for managing the certificate.
 2. **Common Name**. Common name of the individual or a role account who is responsible for managing the certificate.
 3. **CA Email Address**. Email address of the Certificate Authority.
6. Select the **Saved to disk** and **Let me specify key pair information** options and then click **Continue**.
7. Enter a name for the CSR file, save the file on your computer and then click **Save**.
8. Specify the key pair information by selecting the **Key Size** of 2048 bits and the **RSA algorithm** and then click **Continue**. The CSR file is ready for you to upload as part of the APNs certificate process.

9. Click **Done** when the Certificate Assistant completes the CSR process.

To create a CSR by using OpenSSL

If you cannot use a Windows 2012 R2 or Windows 2008 R2 Server and Microsoft Internet Information Server (IIS) or a Mac computer to generate a Certificate Signing Request (CSR) to submit to Apple for the Apple Push Notification service (APNs) certificate, you can use OpenSSL.

Note: In order to use OpenSSL to create a CSR, you need to first download and install OpenSSL from the OpenSSL website.

1. On the computer where you installed OpenSSL, execute the following command from a command prompt or shell.
openssl req -new -keyout Customer.key.pem -out CompanyAPNScertificate.csr -newkey rsa:2048

2. The following message for certificate naming information appears. Enter the information as requested.

You are about to be asked to enter information that will be incorporated into your certificate request.

What you are about to enter is what is called a Distinguished Name or a DN.

There are quite a few fields but you can leave some blank

For some fields there will be a default value,

If you enter '.', the field will be left blank.

Country Name (2 letter code) [AU]:US

State or Province Name (full name) [Some-State]:CA

Locality Name (eg, city) []:RWC

Organization Name (eg, company) [Internet Widgits Pty Ltd]:Customer

Organizational Unit Name (eg, section) []:Marketing

Common Name (eg, YOUR name) []:John Doe

Email Address []:john.doe@customer.com

3. At the next message, enter a password for the CSR private key.

Please enter the following 'extra' attributes to be sent with your certificate request

A challenge password []:

An optional company name []:

4. Send the resulting CSR to Citrix.

Citrix prepares the signed CSR and returns the file to you through email.

To sign the CSR

Before you can submit the certificate to Apple, it needs to be signed by Citrix so it can be used with XenMobile.

1. In your browser, go to the [XenMobile APNs CSR Signing](#) website.

2. Click **Upload the CSR**.

3. Browse to and select the certificate.

Note: The certificate must be in .pem/.txt format.

4. On the XenMobile APNs CSR Signing page, click **Sign**. The CSR is signed and automatically saved to your configured download folder.

To submit the signed CSR to Apple to obtain the APNs certificate

After receiving your signed Certificate Signing Request (CSR) from Citrix, you need to submit it to Apple to obtain the APNs certificate.

Note: Some users have reported problems logging into the Apple Push Portal. As an alternative, you can log on to the Apple Developer Portal (<http://developer.apple.com/devcenter/ios/index.action>) before going to the identity.apple.com link in Step 1.

1. In a browser, go to <https://identity.apple.com/pushcert>.
2. Click **Create a Certificate**.
3. If this is the first time you are creating a certificate with Apple, select the **I have read and agree to these terms and conditions** check box and then click **Accept**.
4. Click **Choose File**, browse to the signed CSR on your computer and then click **Upload**. A confirmation message should appear stating that the upload is successful.
5. Click **Download** to retrieve the .pem certificate.

Note: If you are using Internet Explorer and the file extension is missing, click **Cancel** two times and then download from the next window.

To create a .pfx APNs certificate by using Microsoft IIS

To use the APNs certificate from Apple with XenMobile, you need to complete the certificate request in Microsoft IIS, export the certificate as a PKCS #12 (.pfx) file and then import the APNs certificate into XenMobile.

Important: You need to use the same IIS server for this task as the server you used to generate the CSR.

1. Open Microsoft IIS.
2. Click the Server Certificates icon.
3. In the **Server Certificates** window, click **Complete Certificate Request**.
4. Browse to the Certificate.pem file from Apple. Then, type a friendly name or the certificate name and click **OK**.
5. Select the certificate that you identified in Step 4 and then click **Export**.
6. Specify a location and file name for the .pfx certificate and a password and then click **OK**.
Note: You will need the password for the certificate during the installation of XenMobile.
7. Copy the .pfx certificate to the server on which XenMobile will be installed.
8. Sign on to the XenMobile console as an administrator.
9. In the XenMobile console, click the gear icon in the upper-right corner of the console. The **Settings** page appears.
10. Click **Certificates**. The **Certificates** page appears.
11. Click **Import**. The **Import** dialog box appears.
12. From the **Import** menu, choose **Keystore**.
13. From **Use as**, choose **APNs**.
14. In **Keystore** file, select the keystore file you want to import by clicking **Browse** and navigating to the file's location.
15. In **Password**, type the password assigned to the certificate.
16. Click **Import**.

To create a .pfx APNs certificate on a Mac computer

1. On the same Mac computer running macOS that you used to generate the CSR, locate the Production identity (.pem) certificate that you received from Apple.
2. Double-click the certificate file to import the file into the keychain.

3. If you are prompted to add the certificate to a specific keychain, keep the default login keychain selected and then click **OK**. The newly added certificate will appear in your list of certificates.
4. Click the certificate and then on the **File** menu, click **Export** to begin exporting the certificate into a PCKS #12 (.pfx) certificate.
5. Give the certificate file a unique name for use with the XenMobile server, choose a folder location for the saved certificate, select the .pfx file format and then click **Save**.
6. Enter a password for exporting the certificate. Citrix recommends that you use a unique, strong password. Also, be sure to keep the certificate and password safe for later use and reference.
7. The Keychain Access application will prompt you for the login password or selected keychain. Enter the password and then click **OK**. The saved certificate is now ready for use with the XenMobile server.

Note: If you don't plan to keep and preserve the computer and user account that you originally used to generate the CSR and complete the certificate export process, Citrix recommends that you save or export the Personal and Public Keys from the local system. Otherwise, access to the APNs certificates for reuse will be voided and you will have to repeat the entire CSR and APNs process.

To create a .pfx APNs certificate by using OpenSSL

After you use OpenSSL to create a Certificate Signing Request (CSR), you can also use OpenSSL to create a .pfx APNs certificate.

1. At a command prompt or shell, execute the following command.
openssl pkcs12 -export -in MDM_Zenprise_Certificate.pem -inkey Customer.key.pem -out apns_identity.p12
2. Enter a password for the .pfx certificate file. Remember this password because you need to use the password again when you upload the certificate to XenMobile.
3. Note the location for the .pfx certificate file and then copy the file to the XenMobile server, so you can use the XenMobile console to upload the file.

To import an APNs certificate into XenMobile

After you have requested and received a new APNs certificate, you import the APNs certificate into XenMobile to either add the certificate for the first time or to replace an existing certificate.

1. In the XenMobile console, click the gear icon in the upper-right corner of the console. The **Settings** page appears.
2. Click **Certificates**. The **Certificates** page appears.
3. Click **Import**. The **Import** dialog box appears.
4. From the **Import** menu, choose **Keystore**.
5. From **Use as**, choose **APNs**.
6. Browse to the .p12 file on your computer.
7. Enter a password and then click **Import**.

For more information about certificates in XenMobile, see the [Certificates](#) section.

To renew an APNs certificate

To renew an APNs certificate, you need to perform the same steps you would if you were creating a new certificate. Then, you visit the [Apple Push Certificates Portal](#) and upload the new certificate. After logging on, you see your existing certificate or you may see a certificate that was imported from your previous Apple Developers account. On the Certificates Portal, the only difference when renewing the certificate is that you click **Renew**. You must have a developer account with the Certificates Portal in order to access the site. When you are renewing your certificate, ensure that you

use the same organisation name and Apple ID.

Note: To determine when your APNs certificate expires, in the XenMobile console, click **Configure > Settings > Certificates**. If the certificate is expired, however, do not revoke the certificate.

1. Generate a CSR using Microsoft Internet Information Services (IIS).
2. At the [XenMobile APNs CSR Signing](#) website, upload the new CSR and then click **Sign**.
3. Submit the signed CSR to Apple at [Apple Push Certificate Portal](#).
4. Click **Renew**.
5. Generate a PCKS #12 (.pfx) APNs certificate using Microsoft IIS.
6. Update the new APNs certificate in the XenMobile console. Click the gear icon in the upper-right corner of the console. The **Settings** page appears.
7. Click **Certificates**. The **Certificates** page appears.
8. Click **Import**. The **Import** dialog box appears.
9. From the **Import** menu, choose **Keystore**.
10. From **Use as**, choose **APNs**.
11. Browse to the .p12 file on your computer.
12. Enter a password and then click **Import**.

SAML for single sign-on with ShareFile

Jun 19, 2017

You can configure XenMobile and ShareFile to use Security Assertion Markup Language (SAML) to provide single sign-on (SSO) access to ShareFile mobile apps. This functionality includes ShareFile apps that are wrapped with the MDX toolkit and non-wrapped ShareFile clients, such as the web site, Outlook plugin, or sync clients.

- **For wrapped ShareFile apps.** Users who log on to ShareFile through the ShareFile mobile app are redirected to Secure Hub for user authentication and to acquire a SAML token. After successful authentication, the ShareFile mobile app sends the SAML token to ShareFile. After the initial log on, users can access the ShareFile mobile app through SSO and can attach documents from ShareFile to Secure Mail emails without logging on each time.
- **For non-wrapped ShareFile clients.** Users who log on to ShareFile using a web browser or other ShareFile client are redirected to XenMobile for user authentication and to acquire a SAML token. After successful authentication, the SAML token is sent to ShareFile. After the initial log on, users can access ShareFile clients through SSO without logging on each time.

To use XenMobile as a SAML identity provider (IdP) to ShareFile, you must configure XenMobile to use ShareFile Enterprise, as described in this article. Alternatively, you can configure XenMobile to work only with StorageZone Connectors. For more information, see [ShareFile use with XenMobile](#).

For a detailed reference architecture diagram, see the XenMobile Deployment Handbook article, [Reference Architecture for On-Premises Deployments](#).

Prerequisites

You must complete the following prerequisites before you can configure SSO with XenMobile and ShareFile apps:

- A compatible version of the MDX Toolkit (for ShareFile mobile apps)
- A compatible version of ShareFile mobile apps and Secure Hub
- ShareFile administrator account

Verify connectivity between XenMobile and ShareFile.

Configure ShareFile access

Before setting up SAML for ShareFile, provide ShareFile access information as follows:

1. In the XenMobile web console, click **Configure > ShareFile**. The **ShareFile** configuration page appears.

XenMobile Analyze Manage **Configure**

Device Policies Apps Actions **ShareFile** Enrollment Profiles Delivery Groups

ShareFile

Configure settings to connect to the ShareFile account and administrator service account for user account management.

Domain*

Assign to delivery groups

AllUsers

Selected delivery groups

AllUsers

ShareFile Administrator Account Logon

User name*

Password*

User account provisioning

SAML certificate

Name XMS.example.com

Advanced ShareFile Configuration

2. Configure these settings:

- **Domain:** Type your ShareFile subdomain name; for example example.sharefile.com.
- **Assign to delivery groups:** Select or search for the delivery groups that you want to be able to use SSO with ShareFile.
- **ShareFile Administrator Account Logon**
 - **User name:** Type the ShareFile administrator user name. This user must have administrator privileges.
 - **Password:** Type the ShareFile administrator password.
 - **User account provisioning:** Turn on this option if you want to enable user provisioning in XenMobile; leave it disabled if you plan to use the ShareFile User Management Tool for user provisioning.

Note: If a user without a ShareFile account is included in the selected roles, XenMobile automatically provisions a ShareFile account for that user if you enable User account provisioning. Citrix recommends that you use a role with a small membership for testing the configuration. Doing so avoids the potential of a large number of users without ShareFile accounts.

3. Click **Test Connection** to verify that the user name and password for the ShareFile administrator account authenticate to the specified ShareFile account.

4. Click **Save**. XenMobile syncs with ShareFile and updates the ShareFile settings **ShareFile Issuer/Entity ID** and **Login URL**.

Set up SAML for Wrapped ShareFile MDX Apps

The following steps apply to iOS and Android apps and devices.

1. With the MDX Toolkit, wrap the ShareFile mobile app. For more information about wrapping apps with the MDX Toolkit, see [Wrapping Apps with the MDX Toolkit](#).
2. In the XenMobile console, upload the wrapped ShareFile mobile app. For information about uploading MDX apps, see [To add an MDX app to XenMobile](#).
3. Verify the SAML settings by logging on to ShareFile with the administrator user name and password you configured above.
4. Verify that ShareFile and XenMobile are configured for the same time zone.

Note: Make sure that XenMobile shows the correct time with regard to the configured time zone. If not, SSO failure may occur.

Validate the ShareFile mobile app

1. On the user device, if it has not already been done, install and configure Secure Hub.
2. From the XenMobile Store, download and install the ShareFile mobile app.
3. Start the ShareFile mobile app. ShareFile starts without prompting for user name or password.

Validate with Secure Mail

1. On the user device, if it has not already been done, install and configure Secure Hub.
2. From the XenMobile Store, download, install, and set up Secure Mail.
3. Open a new email form and then tap **Attach from ShareFile**. Files available to attach to the email are shown without asking for user name or password.

Configure the NetScaler Gateway for Other ShareFile Clients

If you want to configure access for non-wrapped ShareFile clients, such as the web site, Outlook plugin, or the sync clients, you must configure NetScaler Gateway to support the use of XenMobile as a SAML identity provider as follows:

- Disable home page redirection.
- Create a ShareFile session policy and profile.
- Configure policies on the NetScaler Gateway virtual server.

Disable home page redirection

You must disable the default behavior for requests that come through the /cginfra path so that the user sees the original requested internal URL instead of the configured home page.

1. Edit the settings for the NetScaler Gateway virtual server that is used for XenMobile logons. In NetScaler 10.5, go to **Other Settings** and then clear the check box labeled **Redirect to Home Page**.

Other Settings [X]

ICMP Virtual Server Response*
 Passive

RHI State*
 Passive

Redirect to Home page

Listen Priority
 []

Listen Policy Expression Expression Editor

Operators | Saved Policy Expressions | Frequently Used Expressions | Clear

Press Control+Space to start the expression and then type '.' to get the next set of options

Evaluate

ShareFile
 xms.citrix.lab:8443 +

AppController
 https://xms.citrix.lab:8443

L2 Connection

OK

2. Under **ShareFile**, type your XenMobile internal server name and port number.

3. Under **AppController**, type your XenMobile URL.

This configuration authorizes requests to the URL you entered through the /cginfra path.

Create a ShareFile session policy and request profile

Configure these settings to create a ShareFile session policy and request profile:

1. In the NetScaler Gateway configuration utility, in the left-hand navigation pane, click **NetScaler Gateway > Policies > Session**.
2. Create a new session policy. On the **Policies** tab, click **Add**.
3. In the **Name** field, type **ShareFile_Policy**.
4. Create a new action by clicking the + button. The **Create NetScaler Gateway Session Profile** page appears.

Configure NetScaler Gateway Session Profile

Configure NetScaler Gateway Session Profile

Name
Sharefile_Profile

Unchecked Override Global check box indicates that the value is inherited from Global NetScaler Gateway Parameters.

Network Configuration **Client Experience** Security Published Applications

Accounting Policy
[Dropdown]

Override Global

Display Home Page

Home Page
none

URL for Web-Based Email
[Text Box]

Split Tunnel*
OFF

Session Time-out (mins)
1

Client Idle Time-out (mins)
[Text Box]

Clientless Access*
Allow

Clientless Access URL Encoding*
Obscure

Clientless Access Persistent Cookie*
DENY

Plug-in Type*
Windows/MAC OS X

Single Sign-on to Web Applications

Credential Index*
PRIMARY

KCD Account
[Text Box]

Single Sign-on with Windows*

Configure these settings:

- **Name:** Type ShareFile_Profile.
- Click the **Client Experience** tab and then configure these settings:
 - **Home Page:** Type none.
 - **Session Time-out (mins):** Type 1.
 - **Single Sign-on to Web Applications:** Select this setting.
 - **Credential Index:** In the list, click PRIMARY.
- Click the **Published Applications** tab.

Configure NetScaler Gateway Session Profile

Name
Sharefile_Profile

Unchecked Override Global check box indicates that the value is inherited from Global NetScaler Gateway Parameters.

Network Configuration Client Experience Security **Published Applications**

Override Global

ICA Proxy*
ON

Web Interface Address
https://xms.citrix.lab:8443 ?

Web Interface Address Type*
IPV4

Web Interface Portal Mode*
NORMAL

Single Sign-on Domain
citrix

Citrix Receiver Home Page

Account Services Address

OK Close

Configure these settings:

- **ICA Proxy:** In the list, click **ON**.
- **Web Interface Address:** Type your XenMobile server URL.
- **Single Sign-on Domain:** Type your Active Directory domain name.

Note: When configuring the NetScaler Gateway Session Profile, the domain suffix for **Single Sign-on Domain** must match the XenMobile domain alias defined in LDAP.

5. Click **Create** to define the session profile.

6. Click **Expression Editor**.

← Back

Create NetScaler Gateway Session Policy

Name*
ShareFile_Policy

Action*
Sharefile_Profile

Expression*
Operators Saved Policy Expressions Freq

Create Close

Add Expression

Select Expression Type: General

Flow Type
REQ

Protocol
HTTP

Qualifier
HEADER

Operator
CONTAINS

Value*
NSC_FSRD

Header Name*
COOKIE

Length

Offset

Done Cancel

Expression Editor
Clear

Configure these settings:

- **Value:** Type NSC_FSRD.
- **Header Name:** Type COOKIE.
- Click **Done**.

7. Click **Create** and then click **Close**.

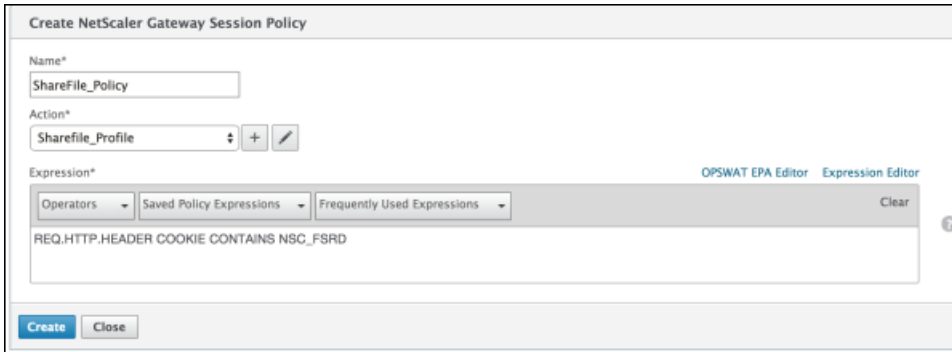

Configure policies on the NetScaler Gateway virtual server

Configure these settings on the NetScaler Gateway virtual server.

1. In the NetScaler Gateway configuration utility, in the left-hand navigation pane, click **NetScaler Gateway > Virtual Servers**.
2. In the **Details** pane, click your NetScaler Gateway virtual server.
3. Click **Edit**.
4. Click **Configured policies > Session policies** and then click **Add binding**.
5. Select **ShareFile_Policy**.
6. Edit the auto-generated **Priority** number for the selected policy so that it has the highest priority (the smallest number) in relation to any other policies listed, as shown in the following figure.

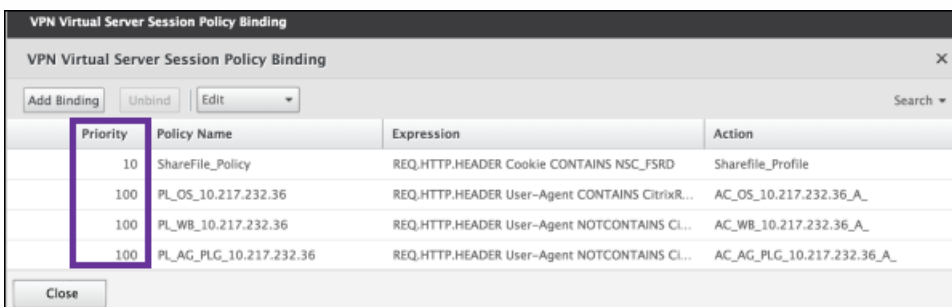

Priority	Policy Name	Expression	Action
10	ShareFile_Policy	REQ.HTTP.HEADER Cookie CONTAINS NSC_FSRD	Sharefile_Profile
100	PL_OS_10.217.232.36	REQ.HTTP.HEADER User-Agent CONTAINS CitrixR...	AC_OS_10.217.232.36_A_
100	PL_WB_10.217.232.36	REQ.HTTP.HEADER User-Agent NOTCONTAINS Cl...	AC_WB_10.217.232.36_A_
100	PL_AG_PLG_10.217.232.36	REQ.HTTP.HEADER User-Agent NOTCONTAINS Cl...	AC_AG_PLG_10.217.232.36_A_

7. Click **Done** and then save the running NetScaler configuration.

Configure SAML for non-MDX ShareFile apps

Use the following steps to find the internal app name for your ShareFile configuration.

1. Log on to the XenMobile administrator tool using the URL <https://<XenMobile server>:4443/OCA/admin/>. Be sure to enter "OCA" in uppercase letters.
2. In the **View** list, click **Configuration**.

3. Click **Applications > Applications** and note the **Application Name** for the app with the **Display Name** "ShareFile".

Application Name	Display Name	Description
activedirectory	activedirectory	
AmericanExpress	AmericanExpress	Online access to world-class card, financial, insu...
Fidelity	Fidelity	Your Personal Investing Resource
LinkedIn	LinkedIn	Business-oriented social networking site
ShareFile_SAML	ShareFile	Online storage for business
MobileApp11	ShareFile_220	ShareFile 2.2.0
MobileApp13	ShareFile_iPhone_303	ShareFile 3.0.3

Modify the ShareFile.com SSO settings

1. Log on to your ShareFile account (<https://<subdomain>.sharefile.com>) as a ShareFile administrator.
2. In the ShareFile web interface, click **Admin** and then select **Configure Single Sign-on**.
3. Edit the **Login URL** as follows:

The **Login URL** should look similar to: https://xms.citrix.lab/samlsp/websso.do?action=authenticateUser&app=ShareFile_SAML_SP&reqtype=1.

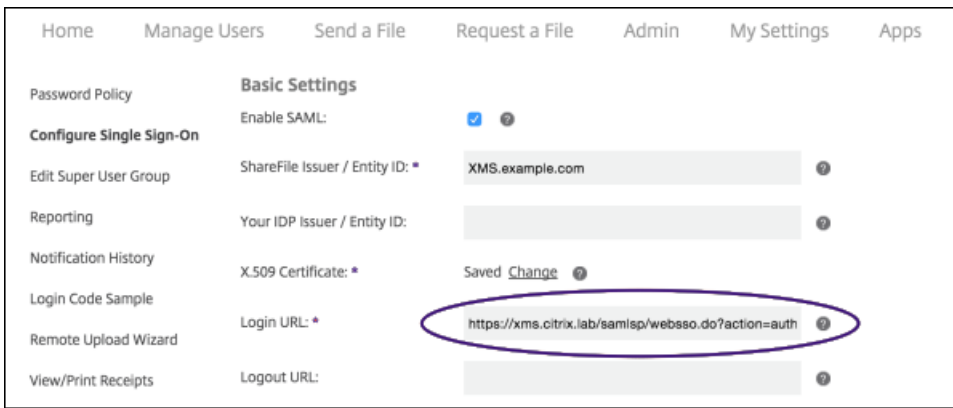

- Insert the NetScaler Gateway virtual server external FQDN plus "/cginfra/https/" in front of the XenMobile server FQDN and then add "8443" after the XenMobile FQDN.

The URL should now look similar to this:

`https://nsgateway.acme.com/cginfra/https/xms.citrix.lab:8443/samlsp/websso.do?action=authenticateUser&app=ShareFile_SAML_SP&reftype=1`

- Change the parameter **&app=ShareFile_SAML_SP** to the internal ShareFile application name from step 3 in [SAML for single sign-on with ShareFile](#). The internal name is **ShareFile_SAML** by default; however, every time you change your configuration, a number is appended to the internal name (ShareFile_SAML_2, ShareFile_SAML_3, and so on).

The URL should now look similar to this:

`https://nsgateway.acme.com/cginfra/https/xms.citrix.lab:8443/samlsp/websso.do?action=authenticateUser&app=ShareFile_SAML&reftype=1`

- Add "&nssso=true" to the end of the URL.

The modified URL should now look similar to:

`https://nsgateway.acme.com/cginfra/https/xms.citrix.lab:8443/samlsp/websso.do?action=authenticateUser&app=ShareFile_SAML&reftype=1&nssso=true.`

Important: Each time you edit or recreate the ShareFile app or change the ShareFile settings in the XenMobile console, a new number is appended the internal application name, which means you must also update the Login URL in the ShareFile web site to reflect the updated app name.

4. Under **Optional Settings**, select the **Enable Web Authentication** check box.

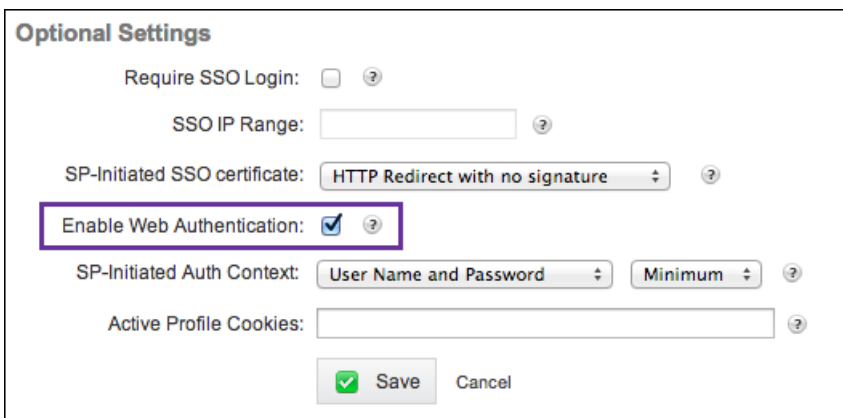

Validate the configuration

Do the following to validate the configuration.

1. Point your browser to <https://<subdomain>sharefile.com/saml/login>.

You are redirected to the NetScaler Gateway log on form. If you are not redirected, verify the preceding configuration settings.

2. Enter the user name and password for the NetScaler Gateway and XenMobile environment you configured.

Your ShareFile folders at <subdomain>.sharefile.com appear. If you do not see your ShareFile folders, make sure you entered the proper logon credentials.

Azure Active Directory as IDP

Jun 19, 2017

Configuring Azure Active Directory (AD) as your identity provider (IDP) lets users enroll in XenMobile using their Azure credentials.

iOS, Android, and Windows 10 devices are supported. iOS and Android devices enroll through Secure Hub.

You configure Azure as your IDP under **Settings > Authentication > IDP**. The **IDP** page is new to this version of XenMobile. In previous versions of XenMobile, you configured Azure under **Settings > Microsoft Azure**.

Requirements

Versions and licenses

- To enroll iOS or Android devices, you need Secure Hub 10.5.5.
- To enroll Windows 10 devices, you need Microsoft Azure Premium licenses.

Directory services and authentication

- XenMobile Server must be configured for certificate-based authentication.
- If you are using NetScaler for authentication, NetScaler must be configured for certificate-based authentication.
- Secure Hub authentication uses Azure AD and honors the authentication mode defined on Azure AD.
- XenMobile Server must connect to Windows Active Directory (AD) using LDAP. Configure your local LDAP server to sync with Azure AD.

Authentication flow

When device enrolls through Secure Hub and XenMobile is configured to use Azure as its IDP:

1. Users enter a user name and password, on their device, in the Azure AD login screen shown in Secure Hub.
2. Azure AD validates the user and sends an ID token.
3. Secure Hub shares the ID token with XenMobile Server.
4. XenMobile validates the ID token and the user information present in the ID token. XenMobile returns a session ID.

Azure account setup

To use Azure AD as your IDP, first log in to your Azure account and make these changes:

1. Register your custom domain and verify the domain. For details, see [Add your own domain name to Azure Active Directory](#).
2. Extend your on-premises directory to Azure Active Directory using directory integration tools. For details, see [Directory](#)

Integration.

To use Azure AD to enroll Windows 10 devices, make the following changes to your Azure account:

1. Make the MDM a reliable party of Azure AD. To do so, click **Azure Active Directory > Applications** and then click **Add**.
2. Select **Add an application** from the gallery. Go to **MOBILE DEVICE MANAGEMENT** and then select **on-premises MDM application**. Save the settings.

Note: You choose on-premises application even if you signed up for Citrix XenMobile cloud because in Microsoft terminology, any non-multi-tenant application is an on-premises MDM application.

3. In the application, configure XenMobile Server discovery, terms of use endpoints, and APP ID URI:
 - **MDM Discovery URL:** `https://<FQDN>:8443/zdm/wpe`
 - **MDM Terms of Use URL:** `https://<FQDN>:8443/zdm/wpe/tou`
 - **APP ID URI:** `https://<FQDN>:8443/`
4. Select the on-premises MDM application that you created in step 2. Enable the option, **Manage devices for these users**, to enable MDM management for all users or any specific user group.

For more information about using Azure AD to Windows 10 devices, see the Microsoft article [Azure Active Directory integration with MDM](#).

Configure Azure AD as your IDP

1. Locate or make note of the information you need from your Azure account:
 - Tenant ID from the Azure application settings page.
 - If you want to use Azure AD to enroll Windows 10 devices, you also need:
 - **App ID URI:** The URL for the server running XenMobile.
 - **Client ID:** The unique identifier for your app from the Azure Configure page.
 - **Key:** From the Azure application settings page.
2. In the XenMobile console, click the gear icon in the upper-right corner. The **Settings** page appears.
3. Under **Authentication**, click **Identity Provider (IDP)**. The **Identity Provider** page appears.

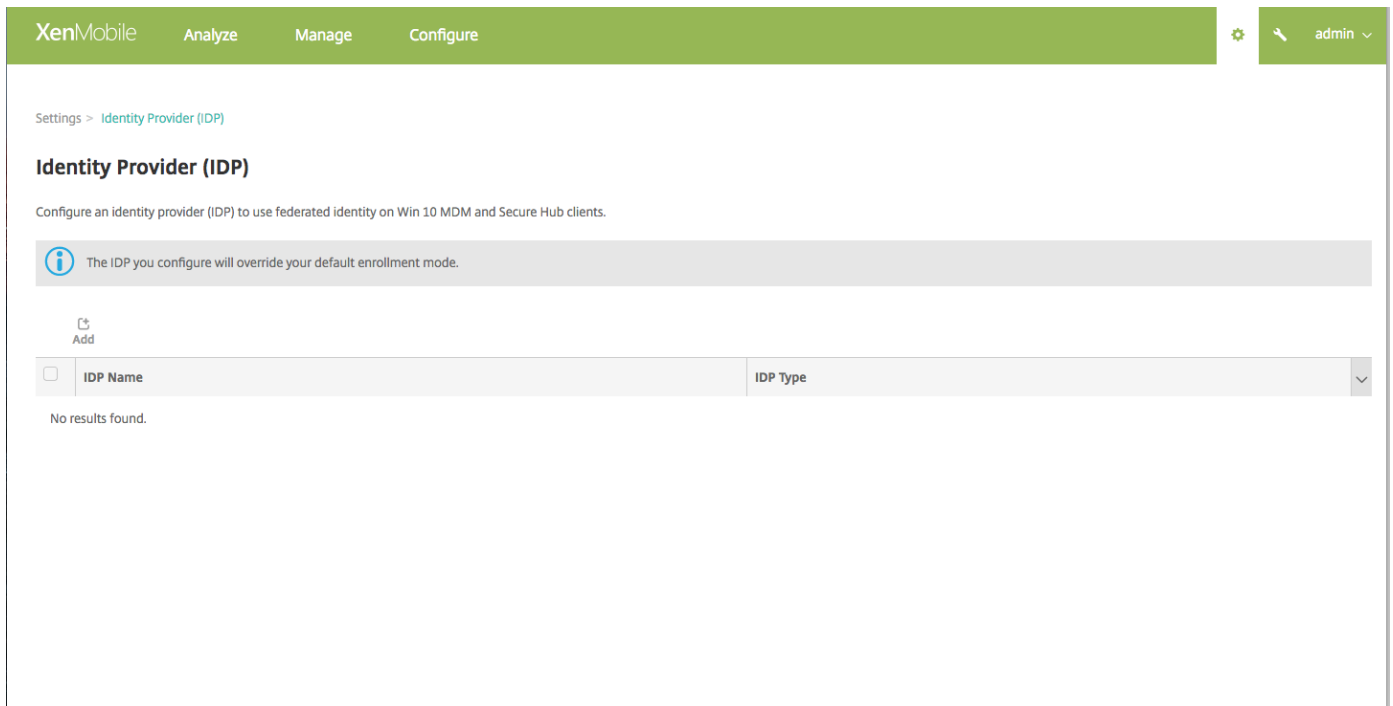

4. Click **Add**. The **IDP configuration** page appears.

5. Configure the following information about your IDP:

- **IDP Name:** Type a name for IDP connection you are creating.
- **IDP Type:** Choose Azure Active Directory as your IDP type.
- **Tenant ID:** Copy this value from the Azure application settings page. In the browser address bar, copy the section made up of numbers and letters.

For example, in

<https://manage.windowsazure.com/acmew.onmicrosoft.com#workspaces/ActiveDirectoryExtensin/Directory/abc213-abc123-abc123/onprem> ..., the tenant ID is: abc123-abc123-abc123.

XenMobile Analyze Manage Configure admin

Settings > Identity Provider (IDP) > Add IDP

Identity Provider (IDP)

- 1 Discovery URL
- 2 Client Type
- Win 10 MDM
- Secure Hub
- 3 IDP Claims Usage
- 4 Summary

Discovery URL

Set up a connection to your identity provider (IDP).

IDP Name*

IDP Type*

IDP Configuration

Tenant ID*

These fields are filled in automatically when you provide your tenant ID.

OpenID Connect Discovery endpoint (URL)

Authorize endpoint (URL)*

Token endpoint (URL)*

jwtks_uri (JSON Web Key Set URI)*

End Session endpoint (URL)

[Next >](#)

6. The rest of the fields automatically fill. When they are filled, click **Next**.
7. To configure XenMobile to enroll Windows 10 devices using Azure AD for MDM enrollment, configure the following settings. To skip this optional step, clear **Win 10 MDM**.
 - **App ID URI:** Type the URL for the XenMobile Server that you entered when you configured your Azure settings.
 - **Client ID:** Copy and paste this value from the Azure Configure page. The client ID is the unique identifier for your app.
 - **Key:** Copy this value from the Azure application settings page. Under keys, select a duration in the list and then save the setting. You can then copy the key and paste it into this field. A key is required when apps read or write data in Microsoft Azure AD.

The screenshot shows the XenMobile configuration interface. At the top, there is a navigation bar with 'XenMobile', 'Analyze', 'Manage', and 'Configure' tabs, and a user profile 'admin'. Below the navigation bar, the breadcrumb trail reads 'Settings > Identity Provider (IDP) > Add IDP'. On the left, a sidebar titled 'Identity Provider (IDP)' contains a list of steps: '1 Discovery URL', '2 Client Type', '3 Win 10 MDM' (which is selected and highlighted in teal), '4 Secure Hub', '5 IDP Claims Usage', and '6 Summary'. The main content area is titled 'Win 10 MDM Info' and includes the instruction: 'Integrate XenMobile with Azure Active Directory to let devices running Windows 10, enroll with Azure as a federated means of Active Directory authentication'. Below this, there are three input fields: 'App ID URI*' with the value 'http://www.example.com', 'Client ID*' with the value 'asdf-123-example-client-id', and 'Key*' with a masked value '.....'. Each field has a help icon to its right. At the bottom right of the main area, there are 'Back' and 'Next >' buttons.

8. Click **Next**.

Citrix has registered Secure Hub with Microsoft Azure and maintains the information. This screen shows the details used by Secure Hub to communicate with Azure Active Directory. This page will be used in the future if any of this information needs a change. Edit this page only if Citrix advises you to.

9. Click **Next**.

The screenshot shows the XenMobile configuration interface for the 'Secure Hub Info' step. The navigation bar and breadcrumb trail are the same as in the previous screenshot. The sidebar now highlights '4 Secure Hub'. The main content area is titled 'Secure Hub Info' and includes the instruction: 'Configure details that Secure Hub mobile client in Android and iOS platforms can use to authenticate using Azure AD.' Below this, there is an information banner that reads: 'Citrix has provided this information for Secure Hub to use to authenticate with Azure Active Directory.' Underneath, there are three input fields: 'Client ID*' with the value 'ab2e3468-aa05-4649-b6fa-e69a748baf88', 'Redirect_URI*' with the value 'com.citrix.securehub://oauth/redirect_uri', and 'Scopes*' with the value 'openid'. Each field has a help icon to its right. An 'Edit' button is located to the right of the Client ID field. At the bottom right of the main area, there are 'Back' and 'Next >' buttons.

10. Configure the type of user identifier your IDP is providing:

- **User Identifier type:** Choose **userPrincipalName** from the drop-down list.
- **User Identifier string:** This field is automatically filled.

11. Click **Next**.

The screenshot shows the 'IDP Claims Usage' configuration page in the XenMobile console. The left sidebar contains a navigation menu with four items: '1 Discovery URL', '2 Client Type', '3 IDP Claims Usage' (which is highlighted in light blue), and '4 Summary'. The main content area is titled 'IDP Claims Usage' and includes a sub-header 'Choose the type of user identifier that IDP is providing.' Below this is an information box stating: 'XenMobile uses the 'upn' key to retrieve the user information from the jwt token provided by Azure Active Directory.' There are two input fields: 'User Identifier type*' is a dropdown menu with 'userPrincipalName' selected, and 'User Identifier string*' is a text box containing '\$[id_token].upn'. At the bottom right, there are 'Back' and 'Next >' buttons.

12. Review the **Summary** page and click **Save**.

The screenshot shows the 'Summary' page of the 'IDP Claims Usage' configuration. The left sidebar is the same as in the previous screenshot, but '4 Summary' is now highlighted. The main content area displays a summary of the configuration in several sections:

- Token endpoint (URL):** https://login.windows.net/b660c141-8a83-4d92-b523-7f5a92c777b4/oauth2/token
- Jwtks_uri (JSON Web Key Set URI):** https://login.windows.net/common/discovery/keys
- End Session endpoint (URL):** https://login.windows.net/b660c141-8a83-4d92-b523-7f5a92c777b4/oauth2/logout
- Win 10 MDM:**
 - App ID URI:** http://www.example.com
 - Client ID:** asdf-123-example-client-id
 - Key:** *****
- Secure Hub Info:**
 - Client ID:** ab2e3468-aa05-4649-b6fa-e69a748baf88
 - Client Secret (optional):** N/A
 - Redirect_URI:** com.citrix.securehub://oauth/redirect_uri
 - Scopes:** openid
- IDP Claims Usage:**
 - User Identifier type:** userPrincipalName
 - User Identifier string:** \${id_token}.upn

 At the bottom right, there are 'Back' and 'Save' buttons.

What users experience

1. Users start Secure Hub. Users then enter the XenMobile Server Fully Qualified Domain Name (FQDN), a User Principle Name (UPN), or email address.

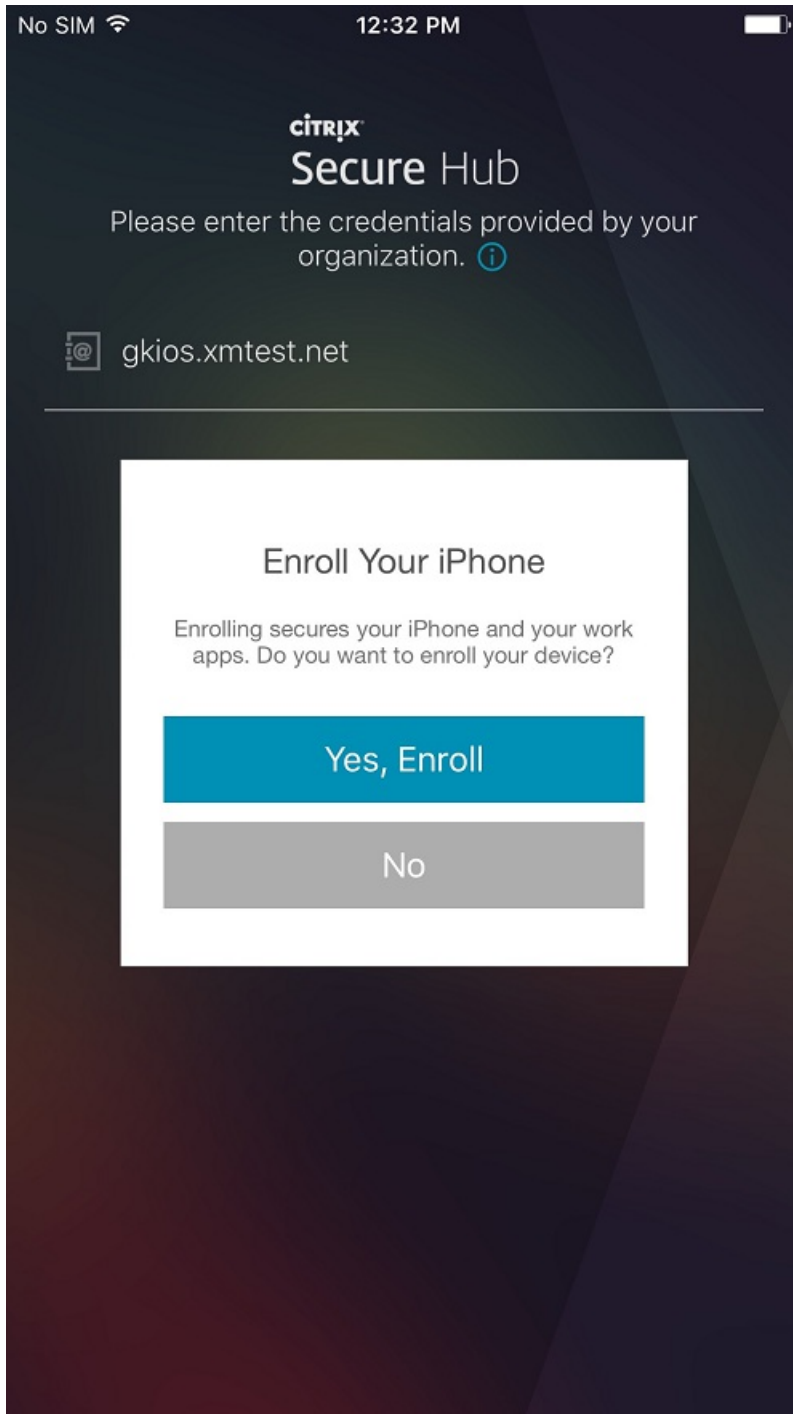

2. Users then click **Yes, Enroll**.

Cancel

Sign On

xmslab

Sign in with your organizational account

Sign in

© 2016 Microsoft

3. Users log on by using their Azure AD credentials.



Enrollment in progress ...

Enroll Your iPhone

Enrolling your iPhone prepares it for corporate apps.



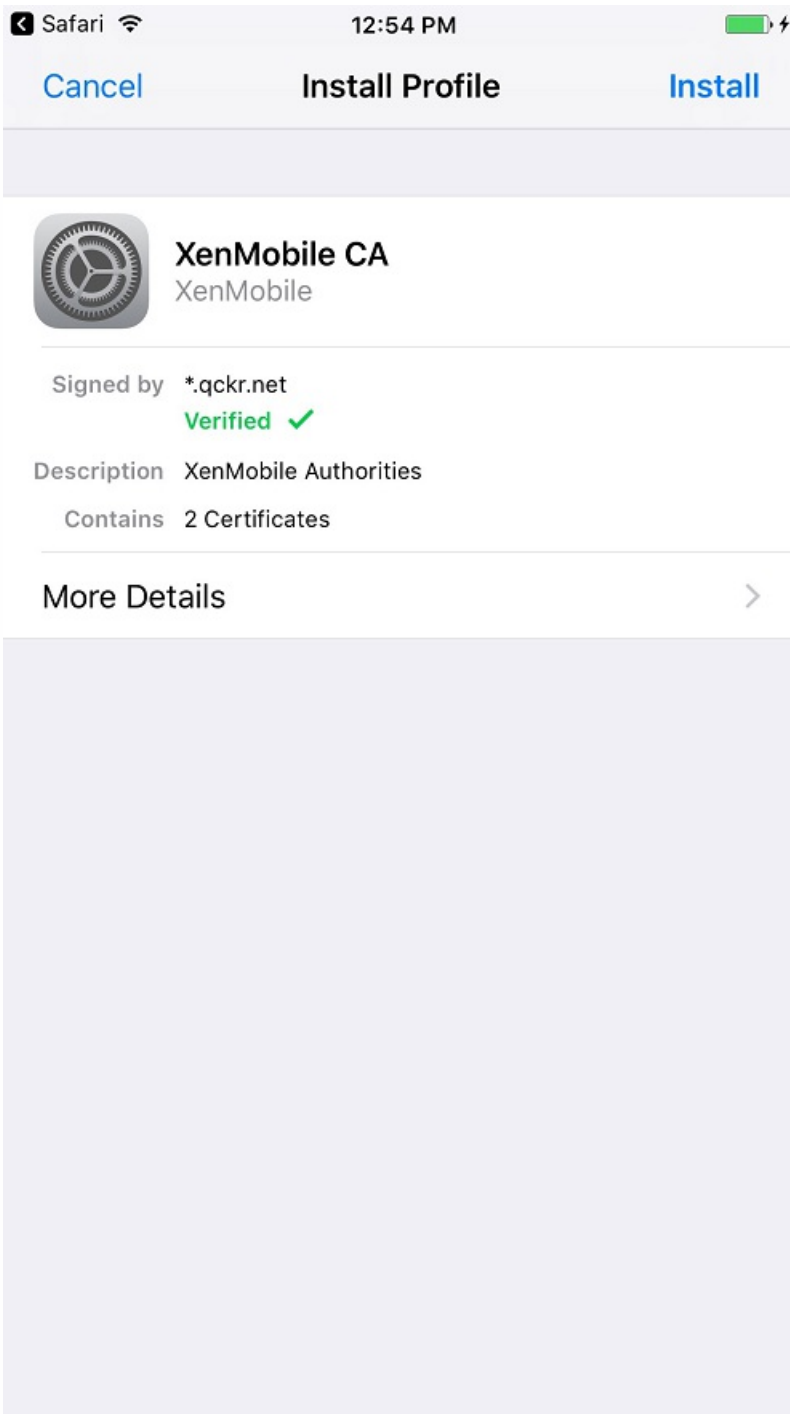

4. Users complete the enrollment steps in the same way as any other enrollment through Secure Hub.

Note: XenMobile doesn't support authentication through Azure AD for enrollment invitations. If you send users an enrollment invitation containing an enrollment URL, users authenticate through LDAP instead of Azure AD.

Derived credentials for iOS

Jun 19, 2017

Derived credentials provide strong authentication for mobile devices. The credentials, derived from a smart card, reside in a mobile device instead of the card. The smart card is either a Personal Identity Verification (PIV) card or Common Access Card (CAC).

The derived credentials are an enrollment certificate that contains the user identifier, such as UPN. XenMobile stores the credentials obtained from the credential provider in a secure vault on the device.

XenMobile can use derived credentials for iOS device enrollment. If configured for derived credentials, XenMobile doesn't support enrollment invitations or other enrollment modes for iOS devices. However, you can use the same XenMobile Server to enroll Android devices through enrollment invitations and other enrollment modes.

Requirements

- One of the following derived credential solutions:
 - Intercede 3.12
Citrix has validated that XenMobile works with the Intercede derived credential solution. The app name in the Apple App Store is MyID for Citrix.
Note: Users must install MyID for Citrix on their devices *before* enrolling in XenMobile.
- Other derived credential solutions
While it's likely that most other credential solutions are compatible with XenMobile, test the integration before deploying it to production.
- XenMobile Server 10.6 (minimum version)
 - Configured for Enterprise (XME) mode
 - Must have the root certificate of the authority that issues certificates to the Credentials Provider server. That setup enables XenMobile to accept the digitally signed certificates during enrollment. For information about adding the certificates, see [Certificates and authentication](#).
 - If the user email domain differs from the LDAP domain, include the email domain in the **Domain alias** setting in **Settings > LDAP**. For example, if the domain for email addresses is myID.com and the LDAP domain name is sample.com, set **Domain alias** to **sample.com, myID.com**.
 - You can't use derived credentials with shared devices.
- User identity certificates:
 - The username in the Subject alternative name field must be formatted as otherName, rfc822Name, or dNSName field of the SubjectAltName extension. Other fields are not supported. For more information about Subject alternative name, see the RFC, <https://www.ietf.org/rfc/rfc5280.txt>.
 - User identity in the Subject field in either Email or CN is not currently supported.
- NetScaler Gateway configured for certificate authentication or certificate plus security token authentication
For information about PKI configuration, see PKI entities.
- Secure Hub 10.6 (minimum version)
- XenMobile Apps 10.6 (minimum version)
 - Secure Mail doesn't use derived credentials and continues to work as before.
 - Use the same developer certificate to sign all apps in the Apple App Store.

Architecture

For enrollment, XenMobile Server connects to the components described in the "Requirements" section, as shown in the following diagram.

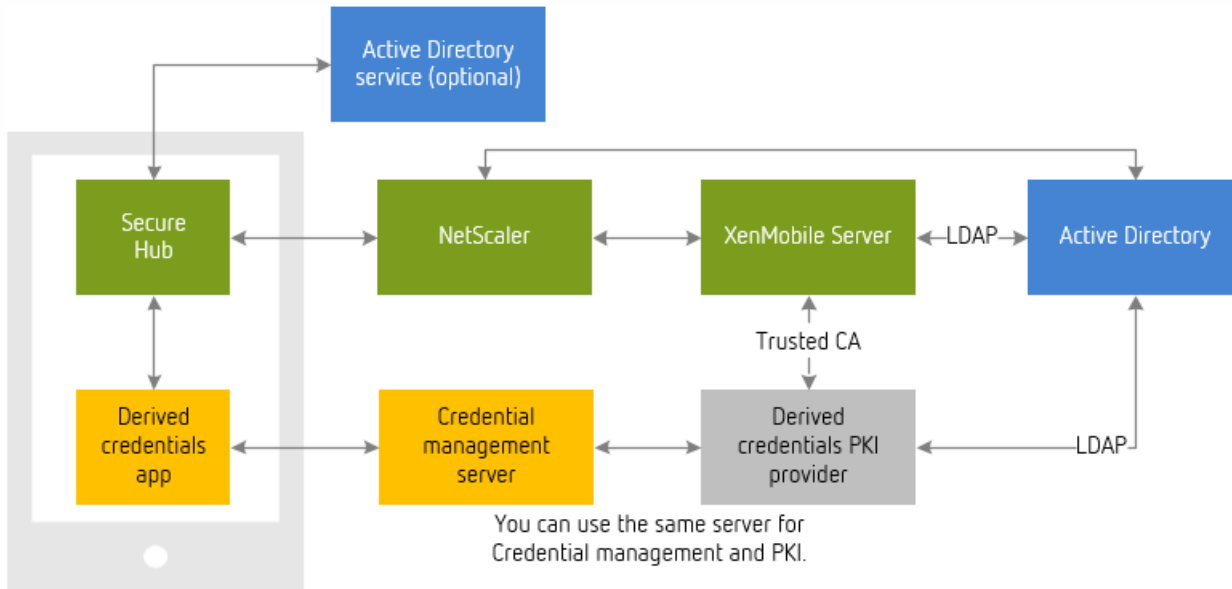

- During device enrollment, Secure Hub obtains certificates from the derived credentials app.
- The derived credentials app communicates with the credential management server during enrollment.
- You can use the same or different server for the credential management server and a third-party PKI provider.
- XenMobile Server connects to your third-party PKI server to obtain certificates.

After enrollment, the components connect as shown in the following diagram.

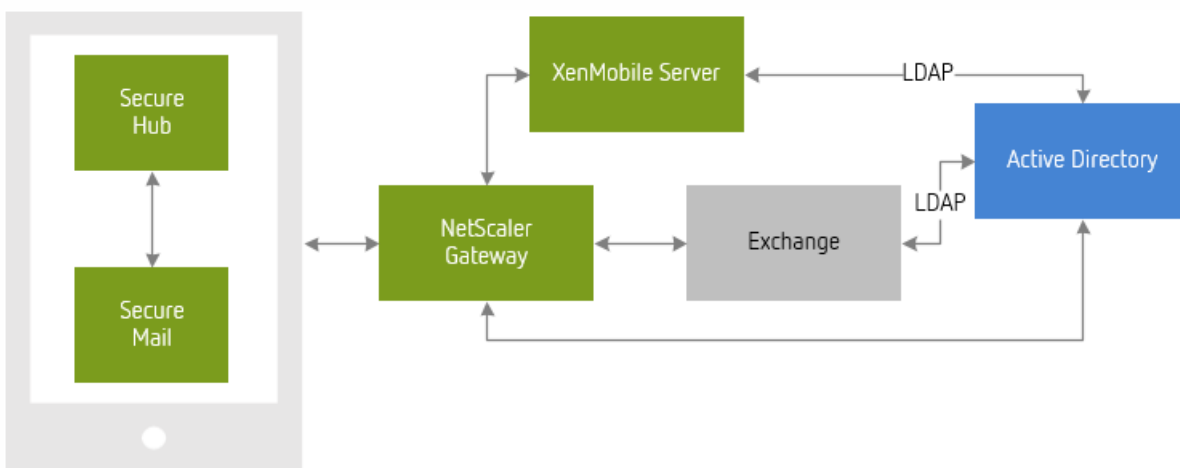

The following sections describe how to configure XenMobile with a derived credentials provider, enable derived credentials for enrollment, and manage devices that use derived credentials.

Enable derived credentials

By default, the XenMobile console doesn't include the **Settings > Derived Credentials** page. To enable the interface for derived credentials, go to **Settings > Server Properties**, add the server property **derived.credentials.enable**, and set it to **true**.

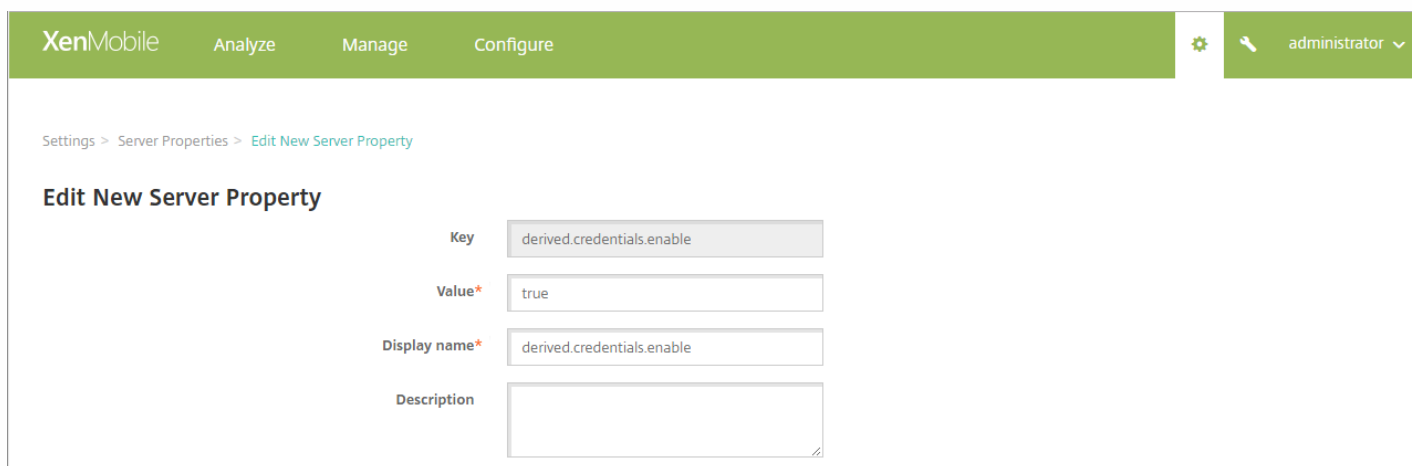

The screenshot shows the XenMobile console interface. The top navigation bar is green and contains the XenMobile logo, 'Analyze', 'Manage', and 'Configure' tabs. On the right, there is a gear icon, a magnifying glass icon, and a user profile dropdown labeled 'administrator'. Below the navigation bar, the breadcrumb trail reads 'Settings > Server Properties > Edit New Server Property'. The main content area is titled 'Edit New Server Property' and contains a form with the following fields:

Key	<input type="text" value="derived.credentials.enable"/>
Value*	<input type="text" value="true"/>
Display name*	<input type="text" value="derived.credentials.enable"/>
Description	<input type="text"/>

Configure derived credentials

These instructions assume that you have a working configuration for the derived credentials provider that you plan to integrate with XenMobile. You can then configure XenMobile to communicate with that server. You also choose a derived credentials CA certificate already added to XenMobile or import the certificate.

You can activate Online Certificate Status Protocol (OCSP) support for that CA certificate. For more information about OCSP, see "Discretionary CAs" in [PKI entities](#).

1. In the XenMobile console, go to **Settings > Derived Credentials for iOS**.

Settings > Derived Credentials for iOS

Derived Credentials for iOS

Configure a derived credentials provider to enable iOS users to enroll with a smart card.

Provider

Choose derived credentials provider* Intercede Other (tech preview)

App URL (iOS)* ⓘ

Optional parameters ⓘ

Name*	Value*	Add

Details

Issuer CA* ⓘ

CA Info
Name: dc-demo-WIN-V7749C6OETD-CA
Expire: 2022-01-26

User Identifier field* Subject name ⓘ Subject alternative name

User identifier type* ⓘ

OCSP

OCSP Check ⓘ

2. Under **Provider**:

- **Choose derived credentials provider.** Citrix validated that XenMobile works with **Intercede**. If you choose **Other** for the provider, test the integration before putting your server into production.
- **App URL (iOS):** If you choose **Intercede** as the provider, XenMobile fills in the **App URL**. If you choose **Other** as the provider, obtain the App URL from your derived credentials provider.

Note: If a device can't contact your provider, verify the App URL with the provider. You might need to change it.

- **Optional parameters:** Some derived credential providers might require that you provide parameters for the connection. For example, a vendor might require that you specify the URLs of a back-end server. Click **Add** to provide parameters.

3. Specify a certificate for derived credentials: If the certificate is already uploaded to XenMobile, choose that certificate from **Issuer CA**. Otherwise, click **Import** to add a certificate. The **Import Certificate** dialog box appears.
4. In the **Import Certificate** dialog box, click **Browse** to navigate to the certificate. Then click **Browse** to navigate to the private key file.

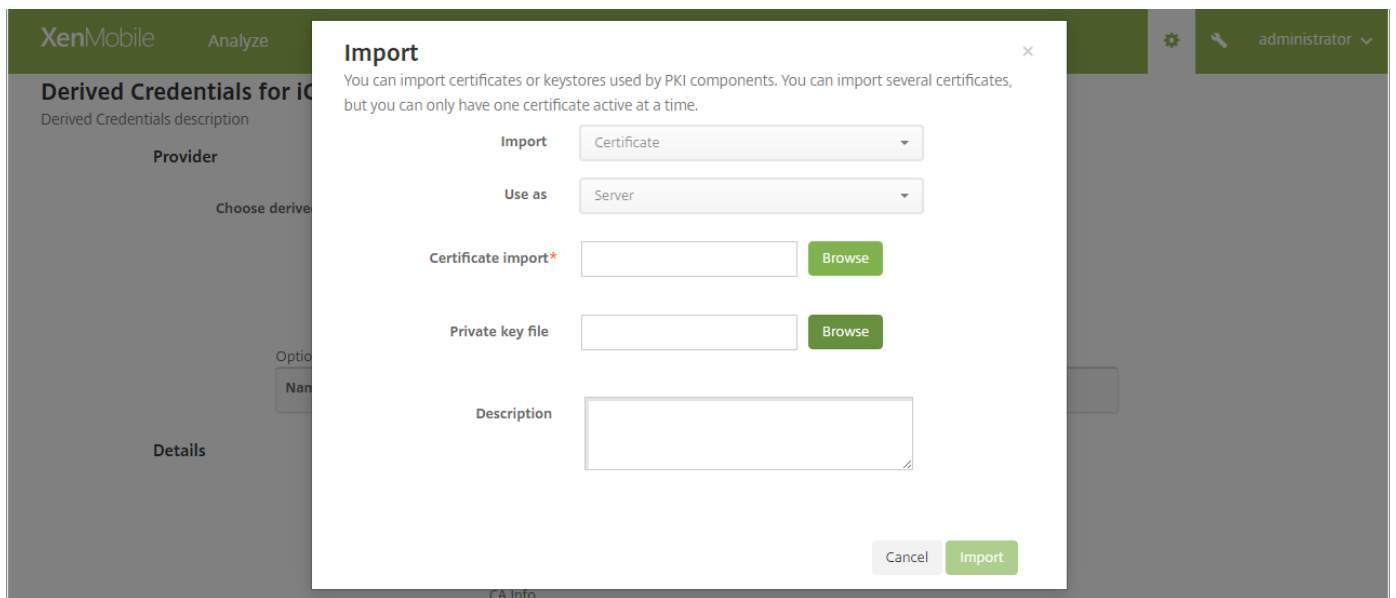

5. If you choose **Intercede** as the provider, XenMobile fills in the **User Identifier field** and the **User Identifier type**. For Intercede, the **User Identifier field** is **Subject alternative name**, and the **User Identifier type** is **userPrincipalName**. Contact other derived credential providers for their information and configure the settings.
6. You can optionally use an OCSP responder for certificate revocation checking. By default, OSP checking is off. To activate OCSP support for the CA certificate:
 - Set **OCSP check** to **ON**.

- Choose an option for **Use custom OCSP URL**. By default, XenMobile extracts the OCSP URL from the certificate (the **Use certificate definition for revocation** option). To specify a responder URL, click **Use custom** and type the URL.
- **Responder CA**: From **Responder CA**, choose a certificate. Or, click **Import**, and then use the **Import Certificate** dialog box to locate the certificate.

7. Click **Save**. The **Derived Credentials** dialog box appears.

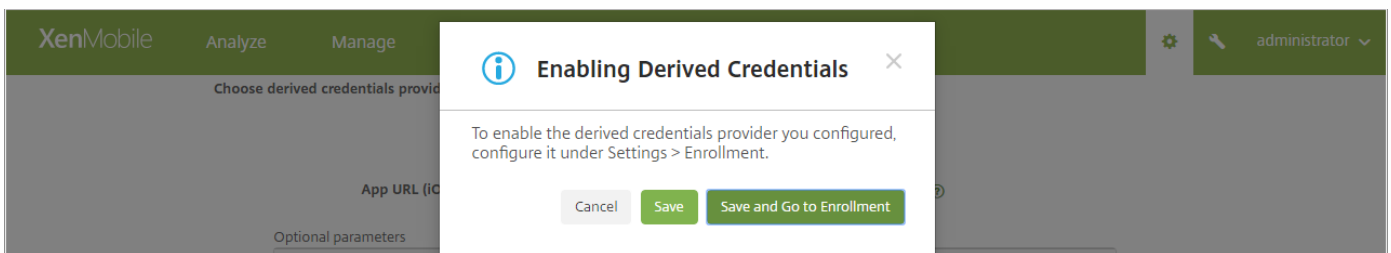

- To enable the derived credentials configuration, click **Save**. To use derived credentials, you must also configure enrollment settings.
- To enable the derived credentials configuration and then go immediately to **Settings > Enrollment**, click **Save and Go to Enrollment**.

8. To enable derived credentials for enrollment: On the **Settings > Enrollment** page, under **Advanced Enrollment**, select

Derived Credentials (iOS only) and then click **Enable**.

The screenshot shows the XenMobile configuration interface. At the top, there is a navigation bar with 'XenMobile', 'Analyze', 'Manage', and 'Configure'. On the right, there is a user profile for 'administrator'. Below the navigation bar, the breadcrumb 'Settings > Enrollment' is visible. The main heading is 'Enrollment', with a sub-heading 'Enrollment for other platforms' and a warning message: 'Enrollment for other platforms will be available here. X'. Below this is a table of enrollment methods:

<input type="checkbox"/>	Name	Enabled	Default	Self Help Portal	Expire after	Attempts	PIN length	PIN type	Templates
<input type="checkbox"/>	User name + Password	✓	✓						
<input type="checkbox"/>	High Security	✓			1 day(s)	3	8	numeric	
<input type="checkbox"/>	Invitation URL	✓			1 day(s)				
<input type="checkbox"/>	Invitation URL + PIN	✓			1 day(s)	3	8	numeric	
<input type="checkbox"/>	Invitation URL + Password	✓			1 day(s)	3			
<input type="checkbox"/>	Two Factor	✓			1 day(s)	3	8	numeric	
<input type="checkbox"/>	User name + PIN	✓			1 day(s)	3	8	numeric	

Showing 1 - 7 of 7 items

Below the table is the 'Advanced Enrollment' section with a table:

<input type="checkbox"/>	Name	Enabled	Default
<input type="checkbox"/>	Derived Credentials (iOS only)	✓	✓

9. A confirmation dialog box appears. To enable derived credentials, select the check box, and click **Enable**.

The dialog box has a title bar with an orange warning icon and the text 'Enable Derived Credentials for iOS.' and a close button (X). The main content area contains the following text:

New Enrollments for iOS
All new iOS enrollments must use derived credentials.

Other platforms:
This does not effect new device enrollments on Mac, Windows 10, and Android.

Are you sure you want to enable derived credentials for iOS?

Yes. This will be the default for iOS enrollments.

At the bottom right, there are two buttons: 'Cancel' and 'Enable'.

To edit options for derived credentials enrollment, go to **Settings > Enrollment**, select **Derived Credentials (iOS only)**, and then click **Edit**.

After you enable derived credentials: In the Devices Enrollment report, the column **Enrollment mode** shows **derived_credentials**.

For enrollment steps when using derived credentials, see [iOS devices using derived credentials](#).

Log messages for derived credentials

Log messages during Secure Hub communication with XenMobile Server indicate success or failure, as follows.

Messages from XenMobile Server (SessionCreate SUCCESS)

2017-05-11T23:23:28.537+0000 | D88973753C718B23 | INFO | http-nio-10080-exec-47 | com.sparus.nps.ios.agent.V9AgentUtils | Derived Credential: User extracted from certificate: XXXXXXX@XMTEST.NET

2017-05-11T23:23:28.728+0000 | D88973753C718B23 | INFO | http-nio-10080-exec-47 | com.sparus.nps.ios.agent.V9AgentUtils | Derived Credential: Using user 'XXXXXX@XMTEST.NET' from cert and converted to XXXXXXX with certid 60000001a95b7fecbbbf2821dd000000001a9

2017-05-11T23:23:28.883+0000 | D88973753C718B23 | INFO | http-nio-10080-exec-47 | com.citrix.cg.bo.spring.impl.InternalUserServiceImpl | Input params for addUser. UserName 'XXXXXXX@auster.ctx' and Domain Name 'auster.ctx'

2017-05-11T23:23:29.94+0000 | D88973753C718B23 | INFO | http-nio-10080-exec-47 | com.citrix.xms.oca.imil.service.impl.GroupServiceImpl | No.of groups:0 retrieved by UserID:40

2017-05-11T23:23:29.95+0000 | D88973753C718B23 | WARN | http-nio-10080-exec-47 | com.sparus.nps.ldap.LdapCredentialHandlerImpl | No groups found for user XXXXXXX@auster.ctx'

2017-05-11T23:23:34.244+0000 | 21829910a6438ef5 | INFO | http-nio-10080-exec-60 | com.sparus.nps.ios.agent.V7ContextBuilder | No matching identity found in request from 172.16.1.57 to /zdm/ios/agent.jsessionid=D88973753C718B23ADDEA26B46E5FBB2

2017-05-11T23:23:59.118+0000 | 21829910a6438ef5 | INFO | http-nio-10080-exec-52 | com.sparus.nps.ios.enroll.ProfileServiceServlet | New enrollment initiated for serialNumber=CCQLQNKPFMJF, imei=null, uid=4a621749b64f7d915849ebcef3ded9cf7f460406, meid=null

Messages from XenMobile Server (SessionCreate FAIL)

2017-05-11T23:06:46.168+0000 | 40DA582380D50C72 | INFO | http-nio-10080-exec-42 | com.sparus.nps.ios.agent.V9AgentUtils | Derived Credential: User extracted from certificate: XXXXXXX@XMTEST.NET

2017-05-11T23:06:46.233+0000 | 40DA582380D50C72 | WARN | http-nio-10080-exec-42 | com.citrix.cg.util.CGUtil | No default Domain found redirecting to 'local' domain.

2017-05-11T23:06:46.253+0000 | 40DA582380D50C72 | WARN | http-nio-10080-exec-42 | com.citrix.cg.util.CGUtil | local domain. Directory service not managed for IDP local

2017-05-11T23:06:46.253+0000 | 40DA582380D50C72 | ERROR | http-nio-10080-exec-42 |

com.sparus.nps.ios.agent.V9AgentUtils | dc exception

com.citrix.xmls.oa.imil.exception.OperationFailedException: Could not log on. Incorrect user name or password

Messages from Secure Hub (SessionCreate SUCCESS)

start request with id 6 and value (redacted) https://*****/zdm/ios/agent?action=sessioncreate&h=dc

Handling the client cert challenge for h=dc

Cred length is 3405

Passing the credentials in DC client cert challenge

Credentials parsed successfully

received challenge NSURLAuthenticationMethodServerTrust

request with id 6 succeeded with httpResponse code 200

Messages from Secure Hub (SessionCreate FAIL)

start request with id 6 and value (redacted) https://*****/zdm/ios/agent?action=sessioncreate&h=dc

Handling the client cert challenge for h=dc

Item found.

Cred length is 3434

Passing the credentials in DC client cert challenge

Credentials parsed successfully

request with id 6 failed with httpResponse code 500

Upgrade

Jun 19, 2017

Important

Before you upgrade to XenMobile 10.6 (on-premises)

1. If the virtual machine running the XenMobile Server to be upgraded has less than 4 GB of RAM, increase the RAM to at least 4 GB. Keep in mind that the recommended minimum RAM is 8 GB for production environments.
2. For upgrades from XenMobile 10.4 or earlier: Make a note about your configurations for the Passcode and Restrictions device policies for Windows tablets. Those policies are no longer based on WMI. As a result, the upgrade removes the existing configurations. After the upgrade, reconfigure the Passcode and Restrictions device policies for Windows tablets.
3. If you have the deprecated Enterprise Data Protection device policy configured, delete the policy before upgrading.

Citrix publishes new versions or important updates of XenMobile to Citrix.com. At the same time, a notice is sent to the contact on record for each customer.

You have these options for upgrading XenMobile:

- **To upgrade from XenMobile 10.4 or 10.5 to XenMobile 10.6.** Use the **Release Management** page in the XenMobile console. You do not use the Upgrade Tool to upgrade XenMobile 10 installations.
- **To upgrade from XenMobile 10.3.6 to XenMobile 10.6.** Use the **Release Management** page in the XenMobile console to upgrade in the following sequence. You do not use the Upgrade Tool for these installations.
 - Upgrade from XenMobile 10.3.6 to XenMobile 10.5.
 - Upgrade from XenMobile 10.5 to XenMobile 10.6.
- **To upgrade from XenMobile 10 or 10.1 to XenMobile 10.6.** Use the **Release Management** page in the XenMobile console to upgrade in the following sequence. You do not use the Upgrade Tool for these installations.
 - Upgrade from XenMobile 10 or 10.1 to XenMobile 10.3.5.
 - Upgrade from XenMobile 10.3.5 to XenMobile 10.4.
 - Upgrade from XenMobile 10.4 to XenMobile 10.6.
- **To upgrade from XenMobile 9.0 to the latest XenMobile release.**
Use the XenMobile Upgrade Tool that is built in to the latest XenMobile release. See the articles in this section for details.

The Upgrade Tool supports all XenMobile 9 editions: MDM, App, and Enterprise. For fixed and known issues, see [Fixed issues](#) and [Known issues](#). The older Upgrade Tool is no longer available from Citrix.com.

This article details the versions to use for upgrades, how to use the **Release Management** page, and how to upgrade clustered XenMobile deployments.

Upgrade path summary

Current XenMobile Server version	Release number	Upgrade to	Release number	Upgrade path	Update location
XenMobile Server 9 with App Controller Rolling Patch 9 installed	9.0.0_97106	XenMobile Server 10.6	10.6.0	XenMobile Server 9 upgrade to XenMobile Server 10.6	Download the App Controller rolling patch prerequisite. <ul style="list-style-type: none"> The Upgrade Tool for XenMobile 10.6 is built into XenMobile Server. For more information, see Upgrade Tool prerequisites.
XenMobile Server 10 or XenMobile 10.1	10.1.0.63030	XenMobile Server 10.3.5	10.3.5	XenMobile 10 or XenMobile 10.1 upgrade to XenMobile 10.3.5	Download
XenMobile Server 10.3.5	10.3.5	XenMobile Server 10.4	10.4.0.116	XenMobile 10.3.5 upgrade to XenMobile 10.4	Download
XenMobile Server 10.4	10.4.0.116	XenMobile Server 10.6	10.6.0	XenMobile 10.4 upgrade to XenMobile 10.6	Download
XenMobile Server 10.5	10.5.x	XenMobile Server 10.6	10.6.0	XenMobile 10.5 upgrade to XenMobile 10.6	Download

To upgrade using the Release Management page

Use the **Release Management** page to upgrade from supported XenMobile 10 versions (indicated in the preceding table) to the latest version of XenMobile Server.

Important

Before you install a XenMobile update, use the functionality in your virtual machine (VM) to take a snapshot of your system. Also, back up your system configuration database. If you experience issues during an upgrade, complete backups enable you to recover.

Prerequisites:

- Review the [System Requirements](#).

If you have a clustered deployment, see the instructions at the end of this article.

- Log on to your account on the Citrix website and download the XenMobile Upgrade (.bin) file to an appropriate location.
- In the XenMobile console, click the gear icon in the upper-right corner of the console. The **Settings** page appears.

3. Click **Release Management**. The **Release Management** page appears.

The screenshot shows the XenMobile interface with a green header containing 'XenMobile', 'Analyze', 'Manage', and 'Configure'. On the right, there are icons for settings and a user profile labeled 'admin'. Below the header, the breadcrumb 'Settings > Release Management' is visible. The main heading is 'Release Management', followed by a sub-heading: 'View the current installed release, as well as a list of all updates, patches, and upgrades to the XenMobile server up to the current date and time.' Below this, a table lists the current release details:

Current Release	10.30.000
Name	Release 10.30.000
Description	Software release build 10.30.000
Install date and time	Oct 26, 2015 12:41 PM

Below the table is an 'Updates' section with a circular refresh icon and the text 'Update'. Underneath is a table with columns: Name, Release, Description, Install date and time, and Type. The table is currently empty, with the text 'No results found.' below it.

4. Under **Updates**, click **Update**. The **Update** dialog box appears.

The screenshot shows a dialog box titled 'Update' with a close button (X) in the top right corner. The text inside reads: 'It is recommended that you create a backup before installing updates.' Below this text is a form with a label 'Upgrade or patch file*' followed by an empty text input field and a green 'Browse' button. At the bottom of the dialog, there are two buttons: a grey 'Cancel' button and a green 'Update' button.

5. Select the XenMobile upgrade file you downloaded from Citrix.com by clicking **Browse** and navigating to the file location.

6. Click **Update** and then if prompted, restart XenMobile.

If for some reason the update cannot be completed successfully, an error message appears indicating the problem. The system is reverted to its state previous to the update attempt.

Note: After an upgrade, XenMobile requires a restart. Use the XenMobile CLI to restart XenMobile Server. It's important that you clear your browser cache after the system restarts.

To upgrade clustered XenMobile deployments

Important

Before you install a XenMobile update, use the functionality in your virtual machine (VM) to take a snapshot of your system. Also, back up your system configuration database. If you experience issues during an upgrade, complete backups enable you to recover.

If your system is configured in cluster mode, follow these steps to update each node from a XenMobile 10 release:

1. Upload the .bin file on all nodes from **Settings > Release Management**.
2. Shut down all the nodes from the **System Menu** in the CLI.
3. Bring up one node, from the **System Menu** in the CLI, and check that the service is running.
4. Bring up other nodes one after the other.

If XenMobile can't complete the update successfully, an error message appears indicating the problem. XenMobile then reverts the system to its state previous to the update attempt.

Upgrade Tool prerequisites

Jul 17, 2017

To upgrade from XenMobile 9.0 to the latest version of XenMobile, you use the XenMobile built-in Upgrade Tool.

The Upgrade Tool supports:

- iOS and Android devices enrolled in all XenMobile Server Modes (ENT, MAM, MDM)
- Windows phones and tablets enrolled in MDM mode
- Windows phones enrolled in Enterprise mode
- Windows CE devices in MDM mode

If Multi-Tenant Console (MTC) is enabled on XenMobile 9.0, you can migrate MTC to a stand-alone deployment of the latest version of XenMobile. XenMobile 10 does not support MTC, so you must manage these upgraded instances on an individual basis. After you complete the prerequisites in this article, see [Upgrade the MTC tenant server to XenMobile](#).

The latest version of XenMobile supports NetScaler Gateway versions 12.0, 11.1.x, 11.0.x, and 10.5.x.

The Upgrade Tool built in to XenMobile also supports NetScaler Gateway version 10.1.x. Citrix doesn't support NetScaler Gateway 10.1 for use with the latest version of XenMobile. However, you can upgrade a NetScaler Gateway 10.1 deployment using the Upgrade Tool built in to XenMobile. After that, Citrix recommends that you upgrade NetScaler Gateway to the latest supported version.

Important

The upgrade process is complex. Before starting an upgrade, be sure to review the [Known issues](#), plan your upgrade, and complete all prerequisites, as described in this article. In addition, this [blog](#) includes prerequisite checklists that can help you plan your upgrade.

After you run the Upgrade Tool, be sure you complete all post-requisites.

If you don't complete a prerequisite, the upgrade can fail. You must then configure a new instance of the latest version of XenMobile in the command-line console and start the Upgrade Tool again.

Plan your upgrade

Citrix recommends that you upgrade in the following stages.

1. Do a test drive in a staging environment, completing all prerequisite and Upgrade Tool steps. Citrix recommends that you do an upgrade test drive first to get a feel for how the process works and what you can expect to see after you do a full production upgrade. A test drive upgrade tests the upgrade of your configuration data, not user data.

In NetScaler (minimum version NetScaler 10.5), Citrix recommends that you use the NetScaler for XenMobile Wizard to set up a fresh NetScaler with NetScaler Gateway and NetScaler load balancing virtual servers.

2. Verify that the test drive correctly upgraded your configuration data, such as LDAP, policies, and apps. Verify test devices.
3. Do a production upgrade in your production environment and go live. Plan for downtime while running the upgrade.

About test drives and production upgrades

With the XenMobile Upgrade Tool, you first test the upgrade and then perform the full production upgrade.

When you choose Test Drive:

The Upgrade Tool does an upgrade test drive with production configuration data to compare XenMobile 9.0 and the latest version of XenMobile without affecting your production environment. The test drive upgrade tests only configuration data; it does not test device data (in the case of XenMobile Enterprise Edition deployments) or user data.

The results of an upgrade test drive are for testing only. You cannot upgrade a test drive deployment. Instead, you must begin again for a production upgrade. An upgrade test drive works with any XenMobile 9.0 edition.

When you choose Upgrade:

The Upgrade Tool at first copies all configuration, device, and user data from XenMobile 9.0 to a new instance of the latest version of XenMobile with the same fully qualified domain name (FQDN). Everything in XenMobile 9.0 remains intact until you move the new XenMobile server instance into production.

When you log on to the console for the new XenMobile server instance after the upgrade, you see all the user and device data that the upgrade moved from XenMobile 9.0.

What the Upgrade Tool does not do

The following information isn't upgraded to the latest version of XenMobile when you use the Upgrade Tool:

- Licensing information.
- Reports data.
- Server group policies and associated deployments (not supported in the latest version of XenMobile).
- Managed Service Provider (MSP) group.
- Policies and packages related to Windows 8.0.
- Deployment packages not in use; for example, when no users or groups are assigned to a deployment package.
- Any other configuration or user data as described in the upgrade log file.
- CXM Web (replaced by Citrix Secure Web).
- DLP policies (replaced by Citrix Sharefile).
- Custom Active Directory attributes.
- If you have configured multiple branding policies in XenMobile 9.0, the branding policy is not upgraded. Later versions of XenMobile support one branding policy; you have to leave one branding policy in XenMobile 9.0 to successfully upgrade to the latest version of XenMobile.
- Any settings in the auth.jsp file in XenMobile 9.0 that are used to restrict access to the console. Console access restrictions in the latest version of XenMobile are firewall settings that you can configure in the command-line interface.
- Sys log server configurations.
- Form-fill connectors configured on XenMobile 9.0 (not supported in later versions of XenMobile).

XenMobile changes

- The Upgrade Tool doesn't upgrade Active Directory users who are assigned to local groups. You can subsequently assign Active Directory users to local groups.
- XenMobile 10 doesn't support nested local groups. An upgrade from XenMobile 9 flattens the local groups hierarchy.
- Deployment packages in Device Manager are referred to as delivery groups in XenMobile, as shown in the following figure. For more information, see [Deploy resources](#).

XenMobile Analyze Manage **Configure** ⚙️ 🔍 admin ▾

Device Policies Apps Actions ShareFile Enrollment Profiles **Delivery Groups**

Delivery Groups [Show filter](#) 🔍

[Add](#) | [Export](#)

<input type="checkbox"/>	Status	Name	Last Updated	Disabled	▾
<input type="checkbox"/>		AllUsers			
<input type="checkbox"/>		Domain users	Jun 13 2016 5:10 PM		
<input type="checkbox"/>		Sales	Apr 13 2016 12:50 PM		

Inside the delivery group, you can view the policies, actions, and apps required for the group of users who require the resources.

XenMobile Analyze Manage **Configure** ⚙️ 🔍 admin ▾

Device Policies Apps Actions ShareFile Enrollment Profiles **Delivery Groups**

Delivery Group

- 1 Delivery Group Info
- 2 User
- 3 Resource (optional)
- Policies
- Apps
- Actions
- ShareFile
- Enrollment Profile
- 4 Summary

Delivery Group Information ✕

Enter a name for the delivery group and any information that will help you keep track of it later.

Name

Description

Upgrade workflow for XenMobile 9.0 to the latest version of XenMobile

The following figures illustrate the basic steps you take to upgrade from XenMobile 9.0.

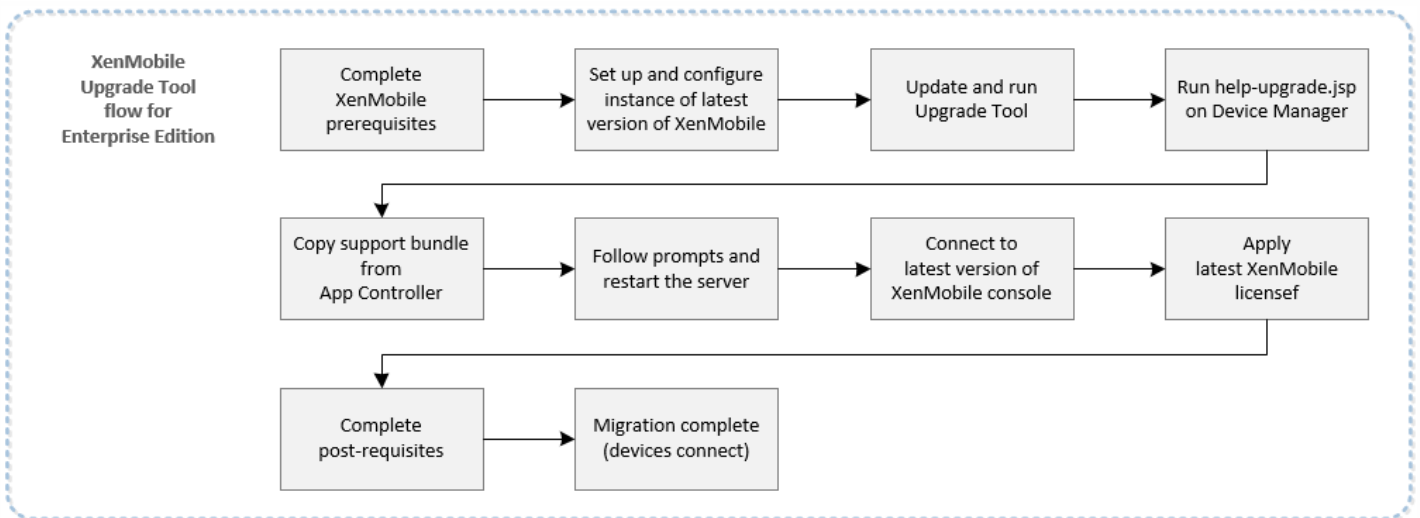
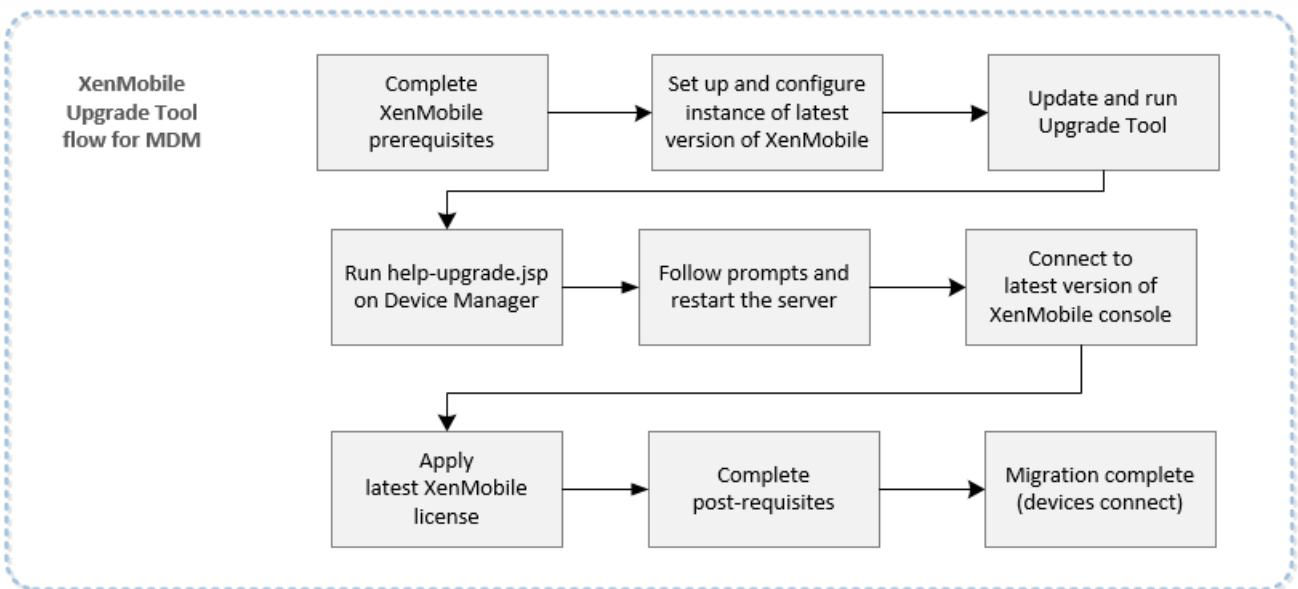
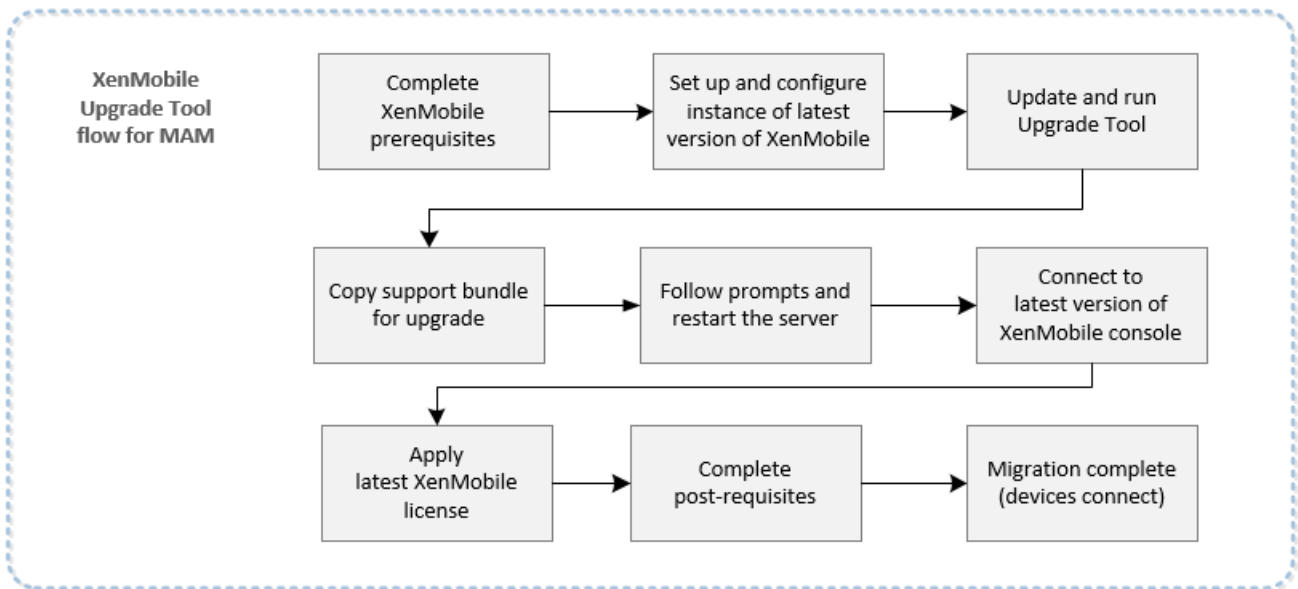

Prerequisites for Windows phones in Enterprise mode

Citrix recommends the following steps for upgrading a XenMobile 9.0 Enterprise environment, with Windows Phones enrolled in Enterprise mode and using Worx Home 9.x, to the latest version of XenMobile.

1. Upgrade Worx Home on Device Manager to Worx Home 10.2 or later and then deploy Worx Home 10.2.
2. Manually uninstall Worx Home 9.x from user devices.
3. Instruct users to go to the Download Hub on their phone to install Worx Home 10.2 or later, which you deployed from Device Manager.
4. After you complete the prerequisites described in this article, upgrade to the latest version of XenMobile as described in [Enable and run the XenMobile Upgrade Tool](#).
5. Make NetScaler changes for devices to connect back, as described in [Upgrade Tool post-requisites](#).

Required App Controller patch

Download XenMobile 9.0 App Controller Rolling Patch 9 from <https://support.citrix.com/article/CTX218552>.

In the App Controller management console, go to **Settings > Release Management**. Click **Update** and then select the patch file you downloaded. Click **Upload** and then restart App Controller.

Custom store names in XenMobile 9

Before you upgrade XenMobile 9 to the latest version of XenMobile, you must change a custom store name back to its default value so that enrolled Windows devices continue to work after the upgrade. For more information, see <http://support.citrix.com/article/CTX214553>.

In a MAM or Enterprise mode upgrade, if the store name has been changed to from the default Store on App Controller, restore the name back to the default setting of **Store** before generating a support bundle for the upgrade.

Beacons [Edit](#)

Store name:

*

Store

Default store view:

Category

System and port requirements

For the required versions of related components such as Citrix License Server, see [System requirements](#) and its sub-articles.

- **NetScaler:** Before you upgrade NetScaler, be sure to save a copy of your Netscaler configuration file (ns.conf). Current Netscaler releases include an easy-to-use quick deployment utility, the NetScaler for XenMobile wizard, that guides you through the steps to integrate NetScaler and XenMobile. For more information, see [Configuring Settings for Your XenMobile Environment](#) and [FAQ: XenMobile 10 and NetScaler 10.5 Integration](#).
- **Firewall Ports:** Open firewall ports for the new XenMobile Server IP similar to the ports opened for the XenMobile 9.0 IP

server. For XenMobile port requirements, see [Port requirements](#).

- **LDAP Server:** Make sure that the new XenMobile Server connects to one or more LDAP servers. You must have an active route to LDAP servers after you upgrade, when you restart the server.

Database migration

To migrate using an existing database, the database service account password in the old and new infrastructures must match.

The following table lists the possible database migration options. For system requirements, see [XenMobile Database Requirements](#).

From XenMobile 9.0	To the latest version of XenMobile	
Enterprise Edition		
App Controller	MDM	
Local PostgreSQL	Local PostgreSQL	Local PostgreSQL
Local PostgreSQL	MS SQL	MS SQL
Local PostgreSQL	Remote PostgreSQL	Remote PostgreSQL
App Edition		
Local PostgreSQL		Local PostgreSQL
Local PostgreSQL		Remote PostgreSQL
Local PostgreSQL		MS SQL
MDM Edition		
Local PostgreSQL		Local PostgreSQL
MS SQL		MS SQL
Remote PostgreSQL		Remote PostgreSQL

During the database migration process, XenMobile needs the ability to access the database solution implemented on XenMobile 9.0 Device Manager. For example, the following ports must be open:

- For Microsoft SQL Server, the default port is 1433.
- For PostgreSQL, the default port is 5432.

To allow remote connections to PostgreSQL, you must complete the following steps:

1. Open the file `pg_hba.conf` and then locate the following line:

```
host all all 127.0.0.1/32 md5
```

2. To allow all IP addresses, change the line to:

```
host all all 0.0.0.0/0 md5
```

Alternatively, add another host entry to allow connections to the XenMobile server IP address:

```
host all all 10.x.x.x/32 md5
```

3. Save the file.

4. Stop and start the service.

5. Open the `postgresql.conf` file and then locate the following line:

```
#listen_addresses = 'localhost'
```

6. Change the line to:

```
listen_addresses = '*'
```

7. Stop and start the PostgreSQL service to apply the changes.

If the database solution has a custom port assigned, you must ensure that the port is allowed and open in the firewall protecting XenMobile 9.0 Device Manager. Doing so enables the new instance of XenMobile to connect to the database and migrate the required information.

Deployment package names with special characters

Deployment package names in XenMobile 9.0 that contain special characters (!, \$, (), #, % , +, *, ~, ?, |, {}, and []) upgrade, however you can't edit the delivery groups in new instance of XenMobile after the upgrade. In addition, local users and local groups created in XenMobile 9.0 that contain an open square bracket ([]) cause problems in new instance of XenMobile with creating enrollment invitations. Before an upgrade, remove all special characters from deployment package names as well as open square brackets from local user and local group names.

External SSL certificate

External SSL certificates must meet the conditions outlined in the Citrix Support article [How to Configure an External SSL Certificate](#). Be sure to review your `pki.xml` before starting the upgrade to ensure that the SSL certificate meets those conditions.

Export XenMobile 9.0 server certificate

If you are upgrading a XenMobile 9.0 Enterprise Edition deployment, you must export the App Controller server certificate. Later, when you are handling the upgrade post-requisites, you must import the server certificate into NetScaler Gateway. Follow these steps to export the server certificate:

1. Log on to the XenMobile 9.0 App Controller and click **Certificates**.
2. In the certificate list, click the server certificate you want to export and then click **Export**.

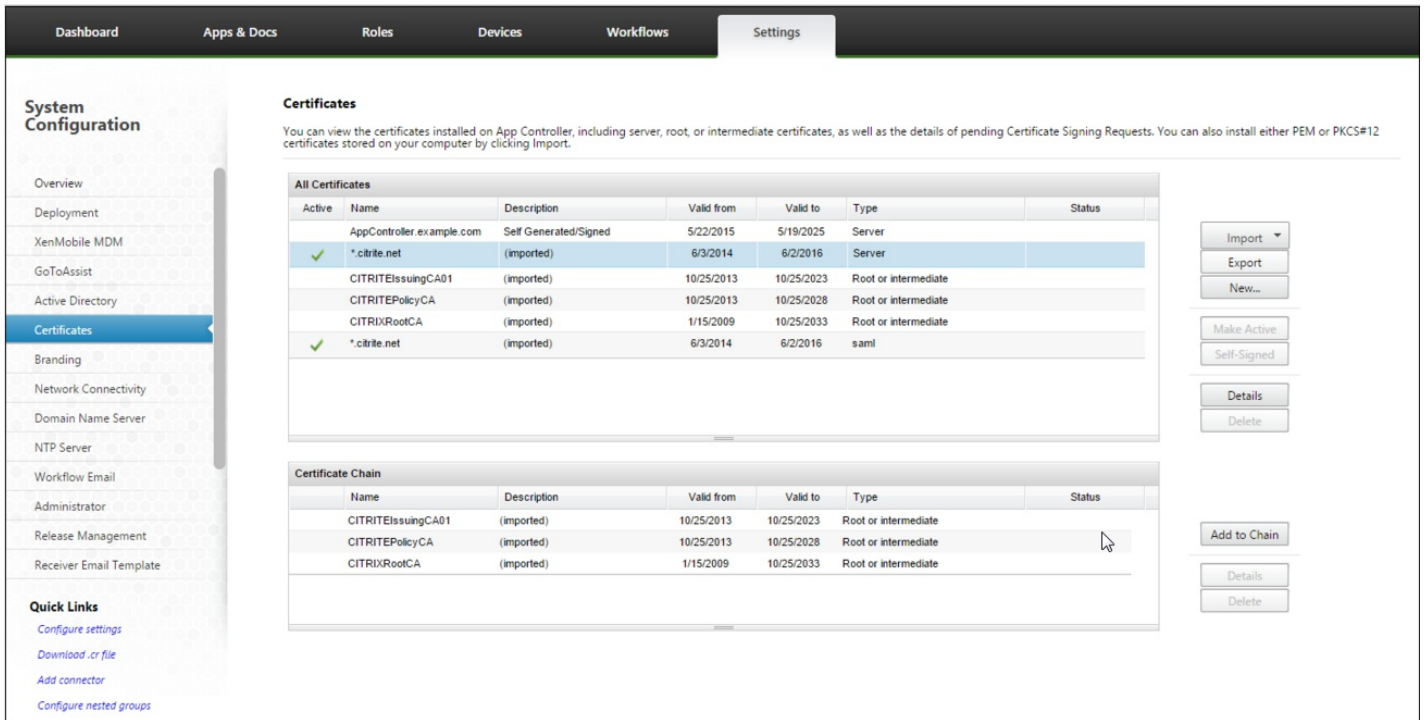

3. In the **Export Certificate** dialog box, type your certificate password in both fields and then click **OK**.

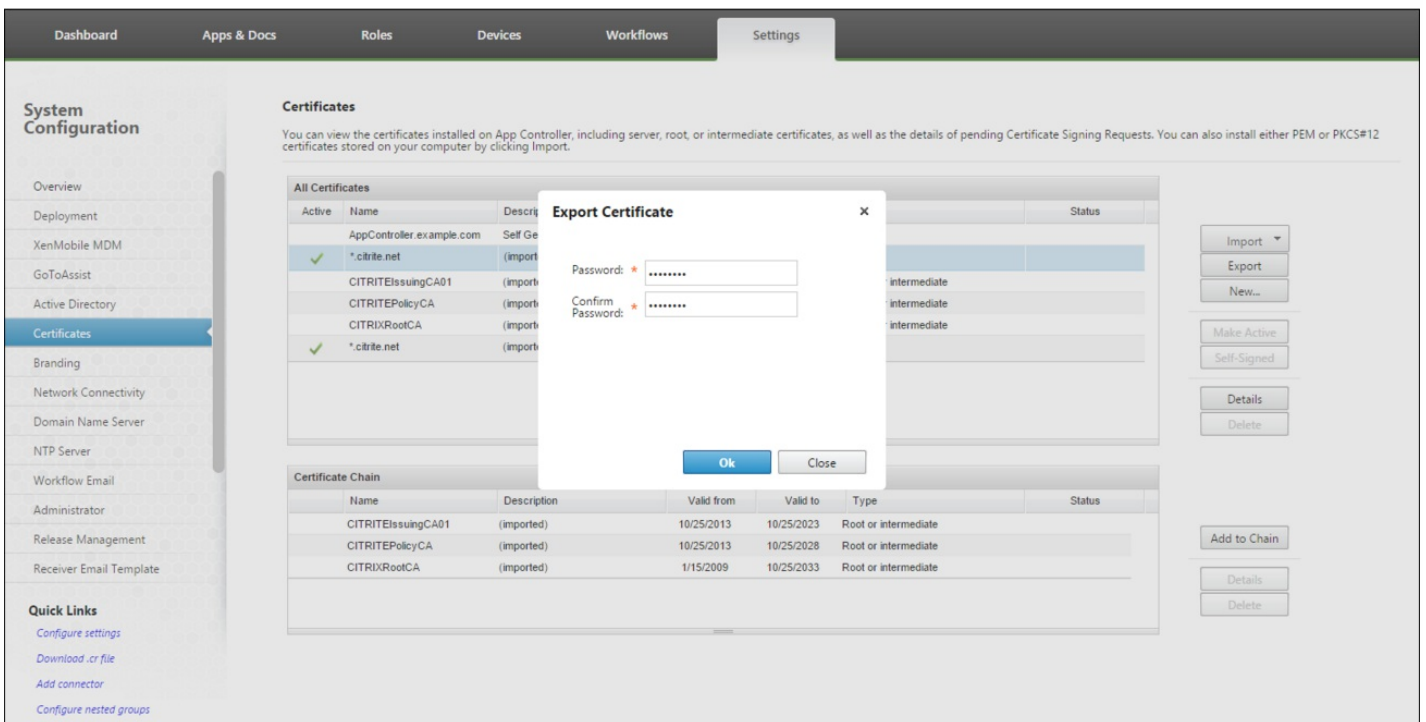

Server for uploading the encrypted support bundle

Prepare a server where you can upload the encrypted support bundle from the XenMobile command-line interface using either the File Transfer Protocol (FTP) or Secure Copy Protocol (SCP).

Enable and run the XenMobile Upgrade Tool

Jul 17, 2017

If your XenMobile 9 environment meets the following prerequisites, follow the steps in this section before proceeding with the upgrade.

- XenMobile 9 MDM Edition or Enterprise Edition has an external SQL Server database.
- SQL Server database runs on a non-default named instance.
- SQL Server named instance listens on a static or dynamic TCP port. You can confirm this prerequisite by looking at the IP addresses of the TCP/IP protocol of the named instance as shown in the following figures.

Note

Citrix recommends that the SQL server database instance always runs on a static port, because the XenMobile server needs continuing access to the database. This connection generally traverses through a firewall. As a result, you must open the appropriate port in the firewall. Therefore, ensure that the database instance is running on a static port.

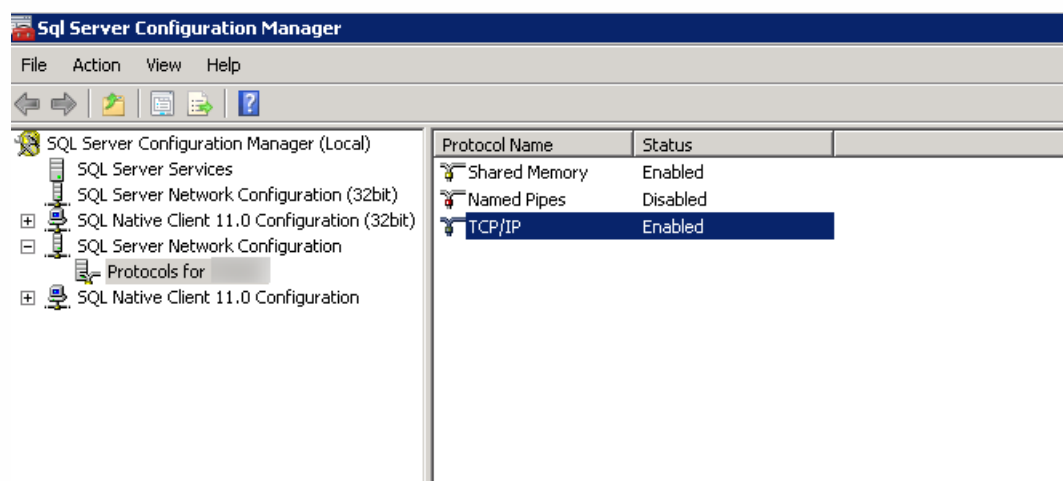

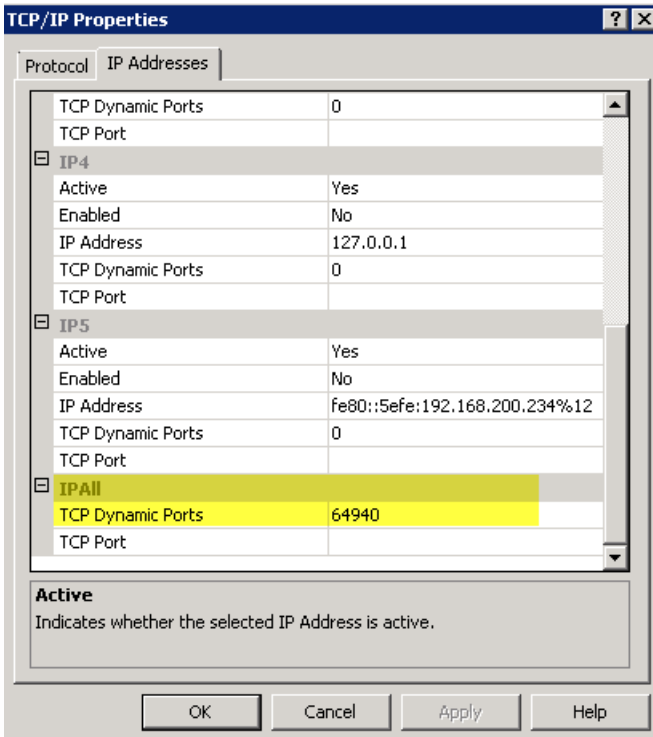

Pre-upgrade steps

1. Go to the Device Manager installation directory and open the ew-config.properties file. This file is available in tomcat\webapps\zdm\WEB-INF\classes.

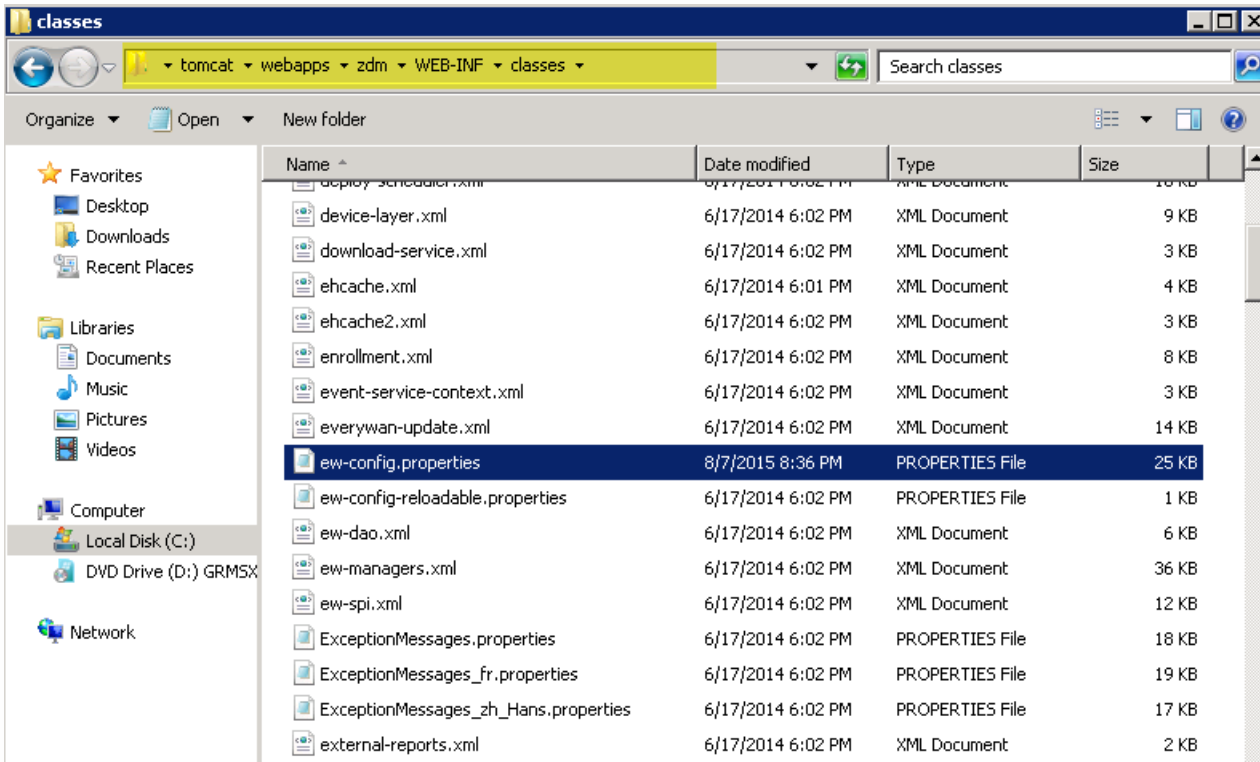

2. In the ew-config.properties file, search for the following URLs in the DATASOURCE Configuration section:

pooled.datasource.url=jdbc:jtds:sqlserver://<SQLServer_FQDN>/<DB_Name>;instance=<Instance_Name>

audit.datasource.url=jdbc:jtds:sqlserver://<SQLServer_FQDN>/<DB_Name>;instance=<Instance_Name>

```
ew-config.properties
18 # For Microsoft SQL server url1: pooled.datasource.url=jdbc:jtds:sqlserver://localhost:1433/everywan
19 # For Microsoft SQL server url1 with a named instance (url2): pooled.datasource.url=jdbc:jtds:sqlserver://localhost/everywan;instance=SQLExpress
20 # For Microsoft SQL server url2 with a Windows authentication (NTLM): pooled.datasource.url=jdbc:jtds:sqlserver://localhost/everywan;instance=SQLExpress;domain=sparus-
21 # Oracle url: pooled.datasource.url=jdbc:oracle:thin:everywan/everywan@localhost:1521/everywan
22 pooled.datasource.url=jdbc:jtds:sqlserver://ah-234.net/-11aug;instance=
23 # Pooled datasource host name
24 pooled.datasource.hostname=ah-234.net
25 # Pooled datasource database
26 pooled.datasource.database=-11aug
27 # Pooled datasource user
28 pooled.datasource.user=sa
29 # Pooled datasource password
30 # For Microsoft SQL server (10 characters minimum) ex: pooled.datasource.password=everywan01
31 pooled.datasource.password=(aes) ==
32
33 # No pooled datasource driver
34 #no.pooled.datasource.driver=org.postgresql.Driver
35 # No pooled datasource url
36 #no.pooled.datasource.url=jdbc:postgresql://localhost:5432/everywan
37 # No pooled datasource user
38 #no.pooled.datasource.user=everywan
39 # No pooled datasource password
40 #no.pooled.datasource.password=everywan
41
42 # Audit datasource driver
43 audit.datasource.driver=net.sourceforge.jtds.jdbc.Driver
44 # Audit datasource url
45 audit.datasource.url=jdbc:jtds:sqlserver://ah-234.net/-11aug;instance=
46 # Audit datasource host name
47 audit.datasource.hostname=ah-234.net
48 # Audit datasource database
49 audit.datasource.database=-11aug
50 # Audit datasource user
51 audit.datasource.user=sa
52 # Audit datasource password
```

3. Remove the instance name in the preceding URLs, then add the port and SQL Server FQDN. In this case, 64940 is the required port.

pooled.datasource.url=jdbc:jtds:sqlserver:// <SQLServer_FQDN>:64940/<DB_Name>

audit.datasource.url=jdbc:jtds:sqlserver:// <SQLServer_FQDN>:64940/<DB_Name>

Note

Citrix recommends that you make a backup, copy, or note of the changes you make in the ew-config.properties file. This information is helpful in case the upgrade fails.

```

18 # For Microsoft SQL server url1: pooled.datasource.url=jdbc:jtds:sqlserver://localhost:1433/everywan
19 # For Microsoft SQL server url1 with a named instance (url2): pooled.datasource.url=jdbc:jtds:sqlserver://localhost/instance=SQLExpress
20 # For Microsoft SQL server url2 with a Windows authentication (NTLM): pooled.datasource.url=jdbc:jtds:sqlserver://localhost/instance=SQLExpress;domain=sparus-s
21 # Oracle url: pooled.datasource.url=jdbc:oracle:thin:everywan/everywan@localhost:1521/everywan
22 pooled.datasource.url=jdbc:jtds:sqlserver://ah-234. net: -llaug
23 # Pooled datasource host name
24 pooled.datasource.hostname=ah-234. .net
25 # Pooled datasource database
26 pooled.datasource.database=-llaug
27 # Pooled datasource user
28 pooled.datasource.user=sa
29 # Pooled datasource password
30 # For Microsoft SQL server (10 characters minimum) ex: pooled.datasource.password=everywan01
31 pooled.datasource.password={aes} ==
32
33 # No pooled datasource driver
34 #no.pooled.datasource.driver=org.postgresql.Driver
35 # No pooled datasource url
36 #no.pooled.datasource.url=jdbc:postgresql://localhost:5432/everywan
37 # No pooled datasource user
38 #no.pooled.datasource.user=everywan
39 # No pooled datasource password
40 #no.pooled.datasource.password=everywan
41
42 # Audit datasource driver
43 audit.datasource.driver=net.sourceforge.jtds.jdbc.Driver
44 # Audit datasource url
45 audit.datasource.url=jdbc:jtds:sqlserver:// -inc.net: -llaug
46 # Audit datasource host name
47 audit.datasource.hostname=ah-234. .net
48 # Audit datasource database
49 audit.datasource.database=-llaug
50 # Audit datasource user
51 audit.datasource.user=sa
52 # Audit datasource password

```

4. Restart the Device Manager service. Refresh the device connections after the Device Manager instance restarts.

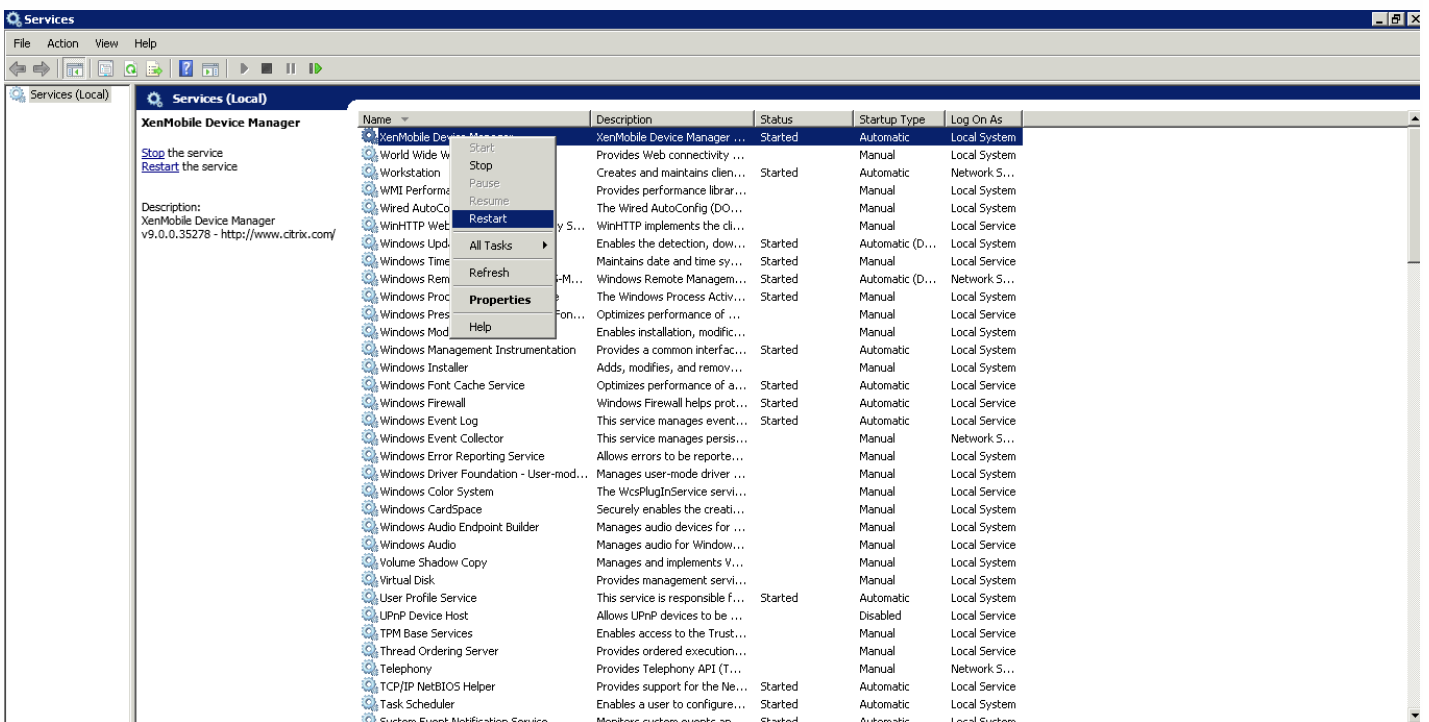

5. Determine if the new XenMobile 10.x server must also work with named SQL instance. If so, identify the port on which the named instance is running. If the port is a dynamic port, Citrix recommends that you convert the port to a static port. Later, when you reach the following portion of the database setup during the upgrade, configure the static port on the new XenMobile server.

```
Type: [mi]
Use SSL (y/n) [n]:
Server [10.207.86.64]:
Port [1433]:
Username [sa]:
Password:
Database name [RC]:

Reboot is required to save the changes.
Do you want to proceed? (y/n) [y]: █
```

You can now proceed with the upgrade.

To upgrade clustered XenMobile deployments

If your system is configured in cluster mode:

1. Shut down all nodes other than the one you plan to upgrade first. To shut down a node, use **Settings** in the command-line interface.
2. Upgrade the node that's still running, as described in the next section, "To enable and run the Upgrade Tool."
3. After you've ensured that the first upgrade has upgraded as expected, rejoin each of the remaining nodes, one at a time. To rejoin:
 - a. Restart the node.
 - b. Do not upgrade the node if prompted.
 - c. Join the node to the cluster database.

XenMobile will automatically upgrade a node after you rejoin it to the cluster.

4. Perform all post-requisite tasks on each node after you rejoin it to the cluster.

To enable and run the Upgrade Tool

Enable the Upgrade Tool through the command-line interface (CLI) when you first install the latest version of XenMobile.

Important

If you want to take a snapshot of your system, first complete the initial configuration of the latest version of XenMobile and use the Upgrade Tool.

1. In the CLI, type your administrator user name and password and then enter your network settings.
2. Type **y** to commit the settings.

```
*****
*      Citrix XenMobile      *
*      (in First Time Use mode) *
*****

Welcome to the XenMobile First Time Use wizard. This wizard guides you through the
initial configuration of XenMobile. Accept options offered by pressing Enter/
Return or type your own response and then press Enter/Return.

Command prompt window administrator account:
This is the user name and password you use when logging on to XenMobile at the c
ommand prompt.
Username: admin
New password:
Re-enter new password:

Network settings:
IP address []: 10.207.87.35
Netmask []: 255.255.254.0
Default gateway []: 10.207.86.1
Primary DNS server []: 10.207.86.50
Secondary DNS server (optional) []: 10.207.86.51

Commit settings (y/n) [y]:
```

3. Type **y** to upgrade.

Note

If you do not select **y** here, you must configure a new instance of the latest version of XenMobile in the command-line console. Then, start the Upgrade Tool again.

4. Complete these settings:

- Citrix recommends typing **y** to generate a random passphrase. XenMobile uses the passphrase as part of the protection of the encryption keys which secure your sensitive data. XenMobile uses a hash of the passphrase, stored in the server file system, to retrieve the keys during the encryption and decryption of data. The passphrase isn't viewable.
- Optionally, enable FIPS.
- Type your database connection information.

5. Type **y** to commit the settings.

```

Commit settings (y/n) [y]:
Applying network settings...

Upgrade:
Upgrade from previous release (y/n) [n]: y

Encryption passphrase:
Generate a random passphrase to secure the server data (y/n) [y]:

Federal Information Processing Standard (FIPS) mode:
Enable (y/n) [n]:

Database connection:
Local or remote (l/r) [r]:
Type (mi=Microsoft SQL, p=PostgreSQL) [mi]:
Use SSL (y/n) [n]:
Server []: sql01.xmlab.net
Port [1433]:
Username [sa]: xmsadmin
Password:
Database name [DB_service]: migdemo

Commit settings (y/n) [y]:

```

XenMobile initializes the database.

```

Checking database status...
Database does not exist.
Initializing database...

```

6. Select whether to enable clustered servers. Type the XenMobile fully qualified domain name (FQDN). Note the following:

- For XenMobile Enterprise Edition deployments, the FQDN is the same as the XenMobile 9.0 MDM FQDN.
- For MAM deployments, the FQDN is the same as the XenMobile 9.0 App Controller FQDN.
- For MDM deployments, the FQDN is the same as the XenMobile 9.0 Device Manager FQDN.

Important

The FQDN for the 9.0 environment and for the new environment must match.

```

Cluster:
Please press y to enable cluster? [y/n]: y
To enable realtime communication between cluster members please open port 80 u
sing Firewall menu option in CLI menu, once the system configuration is complete
.

Xenmobile Server FQDN:
Hostname []: migdemo.xs.citrix.com

Commit settings (y/n) [y]:
Applying fqdn settings...

```

7. Type **y** to commit the settings.

8. Set communication ports.

```
Communication ports:
  HTTP [80]:
  HTTPS with certificate authentication [443]:
  HTTPS with no certificate authentication [8443]:
  HTTPS for management [4443]:

Commit settings (y/n) [y]:
```

9. Type **y** to commit the settings.

10. Select whether to use the same password for all certificates and type the password to be used for certificates.

11. Type **y** to commit the settings.

```
Applying port listener configuration...

The wizard will now generate an internal Public Key Infrastructure (PKI):
- A root certificate
- An intermediate certificate to issue device certificates during enrollment
- An intermediate certificate to issue an SSL certificate
- An SSL certificate for your connectors
- A Node Identification certificate for cluster node client auth
Do you want to use the same password for all the certificates of the PKI [y]:
New password:
Re-enter new password:

Commit settings (y/n) [y]:
Generating SAML signing certificate...
Generating server and client certificates...

XenMobile console administrator account:
This is the user name and password you use when logging on to the XenMobile console through a web browser.
Username [administrator]:
```

12. Type the user name and password for the XenMobile console administrator.

13. Type **y** to commit the settings.

XenMobile enables the one-time-only Upgrade Tool.

```
Re-enter new password:

Commit settings (y/n) [y]: y
Creating console administrator...
Applying firewall settings ...
Writing iptables configuration...
Restarting iptables...

Initial system configuration complete!
Stopping configuration app... [ OK ]
Starting configuration app...
  this may take a few seconds.....
  application started [ OK ]
Stopping main app... [ OK ]
Starting main app...
  not ready to start yet [ OK ]

To complete the upgrade process, from a web browser, go to the following
location and log on with your command prompt credentials:
  https://10.207.87.35/uw/

Starting monitoring... [ OK ]

migdemo.xs.citrix.com login: |
```

14. Access the Upgrade Tool on a web browser through <https://<XenMobile-Server-IPAddress>/uw/> and log in using the credentials you specified using the CLI.

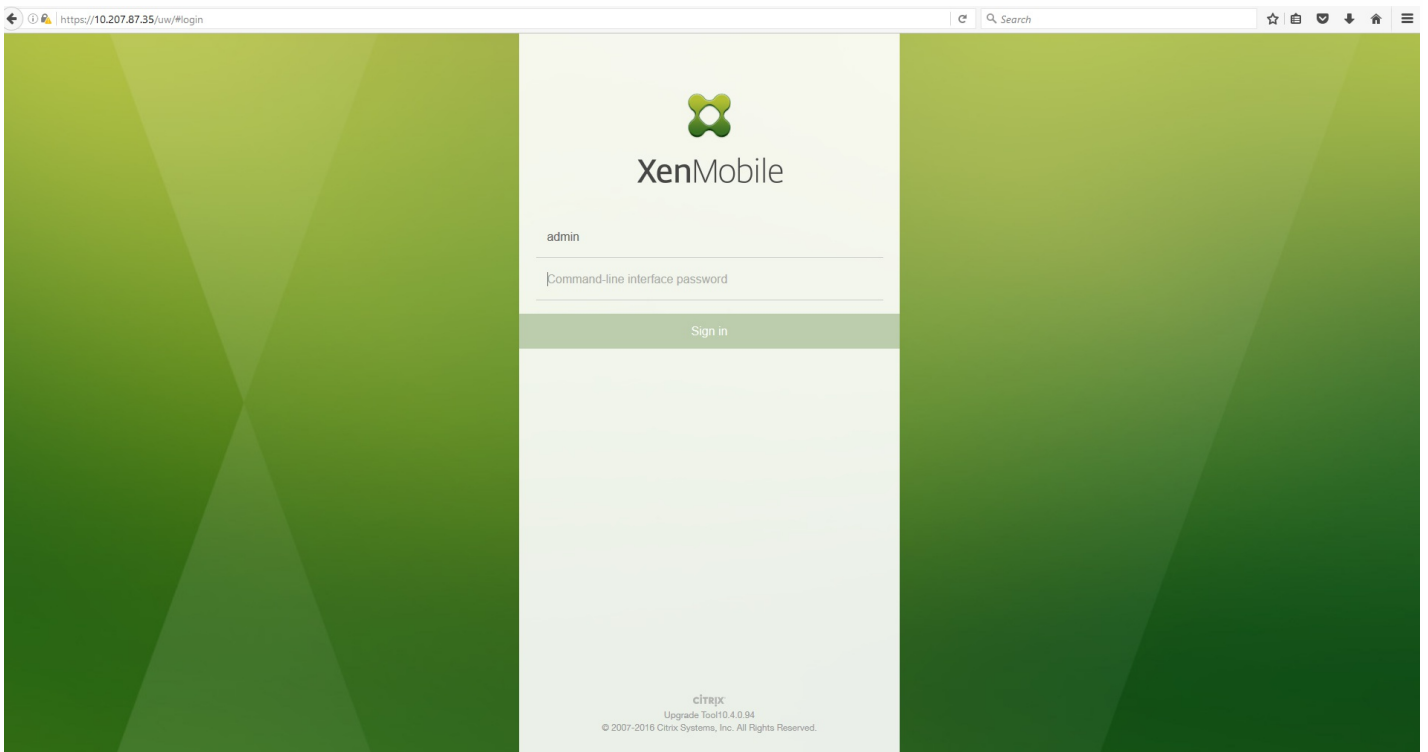

15. You can now choose between a test drive and a production upgrade. These instructions are for a production upgrade. In the **Upgrading XenMobile** page, click **Upgrade**.

Upgrading XenMobile

XenMobile 9.0 → XenMobile

Do you want to do a test drive upgrade?

- > Only configuration data (device policies, apps, actions, delivery groups) is upgraded.
- > Device and user data is not upgraded.
- > Your current deployment keeps running with no downtime as you upgrade. You can make configuration changes with no effect on users and devices.

[Test Drive](#)

Do you want to do a production upgrade?

- > All data (configuration, devices, users) is upgraded.
- > MDM users do not need to re-enroll or reinstall apps.
- > Your current deployment will be down for a while. The time needed for an upgrade depends on the size of the data set.
- > Citrix recommends that you shut down your current XenMobile environment to ensure data consistency while upgrading.

[Upgrade](#)

16. In the **Edition to Upgrade** page, select your edition. The example screen below shows Enterprise edition selected.

XenMobile
Upgrade
admin CITRIX

Production Upgrade

Edition to Upgrade

- 1 Edition to Upgrade
- 2 Upgrade Source
- Device Manager Data
- App Controller
- 3 Upgrade Progress
- 4 Upgrade Summary
- 5 Next Steps

XenMobile 9.0 edition to be upgraded:

Enterprise
 MDM
 MAM

Choose this option if you are a XenMobile Enterprise customer. The Upgrade Tool prompts you for information about your existing XenMobile Device Manager and App Controller. The tool then collects the existing configuration, as well as user and device state information, and upgrades your server to XenMobile 10.4. For upgrade instructions, refer to Upgrading XenMobile.

[Cancel](#)
[Next >](#)

17. Click **Next**.

If you are upgrading an Enterprise or MDM edition, the **Device Manager** page appears. Follow steps 18 through 22 to complete this page.

If you are upgrading a MAM edition, skip to step 23 to complete the **App Controller** page.

18. Collect the files required to migrate your existing XenMobile 9.0 Device Manager data. During this process, you get access to the database URL and user name that you then copy to the **Device Manager** page.

- a. Click the link in step 1 of the **Device Manager** page and save the downloaded help-upgrade.zip file.
- b. Extract the help-upgrade.jsp file to <MDM-Install-Path>\tomcat\webapps\zdm on your existing XenMobile 9.0 Device Manager.

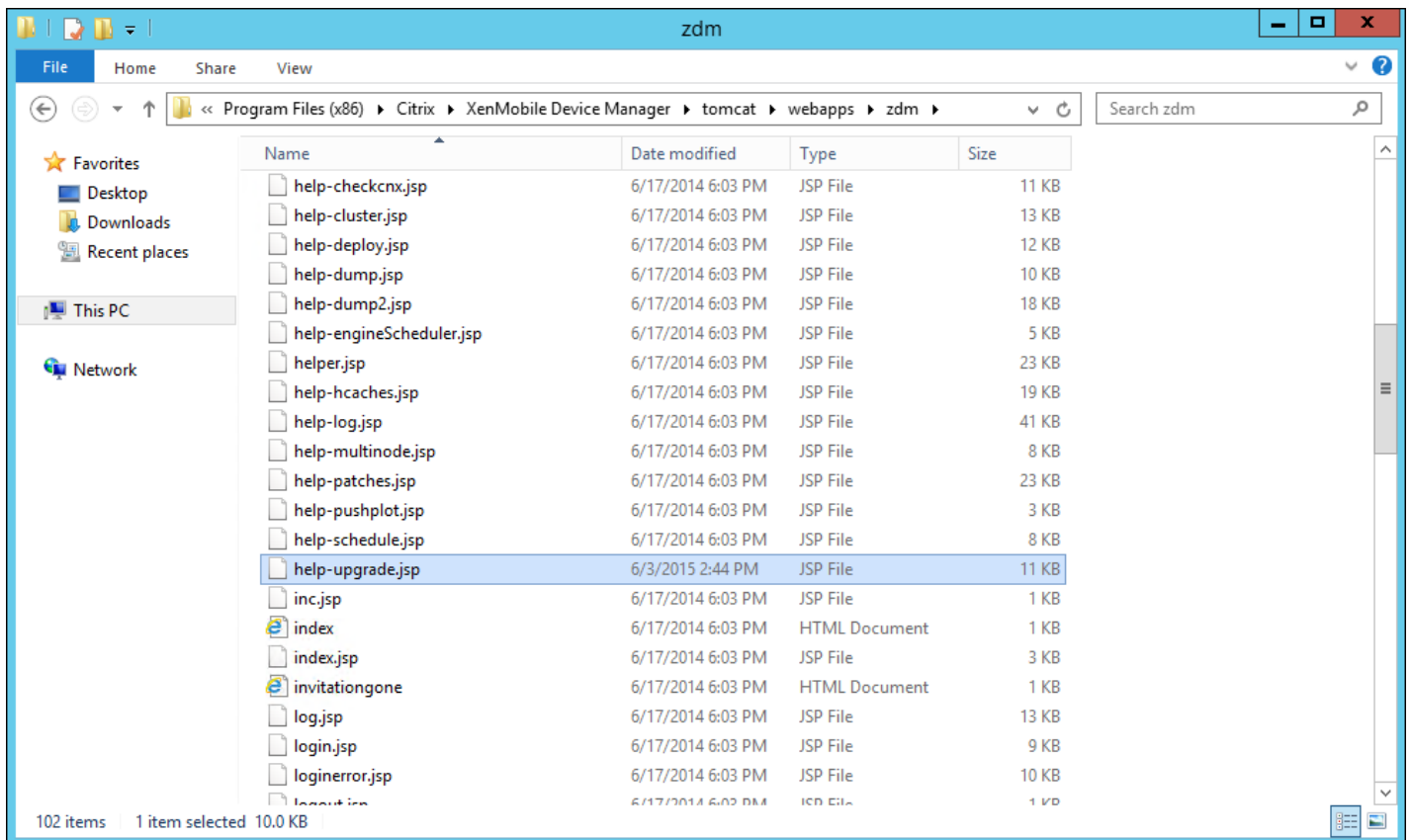

- c. In a browser window, log on to the XenMobile 9.0 server.
- d. In a separate browser tab, enter this URL to open the **XenMobile MDM Upgrade Helper** page: <https://localhost/zdm/help-upgrade.jsp>. That page includes a zip of all XenMobile 9.0 files that are needed for the upgrade. The zip file is stored in the server database from where it is extracted.
- e. Click **Zip it** and then follow the on-screen steps to collect the files needed for the upgrade.

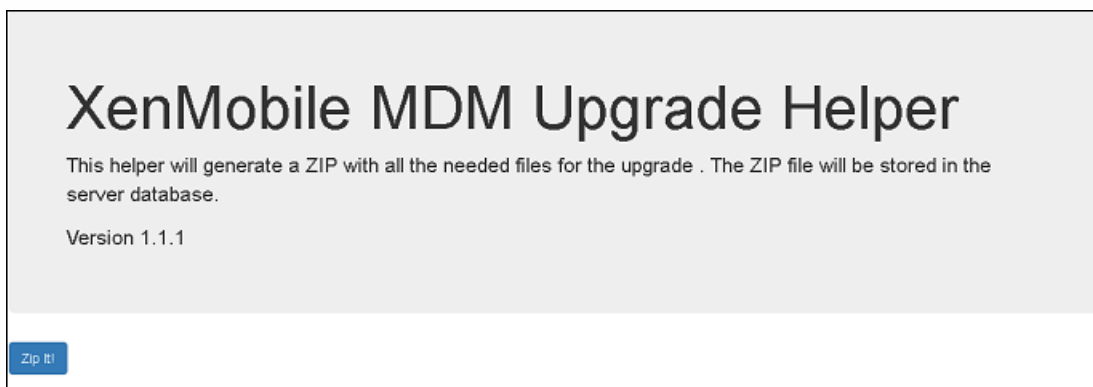

19. Under **Result**, copy the URL and paste it in the **Database URL** field in the Upgrade Tool **Device Manager** page. Then copy the user name and copy it to the **Device Manager** page.

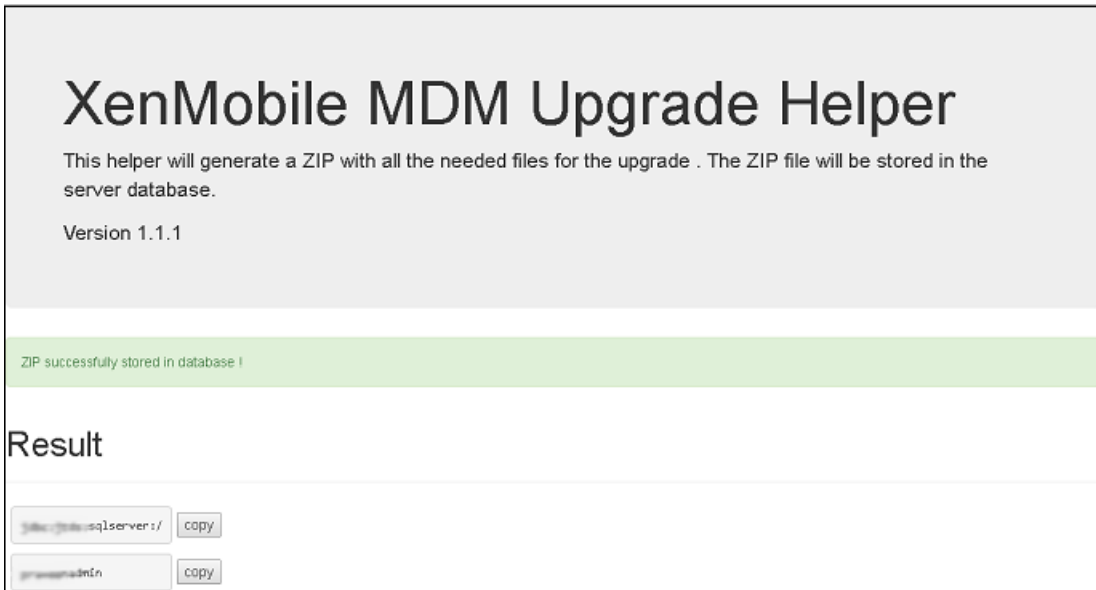

20. In the Upgrade Tool:

- a. Enter the password and then click **Validate Connection**.
- b. Enter the password for each certificate and then click **Validate Password**.

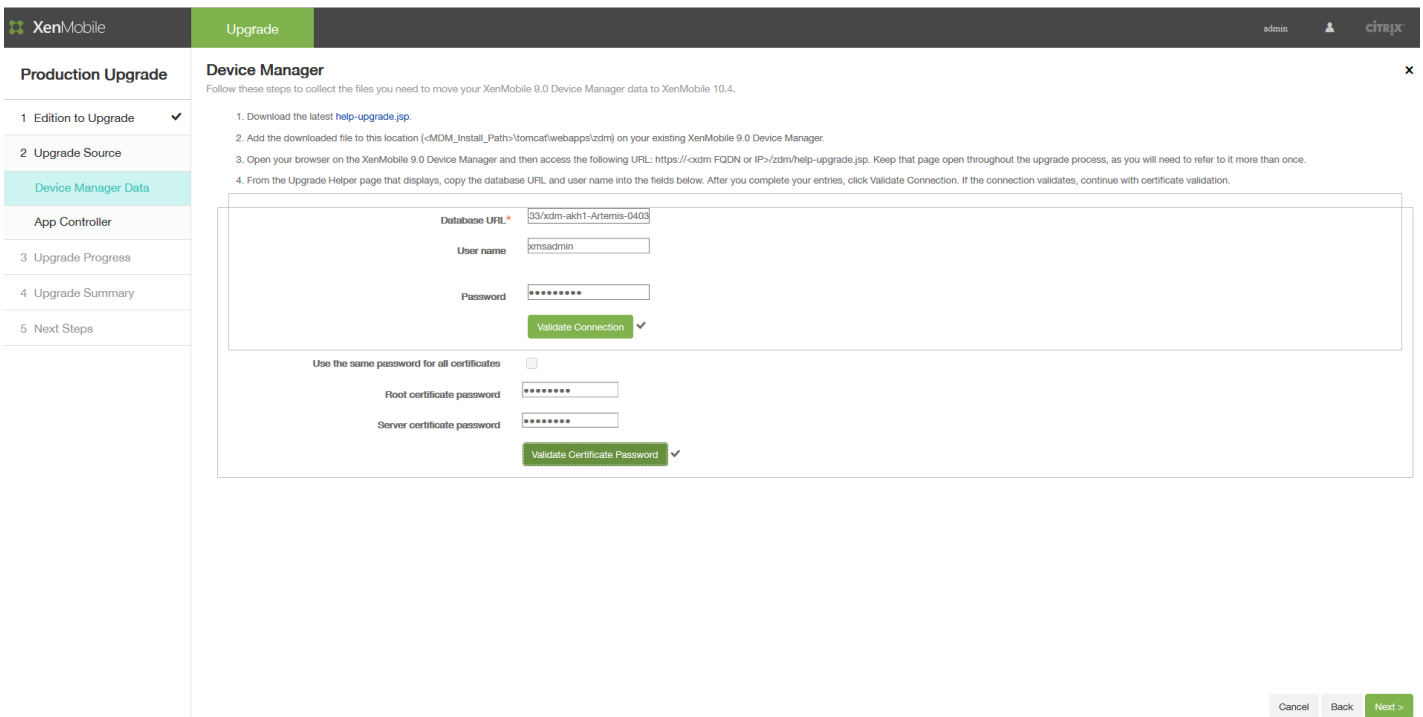

21. Click **Next**.

22. If you changed the ew-config.properties file, restart the xdm service on XenMobile 9 MDM and then go to <https://localhost/zdm/help-upgrade.jsp> to run the zip again. Doing so re-reads the ew-config.properties file and saves it to the XenMobile MDM 9 database to prepare for migration.

23. Next you apply an upgrade patch to App Controller and then generate and upload a support bundle. Start by following the instructions in section 1 of the **App Controller** page to upgrade App Controller.

XenMobile Upgrade App Controller

1 Edition to Upgrade

2 Upgrade Source

Device Manager Data

App Controller

3 Upgrade Progress

4 Upgrade Summary

5 Next Steps

1. Before upgrading from XenMobile 9.0 to XenMobile 10.4, you must apply the latest App Controller patch to App Controller. Steps to apply the patch:

1. Download the patch from the Citrix Downloads site.
2. Log on to App Controller.
3. Go to Settings > Release Management.
4. Click Import.
5. Select the patch you downloaded in Step 1.
6. Click Upload.

2. After you apply the patch, follow the steps below to generate support bundle. The support bundle captures all important information to upgrade to XenMobile 10.4.

1. In the App Controller command-line console, type 4 and then press Enter to open the Troubleshooting menu.
2. In the Troubleshooting menu, type 3 and then press Enter to open the Support Bundle menu.
3. In the Support Bundle menu, type 1, press Enter, and then follow the command prompts.
4. You must encrypt the support bundle. To do so, type y, press Enter, and then follow the command prompts.

3. Upload the support bundle from the previous step.

Upload

Cancel Back Next >

25. Continue to the instructions in section 2 of the **App Controller** page:

a. In the App Controller command-line console, type **4** and then press ENTER to open the Troubleshooting menu.

```
AppController 9.0.0.973503, 2015-05-06
-----
Main Menu
-----
[0] Express Setup
[1] High Availability
[2] Clustering
[3] System
[4] Troubleshooting
[5] Help
[6] Log Out
-----
Choice: [0 - 6] 4
-----
Troubleshooting Menu
-----
[0] Back to Main Menu
[1] Network Utilities
[2] Logs
[3] Support Bundle
-----
Choice: [0 - 3] █
```

b. In the Troubleshooting menu, type **3** and then press ENTER to open the Support Bundle menu.

```
[6] Log Out
-----
Choice: [0 - 6] 4
-----
Troubleshooting Menu
-----
[0] Back to Main Menu
[1] Network Utilities
[2] Logs
[3] Support Bundle
-----
Choice: [0 - 3] 3
-----
Support Bundle Menu
-----
[0] Back to Troubleshooting Menu
[1] Generate Support Bundle
[2] Encrypt Existing Support Bundle
[3] Upload Support Bundle by Using SCP
[4] Upload Support Bundle by Using FTP
-----
Choice: [0 - 4] █
```

c. In the Support Bundle menu, type **1**, press ENTER, and then follow the command prompts.

Note: Ensure that you encrypt the support bundle.

```
[6] Log Out
-----
Choice: [0 - 6] 4
-----
Troubleshooting Menu
-----
[0] Back to Main Menu
[1] Network Utilities
[2] Logs
[3] Support Bundle
-----
Choice: [0 - 3] 3
-----
Support Bundle Menu
-----
[0] Back to Troubleshooting Menu
[1] Generate Support Bundle
[2] Encrypt Existing Support Bundle
[3] Upload Support Bundle by Using SCP
[4] Upload Support Bundle by Using FTP
-----
Choice: [0 - 4] 1
```

26. In section 3 of the **App Controller** page, specify the support bundle and then click **Upload**.

The Upgrade Tool processes the collected files (for XenMobile Enterprise and MAM editions) and the support bundle. This

step may take more than 15 minutes if you are migrating many users.

27. Click **Next**. The **Start** confirmation dialog box appears.

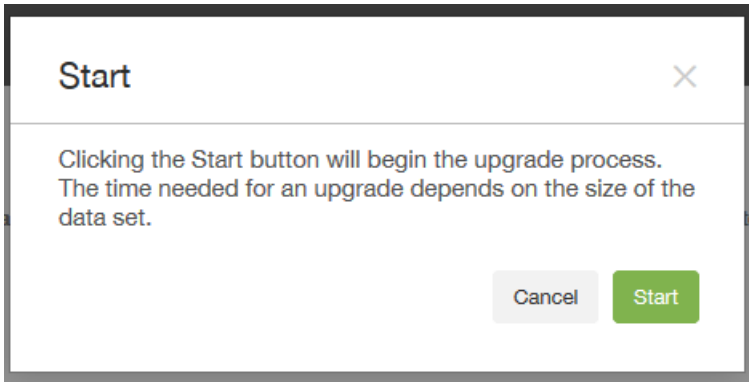

28. Click **Start**. The **Upgrade Progress** page appears with progress indicators to let you track the data upgrade from XenMobile 9.0. When the upgrade is complete, the progress indicators are at 100% and the **Next** button is enabled.

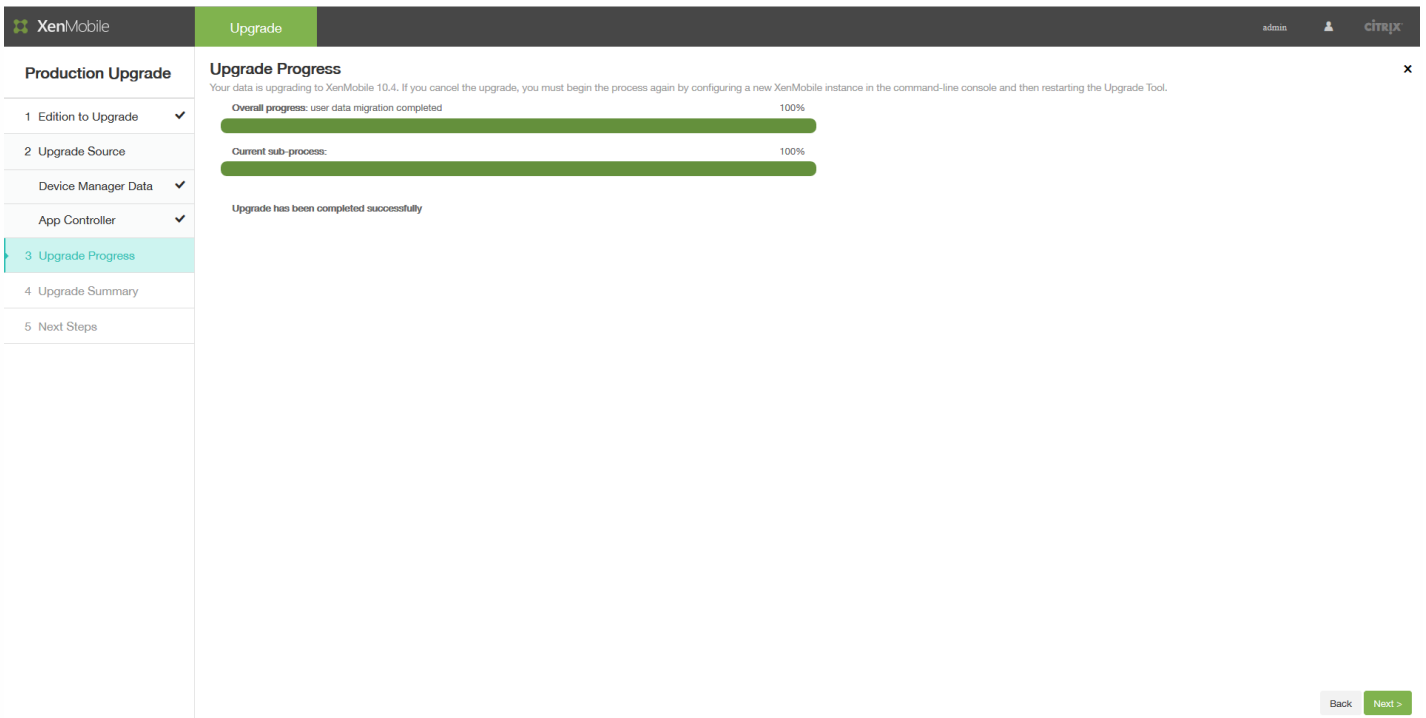

Note

If the upgrade fails, you can view the logs to understand the reason for the error. Then, import a new XenMobile instance and restart the upgrade process. You cannot use the Back button in the browser to return to earlier pages and correct information.

The Upgrade Progress page lets you know when the upgrade has completed successfully.

29. Click **Next**. The **Upgrade Summary** page appears.

If you are upgrading an Enterprise or MAM edition, the **Upgrade Summary** page might look like the following:

The screenshot shows the XenMobile Upgrade Summary page for an Enterprise or MAM edition. The page is titled "Upgrade Summary" and includes a sub-header "Production Upgrade". The main content area displays a list of upgrade statistics:

Upgrade Step	Count
Devices Upgraded	5
Apps Upgraded	46
Users Upgraded	323
Delivery Groups Upgraded	12
Policies Upgraded	44
Smart Actions Upgraded	0

The page also features a sidebar with navigation steps: 1 Edition to Upgrade, 2 Upgrade Source, 3 Upgrade Progress, 4 Upgrade Summary (highlighted), and 5 Next Steps. At the bottom right, there are buttons for "Cancel", "Back", and "Next >".

If you are upgrading an MDM edition, the **Upgrade Summary** page might look like the following:

The screenshot shows the XenMobile Upgrade Summary page for an MDM edition. The page is titled "Upgrade Summary" and includes a sub-header "Production Upgrade". The main content area displays a list of upgrade statistics:

Upgrade Step	Count
Devices Upgraded	604
Apps Upgraded	23
Users Upgraded	316
Delivery Groups Upgraded	5

The page also features a sidebar with navigation steps: 1 Edition to Upgrade, 2 Upgrade Source, 3 Upgrade Progress, 4 Upgrade Summary (highlighted), and 5 Next Steps. At the bottom right, there are buttons for "Cancel", "Back", and "Next >".

30. Click the **Upgrade log** icon to download the log. Be sure to download the log before leaving this page.

Citrix recommends that you review the log to determine whether any items weren't upgraded to the latest version of XenMobile. Such items include policies, settings, user data, and so on.

31. After you download the upgrade log, click **Next**. The **Next Steps** page appears.

The screenshot shows the XenMobile Upgrade interface. The top navigation bar includes the XenMobile logo, the 'Upgrade' tab, and user information (admin, citrix). The main content area is divided into two sections: 'Production Upgrade' and 'Next Steps'. The 'Production Upgrade' section contains a list of steps: 1. Edition to Upgrade, 2. Upgrade Source, Device Manager Data, App Controller, 3. Upgrade Progress, 4. Upgrade Summary, and 5. Next Steps. The 'Next Steps' section contains a list of instructions: 1. You must configure licenses on XenMobile 10.4 to enable user connections. To do so, go to Configure > Settings > Licensing. 2. If you deployed the server running XenMobile 9.0 in the DMZ, you must change the external DNS for XenMobile to point to the new XenMobile 10.4 server. 3. If you deployed the server running XenMobile 9.0 behind a load balancing NetScaler appliance, in NetScaler, you must configure the load balancing Device Manager instance with the new IP address for the XenMobile 10.4 server. 4. If you deploy XenMobile 10.4 in a cluster, you must use the command-line interface to enable cluster support and then join the new XenMobile nodes. A 'Note' section follows, with a warning icon and instructions to collect a support bundle from a newly upgraded XenMobile server before restarting it. The note includes three steps: 1. In the command-line console, type 3 and then press Enter to open the Troubleshooting menu. 2. In the Troubleshooting menu, type 3 and then press Enter to open the Support Bundle menu. 3. In the Support Bundle menu, type 2, press Enter to Generate support bundle. Below the note, it says 'Restart the server. Go to Manage > Device and make sure all devices have been upgraded properly before making any NetScaler changes.' At the bottom right, there are three buttons: 'Cancel', 'Back', and 'Finish & Restart'.

For instructions related to those steps, see [Upgrade Tool Post-Requisites](#).

Upgrade Tool post-requisites

Jun 19, 2017

After the Upgrade Tool completes, the tool provides a general list of next steps. The post-requisite tasks for your environment can vary, based on your installed NetScaler version, whether you used the NetScaler for XenMobile wizard to configure NetScaler, and your XenMobile Edition.

Be sure to review the following list of post-requisite tasks and complete all that apply to your environment.

1. Configure licenses on XenMobile to enable user connections. For details, see this [procedure](#).
2. If you deployed the server running XenMobile 9.0 in the DMZ, change the external DNS for XenMobile to point to the new XenMobile server instance.
3. If you deployed the server running XenMobile 9.0 behind a load balancing NetScaler appliance, make the following changes on NetScaler:
 - a. Configure a new load balancing virtual server for the upgrade. For details, see this [procedure](#).
 - b. Configure an address record to point the App Controller server FQDN to the new load balancer for the upgrade. For details, see this [procedure](#).
 - c. Change the Device Manager load balancing virtual server to point to the new XenMobile server IP address. For details, see this [procedure](#).
 - d. Change the NetScaler Gateway to point to the new XenMobile server FQDN. For details, see this [procedure](#).
 - e. The following tasks are required only in these cases:
 - If you used the NetScaler for XenMobile wizard 9 with NetScaler 11.1, 11.0, or 10.5; or
 - If you're using NetScaler Gateway 10.1 (which is not recommended); or
 - If you didn't use the NetScaler for XenMobile wizard when configuring NetScaler 10.5 or later for XenMobile.

For the procedures that you should follow for the preceding cases, see the following articles in XenMobile Upgrade Tool 10.1 documentation:

[Create a new MAM Load Balancing Virtual Server Based on an SSL Bridge MDM Configuration](#)
[Create a new MAM Load Balancing Virtual Server Based on an SSL Offload MDM Configuration](#)

4. If you deploy the latest version of XenMobile in a cluster, you must use the XenMobile command-line interface (CLI) to enable cluster support and then join the new XenMobile nodes. For help with the XenMobile CLI, see [Clustering Menu Options](#).
5. Complete the remaining post-requisites, as required for your environment.

This article also covers post-requisites for settings related to Secure Ticket Authority, Network Time Protocol (NTP) server, XenMobile server host name, update information that did not upgrade, custom store name, and XenMobile device enrollment after upgrade.

Configure licenses on XenMobile to enable user connections

The latest versions of XenMobile only support Citrix V6 licensing. You must set the local or remote license configuration in the new XenMobile console to enable user connections, as follows.

1. Download the license file. To do so, see [Citrix Licensing](#).
2. Log on to the new XenMobile console: Go to <https://<XenMobile-server-IP-address>:4443>.
 - For MDM or ENT upgrades, log on with your XenMobile 9.0 Device Manager administrator credentials.
 - For MAM upgrades, log on with your XenMobile 9.0 App Controller administrator credentials.
3. Go to **Settings > Licensing**.

Settings > Licensing

Licensing

XenMobile comes with an evaluation license valid for 30 days. If you decide to use your Citrix license, you can configure it at any time. You can install your Citrix license locally or remotely on the license server.

License type: Remote license

License server*: lic1.xmlab.net

Port*: 27000

Test Connection

Product name	Status	Active	Total number of licenses	Number used	Type	Expires on
--------------	--------	--------	--------------------------	-------------	------	------------

For more details about adding local and remote licenses, see [Licensing](#).

Configure a new load balancing virtual server for the upgrade

Important

This post-requisite is required *only* when you upgrade a XenMobile Enterprise Edition production upgrade; it is not required for MAM or MDM upgrades.

After a XenMobile Enterprise Edition production upgrade to the latest version of XenMobile, you must configure a new load balancing virtual server for the XenMobile 9.0 App Controller FQDN. To do that, you use the NetScaler Gateway configuration tool.

The example screens in this section, for NetScaler Gateway 11.1, are similar to NetScaler Gateway versions 11.0 and 10.5.

1. Click **Traffic Management > Load Balancing > Virtual Servers**.

Dashboard Configuration Reporting Documentation Downloads

Traffic Management / Load Balancing / Virtual Servers

Virtual Servers

<input type="checkbox"/>	Name	State	Effective State	IP Address	Port
<input type="checkbox"/>	_XM_MAM_LB_192.168.2.10_8443	● UP	● UP	192.168.2.10	8443
<input type="checkbox"/>	_XM_LB_MDM_XenMobileMDM_172.16.30.38_443	● UP	● UP	172.16.30.38	443
<input type="checkbox"/>	_XM_LB_MDM_XenMobileMDM_172.16.30.38_8443	● UP	● UP	172.16.30.38	8443

2. Click **Add**.

3. On the **Load Balancing Virtual Server** page, configure the following settings and then click **OK**.

Dashboard Configuration Reporting Documentation Downloads

Load Balancing Virtual Server

Basic Settings

Create a virtual server by specifying a name, an IP address, a port, and a protocol type. If an application is accessible from the Internet, the virtual server IP (VIP) address is a public IP address. If the application is accessible only from the local area network (LAN) or wide area network (WAN), the VIP is usually a private (ICANN non-routable) IP address. You can configure multiple virtual servers to receive client requests, thereby increasing the availability of resources to process client requests.

Name*

Protocol*

IP Address Type*

IP Address*

Port*

► More

- **Name:** Type a name for the new load balancer.
- **Protocol:** Set to **SSL**. The default is **HTTP**.
- **IP Address:** Enter an IP address for the new load balancer, which follows RFC 1918; for example 192.168.1.10.
- **Port:** Set to **443**.

4. Under **Services and Service Groups**, click **No Load Balancing Virtual Server Service Group Binding**.

Dashboard Configuration Reporting Documentation Downloads

Load Balancing Virtual Server

Load Balancing Virtual Server | [Export as a Template](#)

Basic Settings			
Name	MigrationLB	Listen Priority	-
Protocol	SSL	Listen Policy Expression	NONE
State	UP	Range	1
IP Address	192.168.1.10	Redirection Mode	IP
Port	443	RHI State	PASSIVE
Traffic Domain	0	AppFlow Logging	ENABLED
		Redirect From Port	
		HTTPS Redirect URL	

Services and Service Groups

- No Load Balancing Virtual Server Service Binding
- No Load Balancing Virtual Server ServiceGroup Binding**

5. Under **Select Service Group Name**, click **Click to Select**.

Load Balancing Virtual Server ServiceGroup Binding / ServiceGroup Binding

ServiceGroup Binding

Select Service Group Name*

Click to select > + ✎

Bind Close

6. Click **Add** to create a new service group.

Load Balancing Virtual Server ServiceGroup Binding / ServiceGroup Binding / Service Groups

Service Groups

Select Add Edit Delete Manage Members Statistics Action Search

7. On the **Load Balancing Service Group** page, type a name for the new service group, make sure the protocol is set to **SSL**, and then click **OK**.

Load Balancing Virtual Server ServiceGroup Binding / ServiceGroup Binding / Service Groups / Load Balancing Service Group

Load Balancing Service Group

Basic Settings Help

Name*
NewXMS

Protocol*
SSL

Traffic Domain
+ /

Cache Type*
SERVER

AutoScale Mode

Cacheable
 State
 Health Monitoring
 AppFlow Logging

Monitoring Connection Close Bit

Number of Active Connections

Comment

OK Cancel

8. Click **No Service Group Member**.

Load Balancing Service Group

Basic Settings

Name	NewXMS	Cache Type	SERVER
Protocol	SSL	Cacheable	NO
State	ENABLED	Health Monitoring	YES
Effective State	● UP	AppFlow Logging	ENABLED
Traffic Domain	0	Monitoring Connection Close Bit	NONE
Comment		Number of Active Connections	0
		AutoScale Mode	DISABLED

Service Group Members

No Service Group Member

9. On the **Create Service Group Member** page, configure the following settings:

- **IP Address/IP Address Range:** Enter the IP address for the new XenMobile server instance.
- **Port:** Set to **8443**.
- **Server ID:** If you are migrating from a clustered XenMobile 9.0 environment to a new XenMobile clustered environment, enter the server node ID for the current XenMobile server. To obtain the server node ID, log on to the XenMobile server command-line interface (CLI) and type **1** to go to the **Clustering** menu. The server node ID in the CLI is labelled **Current Node ID**.

```

-----
Clustering Menu
-----
[0] Back to Main Menu
[1] Show Cluster Status
[2] Enable/Disable cluster
[3] Cluster member white list
[4] Enable or Disable SSL offload
[5] Display Hazelcast Cluster
-----
Choice: [0 - 5] 1
Current Node ID: 181356771
    
```

Load Balancing Virtual Server ServiceGroup Binding / ServiceGroup Binding / Service Groups / Load Balancing Service Group / Service Group Members Binding / Create Service Group

Create Service Group Member

IP Based
 Server Based

IP Address/IP Address Range*

10 . 207 . 87 . 38 IPv6 -

Port*

8443

Weight

1

Server Id

181356771

Hash Id

12345

State

10. Click **Create** and then click **Done**.

Load Balancing Virtual Server ServiceGroup Binding / Load Balancing Service Group

Load Balancing Service Group

Basic Settings 

Name	NewXMS	Cache Type	SERVER
Protocol	SSL	Cacheable	NO
State	ENABLED	Health Monitoring	YES
Effective State	UP	AppFlow Logging	ENABLED
Traffic Domain	0	Monitoring Connection Close Bit	NONE
Comment		Number of Active Connections	0
		AutoScale Mode	DISABLED

Service Group Members

1 Service Group Member 

11. Click **Done** and then **OK**.

12. Click **Bind** and then on the next screen, click **Done**.

Load Balancing Virtual Server ServiceGroup Binding / ServiceGroup Binding

ServiceGroup Binding

Select Service Group Name*

NewXMS > + ✎

Bind Close

13. Under **Certificates**, click **No Server Certificate**.

Dashboard Configuration Reporting Documentation Downloads

Load Balancing Virtual Server

Load Balancing Virtual Server | Export as a Template

Basic Settings

Name	MigrationLB	Listen Priority	-
Protocol	SSL	Listen Policy Expression	NONE
State	UP	Range	1
IP Address	192.168.1.10	Redirection Mode	IP
Port	443	RHI State	PASSIVE
Traffic Domain	0	AppFlow Logging	ENABLED
		Redirect From Port	
		HTTPS Redirect URL	

Services and Service Groups

- No Load Balancing Virtual Server Service Binding >
- 1 Load Balancing Virtual Server ServiceGroup Binding >

Certificate

- No Server Certificate >
- No CA Certificate >

14. Under **Server Certificate Binding**, click **Click to Select**.

SSL Virtual Server Server Certificate Binding / Server Certificate Binding

Server Certificate Binding

Select Server Certificate*

Click to select > +

Server Certificate for SNI

Bind Close

15. Under **Certificates**, click the XenMobile 9.0 server certificate you exported in [Upgrade Tool prerequisites](#) and then click **OK**.

The screenshot shows the 'Server Certificates' management page. At the top, there is a breadcrumb trail: 'SSL Virtual Server Server Certificate Binding / Server Certificate Binding / Server Certificates'. Below this is the title 'Server Certificates'. A toolbar contains buttons for 'Select', 'Install', 'Update', 'Delete', and an 'Action' dropdown menu. A table lists four certificates with columns for 'Name', 'Common Name', and 'Issuer Name'. Each row has a radio button to its left.

	Name	Common Name	Issuer Name
<input type="radio"/>	ns-sftrust-certificate	XXXXXXXXXXXX	XXXXXXXXXXXX
<input type="radio"/>	ns-server-certificate	XXXXXXXXXX	XXXXXXXXXX
<input type="radio"/>	xs-full	XXXXXXXX.com	XXXXXXXXXXXX
<input type="radio"/>	xmlab-server	XXXXXXXX.net	XXXXXXXXXX

16. Click **Bind** and then on the next screen, click **Done**.

The screenshot shows the 'Server Certificate Binding' dialog box. It has a breadcrumb trail: 'SSL Virtual Server Server Certificate Binding / Server Certificate Binding'. The title is 'Server Certificate Binding'. Below the title is the text 'Select Server Certificate*'. A text input field contains 'xmlab-server', followed by a right-pointing arrow and a plus sign button. Below this is a checkbox labeled 'Server Certificate for SNI'. At the bottom, there are two buttons: 'Bind' and 'Close'.

← Load Balancing Virtual Server

Load Balancing Virtual Server | [Export as a Template](#)

Basic Settings

Name: MigrationLB	Listen Priority: -
Protocol: SSL	Listen Policy Expression: NONE
State: UP	Range: 1
IP Address: 192.168.1.10	Redirection Mode: IP
Port: 443	RHI State: PASSIVE
Traffic Domain: 0	AppFlow Logging: ENABLED
	Redirect From Port:
	HTTPS Redirect URL:

Services and Service Groups

- No** Load Balancing Virtual Server Service Binding >
- 1** Load Balancing Virtual Server ServiceGroup Binding >

Certificate

- 1** Server Certificate >
- No** CA Certificate >

17. Click the refresh button to confirm that the server is up.

Traffic Management / Load Balancing / Virtual Servers

Virtual Servers

↻ ? 🔗

Add Edit Delete Enable Disable Statistics Action ▾ Search ▾

<input type="checkbox"/>	Name	State	Effective State	IP Address	Port	Protocol	Method
<input type="checkbox"/>	MigrationLB	● UP	● UP	192.168.1.10	443	SSL	LEASTCONNECT
<input type="checkbox"/>	_XM_MAM_LB_192.168.2.10_8443	● UP	● UP	192.168.2.10	8443	SSL	LEASTCONNECT
<input type="checkbox"/>	_XM_LB_MDM_XenMobileMDM_172.16.30.38_443	● UP	● UP	172.16.30.38	443	SSL_BRIDGE	LEASTCONNECT
<input type="checkbox"/>	_XM_LB_MDM_XenMobileMDM_172.16.30.38_8443	● UP	● UP	172.16.30.38	8443	SSL_BRIDGE	LEASTCONNECT

Configure an address record to point the App Controller server FQDN to the new load balancer for the upgrade

1. Log on to NetScaler, click **Traffic Management > DNS > Records > Address Records**, and then click **Add**.

Note

If you have a Global Server Load Balancing configuration, adding an address record causes the Global Server Load Balancing system to respond authoritatively for that server with the local IP address.

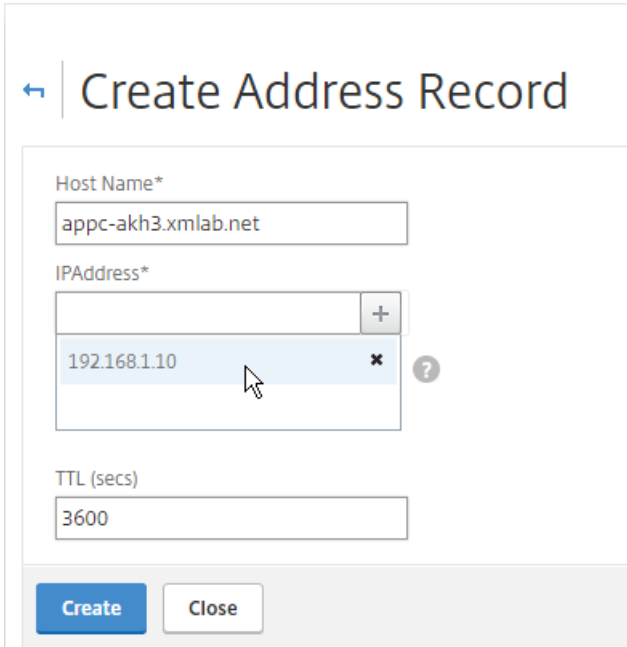

← Create Address Record

Host Name*
appc-akh3.xmlab.net

IPAddress*
192.168.1.10

TTL (secs)
3600

Create Close

Change the Device Manager load balancing virtual server to point to the new XenMobile server IP address

If you deployed the server running XenMobile 9.0 behind a load balancing NetScaler appliance, you must configure the load balancing XenMobile 9.0 Device Manager instance in NetScaler with the new IP address for the new XenMobile server instance.

The procedure differs depending on whether you're using NetScaler 11.1 or NetScaler versions 11.0 or 10.5.

For NetScaler 11.1

1. Under **Integrate with Citrix Products**, click **XenMobile**.

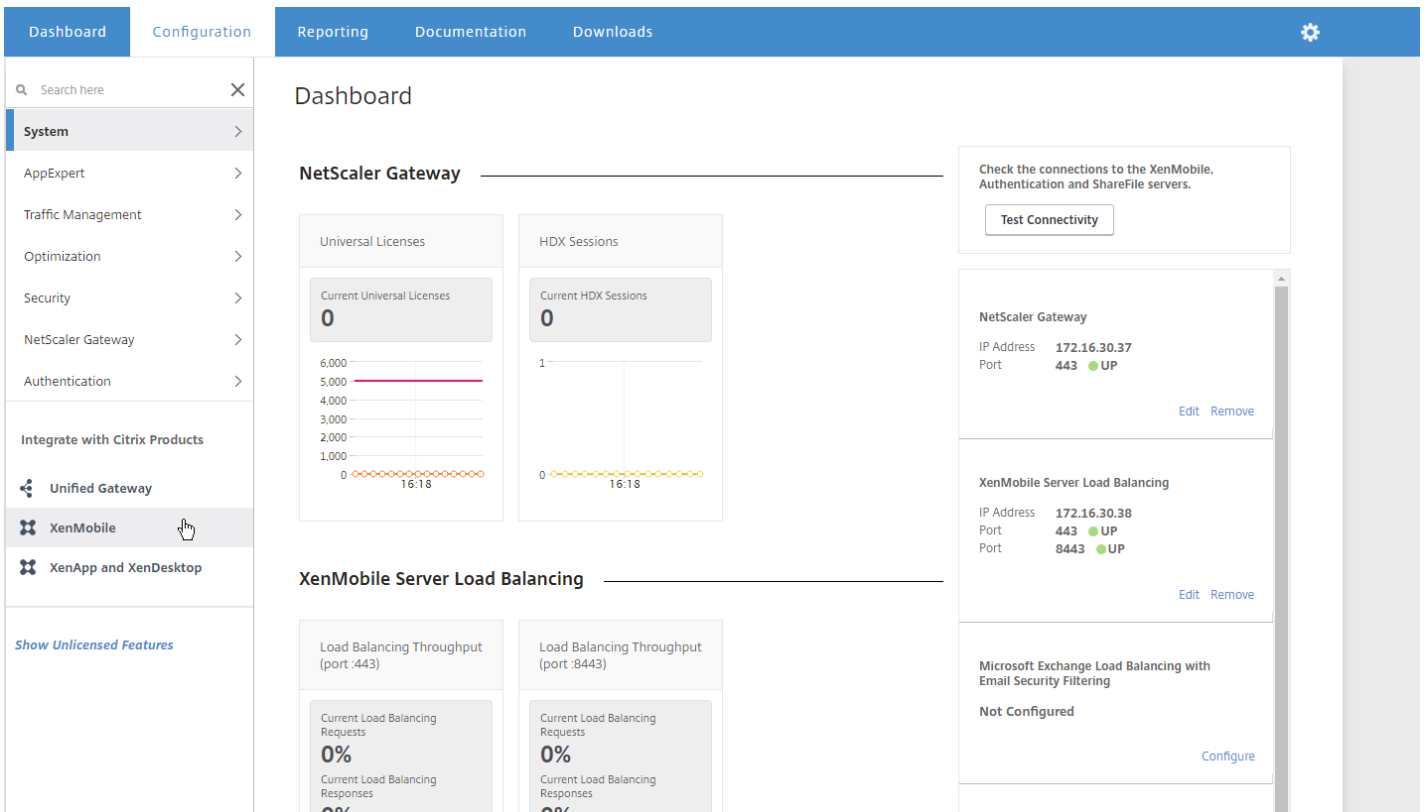

2. On the right side of the screen, under **XenMobile Server Load Balancing**, click **Edit**.

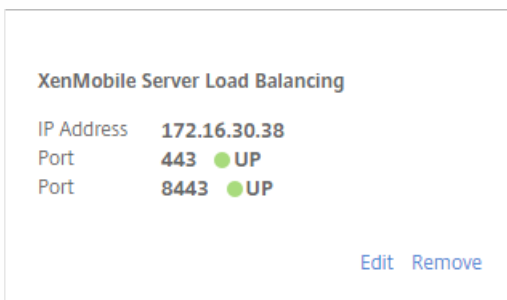

The **Load Balancing XenMobile Server Network Traffic** page appears.

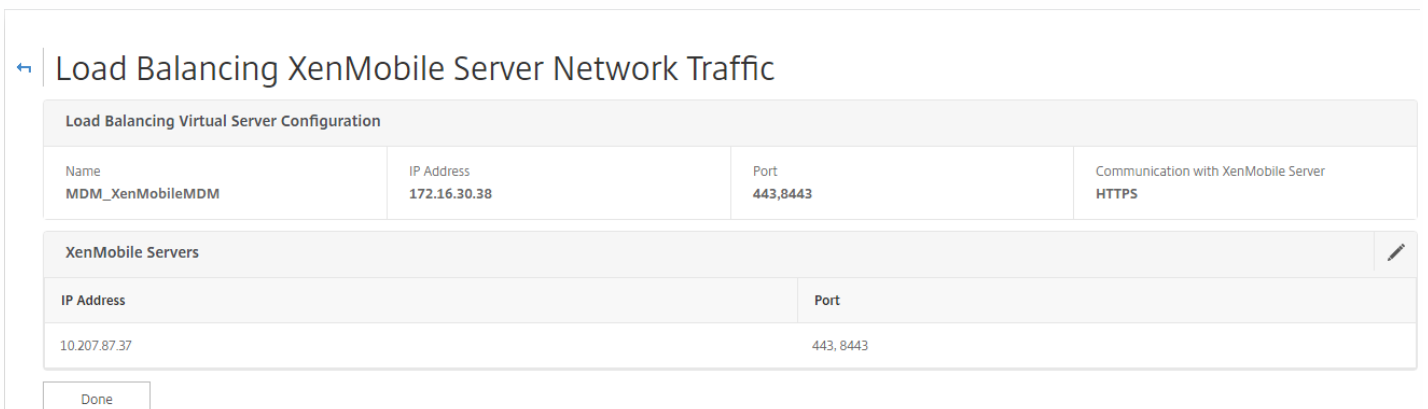

3. Click the pen icon for XenMobile Servers to open those settings.

← Load Balancing XenMobile Server Network Traffic

Load Balancing Virtual Server Configuration

Name	IP Address	Port	Communication with XenMobile Server
MDM_XenMobileMDM	172.16.30.38	443,8443	HTTPS

XenMobile Servers

Add Server Remove Server

<input type="checkbox"/>	IP Address	Port
<input type="checkbox"/>	10.207.87.37	443, 8443

Continue

4. Select the 9.0 Device Manager server IP address and then click **Remove Server**.

← Load Balancing XenMobile Server Network Traffic

Load Balancing Virtual Server Configuration

Name	IP Address	Port	Communication with XenMobile Server
MDM_XenMobileMDM	172.16.30.38	443,8443	HTTPS

XenMobile Servers

Add Server Remove Server

<input checked="" type="checkbox"/>	IP Address	Port
<input checked="" type="checkbox"/>	10.207.87.37	443, 8443

Continue

5. Click **Add Server** and then add the new XenMobile server IP address.

XenMobile Server IP Addresses

Enter the IP address of the XenMobile server that you want to load balance.

XenMobile Server IP Address*

10 . 207 . 87 . 38

Add Cancel

For NetScaler versions 11.0 or 10.5

1. Under **Integrate with Citrix Products**, click **XenMobile**.

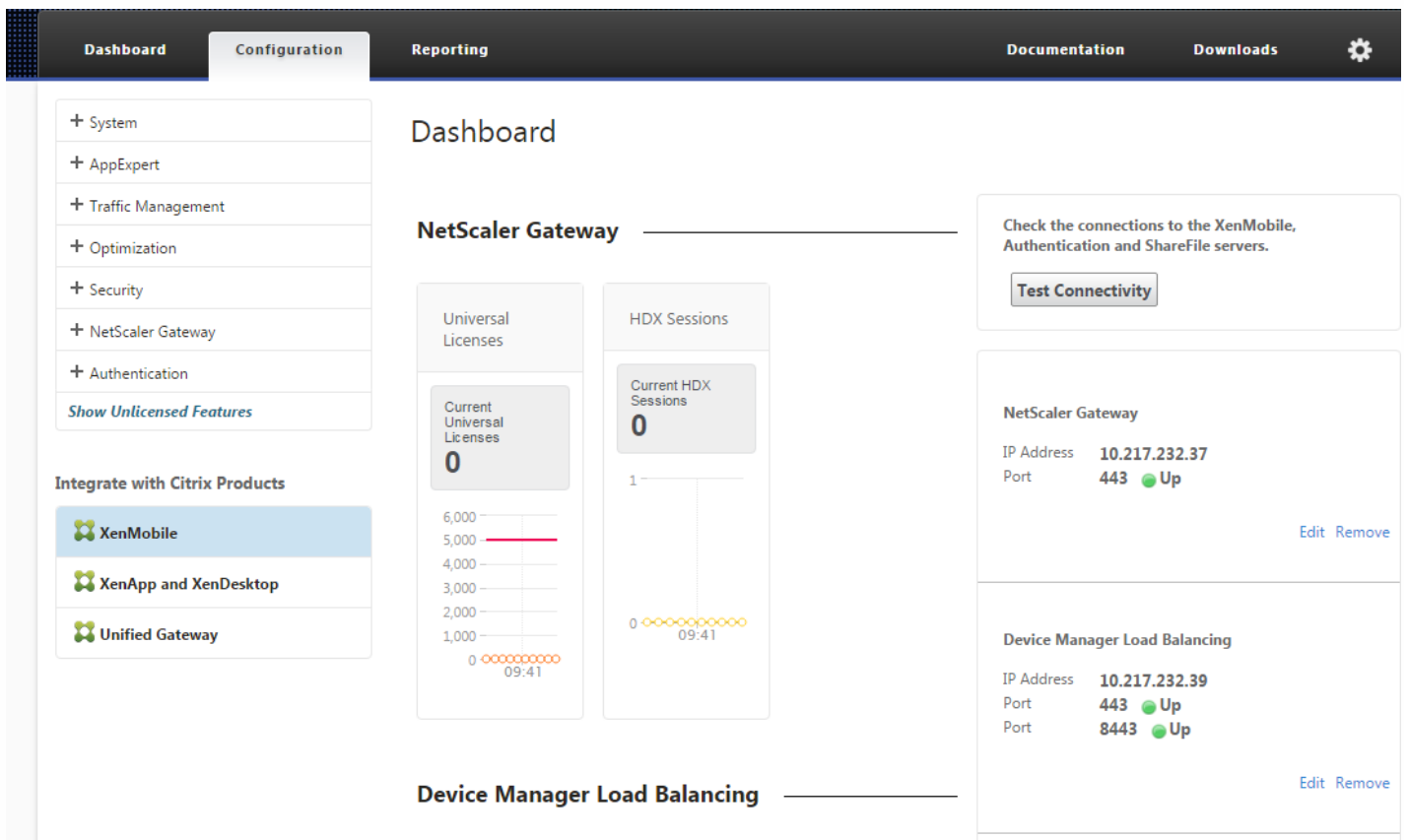

2. On the right side of the screen, under **Device Manager Load Balancing**, click **Edit**.

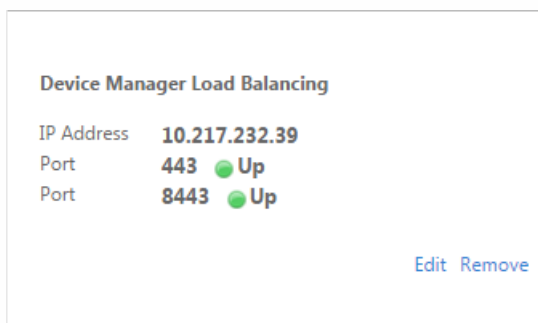

The **Load Balancing Device Manager Network Traffic** page appears.

Load Balancing Device Manager Network Traffic

Load Balancing Virtual Server Configuration		
Name	IP Address	Port
MDM_XenMobileMDM	10.217.232.39	443,8443

Device Manager Server IP Addresses		
IP Address	Port	State
10.207.72.216	443, 8443	Up

Done

3. Click the pen icon for **Device Manager Server IP Addresses** to open those settings.

Device Manager Server IP Addresses		
Add Server	Remove Server	Add from existing servers
IP Address	Port	State
10.207.72.216	443, 8443	Up

Continue

4. Select the 9.0 Device Manager server IP address and then click **Remove Server**.

Device Manager Server IP Addresses		
Add Server	Remove Server	Add from existing servers
IP Address	Port	State
10.207.72.216	443, 8443	Up

Continue

5. Click **Add Server** and then add the new XenMobile server IP address.

Device Manager Server IP Addresses	
Enter the IP address(es) of the device manager server(s) that you want to load balance. If the server IP address is already added to the NetScaler, click Add from existing servers to select the device manager server IP.	
Device Manager Server IP Address*	
<input type="text" value="10 . 207 . 87 . 38"/>	
Add	Cancel

Change NetScaler Gateway to point to the new XenMobile server FQDN

At this point, NetScaler Gateway points to the App Controller FQDN. You must change NetScaler to point to the new XenMobile FQDN. The latest versions of XenMobile listen on port 8443 instead of port 443. If you used the NetScaler for XenMobile wizard 9 to set up your NetScaler, you must include the port number with the FQDN, as shown in the examples in the following tables.

XenMobile Enterprise Edition

Change the App Controller FQDN to point to the new XenMobile FQDN, which is the XenMobile 9.0 Device Manager FQDN followed by port 8443. The following table shows an example.

XenMobile 9.0 Component	Component FQDN	New XenMobile Enterprise Edition FQDN
Device Manager	enroll.example.com	enroll.example.com:8443
App Controller	appc.example.net	N/A
NetScaler Gateway	access.example.com	N/A

XenMobile App Edition

Change the App Controller FQDN to point to the new XenMobile FQDN, which is the XenMobile 9.0 App Controller FQDN followed by port 8443. The following table shows an example.

XenMobile 9.0 Component	Component FQDN	New XenMobile Enterprise Edition FQDN
App Controller	appc.example.net	appc.example.net:8443
NetScaler Gateway	access.example.com	N/A

1. Under **Integrate with Citrix Products**, click **XenMobile**.
2. Under **NetScaler Gateway**, click **Edit**.

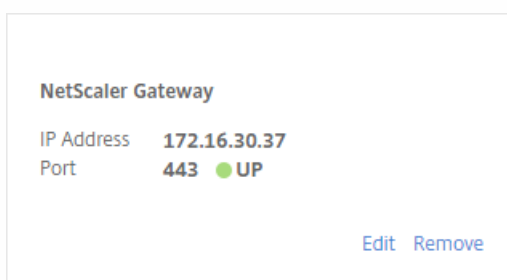

3. Click the pen icon next to **XenMobile Settings** and then change the App Controller FQDN to the XenMobile server FQDN and append **:8443** to the FQDN. For example, **SAMPLE-XENMOBILE.FQDN.COM:8443**.

XenMobile Settings

App Controller FQDN*
XDM-AKH3.XS.CITRIX.COM:8443

Split DNS mode for MicroVPN*
BOTH

Enable split tunneling

Continue Cancel

4. Click **Continue** and **Finish**.

Add the IP address or FQDN of the server running Secure Ticket Authority (STA)

Next, you must update your DNS to resolve the FQDN of the server running Secure Ticket Authority to the IP address of the new XenMobile Server instance. Sometimes after the post-requisite changes, the Secure Ticket Authority Server isn't bound in NetScaler, although it appears in the **VPN Virtual Server STA Server Binding** list.

In NetScaler Gateway, you add the IP address or FQDN of the server running the Secure Ticket Authority, as follows:

1. Click **Netscaler Gateway > Virtual Servers**.

Dashboard Configuration Reporting Documentation Downloads

Search here

System >
AppExpert >
Traffic Management >
Optimization >
Security >
NetScaler Gateway >
Global Settings
Virtual Servers

NetScaler Gateway / NetScaler Gateway Virtual Servers

NetScaler Gateway Virtual Servers

Add Edit Delete Statistics Visualizer Action

	Name	State	IP Address	Port	Protocol
<input type="checkbox"/>	_XM_ag-akh3	UP	172.16.30.37	443	SSL

2. Make sure that the NetScaler Gateway virtual server is in the **Up** state. Select the configured Netscaler Gateway Virtual Server and then click **Edit**.

3. Under **Published Applications**, click **STA server**.

Published Applications
No Next HOP Server
1 STA Server
No Url

4. Note the **Secure Ticket Authority Server** URL, which you will enter in step 6. Then select the Secure Ticket Authority Server in the list.

VPN Virtual Server STA Server Binding

Add Binding
Unbind

<input checked="" type="checkbox"/>	Secure Ticket Authority Server	Secure Ticket Authority Server Address Type
<input checked="" type="checkbox"/>	https://XDM-AKH3.XS.CITRIX.COM:8443	IPV4

Close

5. Click **Unbind** and then click **Add Binding**.

6. In the **Secure Ticket Authority Server** field, type the URL that you noted in step 4.

7. Click **Bind**, click **Close**, and then click **Done**.

NTP Settings

Make sure to sync the time on NetScaler and on XenMobile server. If possible, point NetScaler and XenMobile server to the same public Network Time Protocol (NTP) server.

Server property if your XenMobile 9.0 host name has uppercase letters

If your XenMobile 9.0 host name includes uppercase letters, complete the following steps so that mobile devices can access Citrix Store:

1. In the new XenMobile console, go to **Settings > Server Properties**.

2. Click **Add** and complete the fields as follows:

- **Key:** Select **Custom Key**.
- **Key:** Enter **host.name.uselowercase**.
- **Value:** Enter **true**.
- **Display name:** Enter a description for the key.

Settings > Server Properties > Add New Server Property

Add New Server Property

Key	<input type="text" value="Custom Key"/>	?
Key*	<input type="text" value="host.name.uselowercase"/>	
Value*	<input type="text" value="true"/>	
Display name*	<input type="text" value="Use lowercase for host name"/>	
Description	<input type="text"/>	

3. Restart the XenMobile server.

Update information that did not upgrade

Update the following as necessary:

- Managed Service Provider (MSP) group
- Custom Active Directory attributes
- RBAC roles

For an on-premises upgrade, RBAC settings have issues. For information, see [Known issues](#).

- Log settings
- Any configuration or user data listed in the migration.log file
- Any sys log server configuration

Custom store name

Before you upgraded, one of the prerequisite steps was to change a custom Citrix Store name back to its default value. If you did not complete that prerequisite, you must follow one of these post-requisite steps before using the latest version of XenMobile Server:

- If you have a large population of Windows devices, change the store name to the default value. After that, end users enrolled with iOS and Android devices must sign off from Citrix Secure Hub (previously Worx Home) and then sign in again.
- If you have fewer Windows devices than iOS and Android devices, the recommendation is to have the Windows users re-enroll their devices.

For more information about this issue, see <http://support.citrix.com/article/CTX214553>.

XenMobile device enrollment after upgrade

Users do not need to re-enroll their devices after you do a production upgrade to the latest version of XenMobile. The devices should connect automatically to the new XenMobile Server based on the heartbeat interval. Users may, however, be asked to re-authenticate before the device can reconnect.

After the user devices connect, check to make sure you see the devices in the XenMobile console, as shown in the following figure.

The screenshot shows the XenMobile console interface. At the top, there is a navigation bar with 'XenMobile' and tabs for 'Analyze', 'Manage', and 'Configure'. Below this, there are sub-tabs for 'Devices', 'Users', and 'Enrollment'. The 'Devices' tab is active, showing a 'Show filter' link. Below the navigation are icons for 'Add', 'Import', 'Export', and 'Refresh'. The main content is a table with the following columns: 'Status', 'Mode', 'User name', 'Device platform', and 'Operating system version'. There are two rows of device data.

Status	Mode	User name	Device platform	Operating system version
	MDM MAM	us1user1@... net "us1 user1"	Android	5.0.2
	MDM MAM	us3user3@... net "us3 user3"	iOS	8.4.1

Upgrade the MTC tenant server to XenMobile

Jun 19, 2017

If XenMobile 9.0 MDM or Enterprise Edition has Multi-Tenant Console (MTC) enabled, you can migrate MTC-managed XenMobile 9 instances to standalone instances of the latest version of XenMobile. XenMobile 10.x does not support MTC, so you must manage these upgraded instances on an individual basis.

1. Make sure that you configure network address translation (NAT) in front of all of the MTC clients.
2. Install an instance of the latest version of XenMobile.
3. If no port mapping is enabled on the MTC tenant, do the following:
 - a. Make sure that, for the new XenMobile instance, the server port that allows HTTPS communication with certificates (typically, port 443) and that allows HTTPS communication without certificates (8443) matches the port used for the XenMobile instance.
 - b. Configure a new port for management.
 - c. If port mapping is enabled, use the port that is mapped to and not the port that the XenMobile server listens on.
4. During the XenMobile server startup, use the instance name, **zdm**.
5. When you are enabling the Upgrade Tool through the XenMobile command-line interface, you must respond **Yes** to the upgrade prompt.
6. From the server from which you are upgrading, copy the following files from C:\Program Files (x86)\Citrix\XenMobile Device Manager for Multi-Tenant\tomcat\webapps\tenant-name\WEB-INF\classes:
 - ew-config.properties
 - pki.xml
 - variables.xml
7. Copy the following files from C:\Program Files (x86)\Citrix\XenMobile Device Manager for Multi-Tenant\tomcat\conf\tenant-name:
 - cacerts.pemjks
 - https.p12
 - pki-ca-devices.p12
 - pki-ca-root.p12
 - pki-ca-servers.p12
8. Make a copy of C:\Program Files (x86)\Citrix\XenMobile Device Manager for Multi-Tenant\tomcat\conf\server.xml and modify it as described in the following steps.
9. Remove all of the port connectors in use by the other tenant in server.xml, except keep port 80.
10. On the used port connector, remove the instance name from all file paths within the following range:
keystoreFile="C:\Program Files (x86)\Citrix\XenMobile Device Manager for Multi-Tenant\tomcat\conf\tenant-name\https.p12"

to:

```
keystoreFile="C:\Program Files (x86)\Citrix\XenMobile Device Manager for Multi-Tenant\tomcat\conf\https.p1"
```

11. Repeat step 10 for the file paths from:

```
truststoreFile="C:\Program Files (x86)\Citrix\XenMobile Device Manager for Multi-Tenant\tomcat\conf\tenant-name\cacerts.pem.jks"
```

to:

```
truststoreFile="C:\Program Files (x86)\Citrix\XenMobile Device Manager for Multi-Tenant\tomcat\conf\cacerts.pem.jks"
```

12. Create a .zip file with the files you copied in steps 6 - 8.

13. Open the IP address of the new XenMobile Server, as follows: `https://ipAddress:port/uw/?cloudMode`, where *port* is the HTTPS connection with a certificate. The upgrade wizard opens.

14. Using the steps described in the upgrade wizard, select **MDM** or **Enterprise**.

For **MDM** upgrades, the wizard prompts you to upload the .zip file. You must also validate that the database is correct and enter the password for the CA certificate.

For **Enterprise** upgrades, the wizard prompts you to upload the support bundle for App Controller.

15. After the XenMobile server restarts, sign on to the XenMobile console by using the IP address of your XenMobile server followed by the management port number.

16. Change the NAT to point to a new server.

17. Make necessary firewall changes to allow ports used by XenMobile server.

User accounts, roles, and enrollment

Jun 19, 2017

You configure the following items in the XenMobile console on the **Manage** tab and the **Settings** page:

- User accounts and groups
- Roles for user accounts and groups
- Enrollment mode and invitations

From the **Manage tab**, you can do the following:

- Click **Users** to add user accounts manually or use a .csv provisioning file to import the accounts and to manage local groups. For details, see:
 - [To add, edit, or delete local user accounts](#)
 - [To import user accounts by using a .csv provisioning file and Provisioning file formats](#)
 - [To add or remove groups in XenMobile](#)

You can also use workflows to manage the creation and removal of user accounts, as described later in this article in [Create and manage workflows](#).

- Click **Enrollment** to configure up to seven modes and to send enrollment invitations. Each enrollment mode its own level of security and number of steps users must take to enroll their devices. For details, see:
 - [To configure enrollment modes and enable the Self Help Portal](#)
 - [Enable autodiscovery in XenMobile for user enrollment](#)

From the **Settings** page, you can do the following:

- Click **Role-Based Access Control** to assign predefined roles, or sets of permissions, to users and groups. These permissions control the level of access users have to system functions. For details, see:
 - [Configuring Roles with RBAC](#)
- Click **Notification Templates** to use in automated actions, enrollment, and standard notification messages sent to users. You configure the notification templates to send messages over three different channels: Secure Hub, SMTP, or SMS. For details, see:
 - [Creating and updating Notification Templates](#)

To add, edit, or delete local user accounts

You can add local user accounts to XenMobile manually or you can use a provisioning file to import the accounts. For the steps to import user accounts from a provisioning file, see [To import user accounts by using a .csv provisioning file](#).

1. In the XenMobile console, click **Manage** > **Users**. The **Users** page appears.

To add a local user account

1. On the **Users** page, click **Add Local User**. The **Add Local User** page appears.

2. Configure these settings:

- **User name:** Type the name, a required field. You can include spaces in names, as well as upper and lowercase letters.
- **Password:** Type an optional user password.
- **Role:** In the list, click the user role. For more information about roles, see [Configuring Roles with RBAC](#). Possible options

are:

- ADMIN
- DEVICE_PROVISIONING
- SUPPORT
- USER
- **Membership:** In the list, click the group or groups to which to add the user.
- **User Properties:** Add optional user properties. For each user property you want to add, click **Add** and do the following:
 - **User Properties:** In the list, click a property and then type the user property attribute in the field next to the property.
 - Click **Done** to save the user property or click **Cancel**.

Note: To delete an existing user property, hover over the line containing the property and then click the X on the right side. The property is deleted immediately.

To edit an existing user property, click the property and make changes. Click **Done** to save the changed listing or **Cancel** to leave the listing unchanged.

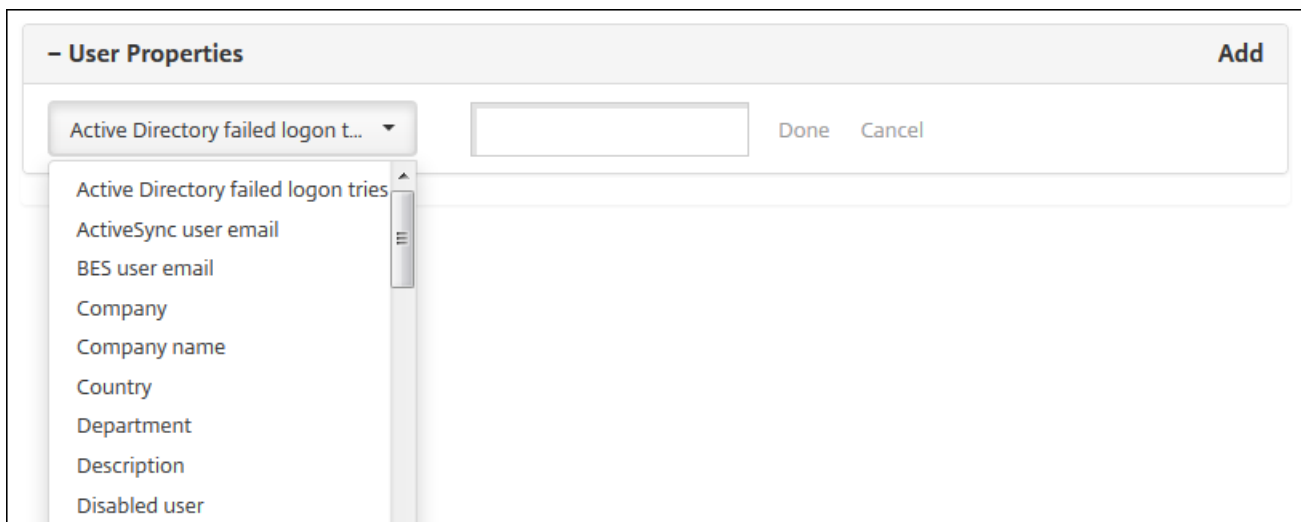

3. Click **Save**.

To edit a local user account

1. On the **Users** page, in the list of users, click to select a user and then click **Edit**. The **Edit Local User** page appears.

2. Change the following information as appropriate:

- **User name:** You cannot change the user name.
- **Password:** Change or add a user password.
- **Role:** In the list, click the user role.
- **Membership:** In the list, click the group or groups to which to add or edit the user account. To remove the user account from a group, clear the check box next to the group name.
- **User properties:** Do one of the following:
 - For each user property you want to change, click the property and make changes. Click **Done** to save the changed listing or **Cancel** to leave the listing unchanged.
 - For each user property you want to add, click **Add** and do the following:
 - **User Properties:** In the list, click a property and then type the user property attribute in the field next to the property.
 - Click **Done** to save the user property or click **Cancel**.
 - For each existing user property you want to delete, hover over the line containing the property and then click the X on the right side. The property is deleted immediately.

3. Click **Save** to save your changes or click **Cancel** to leave the user unchanged.

To delete a local user account

1. On the **Users** page, in the list of user accounts, click to select a user account.

Note: You can select more than one user account to delete by selecting the check box next to each user account.

2. Click **Delete**. A confirmation dialog box appears.

3. Click **Delete** to delete the user account or click **Cancel**.

To delete Active Directory users

To delete one or more Active Directory users at a time, select the users and click **Delete**.

If a user that you delete has enrolled devices and you want to re-enroll those devices, delete the devices before re-enrolling them. To delete a device, go to **Manage > Devices**, select the device, and then click **Delete**.

Importing user accounts

You can import local user accounts and properties from a .csv file called a provisioning file, which you can create manually. For more information about formatting provisioning files, see [Provisioning file formats](#).

Note:

- For local users, use the domain name along with the user name in the import file. For example, specify username@domain. If the local user that you create or import is for a managed domain in XenMobile, the user cannot enroll by using the corresponding LDAP credentials.
- If importing user accounts to the XenMobile internal user directory, disable the default domain to speed up the import process. Keep in mind that disabling the domain affects enrollments, so you should reenable the default domain after the import of internal users is complete.
- Local users can be in User Principal Name (UPN) format. However, Citrix recommends that you do not use the managed domain. For example, if example.com is managed, do not create a local user with this UPN format: user@example.com.

After you prepare a provisioning file, follow these steps to import the file to XenMobile.

1. In the XenMobile console, click **Manage > Users**. The **Users** page appears.

2. Click **Import Local Users**. The **Import Provisioning File** dialog box appears.

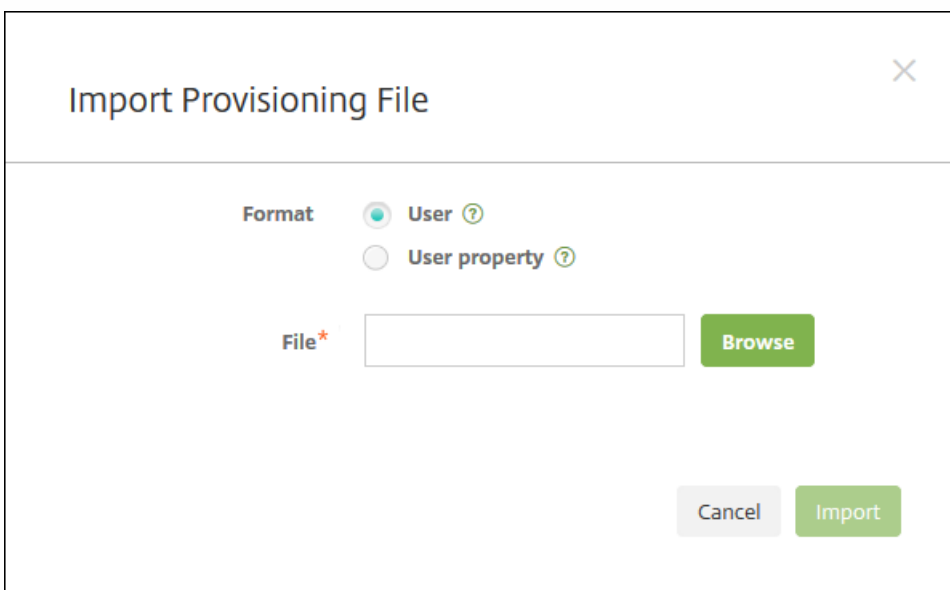

Import Provisioning File

Format User ? User property ?

File*

3. Select either **User** or **Property** for the format of the provisioning file you are importing.
4. Select the provisioning file to use by clicking **Browse** and then navigating to the file location.
5. Click **Import**.

Provisioning file formats

A provisioning file that you create manually and use to import user accounts and properties to XenMobile must be in one of the following formats:

- **User provisioning file fields:** user;password;role;group1;group2
- **User attribute provisioning file fields:** user;propertyName1;propertyValue1;propertyName2;propertyValue2

Note:

- Separate the fields within the provisioning file with a semi-colon (;). If part of a field contains a semi-colon, escape it with a backslash character (\). For example, type the property **propertyV;test;1;2** as **propertyV\;test\;1\;2** in the provisioning file.
- Valid values for **Role** are the predefined roles USER, ADMIN, SUPPORT, and DEVICE_PROVISIONING, plus any other roles that you defined.
- Use the period character (.) as a separator to create group hierarchy. Don't use a period in group names.
- Use lowercase for property attributes in attribute provisioning files. The database is case sensitive.

Example of user provisioning content

This entry, user01;pwd\;o1;USER;myGroup.users01;myGroup.users02;myGroup.users.users01, means:

- **User:** user01
- **Password:** pwd;01
- **Role:** USER
- **Groups:**
 - myGroup.users01
 - myGroup.users02
 - myGroup.users.users01

As another example, AUser0;1.password;USER;ActiveDirectory.test.net, means:

- **User:** AUser0
- **Password:** 1.password
- **Role:** USER
- **Group:** ActiveDirectory.test.net

Example of user attribute provisioning content

This entry, user01;propertyN;propertyV\;test\;1\;2;prop 2;prop2 value, means:

- **User:** user01
- **Property 1**
 - **name:** propertyN

- **value:** propertyV;test;1;2
- **Property 2:**
 - **name:** prop 2
 - **value:** prop2 value

To configure enrollment modes and enable the Self Help Portal

You configure device enrollment modes to allow users to enroll their devices in XenMobile. XenMobile offers seven modes, each with its own level of security and steps users must take to enroll their devices. You can make some modes available on the Self Help Portal. Users can log on to the portal and generate enrollment links that allow them to enroll their devices or choose to send themselves an enrollment invitation. You configure enrollment modes in the XenMobile console from the **Settings > Enrollment** page.

You send enrollment invitations from the **Manage > Enrollment Invitations** page. For information, see [Send an enrollment invitation](#).

Note: If you plan to use custom notification templates, you must set up the templates before you configure enrollment modes. For more information about notification templates, see [Creating or Updating Notification Templates](#).

1. On the XenMobile console, click the gear icon in the upper-right corner of the console. The **Settings** page appears.
2. Click **Enrollment**. The **Enrollment** page appears, containing a table of all available enrollment modes. By default, all enrollment modes are enabled.
3. Select any enrollment mode in the list to edit it. Then, set the mode as the default, disable the mode, or allow users access through the Self Help Portal.

Note: When you select the check box next to an enrollment mode, the options menu appears above the enrollment mode list. When you click anywhere else in the list, the options menu appears on the right side of the listing.

XenMobile Analyze Manage Configure admin

Settings > Enrollment

Enrollment

Enable and disable enrollment modes for users. You can also enable the Self Help Portal to allow users to generate enrollment links that let them download Worx Home and enroll their devices, or to send themselves an enrollment invitation.

<input type="checkbox"/>	Name	Enabled	Default	Self Help Portal	Expire after	Attempts	PIN length	PIN type	Templates	▼
<input type="checkbox"/>	User name + Password	✓	✓							
<input type="checkbox"/>	High Security	✓			1 day(s)	3	8	numeric		
<input type="checkbox"/>	Invitation URL	✓			1 day(s)					
<input type="checkbox"/>	Invitation URL + PIN	✓			1 day(s)	3	8	numeric		
<input type="checkbox"/>	Invitation URL + Password	✓			1 day(s)	3				
<input type="checkbox"/>	Two Factor	✓			1 day(s)	3	8	numeric		
<input type="checkbox"/>	User name + PIN	✓			1 day(s)	3	8	numeric		

Showing 1 - 7 of 7 items

Choose from these enrollment modes:

- User name + Password
- High Security
- Invitation URL
- Invitation URL + PIN
- Invitation URL + Password
- Two Factor
- User name + PIN

You can use enrollment invitations to restrict enrollment to users with an invitation only.

You can use one-time PIN (OTP) enrollment invitations as a two-factor solution. OTP enrollment invitations control the number of devices a user may enroll.

For environments with the highest security requirements, you can tie enrollment invitations to a device by SN/UDID/EMEI. A two-factor option is also available to require Active Directory password and OTP.

To edit an enrollment mode

1. In the **Enrollment** list, select an enrollment mode and then click **Edit**. The **Edit Enrollment Mode** page appears. Depending on the mode you select, you may see different options.

The screenshot shows the XenMobile interface for editing an enrollment mode. The breadcrumb trail is 'Settings > Enrollment > Edit Enrollment Mode'. The title is 'Edit Enrollment Mode'. The current mode is 'High Security'. The configuration options are:

- Expire after***: 1 Days (with a help icon)
- Maximum attempts***: 3 (with a help icon)
- PIN Length***: 8 Numeric

Under the 'Notification templates' section, there are three dropdown menus:

- Template for enrollment URL: -- SELECT ONE --
- Template for Enrollment PIN: -- SELECT ONE --
- Template for enrollment confirmation: -- SELECT ONE --

At the bottom right, there are 'Cancel' and 'Save' buttons.

2. Change the following information as appropriate:

- **Expire after:** Type an expiration deadline after which users cannot enroll their devices. This value appears in the user and group enrollment invitation configuration pages.
Note: Type 0 to prevent the invitation from expiring.
- **Days:** In the list, click **Days** or **Hours** to correspond to the expiration deadline you entered in **Expire after**.
- **Maximum attempts:** Type the number of attempts to enroll that a user can make before being locked out of the enrollment process. This value appears in the user and group enrollment invitation configuration pages.
Note: Type 0 to allow unlimited attempts.
- **PIN length:** Type a numeral to set the length of the generated PIN.
- **Numeric:** In the list, click **Numeric** or **Alphanumeric** for the PIN type.
- **Notification templates:**
 - **Template for enrollment URL:** In the list, click a template to use for the enrollment URL. For example, the Enrollment invitation template sends users an email or SMS. The method depends on how you configured the template that lets them enroll their devices in XenMobile. For more information on notification templates, see [Creating or updating Notification Templates](#).

- **Template for enrollment PIN:** In the list, click a template to use for the enrollment PIN.
- **Template for enrollment confirmation:** In the list, click a template to use to inform a user that they enrolled successfully.

3. Click **Save**.

To set an enrollment mode as default

When you set an enrollment mode as the default, the mode is used for all device enrollment requests unless you select a different enrollment mode. If no enrollment mode is set as the default, you must create a request for enrollment for each device enrollment.

Note: The only enrollment modes that you can use as a default are **Only Username + Password, Two Factor, or Username + PIN**.

1. Select the default enrollment mode, either **Username + Password, Two Factor, or Username + PIN**.

Note: To use a mode as the default, first enable it.

2. Click **Default**. The selected mode is now the default. If any other enrollment mode was set as the default, the mode is no longer the default.

To disable an enrollment mode

Disabling an enrollment mode makes it unavailable for use, both for group enrollment invitations and on the Self Help Portal. You may change how you allow users to enroll their devices by disabling one enrollment mode and enabling another.

1. Select an enrollment mode.

Note: You cannot disable the default enrollment mode. If you want to disable the default enrollment mode, you must first remove its default status.

2. Click **Disable**. The enrollment mode is no longer enabled.

To enable an enrollment mode on the Self Help Portal

Enabling an enrollment mode on the Self Help Portal lets users enroll their devices in XenMobile individually.

Note:

- The enrollment mode must be enabled and bound to notification templates to be made available on the Self Help Portal.
- You can only enable one enrollment mode on the Self Help Portal at a time.

1. Select an enrollment mode.

2. Click **Self Help Portal**. The enrollment mode you selected is now available to users on the Self Help Portal. Any mode already enabled on the Self Help Portal is no longer available to users.

Adding or removing groups

You manage groups in the **Manage Groups** dialog box in the XenMobile console on these pages: **Users, Add Local User, or Edit Local User**. There is no group edit command.

If you remove a group, keep in mind that removing the group has no effect on user accounts. Removing a group simply removes user association with that group. Users also lose access to apps or profiles provided by the Delivery Groups that are associated with that group; any other group associations, however, remain intact. If users are not associated with any other local groups, they are associated at the top level.

To add a local group

1. Do one of the following:

- On the **Users** page, click **Manage Local Groups**.

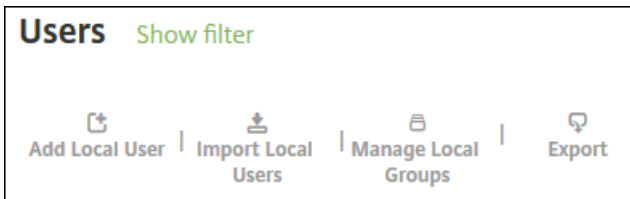

- On either the **Add Local User** page or the **Edit Local User** page, click **Manage Groups**.

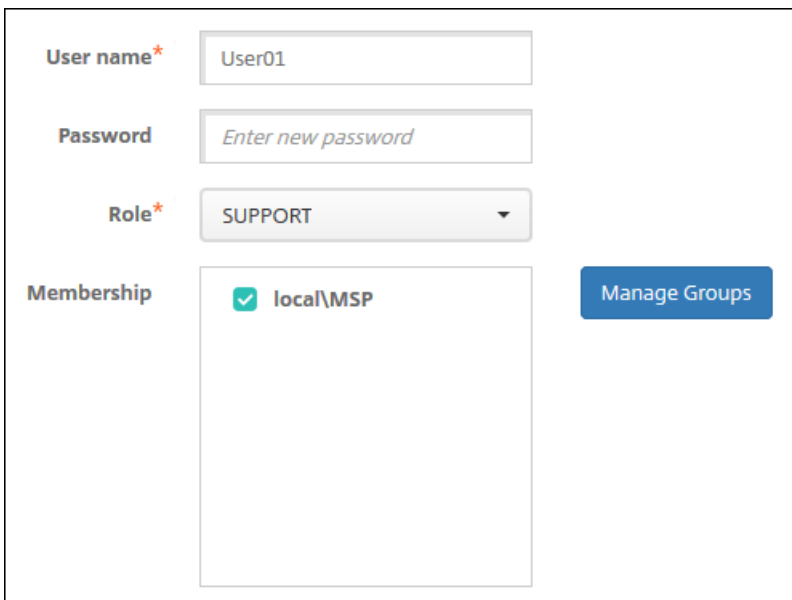
A screenshot of a user management form. It contains four main sections: 'User name*' with a text input field containing 'User01'; 'Password' with a text input field containing the placeholder 'Enter new password'; 'Role*' with a dropdown menu showing 'SUPPORT'; and 'Membership' with a list of groups, where 'local\MSP' is selected with a green checkmark. To the right of the membership list is a blue button labeled 'Manage Groups'.

The **Manage Group** dialog box appears.

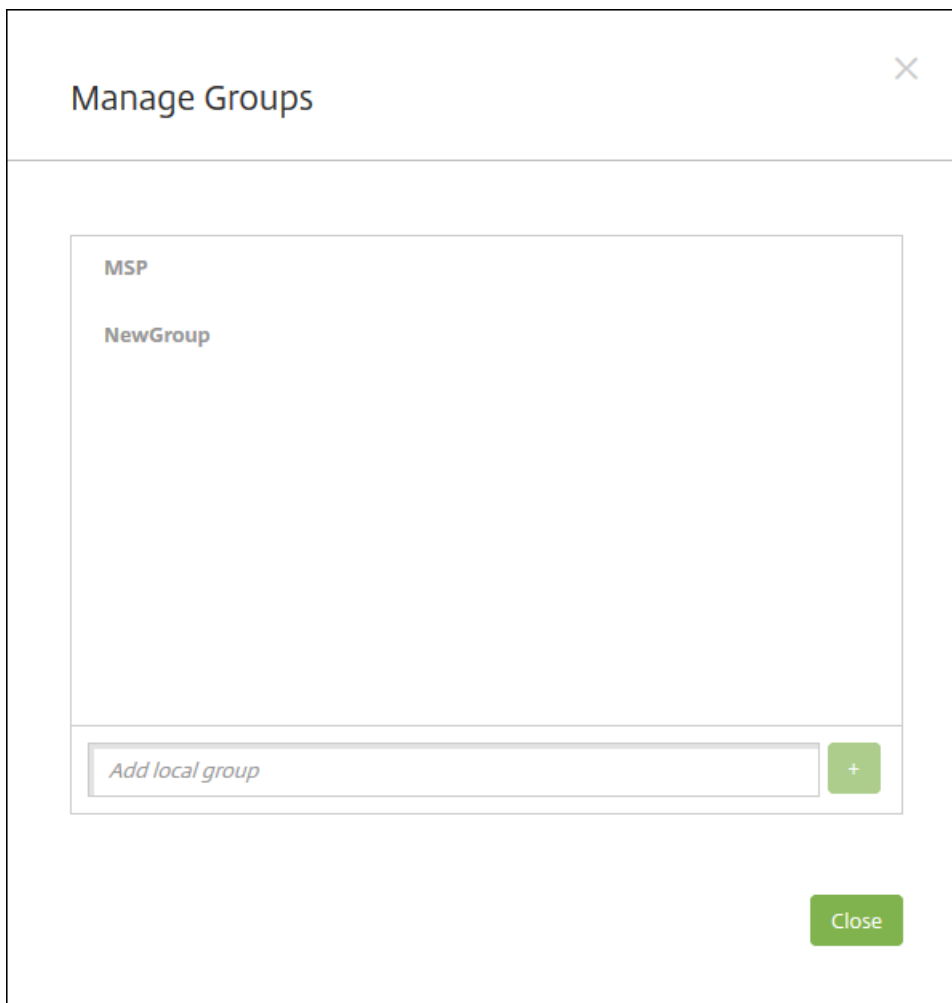

2. Below the group list, type a new group name and then click the plus sign (+). The user group is added to the list.

3. Click **Close**.

To remove a group

Note: Removing a group has no effect on user accounts. Removing a group simply removes the users' association with that group. Users also lose access to apps or profiles provided by the Delivery Groups that are associated with that group; any other group associations, however, remain intact. If users are not associated with any other local groups, they are associated at the top level.

1. Do one of the following:

- On the **Users** page, click **Manage Local Groups**.
- On either the **Add Local User** page or the **Edit Local User** page, click **Manage Groups**.

The **Manage Groups** dialog box appears.

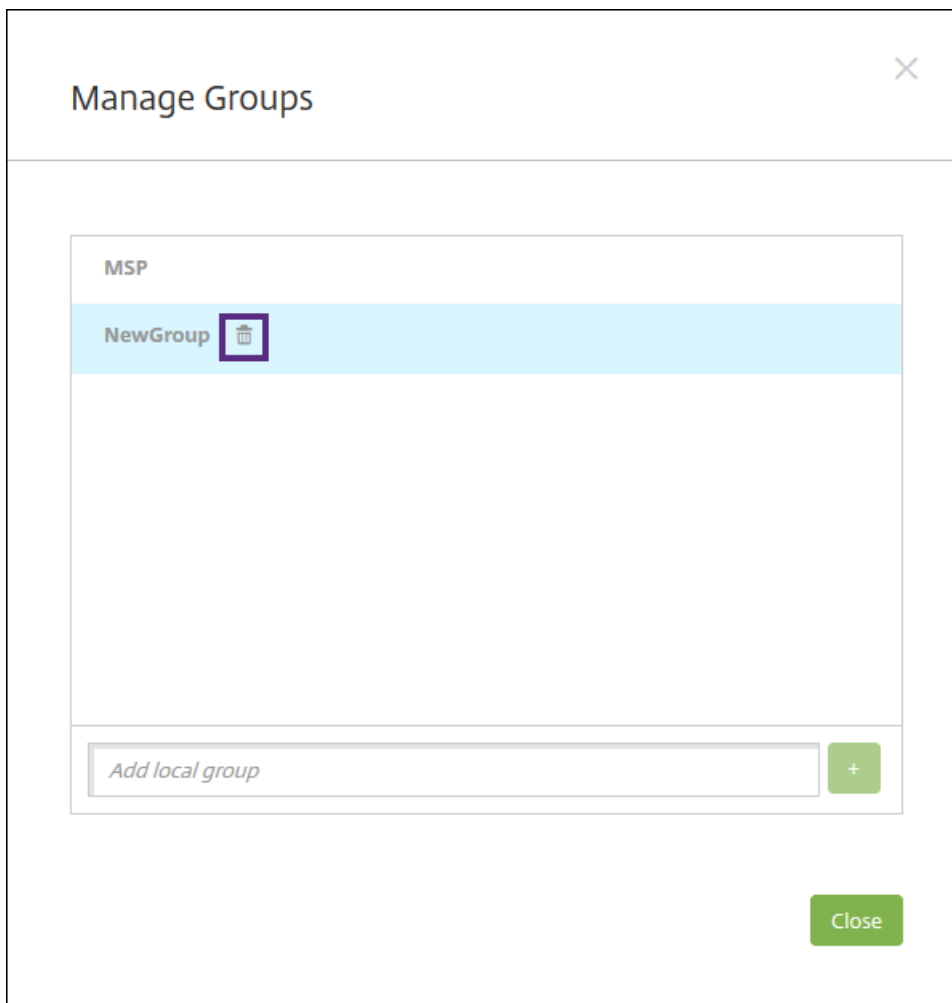

2. On the **Manage Groups** dialog box, click the group you want to delete.
3. Click the trash can icon to the right of the group name. A confirmation dialog box appears.
4. Click **Delete** to confirm the operation and remove the group.

Important: You cannot undo this operation.

5. On the **Manage Groups** dialog box, click **Close**.

Create and manage workflows

You can use workflows to manage the creation and removal of user accounts. Before you can use a workflow, identify individuals in your organization who have the authority to approve user account requests. Then, you can use the workflow template to create and approve user account requests.

When you set up XenMobile for the first time, you configure workflow email settings, which must be set before you can use workflows. You can change workflow email settings at any time. These settings include the email server, port, email address, and whether the request to create the user account requires approval.

You can configure workflows in two places in XenMobile:

- In the **Workflows** page in the XenMobile console. On the **Workflows** page, you can configure multiple workflows for

use with app configurations. When you configure workflows on the Workflows page, you can select the workflow when you configure the app.

- When you configure an application connector in the app, you provide a workflow name and then configure the individuals who can approve the user account request. See [Adding Apps to XenMobile](#).

You can assign up to three levels for manager approval of user accounts. If you need other persons to approve the user account, you can search for and select them by using their name or email address. When XenMobile finds the person, you then add them to the workflow. All individuals in the workflow receive emails to approve or deny the new user account.

1. In the XenMobile console, click the gear icon in the upper-right corner of the console. The **Settings** page appears.
2. Click **Workflows**. The **Workflows** page appears.
3. Click **Add**. The **Add Workflow** page appears.
4. Configure these settings:
 - **Name:** Type a unique name for the workflow.
 - **Description:** Optionally, type a description for the workflow.
 - **Email Approval Templates:** In the list, select the email approval template to be assigned. You create email templates in the **Notification Templates** section under **Settings** in the XenMobile console. When you click the eye icon to the right of this field, you see a preview of the template you are configuring.
 - **Levels of manager approval:** In the list, select the number of levels of manager approval required for this workflow. The default is **1 level**. Possible options are:
 - Not Needed
 - 1 level
 - 2 levels
 - 3 levels
 - **Select Active Directory domain:** In the list, select the appropriate Active Directory domain to be used for the workflow.
 - **Find additional required approvers:** Type a name in the search field and then click **Search**. Names originate in Active Directory.
 - When the name appears in the field, select the check box next to the name. The name and email address appear in the **Selected additional required approvers** list.
 - To remove a name from the list, do one of the following:
 - Click **Search** to see a list of everyone in the selected domain.
 - Type a full or partial name in the search box, and then click **Search** to limit the search results.
 - Persons in the **Selected additional required approvers** list have check marks next to their name in the search results list. Scroll through the list and clear the check box next to each name that you want to remove.
5. Click **Save**. The created workflow appears on the **Workflows** page.

After you create the workflow, you can view the workflow details, view the apps associated with the workflow, or delete the workflow. You cannot edit a workflow after you create the workflow. If you need a workflow with different approval levels or approvers, create another workflow.

To view details and delete a workflow

1. On the **Workflows** page, in the list of existing workflows, select a specific workflow. To do that, click the row in the table or select the check box next to the workflow.

2. To delete a workflow, click **Delete**. A confirmation dialog box appears. Click **Delete** again.

Important: You cannot undo this operation.

Configure roles with RBAC

Jun 28, 2017

Each predefined role-based access control (RBAC) role has certain access and feature permissions associated with the role. This article describes what each of those permissions does. For a full list of default permissions for each built-in role, download [Role-Based Access Control Defaults](#).

When you *apply permissions*, you are defining the user groups the RBAC role has the permission to manage. Note that the default administrator cannot change the applied permission settings; by default, the applied permissions apply to all user groups.

When you make an *assignment*, you are assigning the RBAC role to a group, so that the group of users owns the RBAC administrator rights.

Admin Role



Users with the predefined Admin role have access or do not have access to the following features in XenMobile. By default, **Authorized access** (except Self-Help Portal), **Console features**, and **Apply permissions** are enabled.

Access

Admin console access	Administrators have access to all features on the XenMobile console.
Remote Support access	Administrators own Remote Support access.
Self-Help Portal access	Administrators do not have Self-Help Portal access.
Shared devices enroller	Administrators do not have Shared devices enroller access. This feature is intended for users who need to enroll shared devices.
Public API access	Administrators have access to the public API to perform actions programmatically that are available on the XenMobile console, such as administering certificates, licenses, apps, or local users and groups.

Console features

Administrators have unrestricted access to the XenMobile console.

Dashboard	This is the first page administrators see after logging on to XenMobile. It shows basic information about notifications and devices.
Reporting	On the Analyze page, XenMobile provides pre-defined reports that let you analyze your app and device deployments.

Devices	The Devices page is where administrators manage users' devices. They can add individual devices on the page, or they can import a device provisioning file to add multiple devices at one time.
Local Users and Groups	The Users page is where administrators manage local users and local user groups. They can add, edit, or delete local users and local users groups.
Enrollment	The Enrollment page is where administrators manage how users are invited to enroll their devices in XenMobile.
Policies	The Device Policies page is where administrators manage device polices like VPN and WiFi.
App	The Apps page is where administrators manage the various apps that users can install on their devices.
Smart action	The Actions page is where administrators manage responses to trigger events.
Delivery group	The Delivery Group page is where administrators manage delivery groups and the resources associated with them.
Enrollment profile	On the Settings page, in Enrollment, you configure enrollment profiles (modes) to allow users to enroll their devices.
Setting	The Settings page is where administrators manage system settings like client and server properties.
Support	The Support page is where administrators can run diagnostics, generate logs, or upload support bundles, among other activities.

Device features

Administrators access device features throughout the console by setting device restrictions, setting up and sending notifications to devices, administering apps on the devices, and so on.

Full Wipe device	Erase all data and apps from a device, including memory cards if the device has one.
Clear Restriction	Remove one or more device restriction.
Selective Wipe device	Erase all corporate data and apps from a device, leaving personal data and apps in place.

View locations	See the location of and set geographic restrictions on a device.	
	Locate device.	
	Track device.	
Lock device	Remotely lock a device so that users cannot use the device.	
Unlock device	Remotely unlock a device so that users can use the device.	
Lock container	Remotely lock the corporate container on a device.	
Unlock container	Remotely unlock the corporate container on a device.	
Reset container password	Reset the corporate container password.	
Bypass activation lock	Store a bypass code on a supervised iOS device when Activation Lock is enabled and later use this code to clear Activation Lock automatically should you need to erase the device.	
Rings the device	Remotely ring a Windows device at full volume for 5 minutes.	
Deploy to device	Send apps, notifications, restrictions, and so on to a device.	
Edit device	Change settings on the device.	
Notification to device	Send a notification to a device.	
Add/Delete device	Add or remove devices from XenMobile.	
Devices import	Import a group of devices from a file into XenMobile.	
Export device table	Collect device information from the Device page and export it to a .csv file.	
Revoke device	Prohibit a device from connecting to XenMobile.	
App lock	Deny access to all apps on a device. On Android, users will not be able to log into XenMobile at all. On iOS,	

	users will still be able to log in, but they will be unable to access apps.
App wipe	On Android, this deletes the user's XenMobile account. On iOS, this deletes the encryption key users need to be able to access XenMobile features.
View software inventory	See what software is installed on a device.
Request AirPlay mirroring	Request to start AirPlay streaming.
Stop AirPlay mirroring	Stop AirPlay streaming.
Enable lost mode	On the Manage page, in Devices, you can put a supervised device in lost mode to block a supervised device on the lock screen and locate the device when the device is lost or stolen.
Disable lost mode	On the Manage page, in Devices, you can disable lost mode for a device that is set to lost mode.

App features

Administrators manage various apps on the Apps page in XenMobile.

Add/Delete app store or enterprise app	Add or remove a public app store app or an app not wrapped with the MDX Toolkit.
Edit app store or enterprise app	Make changes to a public app store app or an app not wrapped with the MDX Toolkit.
Add/Delete MDX, Web and SaaS app	Add or remove an app wrapped with the MDX Toolkit (MDX app), an app from your internal network (Web app), or an app from a public network (SaaS) to XenMobile.
Edit MDX, Web and SaaS app	Make changes to an app wrapped with the MDX Toolkit (MDX app), an app from your internal network (Web app), or an app from a public network (SaaS) to XenMobile.
Add/Delete category	Add or delete a category in which apps can appear in the XenMobile Store.
Assign public/enterprise app to delivery group	Assign a public app store app or an app not wrapped with the MDX Toolkit to a delivery group for deployment.

Assign MDX/WebLink/SaaS app to delivery group	Assign an app wrapped with the MDX Toolkit (MDX app), an app that does not require single sign-on (WebLink), or an app from a public network (SaaS) to a delivery group for deployment to users' devices.
Export app table	Collect app information from the App page and export it to a .csv file.

Delivery group

Administrators manage delivery groups from the Delivery Groups page in XenMobile.

Add/delete delivery group	Create or remove a delivery group, which adds specified users and optional policies, apps, and actions.
Edit delivery group	Change an existing delivery group, which modifies users and optional policies, apps, and actions.
Deploy delivery group	Make delivery group available for use.
Export delivery group	Collect delivery group information from the Delivery group page and export it to a .csv file.

Smart action

Administrators can add, delete, edit, assign, and export actions.

Add/delete smart action	Add or remove an action that is defined by a trigger (event, device or user property, or installed app name) and associated response.
Edit smart action	Change an action that is defined by a trigger (event, device or user property, or installed app name) and associated response.
Assign smart action to delivery group	Assign an action to a delivery group for deployment to users' devices.
Export smart action	Collect action information from the Actions page and export it to a .csv file.

Support

Administrators can perform various support tasks.

NetScaler Gateway Connectivity Checks	Perform various connectivity checks for NetScaler Gateway by IP address. Requires a user name and password.
XenMobile Connectivity Checks	Perform connectivity checks for selected XenMobile features, such as database, DNS, Google Plan, and so on.
Create Support Bundles	Create a file that contains system information, logs, database information, core information, trace files, and the latest configuration information for XenMobile or NetScaler Gateway to be sent to Citrix Support for troubleshooting.
Citrix Product Documentation	Access the public Citrix XenMobile documentation site.
Citrix Knowledge Center	Access the Citrix Support site to search for knowledge base articles.
Logs	Access and analyze details for debug, admin audit, and user audit log files.
Cluster Information	Access information about each of the nodes in a clustered environment.
Garbage Collection	Access information about memory objects no longer in use.
Java Memory Properties	Access a snapshot of Java memory usage, memory details, and memory pool details.
Macros	Populate user or device property data within the text field of a profile, policy, notification, or enrollment template. Configure a single policy and deploy the policy to a large user base and have user-specific values appear for each targeted user.
PKI Configuration	Import and export PKI configuration information.
APNS Signing Utility	Submit a request for Apple Push Network signing (APNs) certificates, or upload Secure Mail APNs certificate for iOS.
Citrix Insight Services	Upload logs to Citrix Insight Services (CIS) for assistance with various issues.
Device NetScaler Connector Status	Query XenMobile for the status of a device as sent to XenMobile NetScaler Connector based on the device ActiveSync ID.
Anonymization and de-anonymization	When you create support bundles in XenMobile, sensitive user, server, and network data is made anonymous by default. You can change this behavior on the Anonymization and De-anonymization page in Support under Advanced.

Settings

Administrators configure various settings on the Settings page.

RBAC		
	RBAC Assignment	
LDAP	Administer one or more LDAP-compliant directory, such as Active Directory, to import groups, user accounts, and related properties.	
License	Administer your Citrix licenses.	
Enrollment	Enable enrollment modes for users as well as the Self-Help Portal.	
Release Management	View the current installed release.	
	Release Management Update	
Certificates		
	Edit APNS certificate	
	Certificates SSL Listener	
Notification Templates	Create notification templates to use in automated actions, enrollment, and standard notification message delivery to users.	
Workflows	Manage the creation, approval, and removal of user accounts for use with app configurations.	
Credential Providers	Add one or more credential providers authorized to issue device certificates. The credential providers control the certificate format and the conditions for renewing or revoking the certificate.	
PKI Entities	Manage public key infrastructure entities (generic, Microsoft Certificate Services, or discretionary CA).	

Client Properties	Manage various properties on users' devices, such as passcode type, strength, expiry, and so on.
Secure Hub (Client) Support	Set the ways in which users can contact your support services (email, phone, or support ticket email).
XenMobile Store (Client) Branding	Create a custom store name and default store views for the XenMobile Store, and add a custom logo that appears on XenMobile Store or Secure Home on devices running Receiver for iPhone or Receiver for iPad.
Carrier SMS Gateway	Set up carrier SMS gateways to configure notifications that are sent through carriers' SMS gateways.
Notification Server	Set up a SMTP gateway server to send email to users.
ActiveSync Gateway	Manage user access to users and devices through rules and properties.
Google Play Credentials	Set up user name, password, and device ID to allow access to Google Play.
iOS Device Enrollment	Configure iOS device enrollment through the Apple Device Enrollment Program or by using the Apple Configurator.
iOS/VPP Settings	Add Apple Volume Purchase Program accounts.
Mobile Service Provider	Use the Mobile Service Provider interface to query BlackBerry and other Exchange ActiveSync devices and to issue operations.
NetScaler Gateway	Add a NetScaler Gateway and select whether authentication is enabled, whether to push user certificate for authentication, the identity of the credential provider.
Network Access Control	Set the conditions that determine a device is non-compliant and therefore denied access to the network.
Samsung KNOX	Enable or disable XenMobile to query Samsung KNOX attestation server REST APIs.
Server Properties	Add or modify server properties. Requires restarting XenMobile on all nodes.
Syslog	Send log files to a system log (syslog) server using the server host name or IP address.
XenApp/XenDesktop	Allow users to add XenApp and XenDesktop through Secure Hub.

ShareFile	<p>When using XenMobile with ShareFile Enterprise: Configure settings to connect to the ShareFile account and administrator service account to manage user accounts. Requires existing ShareFile domain and administrator credentials.</p> <p>When using XenMobile with StorageZone Connectors: Configure XenMobile to point to network shares and SharePoint locations defined in ShareFile StorageZones Connectors.</p>
Experience Improvement Program	Opt into or out of sending anonymous statistics and usage information to Citrix.
Microsoft Azure	In Settings, under Server, you can integrate XenMobile with Microsoft Azure.
Android for Work	In Settings, under Server, you can configure Android for Work server settings.

Enrollment

Administrators can add and delete enrollment invitations, send notifications to users, and export the enrollment table to a .csv file.

Add/Delete enrollment	Add or remove an enrollment invitation to a user or a group of users.
Notify user	Send an enrollment invitation to a user or group of users.
Export enrollment invitation table	Collect enrollment information from the Enrollment page and export it to a .csv file.

Policies

Add/Delete policy	Add or remove a device or app policy.
Edit policy	Change a device or app policy.
Upload Policy	Upload a device or app policy.
Clone Policy	Copy a device or app policy.
Disable Policy	Disable an existing app policy.
Export Policy	Collect device policy information from the Device Policies page and export it to a .csv file.

Assign Policy	Assign a device policy to one or more delivery groups.
---------------	--

Restrict Group Access

Admin users can apply permissions to all user groups.

Device Provisioning Role



Important: The Device Provisioning Role applies only to Windows CE devices.

Users with the predefined Device Provisioning role have limited access to console features; by default, their permission is set to all user groups and they cannot change this setting.

Console features

Device provisioning users have the following restricted access to the XenMobile console. By default, each of the following features is enabled.

Device features

Disown device	Remove device ownership of device enrolled in Apple's DEP.
Bypass activation lock	Store a bypass code on a supervised iOS device when Activation Lock is enabled and later use this code to clear Activation Lock automatically should you need to erase the device.
Rings the device	Remotely ring a Windows device at full volume for 5 minutes.
Edit device	Change settings on the device.
Add/Delete device	Add or remove devices from XenMobile.
Request AirPlay Mirroring	Requests use of the AirPlay feature allows users to wirelessly stream content from an iOS device to a TV screen through Apple TV, or to mirror exactly what's on a device display to a TV screen or another Mac computer.
Stop AirPlay Mirroring	Stops use of the AirPlay feature.

Settings

Device provisioning users can access the **Settings** page, but do not have the rights to configure the features.

Support Role



Users with the Support role have access to remote support; their permissions apply to all users by default and they cannot edit this setting.

User Role



Users with the User role have the following limited access to XenMobile.

Authorized access

Self-Help Portal	Users have access only to the Self-Help Portal in XenMobile.
------------------	--

Console features

Users have the following restricted access to the XenMobile console.

Device features

Full Wipe device	Erase all data and apps from a device, including memory cards if the device has one.	
Selective Wipe device	Erase all corporate data and apps from a device, leaving personal data and apps in place.	
View locations	See the location of and set geographic restrictions on a device.	
	Locate device	See the location of a device.
	Track device	Track a device's location over time.
Lock device	Remotely lock a device so that it cannot be used.	
Unlock device	Remotely unlock a device so that it can be used.	
Lock container	Remotely lock the corporate container on a device.	
Unlock container	Remotely unlock the corporate container on a device.	
Reset container password	Reset the corporate container password.	
Disown device	Remove device ownership of device enrolled in the Apple DEP.	

Bypass activation lock	Store a bypass code on a supervised iOS device when Activation Lock is enabled and later use this code to clear Activation Lock automatically should you need to erase the device.
Rings the device	Remotely ring a Windows device at full volume for 5 minutes.
View software inventory	See what software is installed on a device.

Enrollment

Add/Delete enrollment	Add or remove an enrollment invitation to a user or a group of users.
Notify user	Send an enrollment invitation to a user or group of users.

Restrict Group Access

For all four default roles, this permission is set by default and can be applied to all user groups. You cannot edit the role.

Configure roles with RBAC

The Role-Based Access Control (RBAC) feature in XenMobile lets you assign predefined roles, or sets of permissions, to users and groups. These permissions control the level of access users have to system functions.

XenMobile implements four default user roles to logically separate access to system functions:

- **Administrator.** Grants full system access.
- **Device Provisioning.** Grants access to basic device administration for Windows CE devices.
- **Support.** Grants access to remote support.
- **User.** Used by users who can enroll devices and access the Self Help Portal.

You can also use the default roles as templates that you customize to create new user roles with permissions to access specific system functions beyond the functions defined by the default roles.

Roles can be assigned to local users (at the user level) or to Active Directory groups (all users in that group have the same permissions). If a user belongs to several Active Directory groups, all the permissions are merged together to define the permissions for that user. For example, if ADGroupA users can locate manager devices, and ADGroupB users can wipe employee devices, then a user who belongs to both groups can locate and wipe devices of managers and employees.

Note: Local users may have only one role assigned to them.

You can use the RBAC feature in XenMobile to do the following:

- Create a new role.

- Add groups to a role.
- Associate local users to roles.

1. In the XenMobile console, click the gear icon in the upper-right corner of the console. The **Settings** page appears.
2. Click **Role-Based Access Control**. The **Role-Based Access Control** page appears, which displays the four default user roles, plus any roles you have previously added.

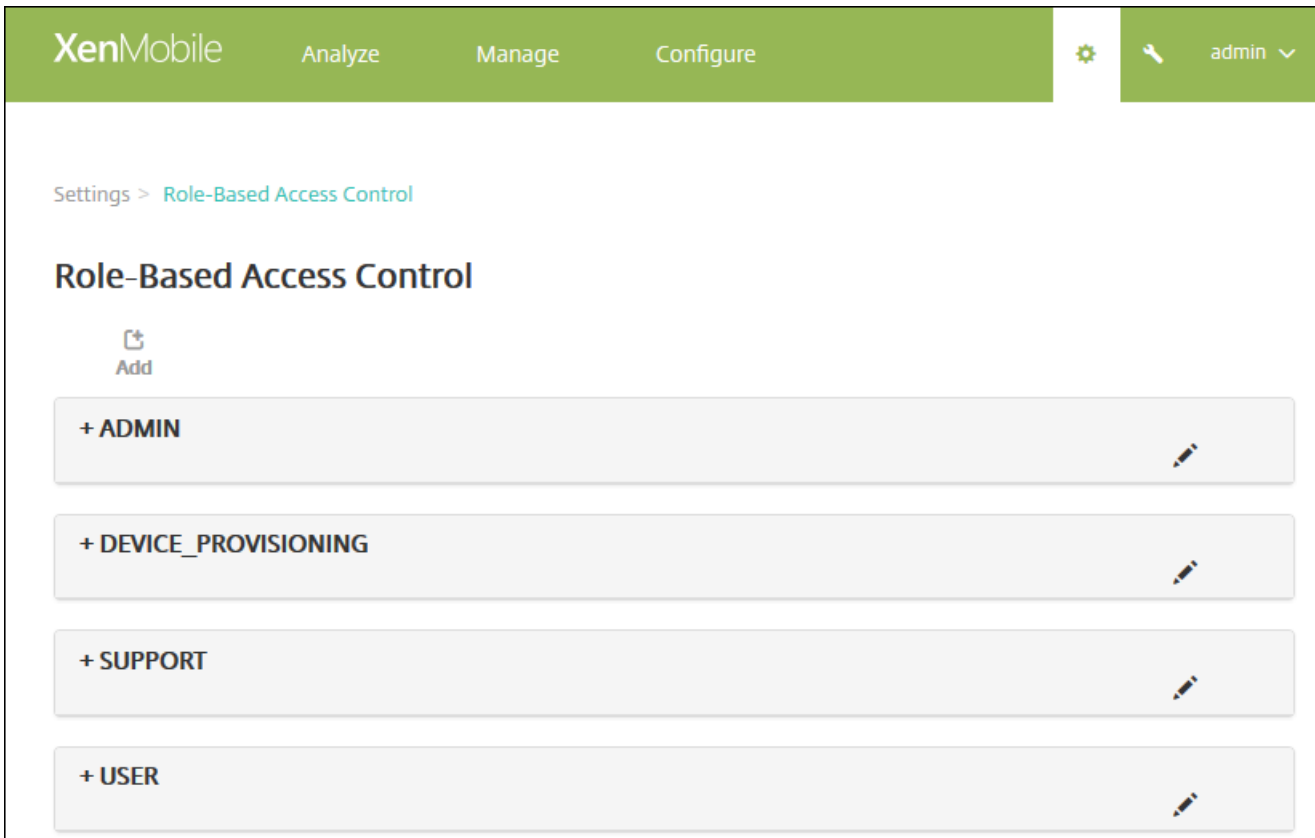

If you click the plus sign (+) next to a role, the role expands to show all the permissions for that role, as shown in the following figure.



3. Click **Add** to add a new user role, click the pen icon to the right of an existing role to edit the role, or click the trash can icon to the right of a role you previously defined to delete the role. You cannot delete the default user roles.

- When you click **Add** or the pen icon, the **Add Role** or the **Edit Role** page appears.
- When you click the trash can icon, a confirmation dialog appears. Click **Delete** to remove the selected role.

4. Enter the following information to create a new user role or to edit an existing user role:

- **RBAC name:** Enter a descriptive name for the new user role. You cannot change the name of an existing role.
- **RBAC template:** Optionally, click a template as the starting point for the new role. You cannot select a template if you are editing an existing role.

RBAC templates are the default user roles. They define the access to system functions that users associated with that role have. After you select an RBAC template, you can see all of the permissions associated with that role in the **Authorized Access** and **Console Features** fields. Using a template is optional; you can directly select the options you want to assign to a role in the **Authorized Access** and **Console Features** fields.

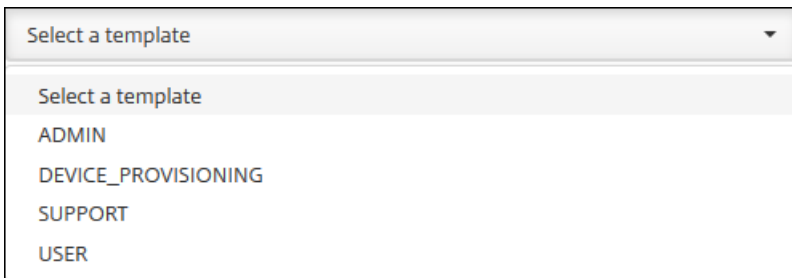

5. Click **Apply** to the right of the **RBAC template** field to populate the **Authorized access** and **Console features** check boxes with the pre-defined access and feature permissions for the selected template.

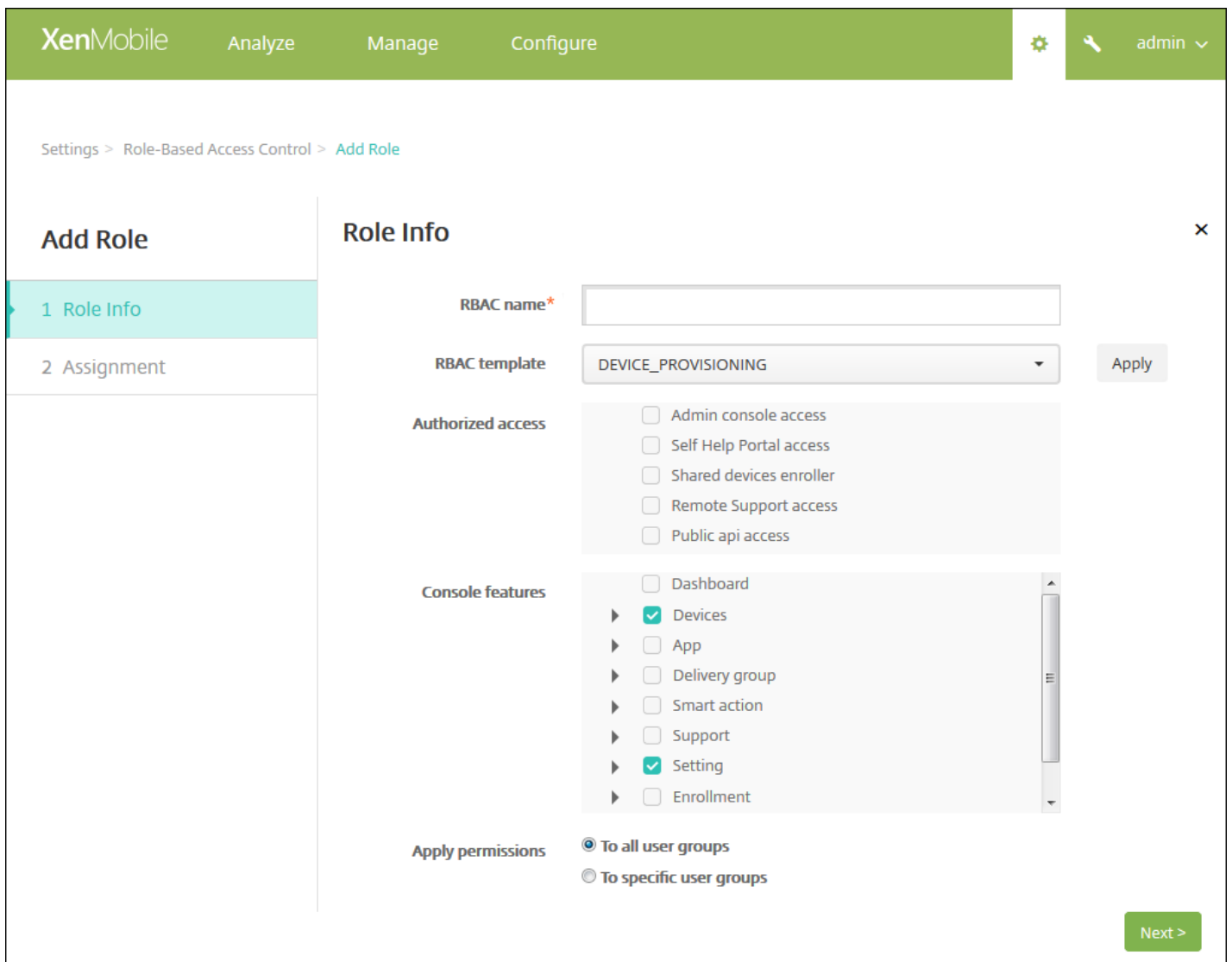

6. Select and clear the check boxes in **Authorized access** and **Console features** to customize the role.

If you click the triangle next to a Console feature, permissions specific to that feature appear that you can select and clear. Clicking the top-level check box prohibits access to that console part; you must select individual options below the top level to enable those options. For example, in the following figure, the **Full Wipe device** and **Clear Restrictions** options do not appear on the console for users assigned to the role, but the checked options do appear.

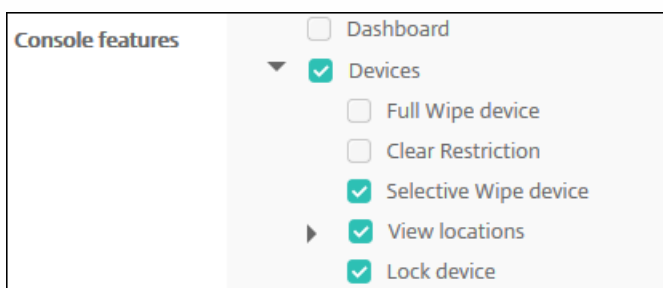

7. **Apply permissions:** Select the groups to which you want to apply the selected permissions. If you click **To specific user groups**, a list of groups appears from which you can select one or more groups.

Apply permissions

To all user groups

To specific user groups

Search for user groups

ActiveDirectory

LocalAdmin

MSP

8. Click **Next**. The **Assignment** page appears.

XenMobile Analyze Manage Configure

Settings > Role-Based Access Control > Add Role

Add Role

1 Role Info

2 Assignment

Assignment

Assign the RBAC role to user groups

Select domain: testprise.net

Include user groups: [Search]

Selected user groups:

Back Save

9. Enter the following information to assign the role to user groups.

- **Select domain:** In the list, click a domain.
- **Include user groups:** Click Search to see a list of all available groups, or type a full or partial group name to limit the list to only groups with that name.
- In the list that appears, select the user groups to which you want to assign the role. When you select a user group, the group appears in the **Selected user groups** list.

XenMobile Analyze Manage Configure admin

Settings > Role-Based Access Control > Add Role

Add Role

- 1 Role Info
- 2 Assignment

Assignment

Assign the RBAC role to user groups

Select domain: testprise.net

Include user groups: user Search

- testprise.net\Remote Desktop Users
- testprise.net\Performance Monitor Users
- testprise.net\Performance Log Users

Selected user groups:

- testprise.net
 - Remote Desktop Users
 - Performance Monitor Users

Back Save

Note: To remove a user group from the **Selected user groups** list, click the X next to the user group name.

10. Click **Save**.

Notifications

Jun 19, 2017

You can use notifications in XenMobile for the following purposes:

- To communicate with select groups of users for a number of system-related functions. You can also target these notifications for certain users. For example, all users with iOS devices, users whose devices are out of compliance, users with employee-owned devices, and so on.
- To enroll users and their devices.
- To automatically notify users (using automated actions) when certain conditions are met. For example:
 - When a user device is about to be blocked from the corporate domain because of a compliance issue.
 - When a device has been jailbroken or rooted.

For details about automated actions, see [Automated Actions](#).

To send notifications with XenMobile, you must configure a gateway and a notification server. You can set up a notification server in XenMobile to configure Simple Mail Transfer Protocol (SMTP) and Short Message Service (SMS) gateway servers to send email and text (SMS) notifications to users. You can use notifications to send messages over two different channels: SMTP or SMS.

- SMTP is a connection-oriented, text-based protocol in which a mail sender communicates with a mail receiver by issuing command strings and supplying necessary data, typically over a Transmission Control Protocol (TCP) connection. SMTP sessions consist of commands originated by an SMTP client (the person sending the message) and corresponding responses from the SMTP server.
- SMS is a text messaging service component of phone, Web, or mobile communication systems. SMS uses standardized communications protocols to enable fixed line or mobile phone devices to exchange short text messages.

You can also set up a Carrier SMS Gateway in XenMobile to configure notifications that are sent through a SMS gateway of a carrier. Carriers use SMS gateways to send or receive SMS transmissions to or from a telecommunications network. These text-based messages use standardized communications protocols to allow fixed line or mobile phone devices to exchange short text messages.

The procedures in this article explain how to configure an [SMTP server](#) and an [SMS gateway](#), and a [carrier SMS gateway](#).

Prerequisites

- Before configuring the SMS gateway, consult your system administrator to determine the server information. It's important to know whether the SMS server is hosted on an internal corporate server, or whether the server is part of a hosted email service. In that case, you need information from the website of the service provider.
- Configure the SMTP notifications server to send messages to users. If the server is hosted on an internal server, contact your system administrator for configuration information. If the server is a hosted email service, locate the appropriate configuration information on the website of the service provider.
- Make sure that only one SMTP server and only one SMS server is active at a time.
- Open port 25 from XenMobile located in your network DMZ to point back to the SMTP server on your internal network. That enables XenMobile to send notifications successfully.

To configure an SMTP server and SMS gateway

1. In the XenMobile console, click the gear icon in the upper-right corner of the console. The **Settings** page appears.

2. Under **Notifications**, click **Notification Server**. The **Notification Server** page appears.

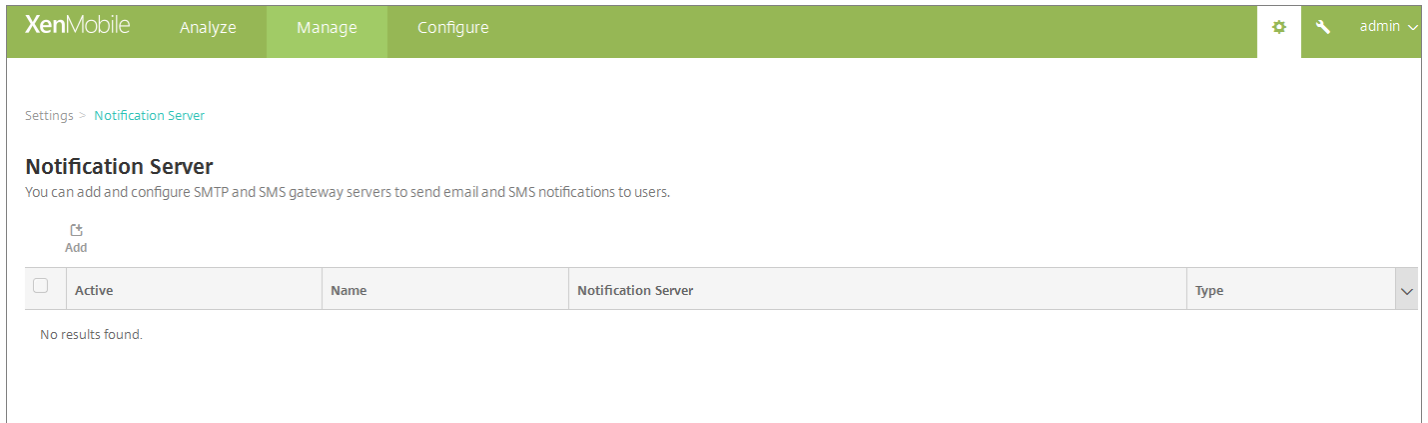

2. Click **Add**. A menu appears with options to configure an SMTP server or an SMS gateway.

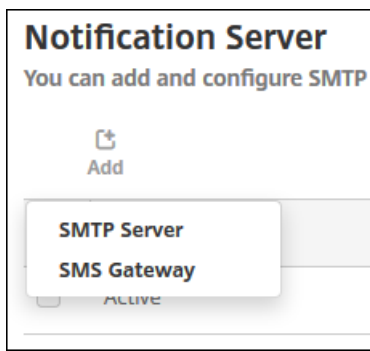

- To add an SMTP server, click **SMTP Server** and then see [To add an SMTP server](#) for the steps to configure this setting.
- To an SMS gateway, click **SMS Gateway** and then see [To add an SMS gateway](#) for the steps to configure this setting.

To add an SMTP server

Settings > Notification Server > Add SMTP Server

Add SMTP Server

You need to configure the SMTP notifications server to send messages to users. If the SMTP server is hosted on an internal server, you get the server information from your IT department. If the server is a hosted email service, you can find information from the service provider's website. Only one SMTP server is activated at one time.

Name*	<input type="text"/>
Description	<input type="text"/>
SMTP Server*	<input type="text"/>
Secure channel protocol	<input type="text" value="None"/>
SMTP server port*	<input type="text" value="25"/>
Authentication	<input type="checkbox" value="OFF"/>
Microsoft Secure Password Authentication (SPA)	<input type="checkbox" value="OFF"/>
From name*	<input type="text"/>
From email*	<input type="text"/>

Test Configuration

▶ Advanced Settings

Cancel

Add

1. Configure these settings:

- **Name:** Type the name associated with this SMTP server account.
- **Description:** Optionally, enter a description of the server.
- **SMTP Server:** Type the host name for the server. The host name may be a fully qualified domain name (FQDN) or an IP address.
- **Secure channel protocol:** In the list, click **SSL, TLS**, or **None** for the secure channel protocol used by the server (if the server is configured to use secure authentication). The default is **None**.
- **SMTP server port:** Type the port used by the SMTP server. By default, the port is set to 25; if SMTP connections use

the SSL secure channel protocol, the port is set to 465.

- **Authentication:** Select **ON** or **OFF**. The default is **OFF**.
- If you enable **Authentication**, configure these settings:
 - **User name:** Type the user name for authentication
 - **Password:** Type the authentication user's password.
- **Microsoft Secure Password Authentication (SPA):** If the SMTP server is using the SPA, click **ON**. The default is **OFF**.
- **From Name:** Type the name displayed in the **From** box when a client receives a notification email from this server. For example, Corporate IT.
- **From email:** Type the email address used if an email recipient replies to the notification sent by the SMTP server.

2. Click **Test Configuration** to send a test email notification.

3. Expand **Advanced Settings** and then configure these settings:

- **Number of SMTP retries:** Type the number of times to retry a failed message sent from the SMTP server. The default is 5.
- **SMTP Timeout:** Type the duration to wait (in seconds) when sending an SMTP request. Increase this value if message sending is continuously failing because of timeouts. Use caution when decreasing this value; it could increase the number of timed out and undelivered messages. The default is 30 seconds.
- **Maximum number of SMTP recipients:** Type the maximum number of recipients per email message sent by the SMTP server. The default is 100.

4. Click **Add**.

To add an SMS gateway

Settings > Notification Server > Add SMS Gateway

Add SMS Gateway

Please consult with your IT department about the server info if the SMS server is hosted on internal corporate server; if this is a hosted email service, the info is available from the service provider's website. Only one SMS server is activated at one time.

Name*	<input type="text"/>
Description	<input type="text"/>
Key*	<input type="text"/>
Secret*	<input type="text"/>
Virtual phone number*	<input type="text"/>
HTTPS	<input type="checkbox"/> OFF
Country code	<input type="text" value="Afghanistan +93"/>
Use Carrier Gateway	<input checked="" type="checkbox"/> ON
	<input type="button" value="Test Configuration"/>

Note

XenMobile only supports Nexmo SMS messaging. If you do not already have an account to use Nexmo messaging, visit their [website](#) to create one.

1. Configure the following settings:

- **Name:** Type a name for the SMS Gateway configuration. This field is required.
- **Description:** Optionally, type a description of the configuration.
- **Key:** Type the numerical identifier provided by the system administrator when activating the account. This field is required.
- **Secret:** Type a secret provided by the system administrator that is used to access your account in the event that a

password is lost or stolen. This field is required.

- **Virtual Phone Number:** This field is used when sending to North American phone numbers (with the +1 prefix). You must type a Nexmo virtual phone number and you must only use digits in this field. You can purchase virtual phone numbers on the Nexmo website.
- **HTTPS:** Select whether to use HTTPS to transmit SMS requests to Nexmo. The default is **OFF**.

Important: Leave HTTPS set to **ON** unless you have guidance from Citrix Support to turn it to **OFF**.

- **Country Code:** In the list, click the default SMS country code prefix for recipients in your organization. This field always starts with a + symbol. The default is **Afghanistan +93**.

2. Click **Test Configuration** to send a test message using the current configuration. Connection errors, such as authentication or virtual phone number errors, are detected and appear immediately. Messages are received in the same time frame as messages sent between mobile phones.

2. Click **Add**.

To add a carrier SMS gateway

You can set up a Carrier SMS Gateway in XenMobile to configure notifications that are sent through a carrier's SMS gateway. Carriers use Short Message Service (SMS) gateways to send or receive SMS transmissions to or from a telecommunications network. These text-based messages use standardized communications protocols to allow fixed line or mobile phone devices to exchange short text messages.

1. In the XenMobile console, click the gear icon in the upper-right corner of the console. The **Settings** page appears.
2. Under **Notifications**, click **Carrier SMS Gateway**. The **Carrier SMS Gateway** page opens.

Settings > Carrier SMS Gateway

Carrier SMS Gateway



Add



Detect

<input type="checkbox"/>	Carrier	SMTP domain	Country code	Sending prefix	▾
<input type="checkbox"/>	Alltel	message.alltel.com	+1		
<input type="checkbox"/>	AT&T	txt.att.net	+1		
<input type="checkbox"/>	Boost Mobile	myboostmobile.com	+1		
<input type="checkbox"/>	Bouygues Telecom	mms.bouyguestelecom.fr	+33		
<input type="checkbox"/>	Cingular	cingularme.com	+1		
<input type="checkbox"/>	Metro PCS	mymetropcs.com	+1		
<input type="checkbox"/>	Nextel	messaging.nextel.com	+1		
<input type="checkbox"/>	Orange	websmsmms.orange.fr	+33		
<input type="checkbox"/>	Powertel	ptel.net	+1		
<input type="checkbox"/>	SFR	sfr.fr	+33		

Showing 1 - 10 of 16 items

Showing 1 of 2



3. Do one of the following:

- Click **Detect** to automatically discover a gateway. A dialog box appears indicating that there are no new carriers detected or listing the new carriers detected among enrolled devices.
- Click **Add**. The **Add a Carrier SMS Gateway** dialog box appears.

Add a Carrier SMS Gateway ✕

Converts email messages passing through the gateway to a pre-defined format, such as an instant message.

Carrier*

Gateway SMTP domain*

Country code*

Email sending prefix

Note: XenMobile only supports Nexmo SMS messaging. If you do not already have an account to use Nexmo messaging, visit their [website](#) to create one.

4. Configure these settings:

- **Carrier:** Type the name of the carrier.
- **Gateway SMTP domain:** Type the domain associated with the SMTP gateway.
- **Country code:** In the list, click the country code for the carrier.
- **Email sending prefix:** Optionally, specify an email sending prefix.

5. Click **Add** to add the new carrier or click **Cancel** to not add the new carrier.

Creating and updating notification templates

You can create or update notification templates in XenMobile to be used in automated actions, enrollment, and standard notification messages sent to users. You configure the notification templates to send messages over three different channels: Secure Hub, SMTP, or SMS.

XenMobile includes many predefined notification templates that reflect the distinct types of events that XenMobile automatically responds to for every device in the system.

Note: If you plan to use SMTP or SMS channels to send notifications to users, you must set up the channels before you

can activate them. XenMobile prompts you to set up the channels when you add notification templates if they are not already set up.

1. In the XenMobile console, click the gear icon in the upper-right corner of the console. The **Settings** page appears.
2. Click **Notification Templates**. The **Notification Templates** page appears.

Settings > Notification Templates

Notification Templates

Create notification templates to use in automated actions, enrollment, and standard notification message delivery to users.

Add

<input type="checkbox"/>	Name	Channels	Type	Deletable	Manual sending supported	▼
<input type="checkbox"/>	ActiveSync Gateway Blocked	Worx Home	ActiveSync Gateway blocked device			
<input type="checkbox"/>	Android Download Link	SMTP, SMS	Android Download Link			
<input type="checkbox"/>	APNS cert expiration	SMTP	APNS Cert Expiration			
<input type="checkbox"/>	Certificate renewal	Worx Home	Certificate is renewed			
<input type="checkbox"/>	Enrollment	SMTP, SMS	Enrollment Notification			
<input type="checkbox"/>	Enrollment Confirmation	SMTP, SMS	Enrollment Confirmation			
<input type="checkbox"/>	Enrollment Invitation	SMTP, SMS	Enrollment Invitation			
<input type="checkbox"/>	Enrollment PIN	SMTP, SMS	Enrollment PIN			
<input type="checkbox"/>	Failed Samsung KNOX attestation	Worx Home	Failed Samsung KNOX attestation			
<input type="checkbox"/>	iOS Download Link	SMTP, SMS	iOS Download Link			

Showing 1 - 10 of 25 items

Showing 1 of 3

To add a notification template

1. Click **Add**. If no SMS gateway or SMTP server has been set up, a message appears regarding the use of SMS and SMTP notifications. You can choose to set up the SMTP server or SMS gateway now or set them up later.

If you choose to set up SMS or SMTP server settings now, you are redirected to the **Notification Server** page on the **Settings** page. After setting up the channels you want to use, you can return to the **Notification Template** page to continue adding or modifying notification templates.

Important

If you choose to set up SMS or SMTP server settings later, you will not be able to activate those channels when you add or edit a notification template, which means those channels will not be available for sending user notifications.

2. Configure these settings:

- **Name:** Type a descriptive name for the template.
- **Description:** Type a description for the template.
- **Type:** In the list, click the notification type. Only supported channels for the selected type appear. Only one APNS Cert Expiration template is allowed, which is a predefined template. This means you cannot add a new template of this type.

Note: For some template types, the phrase Manual sending supported appears below the type. This means that the template is available in the **Notifications** list on the **Dashboard** and on the **Devices** page to let you manually send the notification to users. Manual sending is not available in any template that uses the following macros in the Subject or Message field on any channel:

- `${outofcompliance.reason(whitelist_blacklist_apps_name)}`
- `${outofcompliance.reason(smog_block)}`

3. Under **Channels**, configure the information for each channel to be used with this notification. You can choose any or all channels. The channels you choose depends on how you want to send notifications:

- If you choose **Secure Hub**, only iOS and Android devices receive the notifications, which appear in the device's notification tray.
- If you choose **SMTP**, most users should receive the message because they will have enrolled with their email addresses.
- If you choose **SMS**, only users using devices with a SIM card receive the notification.

Secure Hub:

- **Activate:** Click to enable the notification channel.
- **Message:** Type the message to be sent to the user. This field is required if you are using Secure Hub. For information about using macros in a message, see [Macros](#).
- **Sound File:** In the list, click the notification sound the user hears when the notification is received.

SMTP:

- **Activate:** Click to enable the notification channel.

Important: You are only able to activate the SMTP notification if you have already set up the SMTP server.

- **Sender:** Type an optional sender for the notification, which can be a name, an email address, or both.
- **Recipient:** This field contains a pre-built macro for all but Ad-Hoc notifications to ensure that notifications are sent to the correct SMTP recipient address. Citrix recommends that you do not modify macros in templates. You can also add recipients (for example, the corporate administrator), in addition to the user by adding their addresses separated by a semi-colon (;). To send Ad Hoc notifications, you can enter specific recipients on this page, or you can select devices from the **Manage > Devices** page and send notifications from there. For details, see [Devices](#).
- **Subject:** Type a descriptive subject for the notification. This field is required.
- **Message:** Type the message to be sent to the user. For information about using macros in a message, see [Macros](#).

SMS:

- **Activate:** Click to enable the notification channel.

Important: You are only able to activate the SMS notification if you have already set up the SMS gateway.

- **Recipient:** This field contains a pre-built macro for all but Ad-Hoc notifications to ensure that notifications are sent to the correct SMS recipient address. Citrix recommends that you do not modify macros in templates. To send Ad Hoc notifications, you can enter specific recipients, or you can select devices from the **Manage > Devices** page.
- **Message:** Type the message to be sent to the user. This field is required. For information about using macros in a message, see [Macros](#).

5. Click **Add**. When all channels are correctly configured, they appear in this order on the **Notification Templates** page: SMTP, SMS, and Secure Hub. Any channels not correctly configured appear after the correctly configured channels.

To edit a notification template

1. Select a notification template. The edit page specific to that template appears where you can make changes to all but the **Type** field, as well as activate or deactivate channels.
2. Click **Save**.

To delete a notification template

Note: You can delete only notification templates that you have added; you cannot delete predefined notification templates.

1. Select an existing notification template.
2. Click **Delete**. A confirmation dialog box appears.
2. Click **Delete** to delete the notification template or click **Cancel** to cancel deleting the notification template.

Devices

Jul 21, 2017

The XenMobile server database stores a list of mobile devices. A unique serial number or International Mobile Station Equipment Identity (IMEI)/Mobile Equipment Identifier (MEID) uniquely defines each mobile device. To populate the XenMobile console with your devices, you can add the devices manually or you can import a list of devices from a file. See [Device provisioning file formats](#), for information about device provisioning file formats.

The **Devices** page in the XenMobile console lists each device and the following information:

- **Status** (icons indicate whether the device is jailbroken, is managed, whether Active Sync Gateway is available, and the deployment state)
- **Mode** (whether the device mode is MDM, MAM, or both)
- Other information about the device, such as **User name**, **Device platform**, **Operating system version**, **Device model**, **Last access**, and **Inactivity days**. Those headings are the defaults shown.

To customize the **Devices** table, click the down arrow on the last heading. Then, select the additional headings you want to see in the table or clear any headings to remove.

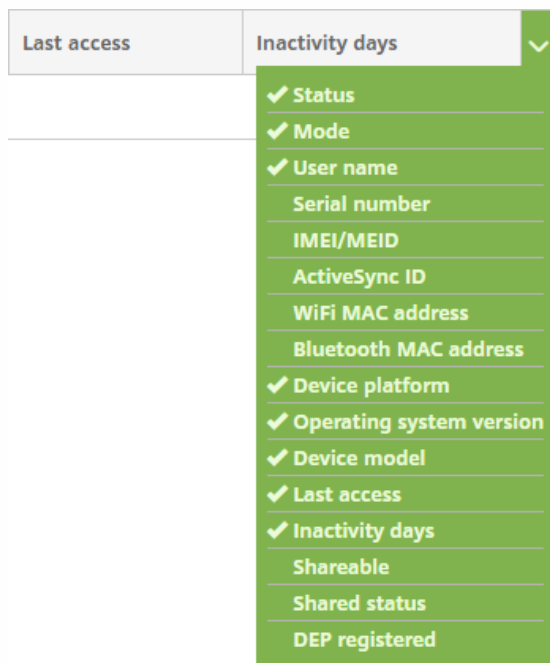

You can add devices manually, import devices from a device provisioning file, edit device details, perform security actions, and send notifications to devices. You can also export all device table data to a .csv file to create a custom report. The server exports all device attributes. If you apply filters, XenMobile uses the filters when creating the .csv file.

See the following sections for details about managing devices:

- [Add a device manually](#)
- [Import devices from a device provisioning file](#)
- [Perform security actions](#)
- [Send a notification to devices](#)

- [Export the Devices table](#)
- [Tag user devices manually](#)
- [Device provisioning file formats](#)
- [Device property names and values](#)

Add a device manually

1. In the XenMobile console, click **Manage > Devices**. The **Devices** page appears.

Status	Mode	User name	Device platform	Operating system version
<input type="checkbox"/>	MDM MAM	us1user1@...net "us1 user1"	Android	5.0.2
<input type="checkbox"/>	MDM MAM	us3user3@...net "us3 user3"	iOS	8.4.1

2. Click **Add**. The **Add Device** page appears.

3. Configure these settings:

- **Select platform:** Click either **iOS** or **Android**.
- **Serial Number:** Type the device serial number.
- **IMEI/MEID:** Optionally, for Android devices only, type the device IMEI/MEID information.

4. Click **Add**. The **Devices** table appears with the device added to the bottom of the list. Choose the device you added and then in the menu that appears, click **Edit** to view and confirm the device details.

Note: When you select the check box next to a device, the options menu appears above the device list. When you click anywhere else in the list, the options menu appears on the right side of the listing.

- XenMobile Server configured in Enterprise (XME) or MDM mode
- LDAP configured
- If using local groups and local users:
 - One or more local groups.

- Local users assigned to local groups.
- Delivery groups are associated with local groups.
- If using Active Directory:
 - Delivery groups are associated with Active Directory groups.

The screenshot shows the XenMobile console interface. At the top, there are navigation tabs: 'XenMobile', 'Analyze', 'Manage', and 'Configure'. The 'Manage' tab is active. Below the navigation, there are sub-tabs: 'Devices', 'Users', and 'Enrollment Invitations'. The 'Devices' sub-tab is selected, and a 'Device details' modal window is open. The modal has a close button (X) in the top right corner. On the left side of the modal, there is a sidebar with a list of categories: 1 General (selected), 2 Properties, 3 Assigned Policies, 4 Apps, 5 Actions, 6 Delivery Groups, 7 iOS Profiles, 8 iOS Provisioning Profiles, 9 Certificates, and 10 Connections. The main content area of the modal is divided into two sections: 'General Identifiers' and 'Security'. The 'General Identifiers' section contains the following information:

Serial Number	A123
IMEI/MEID	NONE
ActiveSync ID	NONE
WiFi MAC Address	NONE
Bluetooth MAC Address	NONE
Device Ownership	<input type="radio"/> Corporate <input type="radio"/> BYOD

The 'Security' section contains the following information:

Strong ID	QYD7UUSF
Full Wipe of Device	No device wipe.
Selective Wipe of Device	No device selective wipe.
Lock Device	No device lock.
Device locate	Locate was requested at 03/01/2017 10:19:02 am. This operation is carried out upon device connection.
Device App Wipe	No device App Wipe.
Device App Lock	No device App Lock.

5. The **General** page lists device **Identifiers**, such as the serial number, ActiveSync ID, and other information for the platform type. For **Device Ownership**, select **Corporate** or **BYOD**.

The **General** page also lists device **Security** properties, such as Strong ID, Lock Device, Activation Lock Bypass, and other information for the platform type.

6. The **Properties** page lists the device properties that XenMobile is to provision. This list shows any device properties included in the provisioning file used to add the device. To add a property, click **Add** and then select a property from the list. For valid values for each property, see [Device property names and values](#) in this article.

When you add a property, it initially appears under the category where you added it. After you click **Next** and then return to the **Properties** page, the property appears in the appropriate list.

To delete a property, hover over the listing and then click the **X** on the right side. XenMobile deletes the item immediately.

7. The remaining **Device Details** sections contain summary information for the device.

- **Assigned Policies:** Displays the number of assigned policies including the number of deployed, pending, and failed policies. Provides the policy name, type and last deployed information for each policy.
- **Apps:** Displays, for the last inventory, the number of installed, pending, and failed apps. Provides the app name, identifier, type, and other information.
- **Actions:** Displays the number of deployed, pending, and failed actions. Provides the action name and time of the last deployment.
- **Delivery Groups:** Displays the number of successful, pending, and failed delivery groups. For each deployment, provides the delivery group name and deployment time. Select a delivery group to view more detailed information, including status, action, and channel or user.
- **iOS Profiles:** Displays the last iOS profile inventory, including name, type, organization, and description.
- **iOS Provisioning Profiles:** Displays enterprise distribution provisioning profile information, such as the UUID, expiration date, and whether it is managed.
- **Certificates:** Displays, for valid, expired, or revoked certificates, information such as the type, provider, issuer, serial number, and the number of remaining days before expiration.
- **Connections:** Displays the first connection status and the last connection status. Provides for each connection, the user name, penultimate (next to last) authentication time, and last authentication time.
- **TouchDown (Android devices only):** Displays information about the last device authentication and the last user authenticated. Provides each applicable policy name and policy value.

Import devices from a provisioning file

You can import a file supplied by mobile operators or device manufacturers, or you can create your own device provisioning file. For more information, see [Device provisioning file formats](#) in this article.

1. Go to **Manage > Devices** and click **Import**. The **Import Provisioning File** dialog box appears.

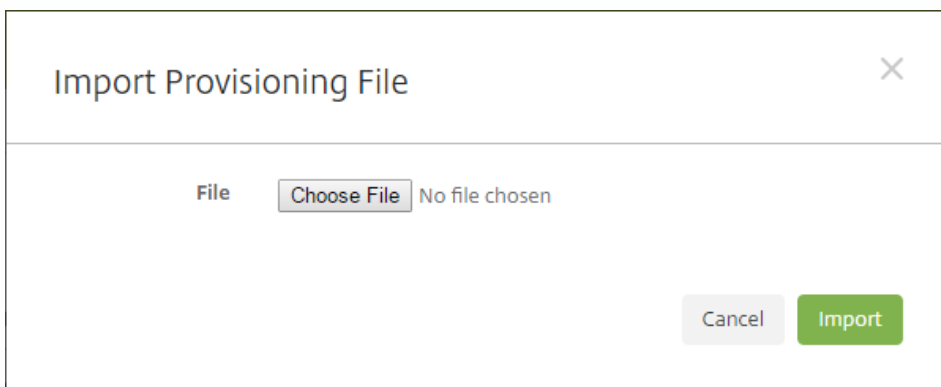

2. Click **Choose File** and then navigate to the file you want to import.

3. Click **Import**. The **Devices** table lists the imported file.

4. To edit the device information, select it and then click **Edit**. For information about the **Device details** pages, see [Add a device manually](#).

Send a notification to devices

You can send notifications to devices from the Devices page. For more information about notifications, see [Notifications](#).

1. On the **Manage > Devices** page, elect the device or devices to which you want to send a notification.
2. Click **Notify**. The **Notification** dialog box appears. The **Recipients** field lists all devices to receive the notification.

The screenshot shows a 'Notification' dialog box with the following fields and options:

- Recipients:** CMVVXKX06J6A
- Templates:** Ad Hoc
- Channels:** SMTP SMS
- SMTP Tab:**
 - Sender:** [Input field]
 - Subject:** [Input field]
 - Message:** [Text area]
- Buttons:** Cancel, Notify

3. Configure these settings:

- **Templates:** In the list, click the type of notification you want to send. For each template except for **Ad Hoc**, the **Subject** and **Message** fields show the text configured for the template that you choose.
- **Channels:** Select how to send the message. The default is **SMTP** and **SMS**. Click the tabs to see the message format for each channel.
- **Sender:** Enter an optional sender.
- **Subject:** Enter a subject for an **Ad Hoc** message.
- **Message:** Enter the message for an **Ad Hoc** message.

4. Click **Notify**.

Export the Devices table

1. Filter the **Devices** table according to what you want to appear in the export file.
2. Click the **Export** button above the **Devices** table. XenMobile extracts the information in the filtered **Devices** table and converts it to a .csv file.
3. When prompted, open or save the .csv file.

Tag user devices manually

You can manually tag a device in XenMobile in the following ways:

- During the invitation-based enrollment process.
- During the Self Help Portal enrollment process.
- By adding device ownership as a device property

You have the option of tagging the device as either corporate- or employee-owned. When using the Self Help Portal to self-enroll a device, you can tag the device as corporate- or employee-owned. You can also tag a device manually, as follows.

1. Add a property to the device from the **Devices** tab in the XenMobile console.
2. Add the property named **Owned by** and choose either **Corporate** or **BYOD** (employee-owned).

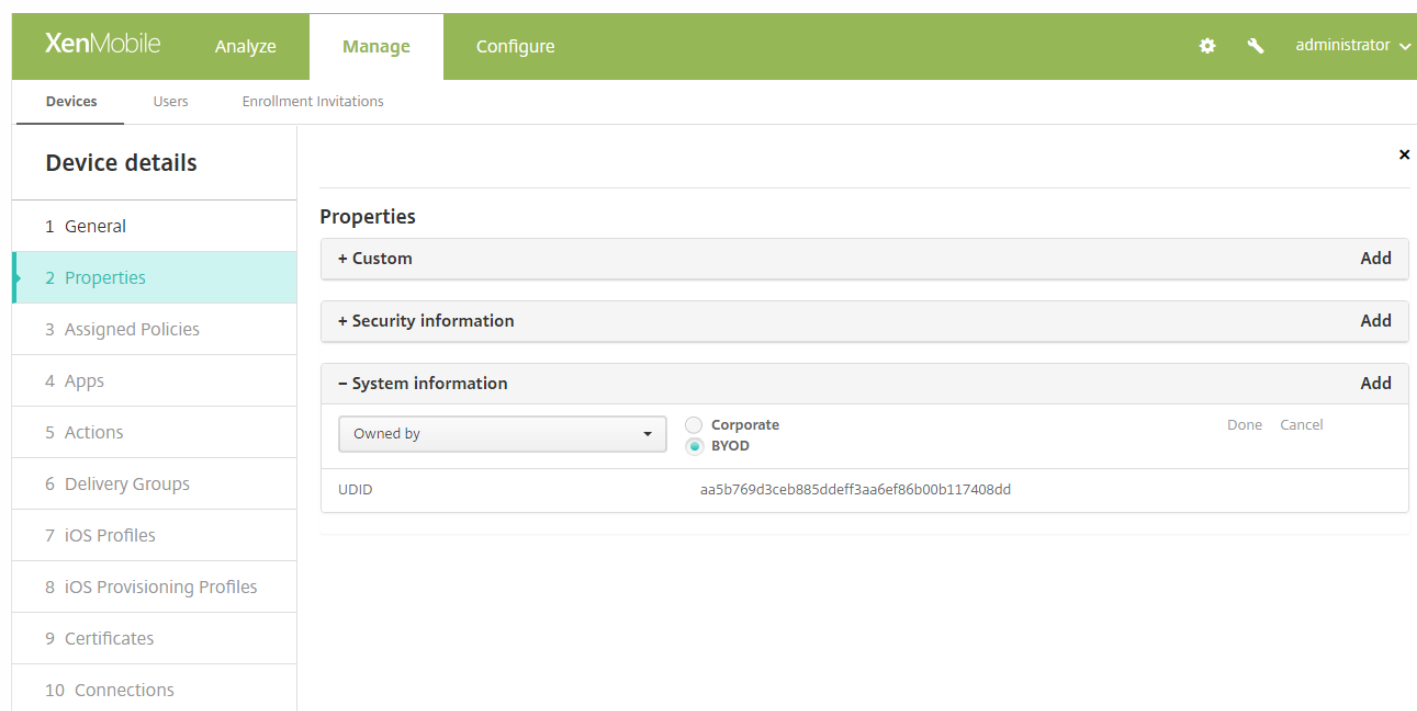

The screenshot shows the XenMobile console interface. The top navigation bar includes 'XenMobile', 'Analyze', 'Manage', and 'Configure'. The user is logged in as 'administrator'. The 'Devices' tab is selected, and the 'Device details' page is open. The left sidebar lists various device management options, with '2 Properties' highlighted. The main content area shows the 'Properties' section for a device, with the 'Owned by' property set to 'BYOD' (employee-owned). The UDID is displayed as aa5b769d3ceb885ddef3aa6ef86b00b117408dd.

Device provisioning file formats

Many mobile operators or device manufacturers provide lists of authorized mobile devices. You can use these lists to avoid having to enter a long list of mobile devices manually. XenMobile supports an import file format that is common to all three supported device types: Android, iOS, and Windows.

A provisioning file that you create manually and use to import devices to XenMobile must be in the following format:

```
SerialNumber;IMEI;OperatingSystemFamily;propertyName1;propertyValue1;propertyName2;propertyValue2; ...  
propertyNameN;propertyValueN
```

Notes:

- For property names and values, see "Device property names and values" in the next section.
- Use the UTF-8 character set.

- Use a semi-colon (;) to separate the fields within the provisioning file. If part of a field contains a semi-colon, escape it with a backslash character (\).

For example, for this property:

```
propertyV;test;1;2
```

Escape it as follows:

```
propertyV\;test\;1\;2
```

- The serial number is required for iOS devices because the serial number is the iOS device identifier.
- For other device platforms, you must include either the serial number or the IMEI.
- Valid values for **OperatingSystemFamily** are **WINDOWS**, **ANDROID**, or **iOS**.

Example of a device provisioning file

COPY

```
1050BF3F517301081610065510590391;15244201625379901;WINDOWS;propertyN;propertyV\;test\;1\;2;prop 2

2050BF3F517301081610065510590392;25244201625379902;ANDROID;propertyN;propertyV$*&&ééétest

3050BF3F517301081610065510590393;35244201625379903;iOS;test;

4050BF3F517301081610065510590393;;iOS;test;

;55244201625379903;ANDROID;test.testé;value;
```

Each line in the file describes a device. The first entry in the above sample means the following:

- SerialNumber: 1050BF3F517301081610065510590391
- IMEI: 15244201625379901
- OperatingSystemFamily: WINDOWS
- PropertyName: propertyN
- PropertyValue: propertyV\;test\;1\;2;prop 2

Device property names and values

Property name in Manage > Devices page	Name and values for device provisioning file	Value type
AIK Present?	WINDOWS_HAS_AIK_PRESENT	String
Account Suspended?	GOOGLE_AW_DIRECTORY_SUSPENDED	String

Activation lock bypass code	ACTIVATION_LOCK_BYPASS_CODE	String
Activation lock enabled	ACTIVATION_LOCK_ENABLED Values (meaning): 1 (Yes) 0 (No)	Boolean
Active iTunes account	ACTIVE_ITUNES Values (meaning): 1 (Yes) 0 (No)	Boolean
ActiveSync ID	EXCHANGE_ACTIVESYNC_ID	String
ActiveSync device known by MSP	AS_DEVICE_KNOWN_BY_ZMSP Values (meaning): 1 (True) 0 (False)	Boolean
Administrator disabled	ADMIN_DISABLED Values (meaning): 1 (Yes) 0 (No)	Boolean
Amazon MDM API available	AMAZON_MDM Values (meaning): 1 (True) 0 (False)	Boolean
Android for Work Device ID	GOOGLE_AW_DEVICE_ID	String
Android for Work Enabled Device?	GOOGLE_AW_ENABLED_DEVICE	String
Android for Work Install Type	GOOGLE_AW_INSTALL_TYPE Values: DeviceAdministrator (Device Owner) AvengerManagedProfile (Work Managed Device) ManagedProfile (Work Profile)	String

Antispyware Signature Status (Windows 10)	ANTI_SPYWARE_SIGNATURE_STATUS	Boolean
Antispyware Status (Windows 10)	ANTI_SPYWARE_STATUS	Boolean
Antivirus Signature Status (Windows 10)	ANTI_VIRUS_SIGNATURE_STATUS Values: Not recent version Most recent version N/A	String
Antivirus Status (Windows 10)	ANTI_VIRUS_STATUS Values: ON and monitoring Disabled OFF or not monitoring Temporarily not monitoring N/A	String
Asset tag	ASSET_TAG	String
Autoupdate Status	AUTOUPDATE_STATUS	String
Available RAM	MEMORY_AVAILABLE	Integer
Available storage space	TOTAL_DISK_SPACE	Integer
BIOS Info	BIOS_INFO	String
Backup battery	BACKUP_BATTERY_PERCENT	Integer
Baseband firmware version	MODEM_FIRMWARE_VERSION	String
Battery Status	BATTERY_STATUS	String
Battery charging (Windows 8.1 Phone)	BATTERY_CHARGING Values (meaning): 1 (True)	Boolean

	0 (False)	
Battery Charging (Windows 10)	BATTERY_CHARGING_STATUS Values (meaning): 1 (True) 0 (False)	Boolean
Battery Remaining (Windows 10)	BATTERY_ESTIMATED_CHARGE_REMAINING	Integer
Bes device known by MSP	BES_DEVICE_KNOWN_BY_ZMSP Values (meaning): 1 (True) 0 (False)	Boolean
BES PIN	BES_PIN	String
BES server agent ID	ENROLLMENT_AGENT_ID	String
BES server name	BES_SERVER	String
BES server version	BES_VERSION	String
Bit Locker Status	WINDOWS_HAS_BIT_LOCKER_STATUS	String
Bluetooth MAC address	BLUETOOTH_MAC	String
Boot Debugging Enabled?	WINDOWS_HAS_BOOT_DEBUGGING_ENABLED	String
Boot Manager Rev List Version	WINDOWS_HAS_BOOT_MGR_REV_LIST_VERSION	String
CPU clock speed	CPU_CLOCK_SPEED	Integer
CPU type	CPU_TYPE	String
Carrier settings version	CARRIER_SETTINGS_VERSION	String
Cellular latitude	GPS_LATITUDE_FROM_CELLULAR	String

Cellular longitude	GPS_LONGITUDE_FROM_CELLULAR	String
Cellular technology	CELLULAR_TECHNOLOGY	Integer
Cellular timestamp	GPS_TIMESTAMP_FROM_CELLULAR	Date
Change Password at Next Login?	GOOGLE_AW_DIRECTORY_CHANGE_PASSWORD_NEXT_LOGIN	String
Client device ID	CLIENT_DEVICE_ID	String
Cloud backup enabled	CLOUD_BACKUP_ENABLED Values (meaning): 1 (Yes) 0 (No)	Boolean
Code Integrity Enabled?	WINDOWS_HAS_CODE_INTEGRITY_ENABLED	String
Code Integrity Rev List Version	WINDOWS_HAS_CODE_INTGTY_REV_LIST_VERSION	String
Color	COLOR	String
Creation Time	GOOGLE_AW_DIRECTORY_CREATION_TIME	String
Current carrier network	CURRENT_CARRIER_NETWORK	String
Current mobile country code	CURRENT_MCC	Integer
Current mobile network code	CURRENT_MNC	String
DEP account name	BULK_ENROLLMENT_DEP_ACCOUNT_NAME	String
DEP Policy	WINDOWS_HAS_DEP_POLICY	String
Data roaming allowed	DATA_ROAMING_ENABLED Values (meaning): 1 (Yes) 0 (No)	Boolean

Date of the last iCloud backup	LAST_CLOUD_BACKUP_DATE	Date
Description	DESCRIPTION	String
Device Enrollment Program profile assigned	PROFILE_ASSIGN_TIME	Date
Device Enrollment Program profile pushed	PROFILE_PUSH_TIME	Date
Device Enrollment Program profile removed	PROFILE_REMOVE_TIME	Date
Device Enrollment Program registration by	DEVICE_ASSIGNED_BY	String
Device Enrollment Program registration date	DEVICE_ASSIGNED_DATE	Date
Device Type	DEVICE_TYPE	String
Device model	MODEL_ID	String
Device name	DEVICE_NAME	String
Do Not Disturb activated	DO_NOT_DISTURB Values (meaning): 1 (Yes) 0 (No)	Boolean
ELAM Driver Loaded?	WINDOWS_HAS_ELAM_DRIVER_LOADED	String
Encryption Compliance (Windows 10)	ENCRYPTION_COMPLIANCE Values: Encrypted Not Encrypted	String
ENROLLMENT_KEY_GENERATION_DATE	ENROLLMENT_KEY_GENERATION_DATE	Date
Enterprise ID	ENTERPRISE_ID	String

External storage 1: available space	EXTERNAL_STORAGE1_FREE_SPACE	Integer
External storage 1: name	EXTERNAL_STORAGE1_NAME	String
External storage 1: total space	EXTERNAL_STORAGE1_TOTAL_SPACE	Integer
External storage 2: available space	EXTERNAL_STORAGE2_FREE_SPACE	Integer
External storage 2: name	EXTERNAL_STORAGE2_NAME	String
External storage 2: total space	EXTERNAL_STORAGE2_TOTAL_SPACE	Integer
External storage encrypted	EXTERNAL_ENCRYPTION Values (meaning): 1 (Yes) 0 (No)	Boolean
Firewall Status (Windows 8.1 Phone)	FIREWALL_STATUS	String
Firewall Status (Windows 10)	DEVICE_FIREWALL_STATUS Values: On and monitoring Disabled Off or not monitoring Temporarily not monitoring N/A	String
Firmware version	FIRMWARE_VERSION	String
First synchronization	ZMSP_FIRST_SYNC	Date
GPS altitude	GPS_ALTITUDE_FROM_GPS	String
GPS latitude	GPS_LATITUDE_FROM_GPS	String
GPS longitude	GPS_LONGITUDE_FROM_GPS	String
GPS timestamp	GPS_TIMESTAMP_FROM_GPS	Date

Google Directory Alias	GOOGLE_AW_DIRECTORY_GOOGLE_ALIAS	String
Google Directory Family Name	GOOGLE_AW_DIRECTORY_FAMILY_NAME	String
Google Directory Name	GOOGLE_AW_DIRECTORY_NAME	String
Google Directory Primary Email	GOOGLE_AW_DIRECTORY_PRIMARY	String
Google Directory User ID	GOOGLE_AW_DIRECTORY_USER_ID	String
HAS_CONTAINER	HAS_CONTAINER Values (meaning): 1 (Yes) 0 (No)	Boolean
HTC API version	HTC_MDM_VERSION	String
HTC MDM API available	HTC_MDM Values (meaning): 1 (Yes) 0 (No)	Boolean
Hardware encryption capabilities	HARDWARE_ENCRYPTION_CAPS	Integer
Hash of the iTunes store account currently logged on	ITUNES_STORE_ACCOUNT_HASH	String
Home carrier network	SIM_CARRIER_NETWORK	String
Home mobile country code	SIM_MCC	Integer
Home mobile network code	SIM_MNC	String
ICCID	ICCID	String
IMEI/MEID number	IMEI	String
IMSI	IMSI	String

IP location	IP_LOCATION	String
Identity	AS_DEVICE_IDENTITY	String
Internal storage encrypted	LOCAL_ENCRYPTION Values (meaning): 1 (True) 0 (False)	Boolean
IPV4 Address (Windows 10)	IP_ADDRESSV4	String
IPV6 Address (Windows 10)	IP_ADDRESSV6	String
Issued At	WINDOWS_HAS_ISSUED_AT	String
Jailbroken/Rooted	ROOT_ACCESS Values (meaning): 1 (Yes) 0 (No)	Boolean
Kernel Debugging Enabled?	WINDOWS_HAS_OS_KERNEL_DEBUGGING_ENABLED	String
Kiosk mode	IS_KIOSK Values (meaning): 1 (True) 0 (False)	Boolean
Last known IP address	LAST_IP_ADDR	String
Last policy update time	LAST_POLICY_UPDATE_TIME	Date
Last synchronization	ZMSP_LAST_SYNC	Date
Locator service enabled	DEVICE_LOCATOR Values (meaning): 1 (Yes)	Boolean

	0 (No)	
MAC Address Network Connection (Windows 10)	MAC_NETWORK_CONNECTION Values (meaning): 1 (Yes) 0 (No)	Boolean
MAC Address Type (Windows 10)	MAC_ADDRESS_TYPE Values: Unknown LAN WLAN	String
MDX_SHARED_ENCRYPTION_KEY	MDX_SHARED_ENCRYPTION_KEY	String
MEID	MEID	String
Mailbox Setup	GOOGLE_AW_DIRECTORY_MAILBOX_SETUP	String
Main battery	MAIN_BATTERY_PERCENT	Integer
Mobile phone number	TEL_NUMBER	String
Model ID	SYSTEM_OEM	String
Network Adapter Type	NETWORK_ADAPTER_TYPE	String
NitroDesk TouchDown installed	TOUCHDOWN_FIND Values (meaning): 1 (True) 0 (False)	Boolean
NitroDesk TouchDown licensed via MDM	TOUCHDOWN_LICENSED_VIA_MDM Values (meaning): 1 (True) 0 (False)	Boolean
Operating system build	SYSTEM_OS_BUILD	String

Operating System Edition (Windows 10)	OS_EDITION	String
Operating system language (locale)	SYSTEM_LANGUAGE	String
Operating system version	SYSTEM_OS_VERSION	String
Organization address	ORGANIZATION_ADDRESS	String
Organization e-mail	ORGANIZATION_EMAIL	String
Organization magic	ORGANIZATION_MAGIC	String
Organization name	ORGANIZATION_NAME	String
Organization phone number	ORGANIZATION_PHONE	String
Other	OTHER	String
Out of Compliance	OUT_OF_COMPLIANCE Values (meaning): 1 (True) 0 (False)	Boolean
Owned by	CORPORATE_OWNED Values (meaning): 1 (Corporate) 0 (BYOD)	Boolean
PCRO	WINDOWS_HAS_PCRO	String
PIN code for geofence	PIN_CODE_FOR_GEO_FENCE	String
Passcode compliant	PASSCODE_IS_COMPLIANT Values (meaning): 1 (Yes) 0 (No)	Boolean
Passcode compliant with configuration	PASSCODE_IS_COMPLIANT_WITH_CFG	Boolean

	<p>Values (meaning): 1 (Yes) 0 (No)</p>	
Passcode present	<p>PASSCODE_PRESENT</p> <p>Values (meaning): 1 (Yes) 0 (No)</p>	Boolean
Perimeter breach	<p>GPS_PERIMETER_BREACH</p> <p>Values (meaning): 1 (Yes) 0 (No)</p>	Boolean
Personal Hotspot activated	<p>PERSONAL_HOTSPOT_ENABLED</p> <p>Values (meaning): 1 (Yes) 0 (No)</p>	Boolean
Platform	<p>SYSTEM_PLATFORM</p>	String
Platform API level	<p>API_LEVEL</p>	Integer
Policy name	<p>POLICY_NAME</p>	String
Primary Phone Number	<p>IDENTITY1_PHONENUMBER</p>	String
Primary SIM Carrier Operator (Windows 10)	<p>IDENTITY1_CARRIER_NETWORK_OPERATOR</p>	String
Primary SIM ICCID (Windows 10)	<p>IDENTITY1_ICCID</p>	String
Primary SIM IMEI	<p>IDENTITY1_IMEI</p>	String
Primary SIM IMSI	<p>IDENTITY1_IMSI</p>	String
Primary SIM Roaming	<p>IDENTITY1_ROAMING</p> <p>Values (meaning): 1 (True)</p>	Boolean

	0 (False)	
Primary SIM Roaming Compliance (Windows 10)	IDENTITY1_ROAMING_COMPLIANCE Values (meaning): 1 (True) 0 (False)	Boolean
Product name	PRODUCT_NAME	String
Publisher Device ID	PUBLISHER_DEVICE_ID	String
Reset Count	WINDOWS_HAS_RESET_COUNT	String
Restart Count	WINDOWS_HAS_RESTART_COUNT	String
SBCP Hash	WINDOWS_HAS_SBCP_HASH	String
SMS capable	IS_SMS_CAPABLE Values (meaning): 1 (True) 0 (False)	Boolean
Safe Mode Enabled?	WINDOWS_HAS_SAFE_MODE	String
Samsung KNOX API available	SAMSUNG_KNOX Values (meaning): 1 (True) 0 (False)	Boolean
Samsung KNOX API version	SAMSUNG_KNOX_VERSION	String
Samsung KNOX attestation	SAMSUNG_KNOX_ATTESTED Values (meaning): 1 (Passed) 0 (Failed)	Boolean
Samsung KNOX attestation updated date	SAMSUNG_KNOX_ATT_UPDATED_TIME	Date

Samsung SAFE API available	SAMSUNG_MDM Values (meaning): 1 (True) 0 (False)	Boolean
Samsung SAFE API version	SAMSUNG_MDM_VERSION	String
Screen: X-axis resolution	SCREEN_XDPI	Integer (PPI)
Screen: Y-axis resolution	SCREEN_YDPI	Integer (PPI)
Screen: height	SCREEN_HEIGHT	Integer (pixels)
Screen: number of colors	SCREEN_NB_COLORS	Integer
Screen: size	SCREEN_SIZE	Decimal (inches)
Screen: width	SCREEN_WIDTH	Integer (pixels)
Secondary Phone Number	IDENTITY2_PHONENUMBER	String
Secondary SIM IMEI	IDENTITY2_IMEI	String
Secondary SIM IMSI	IDENTITY2_IMSI	String
Secondary SIM Roaming	IDENTITY2_ROAMING Values (meaning): 1 (True) 0 (False)	Boolean
Secure Boot Enabled? (Windows 8.1 Phone)	WINDOWS_HAS_SECURE_BOOT_ENABLED	String
Secure Boot Status (Windows 10)	SECURE_BOOT_STATE	String

	<p>Values: Not supported Enabled Disabled</p>	
SecureContainer Enabled	WINDOWS_HAS_BIT_LOCKER_STATUS	String
Serial number	SERIAL_NUMBER	String
Sony Enterprise API available	<p>SONY_MDM</p> <p>Values (meaning): 1 (True) 0 (False)</p>	Boolean
Sony Enterprise API version	SONY_MDM_VERSION	String
Supervised	<p>Supervised</p> <p>Values (meaning): 1 (Yes) 0 (No)</p>	Boolean
Suspension Reason	GOOGLE_AW_DIRECTORY_SUSPENSION_REASON	String
Tampered Status	TAMPERED_STATUS	String
Terms & Conditions	TERMS_AND_CONDITIONS	String
Terms And Agreement Accepted?	GOOGLE_AW_DIRECTORY_AGREED_TO_TERMS	String
Test Signing Enabled?	WINDOWS_HAS_TEST_SIGNING_ENABLED	String
Total RAM	MEMORY	Integer
Total storage space	FREEDISK	Integer
TPM Version (Windows 10)	TPM_VERSION	String
UDID	UDID	String

User Account Control Status (Windows 10)	UAC_STATUS Values: Not Supported Enabled Disabled	String
User agent	USER_AGENT	String
User defined #1	USER_DEFINED_1	String
User defined #2	USER_DEFINED_2	String
User defined #3	USER_DEFINED_3	String
User language (locale)	USER_LANGUAGE	String
VSM Enabled?	WINDOWS_HAS_VSM_ENABLED	String
Vendor	VENDOR	String
Voice capable	IS_VOICE_CAPABLE Values (meaning): 1 (True) 0 (False)	Boolean
Voice roaming allowed	VOICE_ROAMING_ENABLED Values (meaning): 1 (Yes) 0 (No)	Boolean
WINDOWS_ENROLLMENT_KEY	WINDOWS_ENROLLMENT_KEY	String
WNS Notification Status	WNS_PUSH_STATUS	String
WNS Notification URL	PROPERTY_WNS_PUSH_URL	String
WNS Notification URL expiry date	PROPERTY_WNS_PUSH_URL_EXPIRY	String
WiFi MAC address	WIFI_MAC	String

WinPE Enabled?	WINDOWS_HAS_WINPE	String
XenMobile agent ID	AGENT_ID	String
XenMobile agent revision	EW_REVISION	String
XenMobile agent version	EW_VERSION	String

ActiveSync Gateway

Jun 19, 2017

ActiveSync is a mobile data synchronization protocol developed by Microsoft. ActiveSync synchronizes data with handheld devices and desktop (or laptop) computers.

You can configure ActiveSync Gateway rules in XenMobile. Based on these rules, you can allow or deny devices access to ActiveSync data. For example, if you activate the rule Missing Required Apps, XenMobile checks the App Access Policy for required apps and denies access to ActiveSync data if the required apps are missing. For each rule, you can choose either **Allow** or **Deny**. The default setting is **Allow**.

For more information about the App Access device policy, see [App access device policies](#).

XenMobile supports the following rules:

Anonymous Devices: Checks if a device is in anonymous mode. This check is available if XenMobile can't re-authenticate the user when a device attempts to reconnect.

Failed Samsung KNOX attestation: Checks if a device failed a query of the Samsung KNOX attestation server.

Forbidden Apps: Checks if a device has forbidden apps, as defined in an App Access policy.

Implicit Allow and Deny: This action is the default for the ActiveSync Gateway. The gateway creates a Device List of all devices that do not meet any of the other filter rule criteria and allows or denies connections based on that list. If no rule matches, the default is Implicit Allow.

Inactive Devices: Checks if a device is inactive as defined by the Device Inactivity Days Threshold setting in Server Properties.

Missing Required Apps: Checks if a device is missing required apps, as defined in an App Access policy.

Non-suggested Apps: Checks if a device has non-suggested apps, as defined in an App Access policy.

Noncompliant Password: Checks if the user password is compliant. On iOS and Android devices, XenMobile can determine whether the password currently on the device is compliant with the passcode policy sent to the device. For instance, on iOS, the user has 60 minutes to set a password if XenMobile sends a passcode policy to the device. Before the user sets the password, the passcode might be non-compliant.

Out of Compliance Devices: Checks whether a device is out of compliance, based on the Out of Compliance device property. That property is usually changed by the automated actions or by a 3rd party leveraging XenMobile APIs.

Revoked Status: Checks whether the device certificate was revoked. A revoked device cannot re-enroll until it is authorized again.

Rooted Android and jailbroken iOS Devices: Checks whether an Android or iOS device is jailbroken.

Unmanaged Devices: Check whether a device is still in a managed state, under XenMobile control. For example, a device running in MAM mode or an un-enrolled device is not managed.

Send Android domain users to ActiveSync Gateway: Click **YES** to ensure that XenMobile sends Android device information to the ActiveSync Gateway.

To configure the ActiveSync Gateway settings

1. In the XenMobile console, click the gear icon in the upper-right corner. The **Settings** page appears.
2. Under **Server**, click **ActiveSync Gateway**. The **ActiveSync Gateway** page appears.

The screenshot shows the XenMobile console interface. At the top, there is a navigation bar with 'XenMobile', 'Analyze', 'Manage', and 'Configure' tabs. On the right, there is a gear icon and a user profile 'admin'. Below the navigation bar, the breadcrumb 'Settings > ActiveSync Gateway' is visible. The main heading is 'ActiveSync Gateway' with a sub-heading 'Allows or denies access to devices and users based on rules and properties.' Underneath, there is a section for 'All devices' with the instruction 'Activate the following rule(s)'. A list of 13 rules is provided, each with an unchecked checkbox: Anonymous Devices, Failed Samsung KNOX attestation, Forbidden Apps, Implicit Allow and Deny, Inactive Devices, Missing Required Apps, Non-Suggested Apps, Noncompliant Password, Out of Compliance Devices, Revoked Status, Rooted Android and Jailbroken iOS Devices, and Unmanaged Devices. Below this, there is an 'Android only' section with a toggle switch for 'Send Android domain users to ActiveSync Gateway' set to 'YES'. At the bottom right, there are 'Cancel' and 'Save' buttons.

3. In **Activate the following rules**, select one or more rules you want to activate.
4. In **Android-only**, in **Send Android domain users to ActiveSync Gateway**, click **YES** to ensure that XenMobile sends Android device information to the ActiveSync Gateway.
5. Click **Save**.

Android at Work

Jun 19, 2017

Android at Work (formerly called Android for Work) is a secure workspace available on Android devices running Android 5.0 and later. The workspace isolates business accounts, apps, and data from personal accounts, apps, and data. In XenMobile, you manage both bring your own device (BYOD) and company-owned Android devices by having user create a separate work profile on their devices. By combining hardware encryption and the policies you deploy, you securely separate the corporate and personal areas on a device. You can remotely manage or wipe all corporate policies, apps, and data without affecting the personal area of the user. For more information about supported Android devices, see the [Google Android Enterprise](#) website.

You use Google Play to add, buy, and approve apps for deployment to the Android at Work workspace on a device. You can use Google Play to deploy your private Android apps, in addition to public and third-party apps. When you add a paid public app store app to XenMobile for an Android at Work, you can review the Bulk Purchase licensing status. That status is the total number of licenses available, the number now in use, and the email address of each user consuming the licenses. For details about adding an app to XenMobile, see [To add a public app store app to XenMobile](#).

Requirements for Android at Work:

- A publicly accessible domain
- A Google administrator account
- Devices that have managed profile support and that are running Android 5.0+ Lollipop
- A Google account that has Google Play installed
- A Work profile set up on the device

Before you can set Android at Work app restrictions, you must do the following:

- Complete Android at Work setup tasks on Google.
- Create a set of Google Play Credentials.
- Configure Android at Work server settings.
- Create at least one Android at Work device policy.
- Add, buy, and approve Android at Work apps in the Google Play app store.

You can use the following links when managing Android at Work:

- Google admin console: <https://admin.google.com/AdminHome>
- Google Play admin console: <https://play.google.com/work/apps>
- Google Play Publish for private channel and self-hosted applications: <https://play.google.com/apps/publish>
- Google Developer Console for creating a service account: <https://console.developers.google.com>

Android at Work Prerequisites

Before you can administer Android in XenMobile, you must

- Create an Android at Work account.
- Set up a service account.
- Download an Android for Work certificate.
- Enable and authorize the Google Admin SDK and MDM APIs.
- Authorize your service account to use the directory and Google Play.
- Obtain a binding token.

The following sections describe how to do each of these tasks. After you have completed these tasks, you can create a set of Google Play Credentials, configure Android settings, and manage Android apps in XenMobile. For details about creating a set of credentials, see [Google Play Credentials](#).

Create an Android at Work Account

Meet the following prerequisites before you can set up an Android at Work account:

- Own a domain name; for example, example.com.
- Let Google verify that you own the domain.
- Enable and administer Android at Work through an enterprise mobility management (EMM) provider, such as XenMobile 10.1 or later.

If you have already verified your domain name with Google, you can skip to this step: [Set up an Android at Work service account and download an Android at Work certificate](#).

1. Navigate to https://www.google.com/a/signup/?enterprise_product=ANDROID_WORK.

The following page displays where you type your administrator and company information.

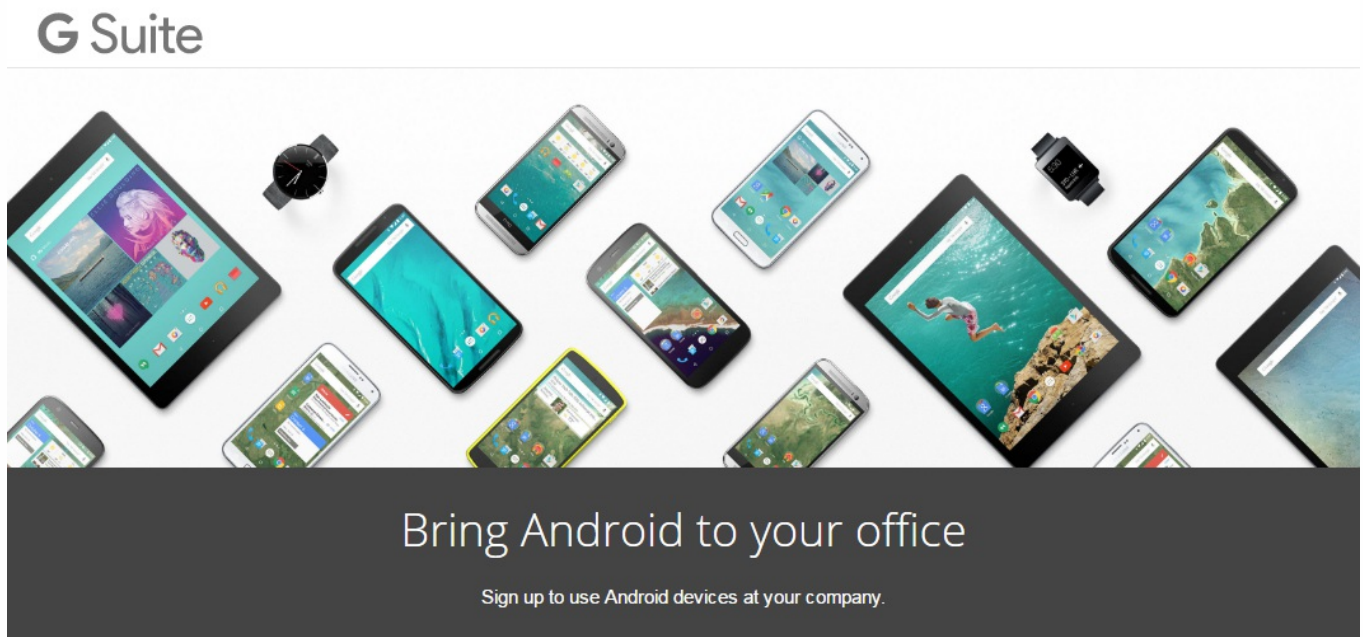

① About you

Name

Current work email

Doesn't have to be an official business email.

Phone

2. Type your administrator user information.

① About you

Name

 ✓ ✓

Current work email

 ✓

Phone

 ✓

2. Type your company information, in addition to your administrator account information.

2 About your business

Business name

 ✓

Business domain address You'll need to verify that you own this domain.

 ✓

Number of employees Country/Region

1 employee United States

3 Your Google admin account Why do I need this?

Username Create an account to manage Android for Work

 ✓ @

Create a password 8-character minimum; case sensitive

 ✓

✓

The first step in the process is complete and you see the following page.



Bring Android to your office

With Android, you can manage your company's devices and keep them secure.



Create your domain admin account



Verify domain ownership

Verify you're the owner of your company's domain and protect its security.

START



Connect with your provider

Allow an enterprise mobility management (EMM) provider to keep your organization's devices secure.

Verify domain ownership

Allow Google to verify your domain in one of the following ways:

- Add a TXT or CNAME record to the website of your domain host.
- Upload an HTML file to the web server of your domain.
- Add a <meta> tag to your home page. Google recommends the first method. This article does not cover the steps to verify your domain ownership, but you can find the information you need here: <https://support.google.com/a/answer/6095407/>.

1. Click **Start** to begin the verification of your domain.

The **Verify domain ownership** page displays. Follow the instructions on the page to verify your domain.

2. Click **Verify**.

Verify domain ownership

Before you can use Google Apps with domain **example.com**, we need to contact your domain host to verify that you own it. Doing this helps ensure that no one can pose as you on Google Apps and send email from your domain. [Learn more](#)

After your domain is verified, we will set up Google Apps email for your users on **example.com**. This will automatically re-route your emails to Google Apps. [Learn more](#)

We have detected that **example.com** is hosted at **GoDaddy.com**. If you're having trouble, try to [verify your domain here](#).

Note: Before you route email to Google Apps, make sure that you create a user on Google Apps for each person receiving mail at **example.com**.

Verify domain ownership

Verification checklist

Follow these steps to help Google verify that you own the domain **example.com**.

[Learn more](#)

- I have successfully logged in.
- I have opened the control panel for my domain.
- I have created the CNAME record.
- I have saved the CNAME record.

[VERIFY](#)

3. Google verifies your domain ownership.

Verify domain ownership

Verifying your domain ownership

The domain host is updating your information. This might take a bit—you can close this window and come back to admin.google.com later without interrupting the process.

[Learn more](#)

Estimated time remaining: 5 minutes

4. After successful verification, the following page displays. Click **Continue**.

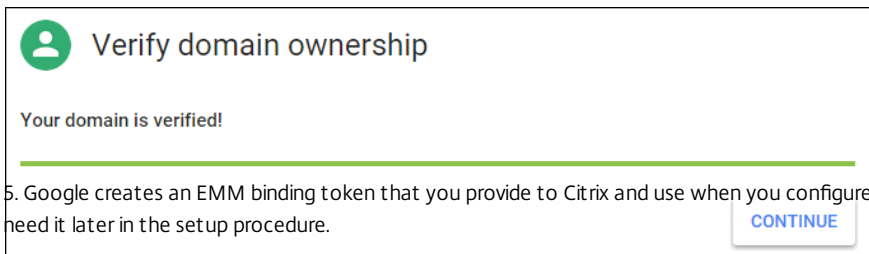

Verify domain ownership

Your domain is verified!

5. Google creates an EMM binding token that you provide to Citrix and use when you configure Android at Work settings. Copy and save the token; you need it later in the setup procedure.

[CONTINUE](#)

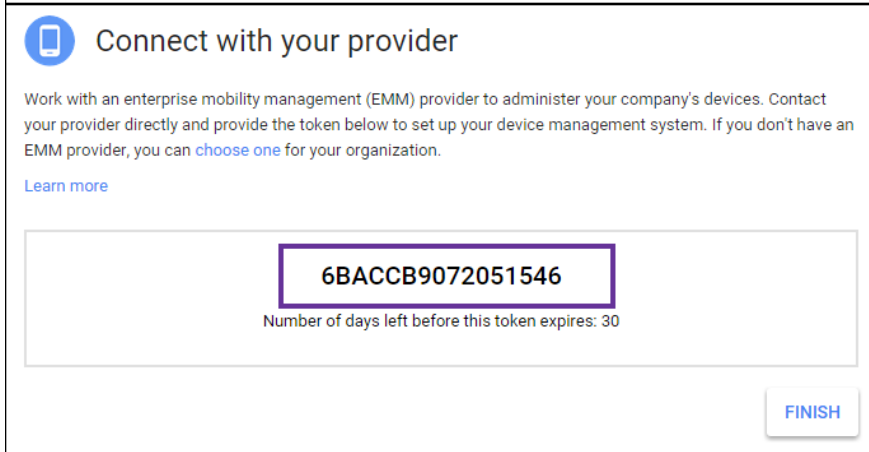

Connect with your provider

Work with an enterprise mobility management (EMM) provider to administer your company's devices. Contact your provider directly and provide the token below to set up your device management system. If you don't have an EMM provider, you can [choose one](#) for your organization.

[Learn more](#)

6BACCB9072051546

Number of days left before this token expires: 30

[FINISH](#)

6. Click **Finish** to complete setting up Android at Work. A page appears, indicating that you've successfully verified your domain.

After you create an Android at Work service account, you can sign in to the Google Admin console to manage your mobility management settings.

Set up an Android at Work service account and download an Android at Work certificate

To allow XenMobile to contact Google Play and Directory services, you must create a service account using the Google Project portal for developers. This service account is used for server-to-server communication between XenMobile and Google services for Android. For more information about the authentication protocol being used, go to <https://developers.google.com/identity/protocols/OAuth2ServiceAccount>.

1. In a web browser, go to <https://console.cloud.google.com/project> and sign in with your Google administrator credentials
2. In the **Projects** list, click **Create Project**.

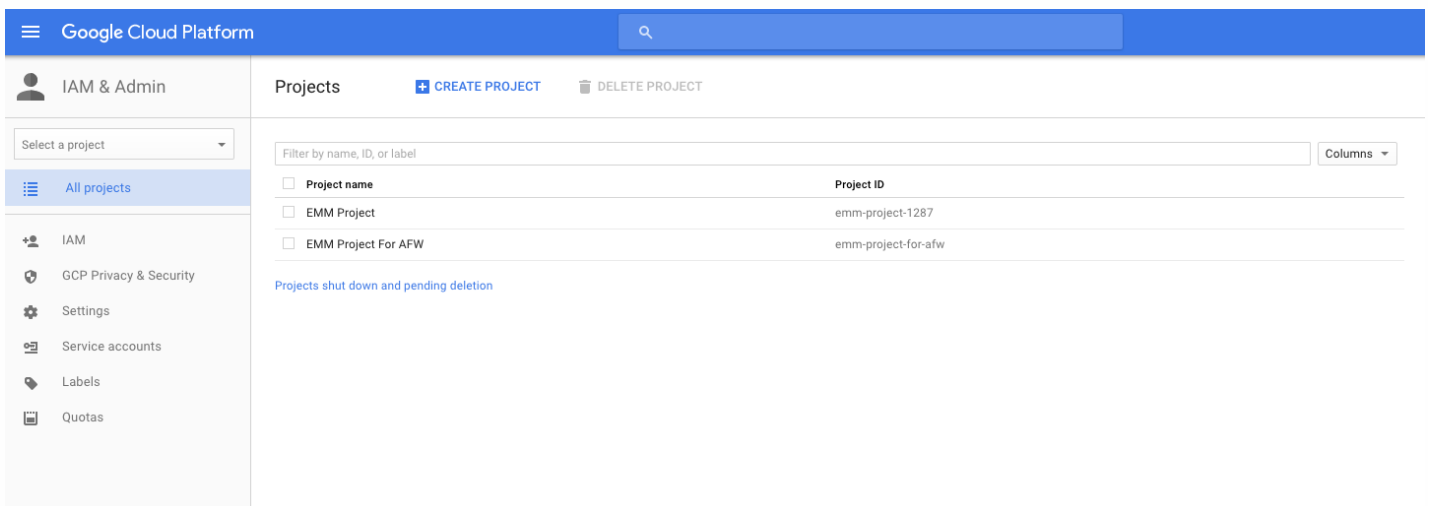

Google Cloud Platform

IAM & Admin

Projects [+ CREATE PROJECT](#) [DELETE PROJECT](#)

Select a project

Filter by name, ID, or label Columns ▾

<input type="checkbox"/> Project name	Project ID
<input type="checkbox"/> EMM Project	emm-project-1287
<input type="checkbox"/> EMM Project For AFW	emm-project-for-afw

[Projects shut down and pending deletion](#)

3. In **Project name**, type a name for the project.

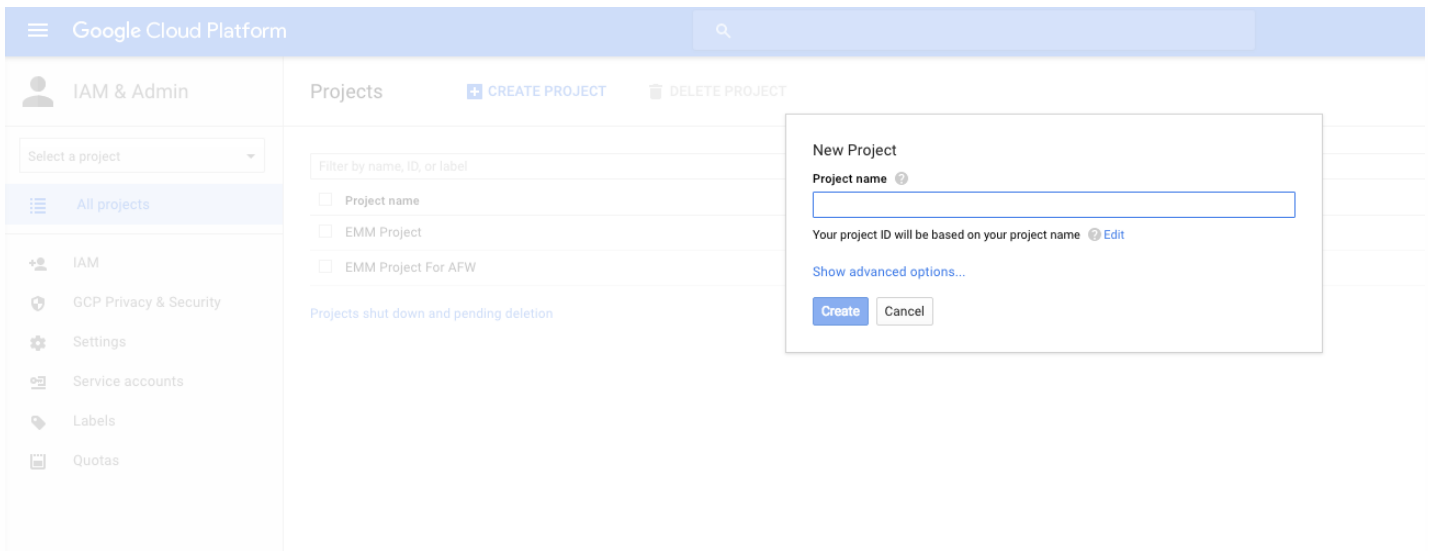

4. On the Dashboard, click **Use Google APIs**.

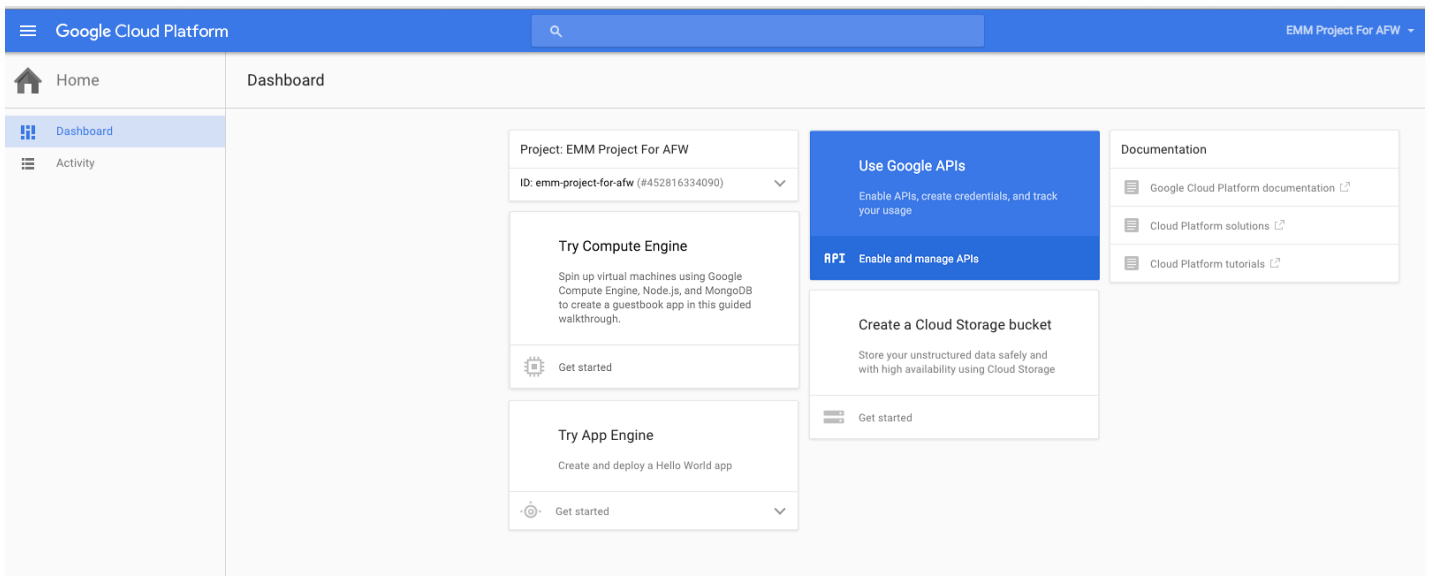

5. Click **Library**, in **Search**, type **EMM** and then click the search result.

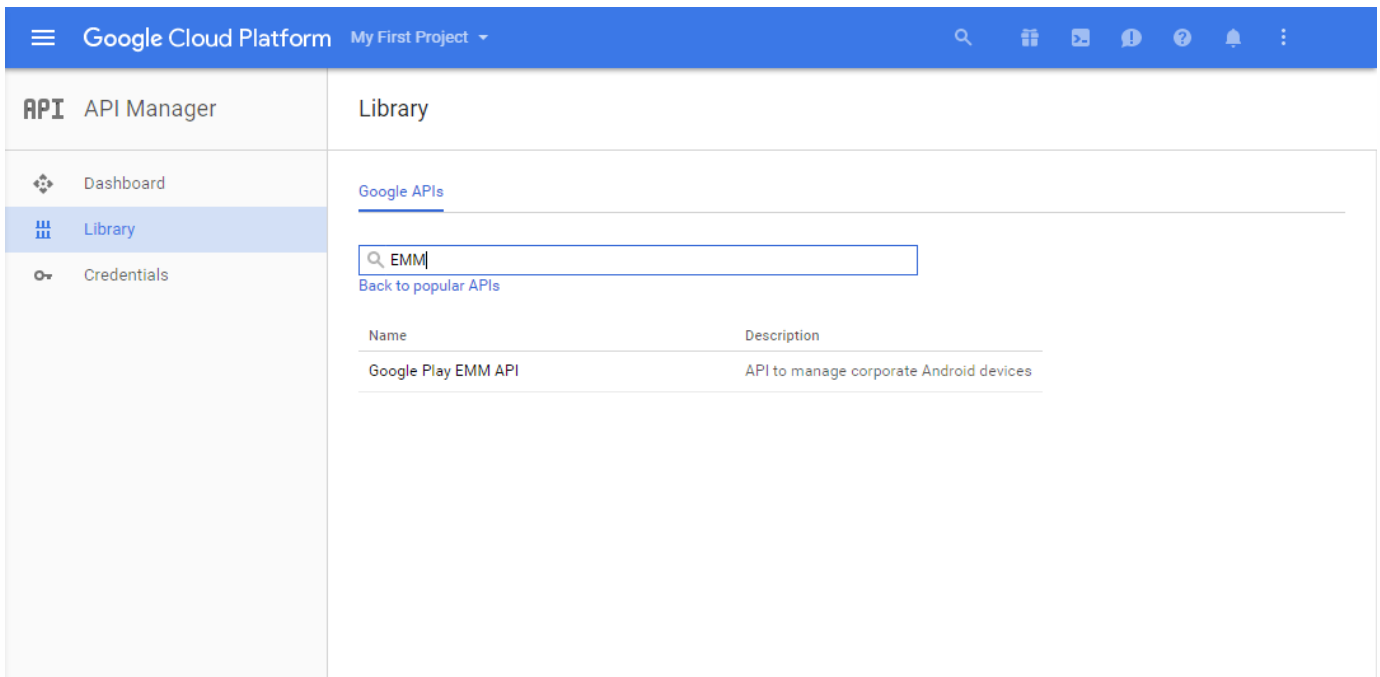

6. On the **Overview** page, click **Enable**.

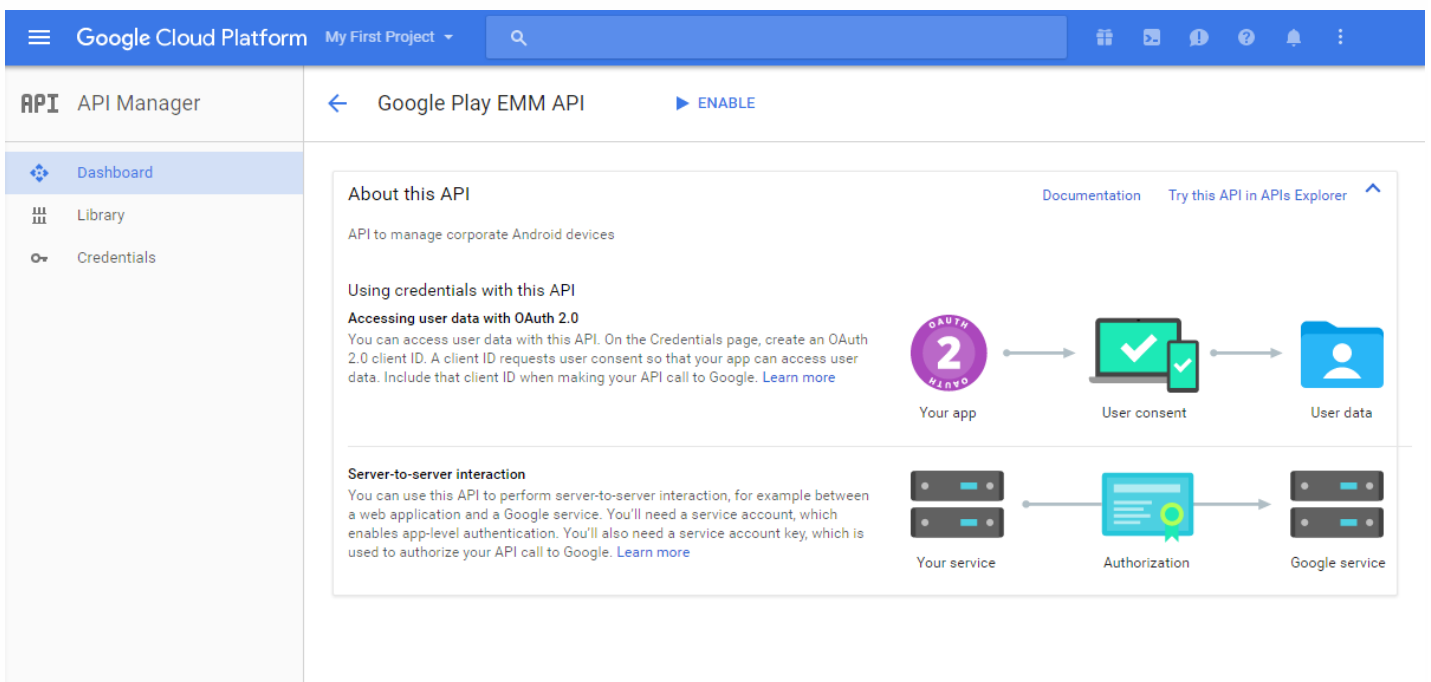

7. Next to **Google Play EMM API**, click **Go to Credentials**.

Google Cloud Platform EMM Project For APW

API Manager Overview

Overview

← Disable

Google Play EMM API

⚠ This API is enabled, but you can't use it in your project until you create credentials. Click "Go to Credentials" to do this now (strongly recommended). [Go to Credentials](#)

Overview Usage Quotas

API to manage corporate Android devices
[Learn more](#)
[Try this API in APIs Explorer](#)

Using credentials with this API

Accessing user data with OAuth 2.0
 You can access user data with this API. On the Credentials page, create an OAuth 2.0 client ID. A client ID requests user consent so that your app can access user data. Include that client ID when making your API call to Google. [Learn more](#)

```

  graph LR
    A[Your app] --> B[User consent]
    B --> C[User data]
  
```

Server-to-server interaction
 You can use this API to perform server-to-server interaction, for example between a web application and a Google service. You'll need a service account, which enables app-level authentication. You'll also need a service account key, which is used to authorize your API call to Google. [Learn more](#)

```

  graph LR
    A[Your service] --> B[Authorization]
    B --> C[Google service]
  
```

8. In the **Add credentials to our project** list, in step 1, click **service account**.

Google Cloud Platform

API Manager Credentials

Overview

Credentials

Add credentials to your project

1 Find out what kind of credentials you need

We'll help you set up the correct credentials
 If you wish you can skip this step and create an [API key](#), [client ID](#), or [service account](#)

Which API are you using?
 Determines what kind of credentials you need.

Google Play EMM API

Where will you be calling the API from?
 Determines which settings you'll need to configure.

Choose...

What data will you be accessing?

User data
 Access data belonging to a Google user, with their permission

Application data
 Access data belonging to your own application

[What credentials do I need?](#)

2 Get your credentials

Cancel

9. On the **Service Accounts** page, click **Create Service Account**.

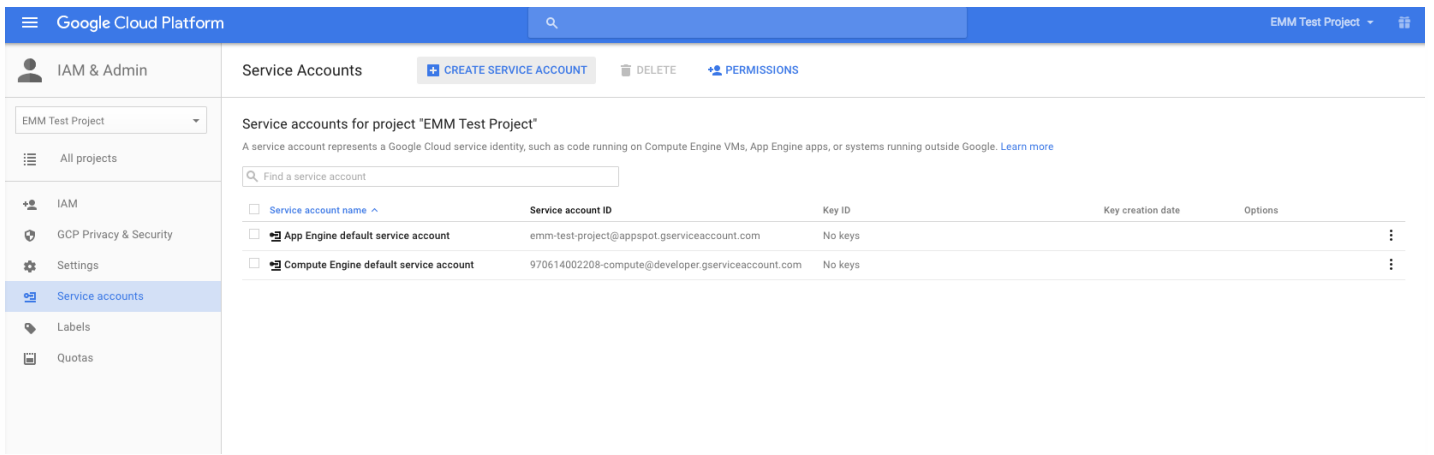

10. In **Create service account**, name the account, and select the **Furnish a new private key** check box. Click **P12**, select the **Enable Google Apps Domain-wide Delegation** check box, and then click **Create**.

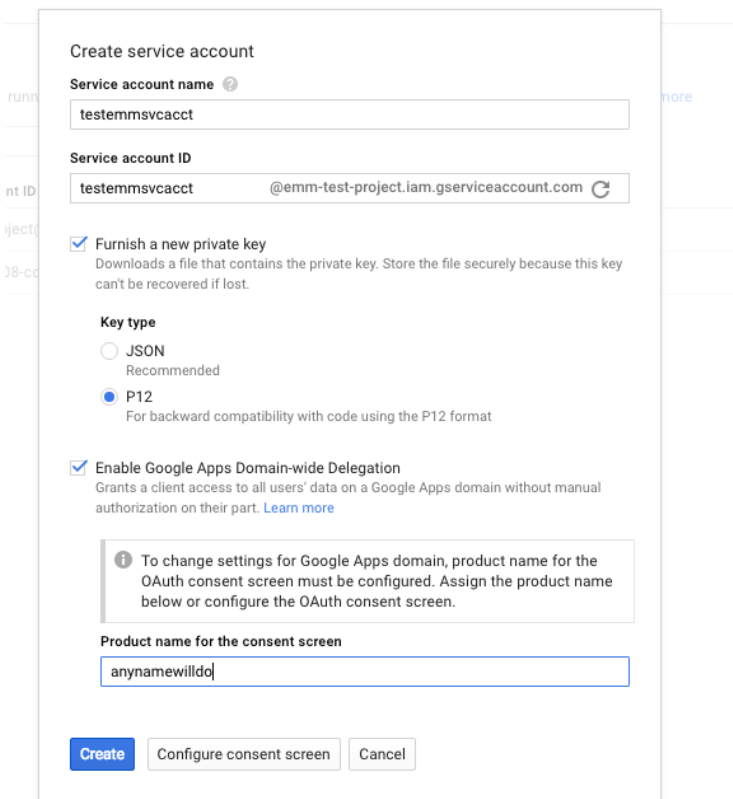

The certificate (P12 file) is downloaded to your computer. Be sure to save the certificate in a secure location.

11. On the **Service account created** confirmation page, click **Close**.

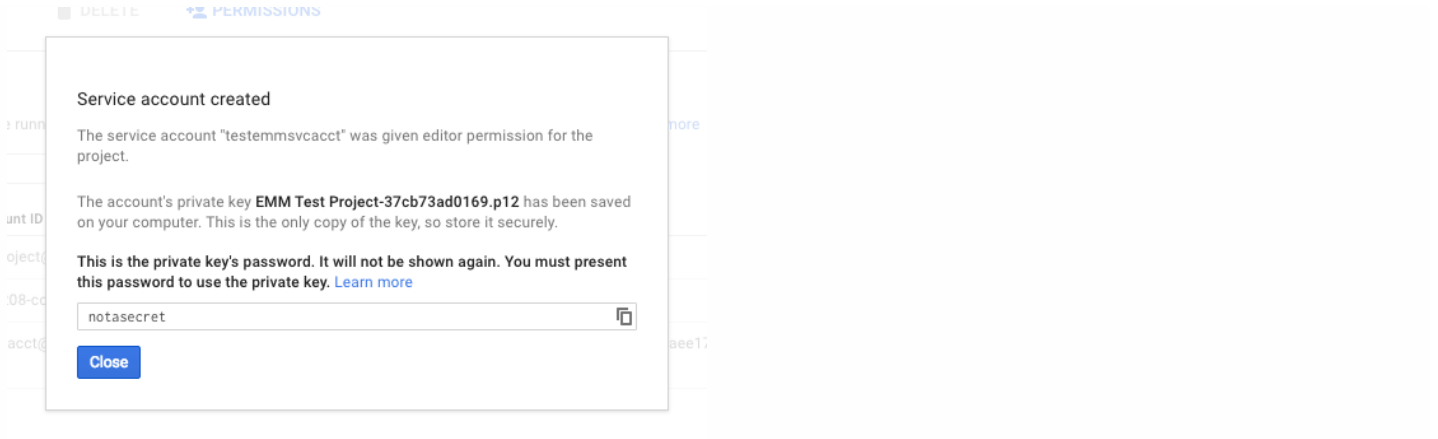

12. In **Permissions**, click **Service accounts** and then under **Options** for your service account, click **View Client ID**.

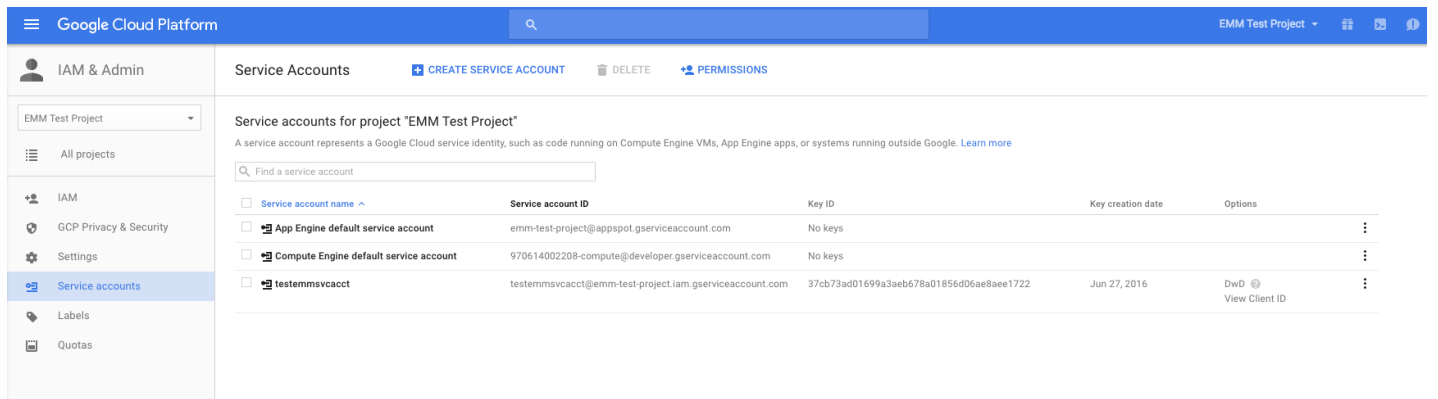

13. The details required for account authorization on the Google admin console display. Copy the **Client ID** and **Service account ID** to a location where you can retrieve the information later. You need this information, along with the domain name to send to Citrix support for whitelisting.

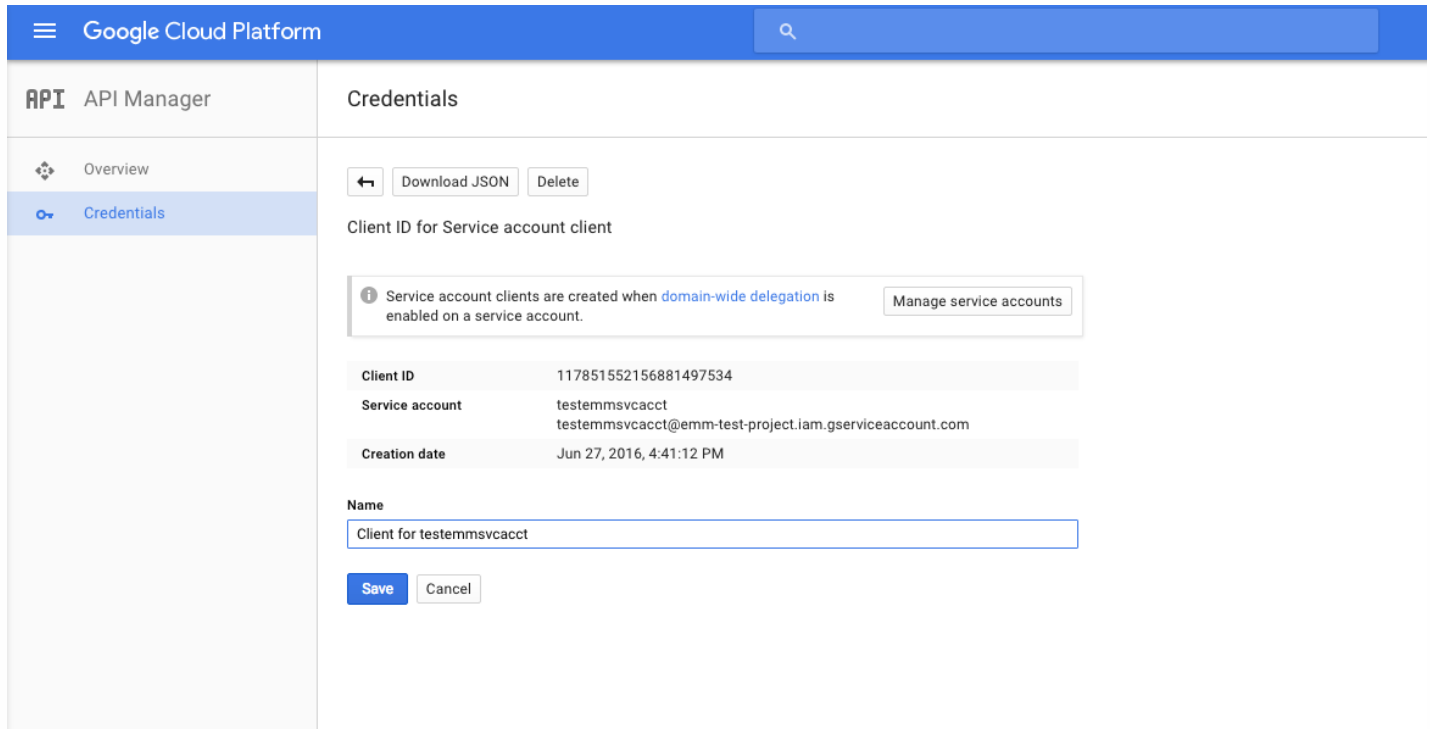

14. On the **Library** page, search for **Admin SDK** and then click the search result.

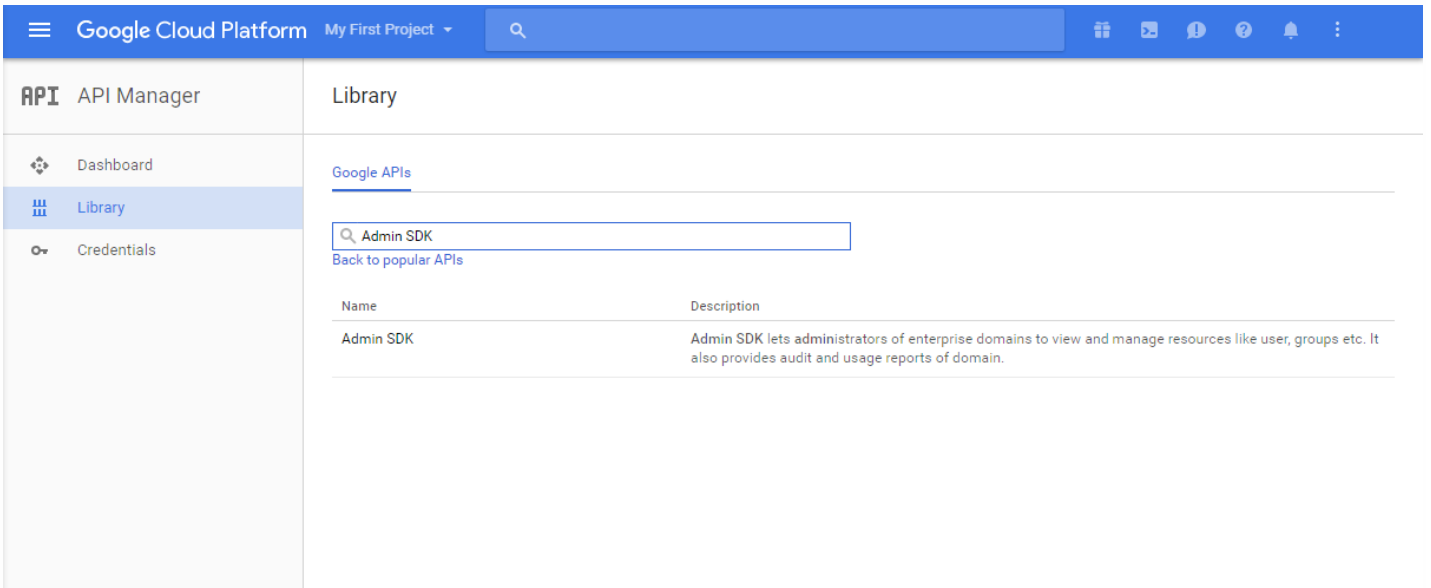

15. On the **Overview** page, click **Enable**.

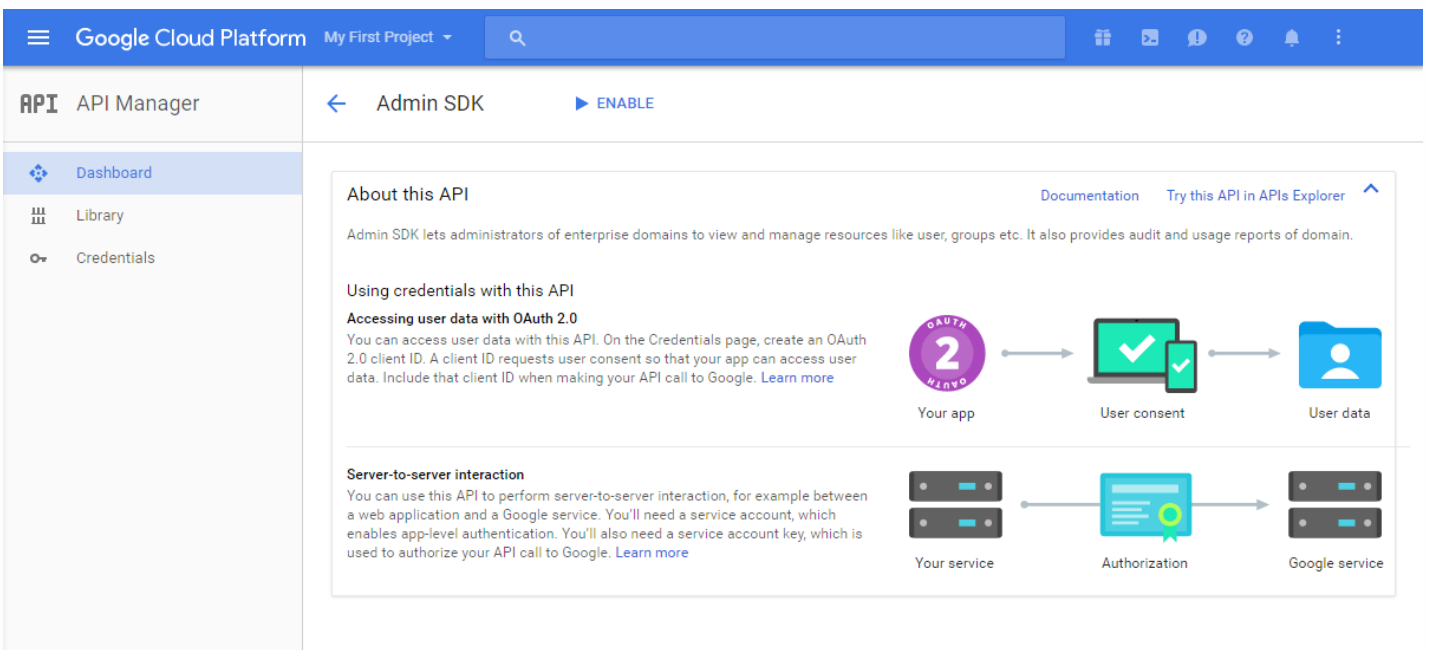

16. Open the Google admin console for your domain and then click **Security**.

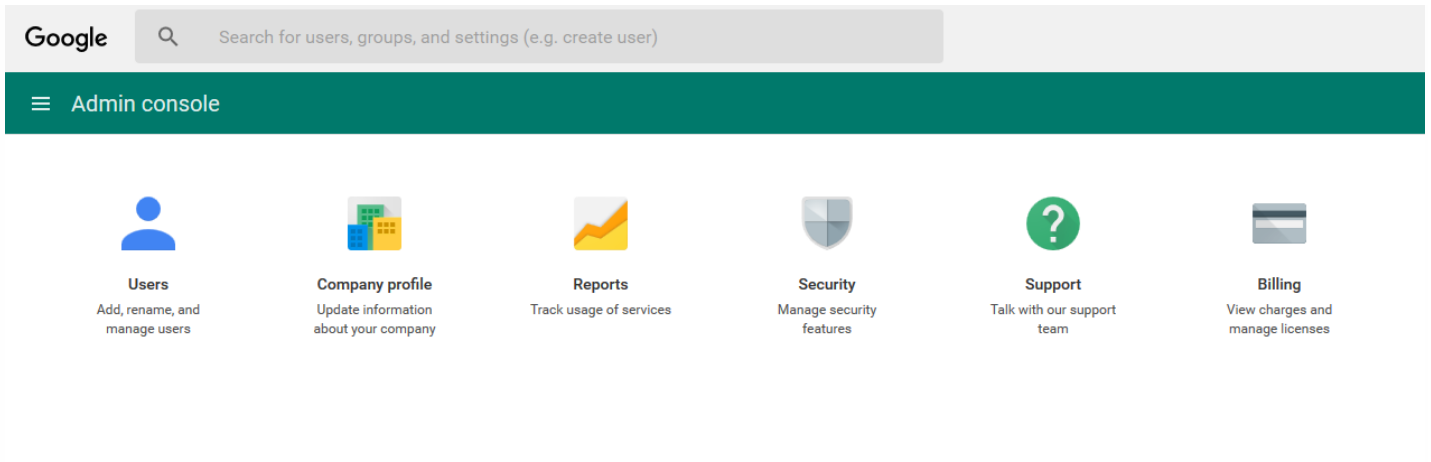

17. On the **Settings** page, click **Show more** and then click **Advanced settings**.

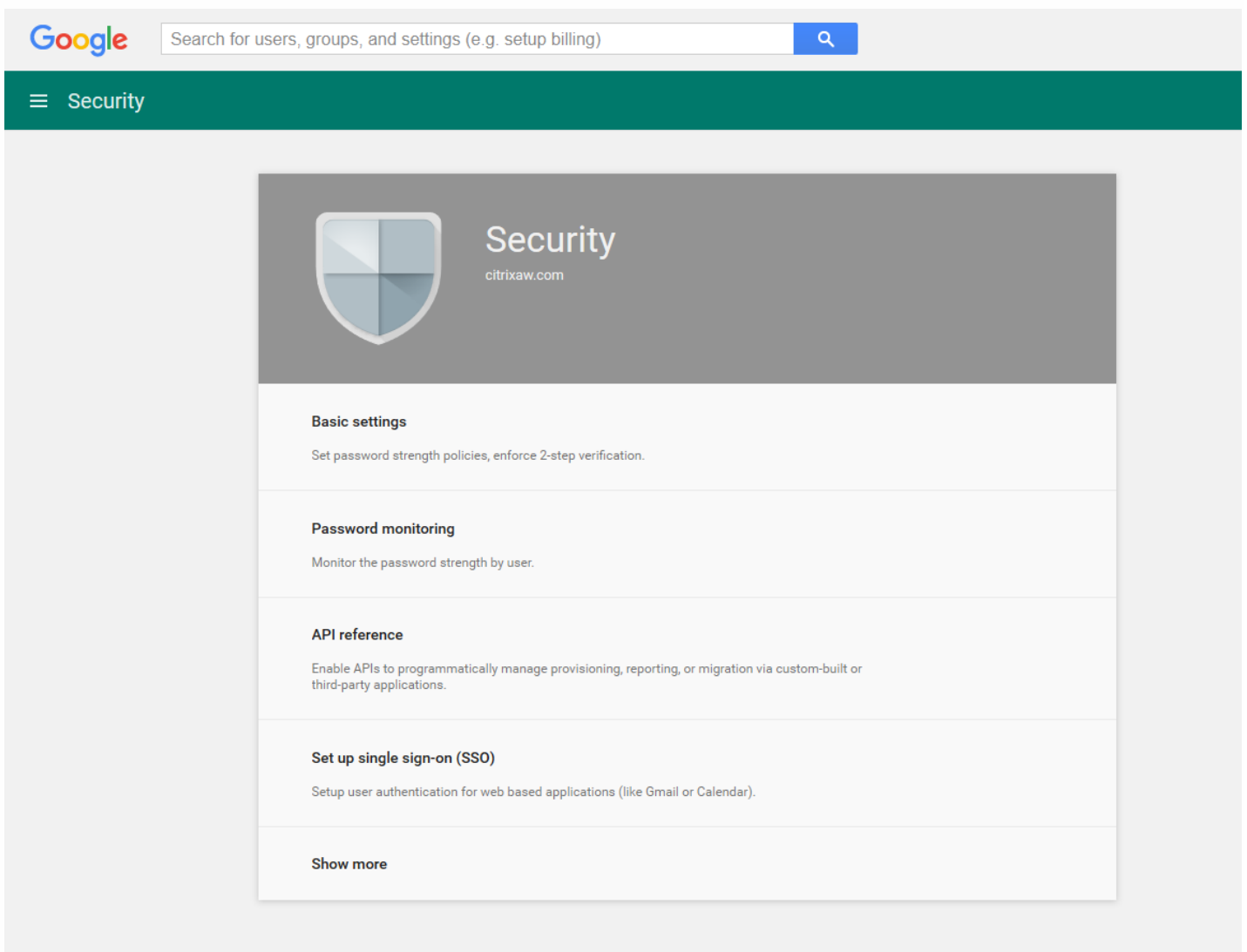



Security

citrixaw.com

Basic settings

Set password strength policies, enforce 2-step verification.

Password monitoring

Monitor the password strength by user.

API reference

Enable APIs to programmatically manage provisioning, reporting, or migration via custom-built or third-party applications.

Set up single sign-on (SSO)

Setup user authentication for web based applications (like Gmail or Calendar).

Manage EMM provider for Android

Keep your company's devices secure with an enterprise mobility management provider.

Advanced settings

Manage advanced security features such as authentication, and integrating G Suite with internal services.

18. Click **Manage API client access**.

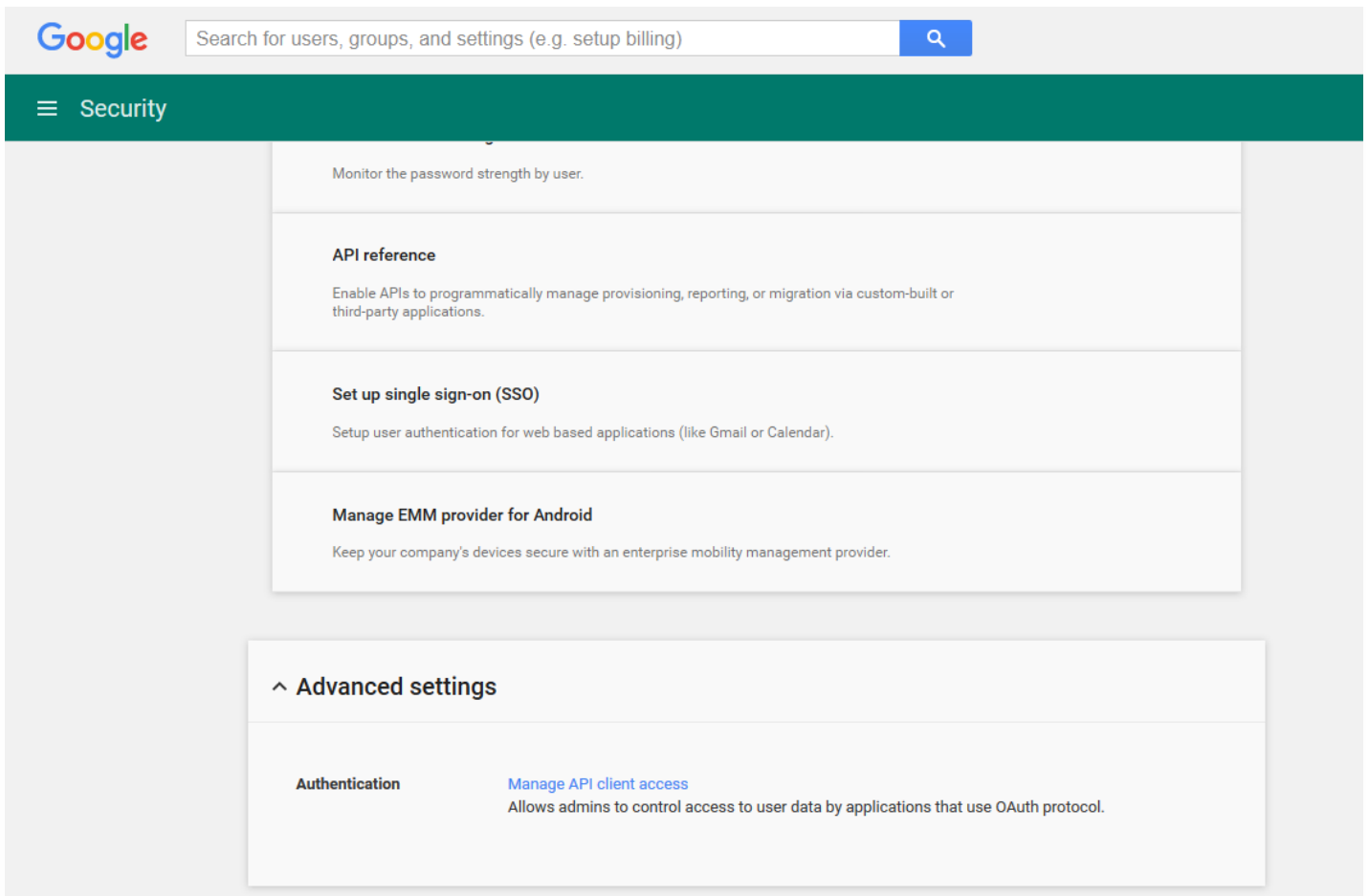

19. In **Client Name**, type the client ID that you saved earlier, in **One or More API Scopes**, type <https://www.googleapis.com/auth/admin.directory.user> and then click **Authorize**.

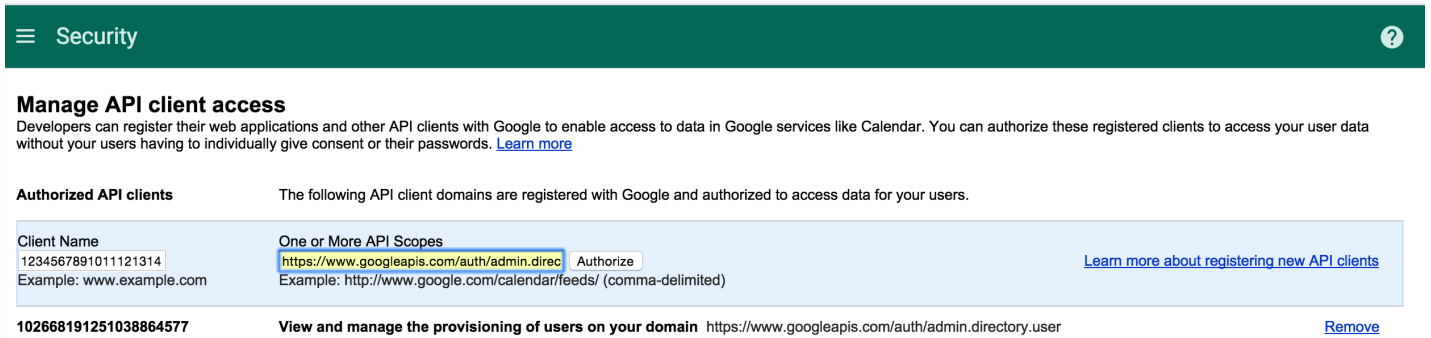

Binding to EMM

Before you can use XenMobile to manage your Android devices, you must contact Citrix Technical Support and provide your domain name, service account, and binding token. Citrix binds the token to XenMobile as your enterprise mobility management (EMM) provider. For contact information for Citrix Technical Support, see [Citrix Technical Support](#).

1. To confirm the binding, sign in to the Google Admin portal and then click **Security**.
2. Click **Manage EMM provider for Android**.

You see that your Google Android for Work account is bound to Citrix as your EMM provider.

After you confirm the token binding, you can start using the XenMobile console to manage your Android devices. Import the P12 certificate you generated in step 14. Set up Android at Work server settings, enable SAML-based single-sign-on (SSO), and define at least one Android for Work device policy.

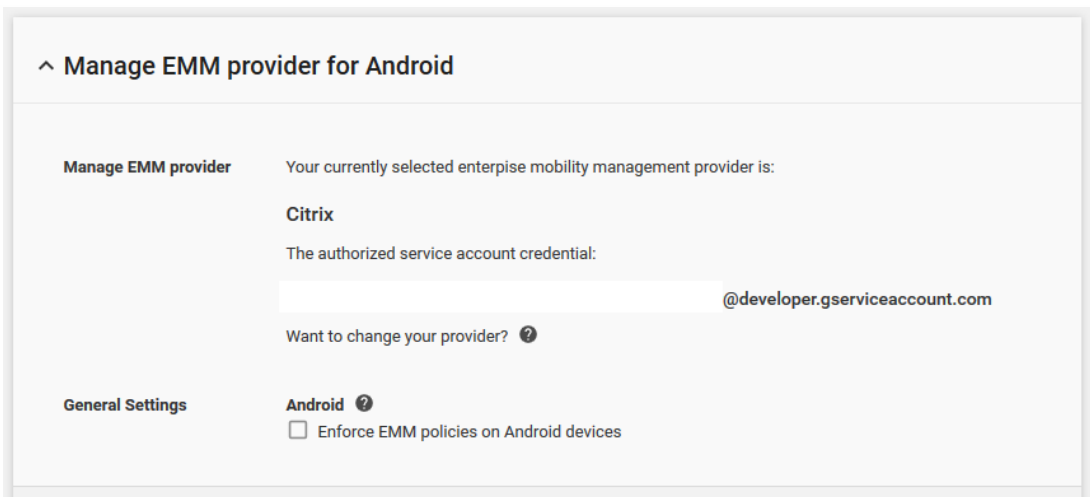

Import the P12 certificate

Follow these steps to import your Android at Work P12 certificate:

1. Sign in to the XenMobile console.
2. Click the gear icon in the upper-right corner of the console to open the **Settings** page and then click **Certificates**. The **Certificates** page displays.

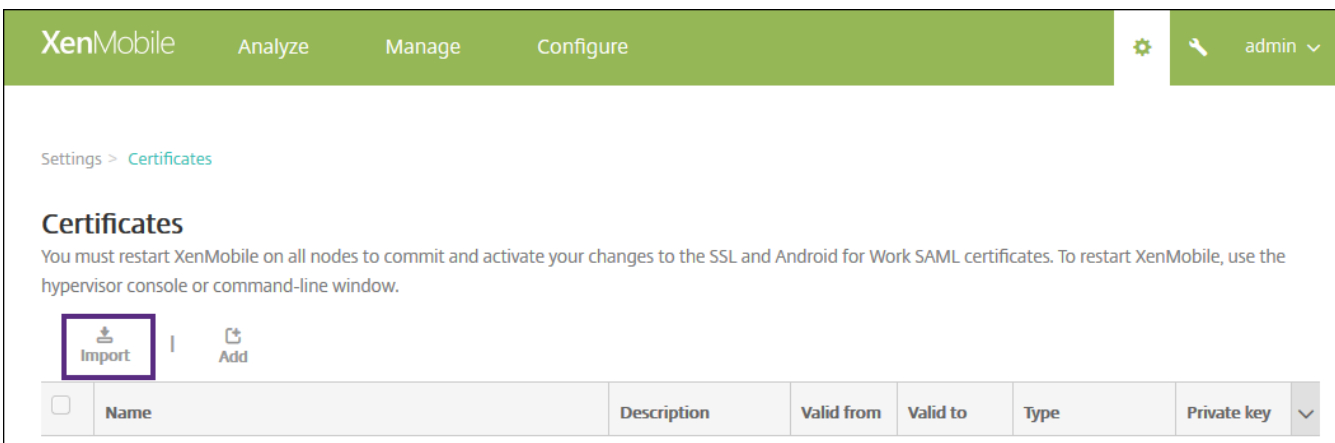

3. Click **Import**. The **Import** dialog box displays.

Import ✕

You can import certificates or keystores used by PKI components. You can import several certificates, but you can only have one certificate active at a time.

Import:

Keystore type:

Use as:

Keystore file:

Password:

Description:

Configure the following settings:

- **Import:** In the list, click **Keystore**.
- **Keystore type:** In the list, click **PKCS#12**.
- **Use as:** In the list, click **Server**.
- **Keystore file:** Click **Browse** and navigate to the P12 certificate.
- **Password:** Type the keystore password.
- **Description:** Optionally, type a description of the certificate.

4. Click **Import**.

Set up Android at Work server settings

1. In the XenMobile console, click the gear icon in the upper-right corner of the console. The **Settings** page displays.
2. Under **Server**, click **Android for Work**. The **Android for Work** page displays.

XenMobile Analyze Manage Configure ⚙️ 🔍 admin ▾

Settings > Android for Work

Android for Work

Provide Android for Work configuration parameters.

Domain Name*

Domain Admin Account*

Service Account ID*

Enable Android for Work

Configure the following settings:



- **Domain name:** Type your Android at Work domain name; for example, domain.com.
- **Domain Admin Account:** Type your domain administrator user name; for example, the email account used for Google Developer Portal.
- **Service Account ID:** Type your service account ID; for example, the email associated in the Google Service Account (serviceaccountemail@xxxxxxxxx.iam.gserviceaccount.com).
- **Enable Android for Work:** Click to enable or disable Android at Work.

3. Click **Save**.

Enable SAML-based single-sign-on

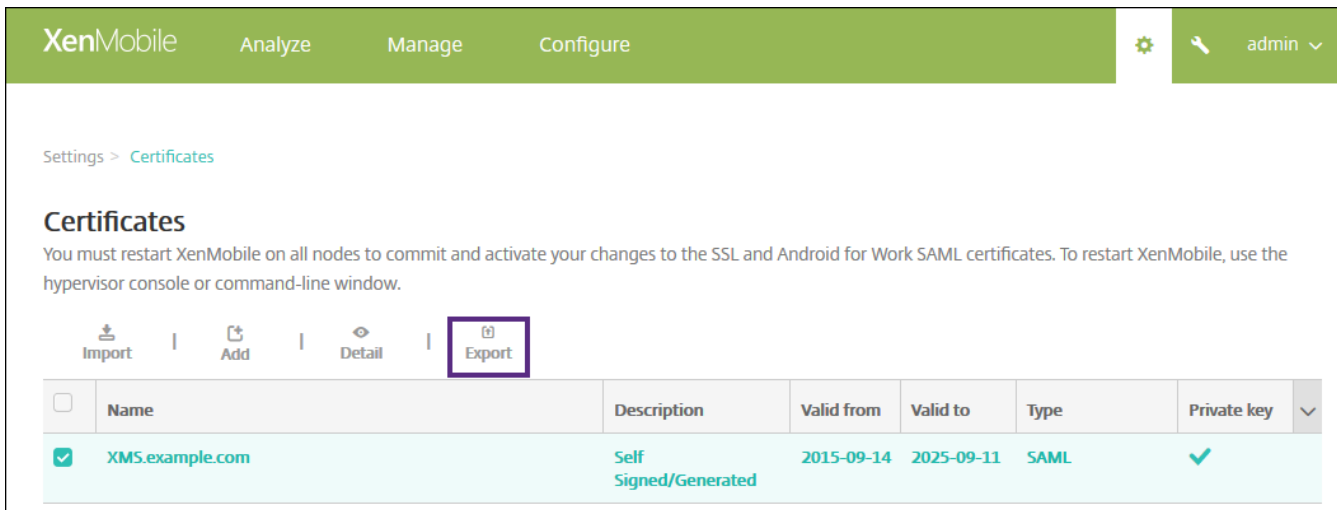
1. Sign in to the XenMobile console.
2. Click the gear icon in the upper-right corner of the console. The **Settings** page displays.
3. Click **Certificates**. The **Certificates** page displays.







XenMobile Analyze Manage Configure  admin 

Settings > Certificates

Certificates

You must restart XenMobile on all nodes to commit and activate your changes to the SSL and Android for Work SAML certificates. To restart XenMobile, use the hypervisor console or command-line window.

 Import |  Add |  Detail |  Export





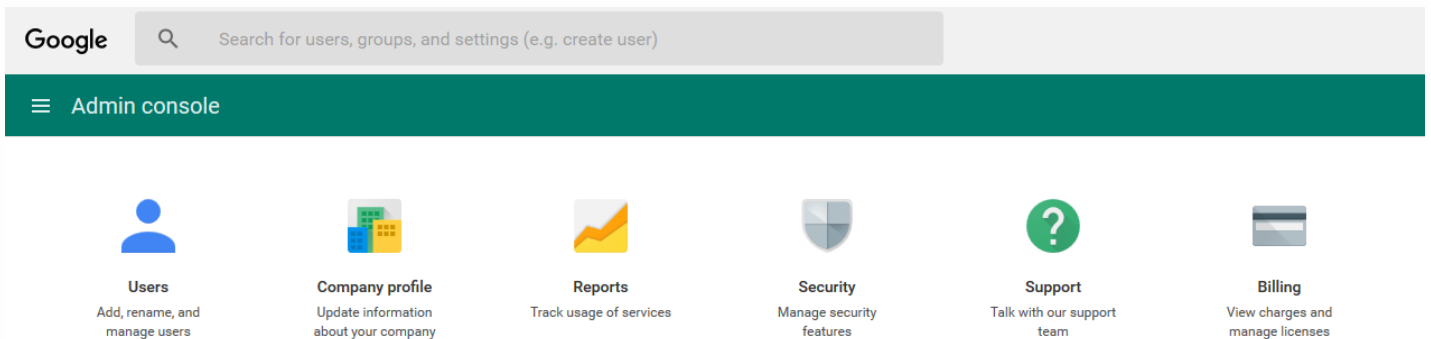

<input type="checkbox"/>	Name	Description	Valid from	Valid to	Type	Private key
<input checked="" type="checkbox"/>	XMS.example.com	Self Signed/Generated	2015-09-14	2025-09-11	SAML	

3. In the list of certificates, click the SAML certificate.
4. Click **Export** and save the certificate to your computer.
5. Sign in to the Google Admin portal by using your Android at Work administrator credentials. For access to the portal, see [Google Admin portal](#).
6. Click **Security**.



Google  Search for users, groups, and settings (e.g. create user)

Admin console

-  **Users**
Add, rename, and manage users
-  **Company profile**
Update information about your company
-  **Reports**
Track usage of services
-  **Security**
Manage security features
-  **Support**
Talk with our support team
-  **Billing**
View charges and manage licenses

7. Under **Security**, click **Set up single sign-on (SSO)** and then configure the following settings.

^ Set up single sign-on (SSO)

SAML-based Single Sign-On allows you to authenticate accounts for web based applications (like Gmail or Calendar). With SSO, users sign in for one web application, and are automatically signed in for all other Google web apps. For desktop applications (or POP access to Gmail), users must sign in directly with the username and password set up via the Admin console. ?

Setup SSO with third party identity provider

To setup third party as your identity provider, please provide the information below. ?

Sign-in page URL

URL for signing in to your system and Google Apps

Sign-out page URL

URL for redirecting users to when they sign out

Change password URL

URL to let users change their password in your system; when defined here, this is shown even when Single Sign-on is not enabled

Verification certificate

The certificate file must contain the public key for Google to verify sign-in requests. ?

Use a domain specific issuer ?

Network masks

Network masks determine which addresses will be affected by single sign-on. If no masks are specified, SSO functionality will be applied to the entire network. Use a semicolon to separate the masks. Example: (64.233.187.99/8; 72.14.0.0/16). For ranges, use a dash. Example: (64.233.167-204.99/32). All network masks must end with a CIDR. ?

[DISCARD CHANGES](#) [SAVE CHANGES](#)

- **Sign-in page URL:** Type the URL for users signing in to your system and Google Apps. For example: `https://<Xenmobile-FQDN>/aw/saml/signin`.
- **Sign out page URL:** Type the URL to which users are redirected when they sign out. For example: `https://<Xenmobile-FQDN>/aw/saml/signout`.
- **Change password URL:** Type the URL to let users change their password in your system. For example: `https://<Xenmobile-FQDN>/aw/saml/changepassword`. If this field is defined, users see this prompt even when SSO is not available.
- **Verification certificate:** Click **CHOOSE FILE** and then navigate to the SAML certificate exported from XenMobile.

8. Click **SAVE CHANGES**.

Set up an Android at Work device policy

It is wise to set up a passcode policy so that users must establish a passcode on their devices when they first enroll.

The screenshot shows the XenMobile web console interface for configuring a Passcode Policy. The top navigation bar includes 'XenMobile', 'Analyze', 'Manage', and 'Configure'. The 'Configure' section has sub-tabs for 'Device Policies', 'Apps', 'Actions', 'ShareFile', 'Enrollment Profiles', and 'Delivery Groups'. The 'Device Policies' tab is active, showing a list of policies on the left, with 'Passcode Policy' selected. The main area displays the 'Passcode Policy' configuration page, which includes a description, a 'Passcode Required' toggle (ON), and various settings for passcode requirements, biometric recognition, and security. The 'Passcode security' section includes settings for lock device after inactivity, passcode expiration, previous passwords saved, and maximum failed sign-on attempts. A 'Deployment Rules' section is also visible at the bottom.

The basic steps to setting up any device policy are as follows.

1. Sign on to the XenMobile console.
2. Click **Configure**, and then click **Device Policies**.
3. Click **Add** and then on the **Add a New Policy** dialog box, select the policy you want to add. In this example, you click **Passcode**.
4. Complete the **Policy Information** page.
5. Click **Android for Work** and then configure the settings for the policy.
6. Assign the policy to a Delivery Group.

For more information about setting up other device policies that are available for Android for Work, see [XenMobile Device Policies by Platform](#).

Configure Android at Work account settings

Before you can start managing Android apps and policies on devices, you must set up an Android at Work domain and account information in XenMobile. First, complete Android at Work setup tasks on Google to set up a domain administrator and to obtain a service account ID and a binding token.

1. In the XenMobile web console, click the gear icon in the upper-right corner. The **Settings** page displays.
2. Under **Server**, click **Android for Work**. The **Android for Work** configuration page displays.

Settings > [Android for Work](#)

Android for Work

Provide Android for Work configuration parameters.

Domain Name*	<input type="text"/>
Domain Admin Account*	<input type="text"/>
Service Account ID*	<input type="text"/>
Enable Android for Work	<input checked="" type="radio"/>

3. On the **Android for Work** page, configure the following settings:

- **Domain Name:** Type your domain name.
- **Domain Admin Account:** Type your domain administrator user name.
- **Service Account ID:** Type your Google Service Account ID.
- **Enable Android for Work:** Select whether to enable Android for Work or not.

4. Click **Save**.

Provisioning Device Owner mode in Android at Work

If you want to provision Android at Work in Device Owner mode, you must transfer data through a near-field communications (NFC) bump between two devices. One must be running the XenMobile Provisioning Tool and one must be restored to its factory settings. Device Owner mode is available for corporate-owned devices only.

Why NFC? Bluetooth, Wi-Fi, and other communication modes are disabled on a factory-reset device. NFC is the only communication protocol that the device can use in this state.

Prerequisites

- A XenMobile Server version 10.4 that is enabled for Android at Work.
- A factory-reset device, provisioned for Android at Work in Device Owner mode. You can find steps to complete this prerequisite later in this article.
- Another device with NFC capability, running the configured Provisioning Tool. The Provisioning Tool is available in Secure Hub 10.4 or on the [Citrix downloads page](#).

Each device can have only one Android at Work profile, managed by an enterprise mobility management (EMM) app. In XenMobile, Secure Hub is the EMM app. Only one profile is allowed on each device. Attempting to add a second EMM app removes the first EMM app.

You can start Device Owner mode on new devices or on devices restored to factory settings. You manage the entire device by using XenMobile.

NFC bump in Device Owner mode

Provisioning a factory-reset device requires you to send the following data via an NFC bump to initialize Android at Work:

- Package name of the EMM provider app that acts as Device Owner (in this case, Secure Hub).
- Intranet/Internet location from which the device can download the EMM provider app.
- SHA1 hash of EMM provider app to verify if the download is successful.
- Wi-Fi connection details so that a factory-reset device can connect and download the EMM provider app. Note: Android now does not support 802.1x Wi-Fi for this step.

- Time zone for the device (optional).
- Geographic location for the device (optional).

When the two devices are bumped, the data from the Provisioning Tool is sent to the factory-reset device. That data is then used to download Secure Hub with administrator settings. If you don't enter time zone and location values, Android automatically configures the values on the new device.

Configuring the XenMobile Provisioning Tool

Before doing an NFC bump, you must configure the Provisioning Tool. This configuration is then transferred to the factory-reset device during the NFC bump.

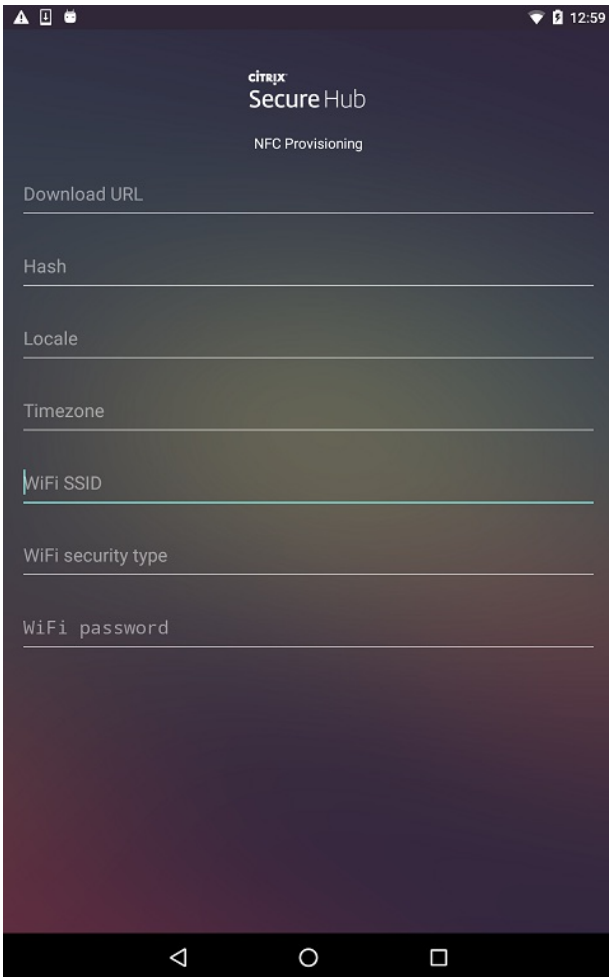

The screenshot shows the Citrix Secure Hub NFC Provisioning configuration screen on an Android device. The screen has a dark background with white text. At the top, the Citrix logo and 'Secure Hub' are displayed, followed by 'NFC Provisioning'. Below this, there are several input fields for configuration: 'Download URL', 'Hash', 'Locale', 'Timezone', 'WiFi SSID', 'WiFi security type', and 'WiFi password'. The 'WiFi SSID' field is currently active, indicated by a green cursor. The bottom of the screen shows the standard Android navigation bar with back, home, and recent apps buttons.

You can type data into the required fields or populate them via text file. The steps in the next procedure describe how to configure the text file and contain descriptions for each field. The app doesn't save information after you type it, so you might want to create a text file to keep the information for future use.

To configure the Provisioning Tool by using a text file

Name the file `nfcprovisioning.txt` and place the file in the `/sdcard/` folder on the SD card of the device. The app can then read the text file and populate the values.

The text file must contain the following data:

android.app.extra.PROVISIONING_DEVICE_ADMIN_PACKAGE_DOWNLOAD_LOCATION=<download_location>

This line is the intranet/internet location of the EMM provider app. After the factory-reset device connects to Wi-Fi following the NFC bump, the device must have access to this location for downloading. The URL is a regular URL, with no special formatting required.

android.app.extra.PROVISIONING_DEVICE_ADMIN_PACKAGE_CHECKSUM=<SHA1 hash>

This line is the checksum of the EMM provider app. This checksum is used to verify that the download is successful. Steps to obtain the checksum are discussed later in this article.

android.app.extra.PROVISIONING_WIFI_SSID=<wifi ssid>

This line is the connected Wi-Fi SSID of the device on which the Provisioning Tool is running.

android.app.extra.PROVISIONING_WIFI_SECURITY_TYPE=<wifi security type>

Supported values are WEP and WPA2. If the Wi-Fi is unprotected, this field must be empty.

android.app.extra.PROVISIONING_WIFI_PASSWORD=<wifi password>

If the Wi-Fi is unprotected, this field must be empty.

android.app.extra.PROVISIONING_LOCALE=<locale>

Enter language and country codes. The language codes are two-letter lowercase ISO language codes (such as `en`) as defined by [ISO 639-1](#). The country codes are two-letter uppercase ISO country codes (such as `US`) as defined by [ISO 3166-1](#). For example, type `en_US` for English as spoken in the United States. If you don't type any codes, the country and language are automatically populated.

android.app.extra.PROVISIONING_TIME_ZONE=<timezone>

The time zone in which the device is running. Type an [Olson name of the form area/location](#). For example, `America/Los_Angeles` for Pacific time. If you don't enter a name, the time zone is automatically populated.

android.app.extra.PROVISIONING_DEVICE_ADMIN_PACKAGE_NAME=<package name>

This data isn't required, because the value is hardcoded into the app as Secure Hub. It's mentioned here only for the sake of completion.

If there is a Wi-Fi protected by using WPA2, a completed `nfcprovisioning.txt` file might look like the following:

```
android.app.extra.PROVISIONING_DEVICE_ADMIN_PACKAGE_DOWNLOAD_LOCATION=http://www.somepublicurhere.com/path/to/securehub.apk
android.app.extra.PROVISIONING_DEVICE_ADMIN_PACKAGE_CHECKSUM=ga50TwdCmf dj72LGRFkke4CrbAk\u003d
android.app.extra.PROVISIONING_WIFI_SSID=Protected_WiFi_Name
android.app.extra.PROVISIONING_WIFI_SECURITY_TYPE=WPA2
android.app.extra.PROVISIONING_WIFI_PASSWORD=wifiPasswordHere
android.app.extra.PROVISIONING_LOCALE=en_US
android.app.extra.PROVISIONING_TIME_ZONE=America/Los_Angeles
```

If there is an unprotected Wi-Fi, a completed `nfcprovisioning.txt` file might look like the following:

```
android.app.extra.PROVISIONING_DEVICE_ADMIN_PACKAGE_DOWNLOAD_LOCATION=http://www.somepublicurhere.com/path/to/securehub.apk
```

android.app.extra.PROVISIONING_DEVICE_ADMIN_PACKAGE_CHECKSUM=ga50TwdCmf dj72LGRFkke4CrbAK\u003d

android.app.extra.PROVISIONING_WIFI_SSID=Unprotected_WiFi_Name

android.app.extra.PROVISIONING_LOCALE=en_US

android.app.extra.PROVISIONING_TIME_ZONE=America/Los_Angeles

To get the Secure Hub checksum

To get the checksum of any app, add the app as an enterprise app.

1. In the XenMobile console, go to **Configure > Apps** and then click **Add**.

The screenshot shows the XenMobile console interface. The top navigation bar includes 'XenMobile', 'Analyze', 'Manage', and 'Configure'. The 'Configure' section is active, showing sub-tabs for 'Device Policies', 'Apps', 'Actions', 'ShareFile', 'Enrollment Profiles', and 'Delivery Groups'. The 'Apps' tab is selected, displaying a list of apps. The 'Add' button is visible at the top left of the app list. The app list has the following columns: Icon, App Name, Type, Category, Created On, Last Updated, and Disable. The apps listed are:

Icon	App Name	Type	Category	Created On	Last Updated	Disable
	hh viber	Public App Store	Default	10/18/16 7:55 AM	10/18/16 7:55 AM	
	hh ebay	Public App Store	Default	10/18/16 8:04 AM	10/18/16 8:04 AM	
	hh green	Enterprise	Default	10/18/16 8:07 AM	10/18/16 8:07 AM	
	hh pink	Enterprise	Default	10/18/16 8:08 AM	10/18/16 8:08 AM	
	hh web & saas	Web & SaaS	Default	10/18/16 8:09 AM	10/18/16 8:09 AM	
	hh weblink	Web Link	Default	10/18/16 8:10 AM	10/18/16 8:10 AM	
	MRF Android Enterprise TD	Enterprise	Default	10/18/16 8:12 AM	10/18/16 8:12 AM	
	hh UWH	Enterprise	Default	10/18/16 8:17 AM	10/18/16 8:17 AM	
	hh WW	MDX	Default	10/18/16 8:18 AM	10/18/16 8:18 AM	

The **Add Apps** window appears.

2. Click **Enterprise**.

The **App information** page displays.

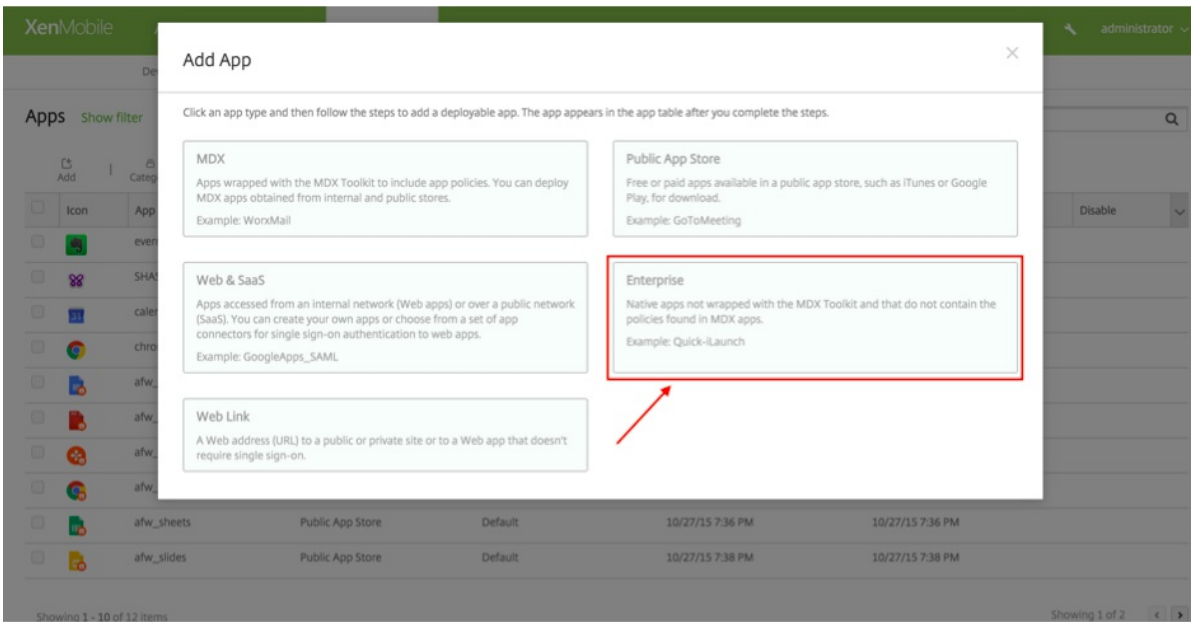

3. Select the following configuration and then click **Next**.

The **Android for Work Enterprise App** page displays.

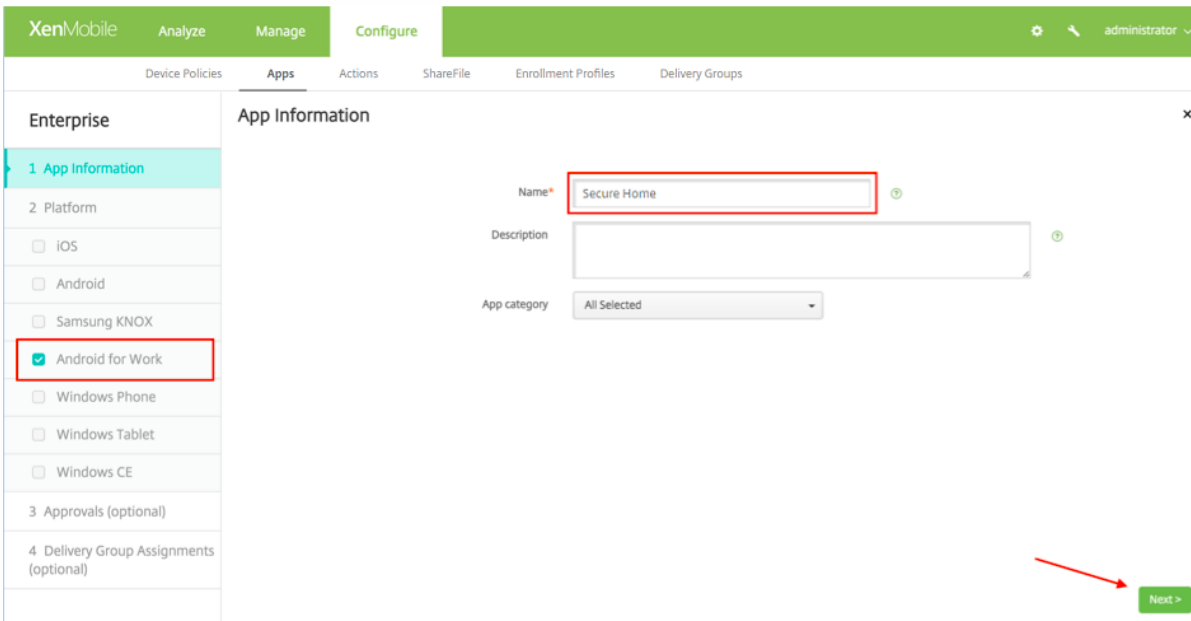

4. Provide the path to the .apk and then click **Next** to upload the file.

Once the upload is complete, the details of the uploaded package display.

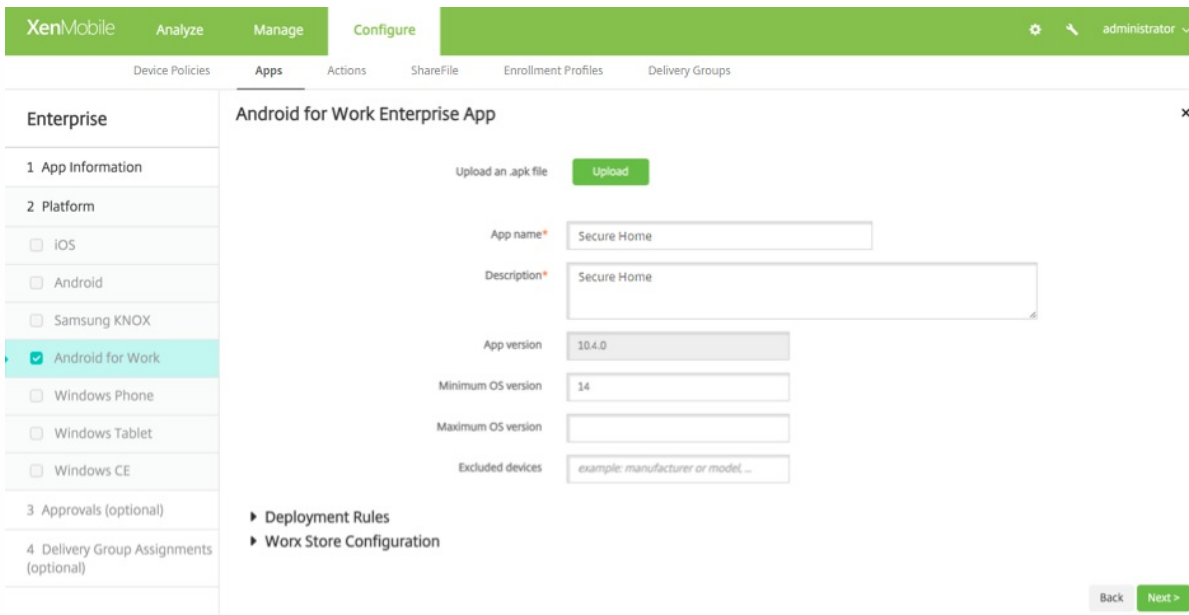

5. Click **Next** to bring up a page to download the JSON file, which you then use to upload to Google Play. For Secure Hub, uploading to Google Play is not required, but you need the JSON file to read the SHA1 value from it.

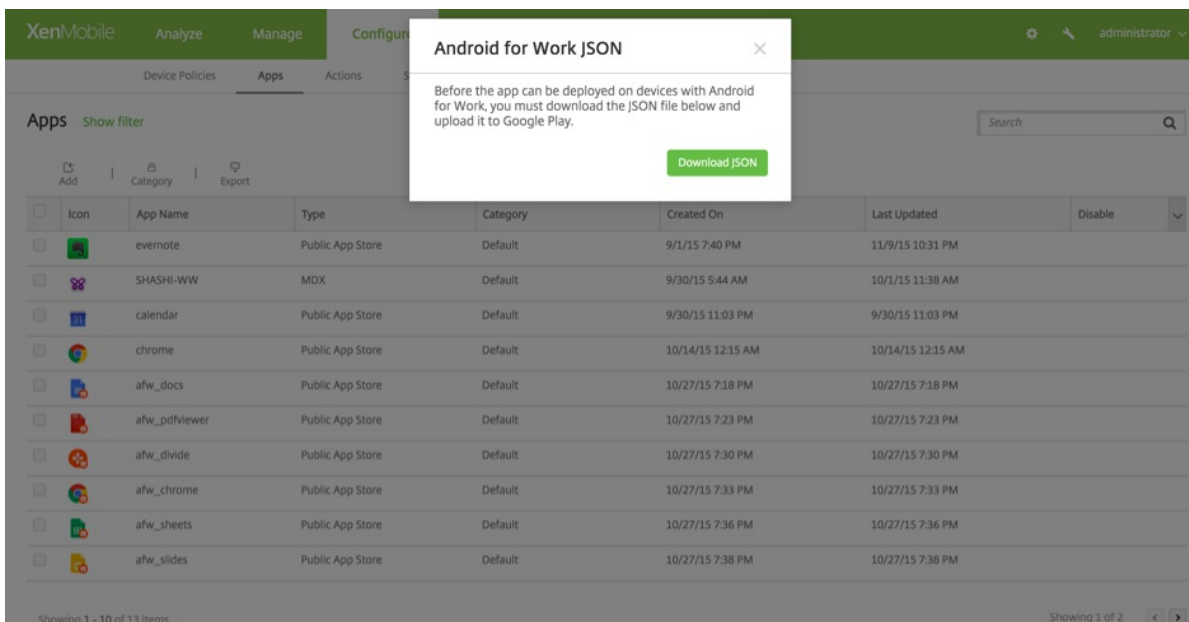

A typical JSON file looks like the following:

```

1  {"icon_filename":"48_48_launcher.png","file_sha256_base64":
2  "0IMZ86TLG9TxBs1NFE0ncN1Q0wAVkKvLA0QJP3AvsU083d","file_sha1_base64":
3  "t54vUwLtkz7fx8mT3Cnmpk3o0u083d","package_name":"com.zenprise",
4  "application_label":"Worx Home","icon_base64":
5  "iVBORw0KGgoAAAANSUgAAADAAAAAwCAAAABXAvnHAAAPKLEQVRo3u2aaZSU1ZnHf/e+71vV1dXkFHQ03UznqATYgKILJko0ESDYU4S18UjkeNZ1Q8a1Yz1c1oJ3kxaoJHGJmJYn0XFB4gLaSNjM8SZUICqgrN3NQLP8B:
6  "version_code":"352975","certificate_base64":[
7  "MIIBqzCCARsgAwIBAgIES/p1jDANBgkqhkiG9w0BAQUFADAAwRgwfGyYDVQQKEw9TcGFyYXV1dXkFHQ03UznqATYgKILJko0ESDYU4S18UjkeNZ1Q8a1Yz1c1oJ3kxaoJHGJmJYn0XFB4gLaSNjM8SZUICqgrN3NQLP8B:
8  "file_size":"25916262","externally_hosted_url":
9  "https://a1wtest-xmdev.citrix.com:4443/Citrix/v1/download/app/MobileApp23",
10 "version_name":"10.3.0","minimum_sdk":"14"}
11

```

6. Copy the **file_sha1_base64** value and use it in the **Hash** field in the Provisioning Tool. **Note:** The hash must be URL safe.

- Convert any + symbols to _
- Convert any / symbols to _

- Replace the trailing `\u003d` with `=`

If you store the hash in the `nfcprovisioning.txt` file on the SD card of the device, the app does the safety conversion. However, if you opt to type the hash manually, it's your responsibility to ensure its URL safety.

Libraries used

The Provisioning Tool uses the following libraries in its source code:

- [v7 appcompat library](#) by Google under Apache license 2.0
- [Design support library](#) by Google under Apache license 2.0
- [v7 Palette library](#) by Google under Apache license 2.0
- [Butter Knife](#) by Jake Wharton under Apache license 2.0

Bulk enrollment of iOS and macOS devices

Jun 19, 2017

You can enroll large numbers of iOS and macOS devices in XenMobile in two ways.

- You can use the Apple Device Enrollment Program (DEP) to enroll the iOS and macOS devices that you buy directly from Apple, a participating Apple Authorized Reseller, or a carrier.

For DEP enrollment of macOS devices, XenMobile requires that the devices run OS X 10.10 or later.

- Or you can use the Apple Configurator to enroll iOS devices whether or not you purchased them directly from Apple.

With DEP, you do not have to touch or prepare the devices. Instead, you submit device serial numbers or purchase order numbers through DEP to configure and enroll the devices. After XenMobile enrolls the devices, you can give them to users who can start using them right out of the box. In addition, when you set up devices with DEP, you can eliminate some of the Setup Assistant steps that users would otherwise have to complete when they first start their devices. For more information on setting up DEP, see the Apple [Device Enrollment Program](#) page.

With the Apple Configurator, you attach iOS devices to an Apple computer running OS X 10.7.2 or later and the Apple Configurator 2 app. You prepare the iOS devices and configure policies through Apple Configurator 2. After you provision the devices with the required policies, the first time the devices connect to XenMobile, the devices receive policies from XenMobile. You can then start managing the devices. For more information about using Apple Configurator, see the [Apple Configurator](#) help.

Important

You must open required ports for connectivity between XenMobile and Apple. For more information, see [Port requirements](#).

Integrate your Apple DEP account with XenMobile

If you do not have an Apple DEP account, see [Deploy iOS and macOS devices through Apple DEP](#).

To connect your Apple DEP account with your XenMobile server deployment, you enter information in the XenMobile console and the Apple DEP Portal, as described in the following steps.

Step 1: Download a public key from your XenMobile server

1. Log on to the XenMobile console and go to **Settings > Apple Device Enrollment Program (DEP)**.

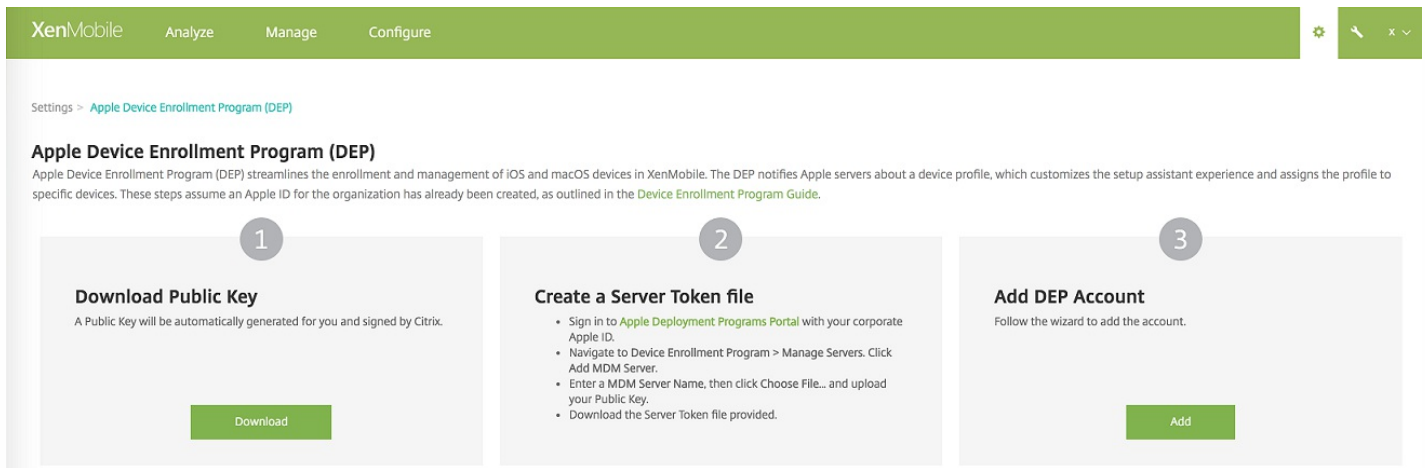

2. Under **Download Public Key**, click **Download**.

Step 2: Create and download a server token file from your Apple account

1. Using your corporate Apple ID, log on to the [Apple Deployment Program Portal](#).

2. In the Apple DEP Portal, click **Device Enrollment Program**.

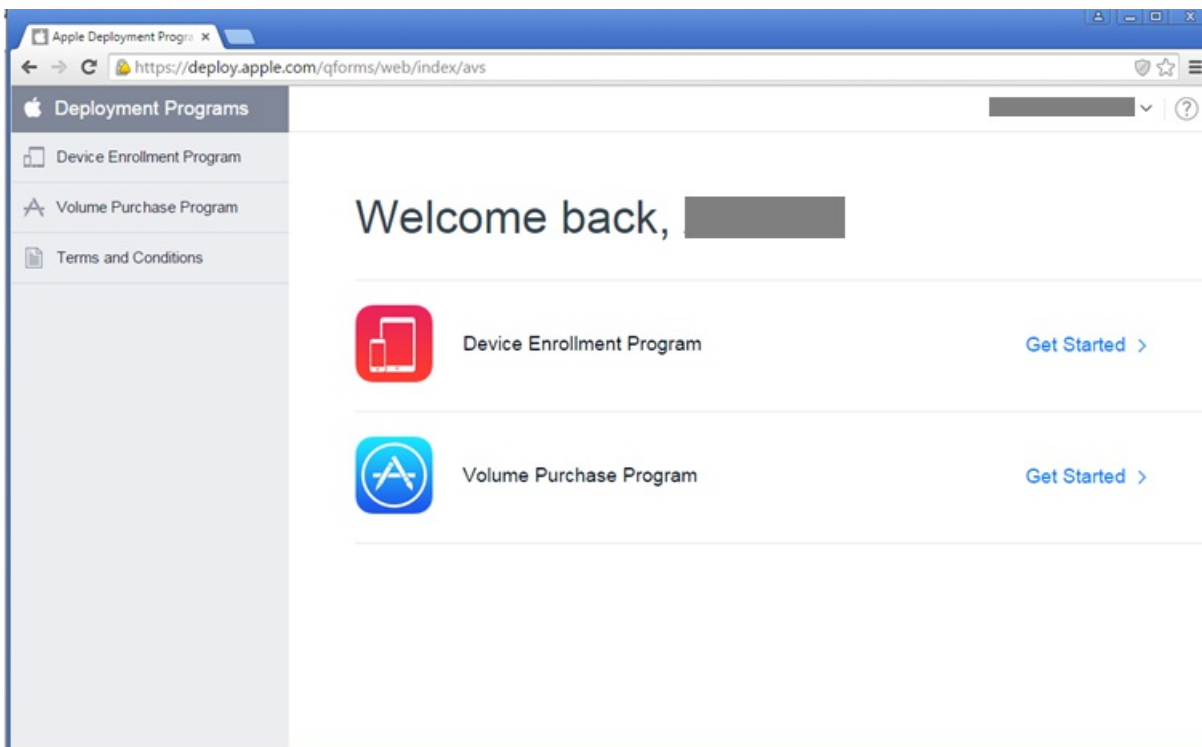

3. Click **Manage Servers** and then on the right side, click **Add MDM Server**.

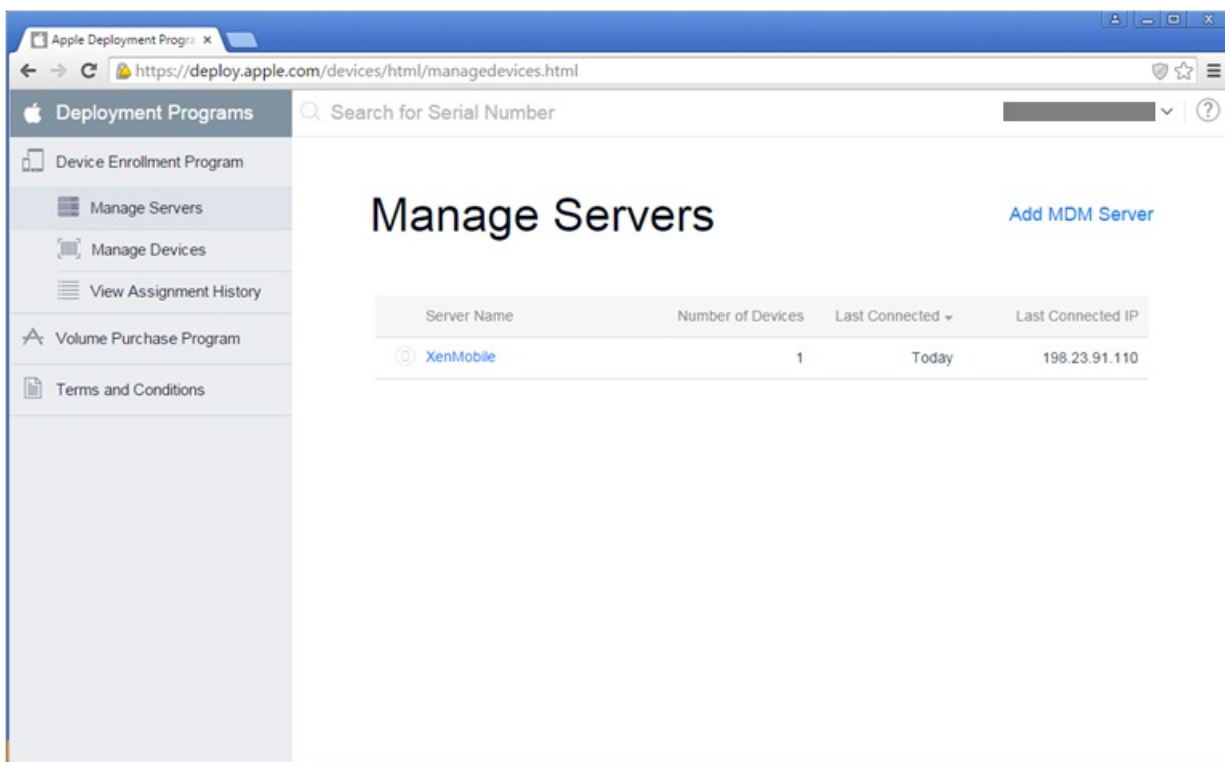

4. In **Add MDM Server**, enter a name for your XenMobile server and then click **Next**.

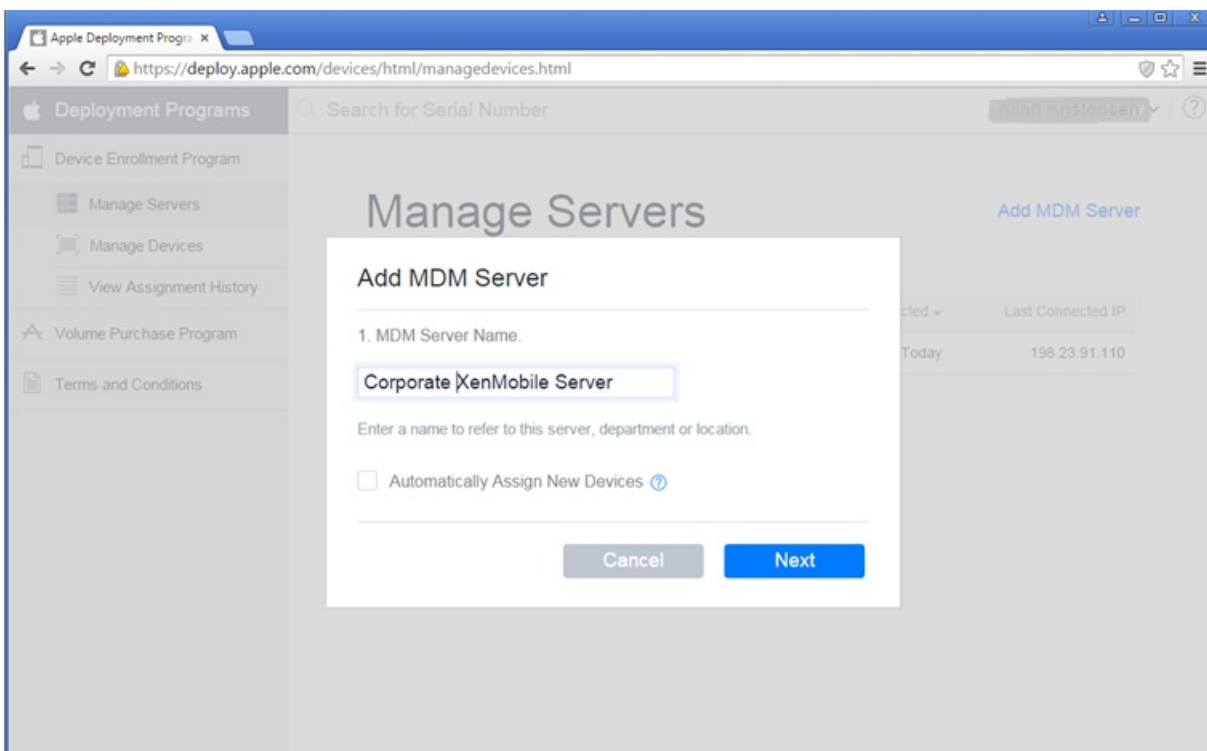

5. On the Apple DEP Portal, click **Choose file**, choose the public key you downloaded from XenMobile, and click **Next**.

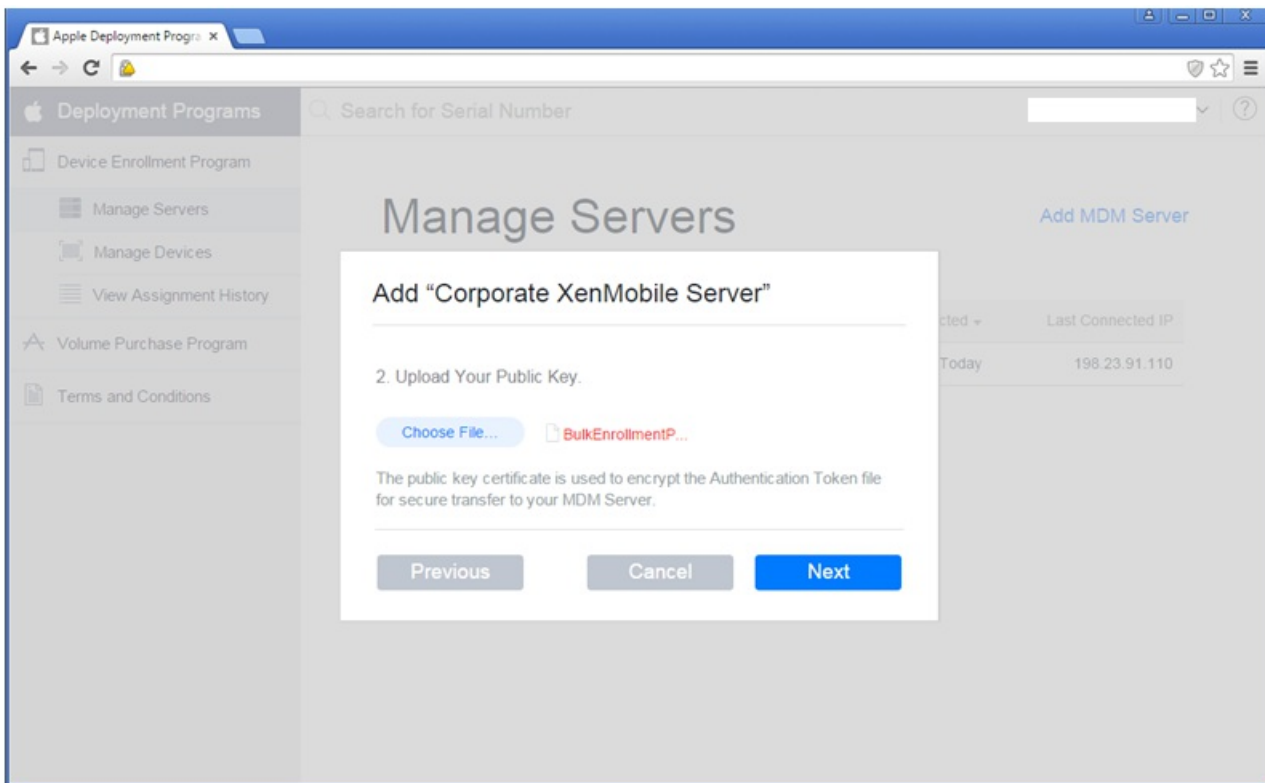

6. Click **Your Server Token** to generate a server token, which downloads from the browser, and then click **Done**.

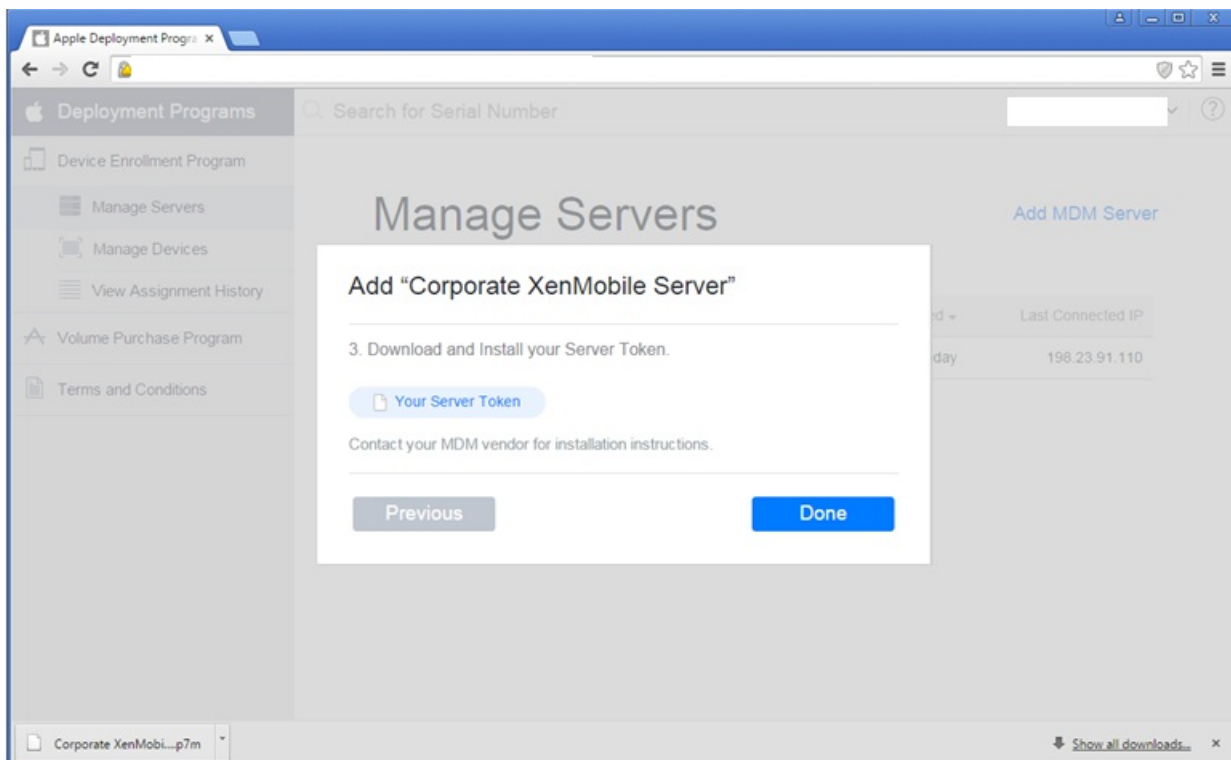

Your Apple DEP token information appears in the XenMobile console after you import the token file. You will upload the server token file when adding the DEP account to XenMobile.

Step 3: Add a DEP account to XenMobile

You can add multiple DEP accounts to XenMobile. This feature enables you to use different enrollment settings and setup assistant options by country, department, and so on. You then associate DEP accounts with different device policies.

For example, you might centralize all of your DEP accounts from different countries on the same XenMobile server, to import and supervise all DEP devices. By customizing enrollment settings and setup assistant options per department, organizational hierarchy, or other structure, you can ensure that policies provide appropriate functionality across your organization and that device users receive the appropriate setup assistance.

1. In XenMobile console, go to **Settings > Apple Device Enrollment Program (DEP)** and, under **Add DEP Account**, click **Add**.

XenMobile Analyze Manage Configure

Settings > Apple Device Enrollment Program (DEP)

Apple Device Enrollment Program (DEP)

Apple Device Enrollment Program (DEP) streamlines the enrollment and management of iOS and macOS devices in XenMobile. The DEP notifies Apple servers about a device profile, which customizes the setup assistant experience and assigns the profile to specific devices. These steps assume an Apple ID for the organization has already been created, as outlined in the [Device Enrollment Program Guide](#).

- Download Public Key**
A Public Key will be automatically generated for you and signed by Citrix.
[Download](#)
- Create a Server Token file**
 - Sign in to [Apple Deployment Programs Portal](#) with your corporate Apple ID.
 - Navigate to Device Enrollment Program > Manage Servers. Click Add MDM Server.
 - Enter a MDM Server Name, then click Choose File... and upload your Public Key.
 - Download the Server Token file provided.
- Add DEP Account**
Follow the wizard to add the account.
[Add](#)

2. In the **Account Info** page, specify these settings:

XenMobile Analyze Manage Configure

Settings > Apple Device Enrollment Program (DEP) > [Edit DEP Account](#)

DEP Account

- 1 Account Info
- 2 Server Tokens
- 3 Settings
- iOS
- macOS

Account Info

Specify your Apple DEP account information.

DEP account name*

Business unit*

Unique service ID

Support phone number*

Support email address

- **DEP account name:** A unique name for this DEP account. Use names that reflect how you organize DEP accounts, such as by country or organizational hierarchy.
- **Business unit:** The business unit or department to which the device is assigned. This field is required.

- **Unique service ID:** An optional unique ID to help you further identify the account.
- **Support phone number:** A support phone number that users may call for help during setup. This field is required.
- **Support email address:** An optional support email address available to end users.

3. In the **Server Tokens** page, specify your server token file and then click **Upload**.

The screenshot shows the XenMobile interface for configuring a DEP Account. The top navigation bar includes 'XenMobile', 'Analyze', 'Manage', and 'Configure'. The breadcrumb trail is 'Settings > Apple Device Enrollment Program (DEP) > Edit DEP Account'. The left sidebar shows the 'DEP Account' section with sub-items: '1 Account Info', '2 Server Tokens' (highlighted), '3 Settings', 'iOS', 'macOS', '4 Setup Assistant Options', 'iOS', and 'macOS'. The main content area is titled 'Server Tokens' and includes the instruction: 'Upload the Server Token file that you downloaded from Apple DEP portal.' Below this is a 'Select Server Token file*' input field with an 'Upload' button. A list of fields follows: 'Consumer key', 'Consumer secret', 'Access token', 'Access secret', 'Access token expiration', 'Server name', 'Server UUID', 'Apple admin ID', 'Organization name', 'Organization email', 'Organization phone', and 'Organization address'. At the bottom right, there are 'Back' and 'Next >' buttons.

Your server token information appears.

4. In **iOS Settings**, specify these settings:

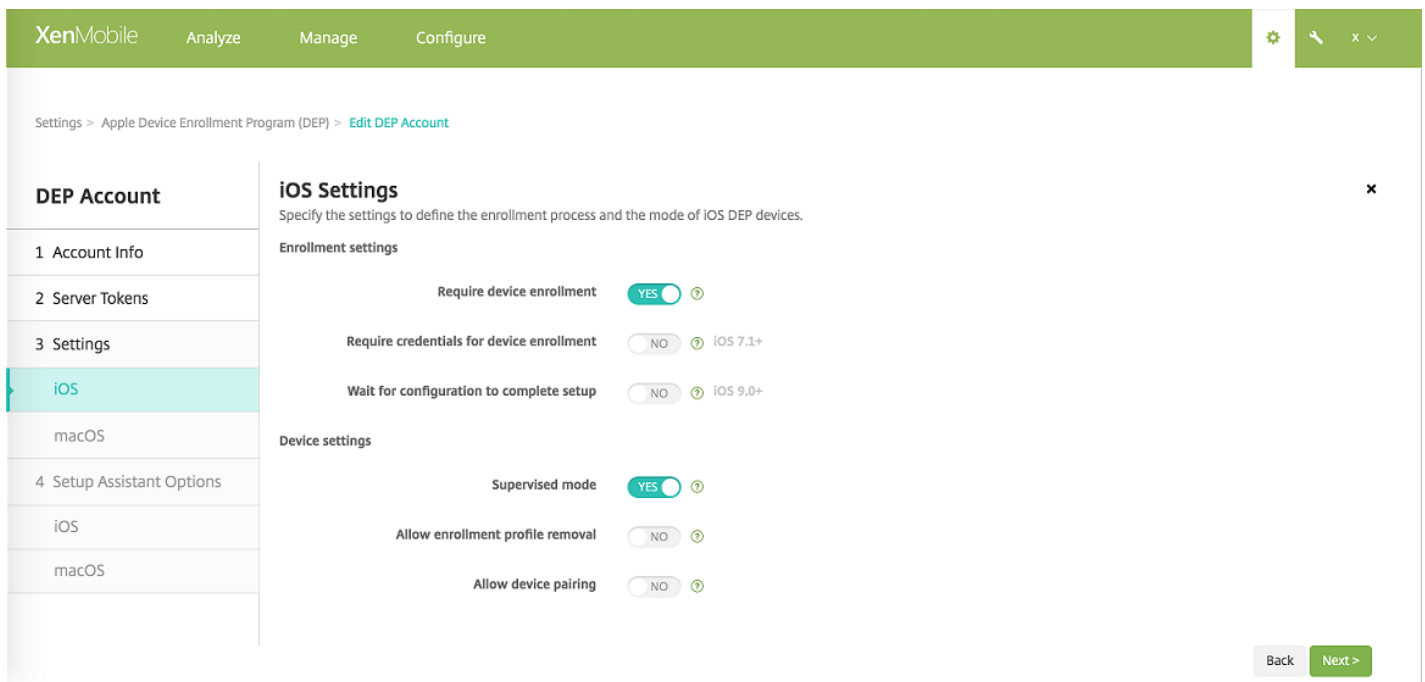

Enrollment settings

- **Require device enrollment:** Whether to require users to enroll their devices. The default is **Yes**.
- **Require credentials for device enrollment:** Whether to require users to enter their credentials during DEP set up. This feature is available for iOS 7.1 and higher. The default is **No**.
 Note: When DEP is on for the first time setup and you don't select this option, the DEP components, such as DEP user, Secure Hub, software inventory, and DEP deployment group, are created. If you do select this option, XenMobile doesn't create the components. As a result, if you later clear this option, users who have not entered their credentials cannot perform the DEP enrollment because these DEP components do not exist. To add DEP components, in that case, you should disable and enable the DEP account.
- **Wait for configuration to complete setup:** Whether to require users' devices to remain in Setup Assistant mode until all MDM resources deploy to the device. This is available for iOS 9.0 and higher devices in supervised mode. The default is **No**.
 - Apple documentation states that the following commands may not work while a device is in Setup Assistant mode:
 - InviteToProgram
 - InstallApplication
 - ApplyRedemptionCode
 - InstallMedia
 - RequestMirroring
 - DeviceLock

Device settings

- **Supervised mode:** Must be set to **Yes** if you are using the Apple Configurator to manage DEP enrolled devices or when **Wait for configuration to complete setup** is enabled. The default is **Yes**. For details on placing an iOS device in supervised mode, see [To place an iOS device in Supervised mode by using the Apple Configurator](#).
- **Allow enrollment profile removal:** Whether to allow devices to use a profile that you can remove remotely. The default is **No**.
- **Allow device pairing:** For devices enrolled through DEP, whether you can manage them through iTunes and the Apple

Configurator. The default is **No**.

5. In **macOS Settings**, specify these settings:

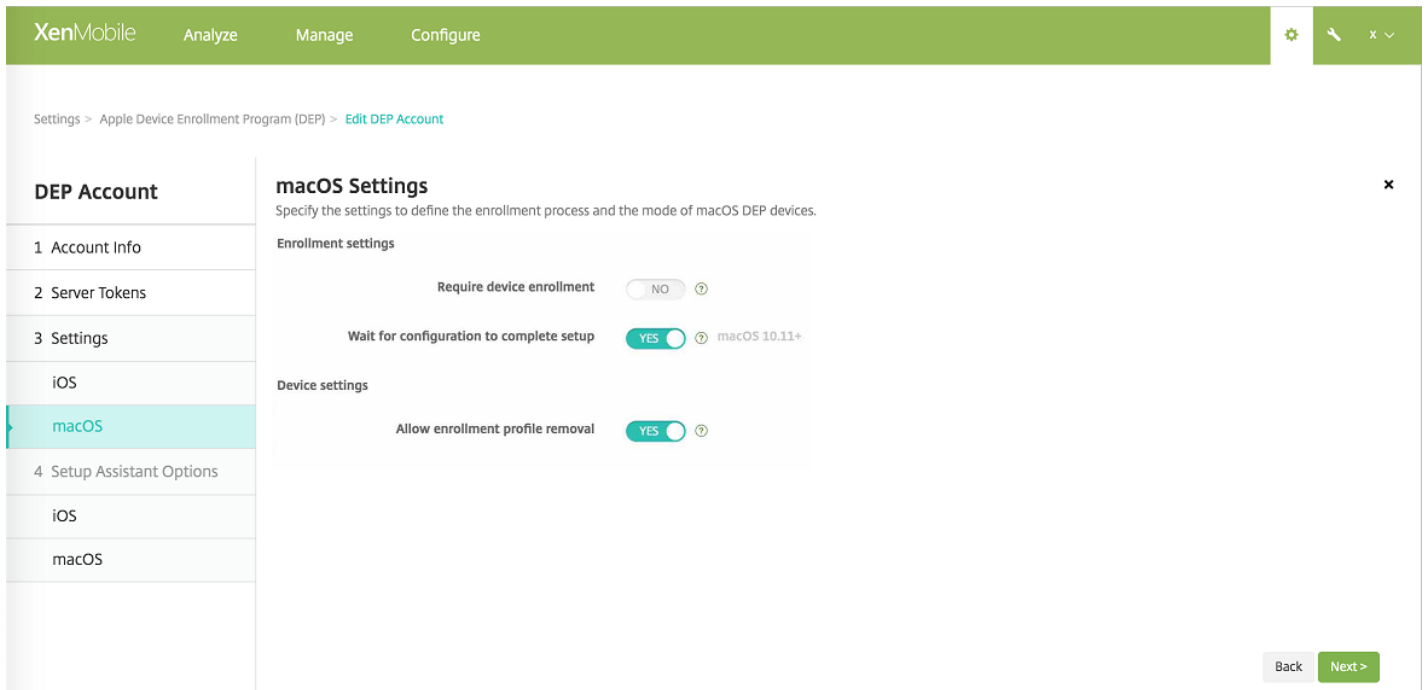

Enrollment settings

- **Require device enrollment:** Whether to require users to enroll their devices. The default is **Yes**.
- **Wait for configuration to complete setup:** If **Yes**, the macOS device doesn't continue in the setup assistant until the MDM resource passcode gets deployed to the device. That deployment occurs before the creation of the local account. This is available for macOS 10.11 and higher devices. The default is **No**.

Device settings

- **Allow enrollment profile removal:** Whether to allow devices to use a profile that you can remove remotely. The default is **No**.

6. In **iOS Setup Assistant Options**, select the iOS Setup Assistant steps that your users will not have to take (that is, steps that are skipped) when they start their devices the first time. The default for all items is unchecked.

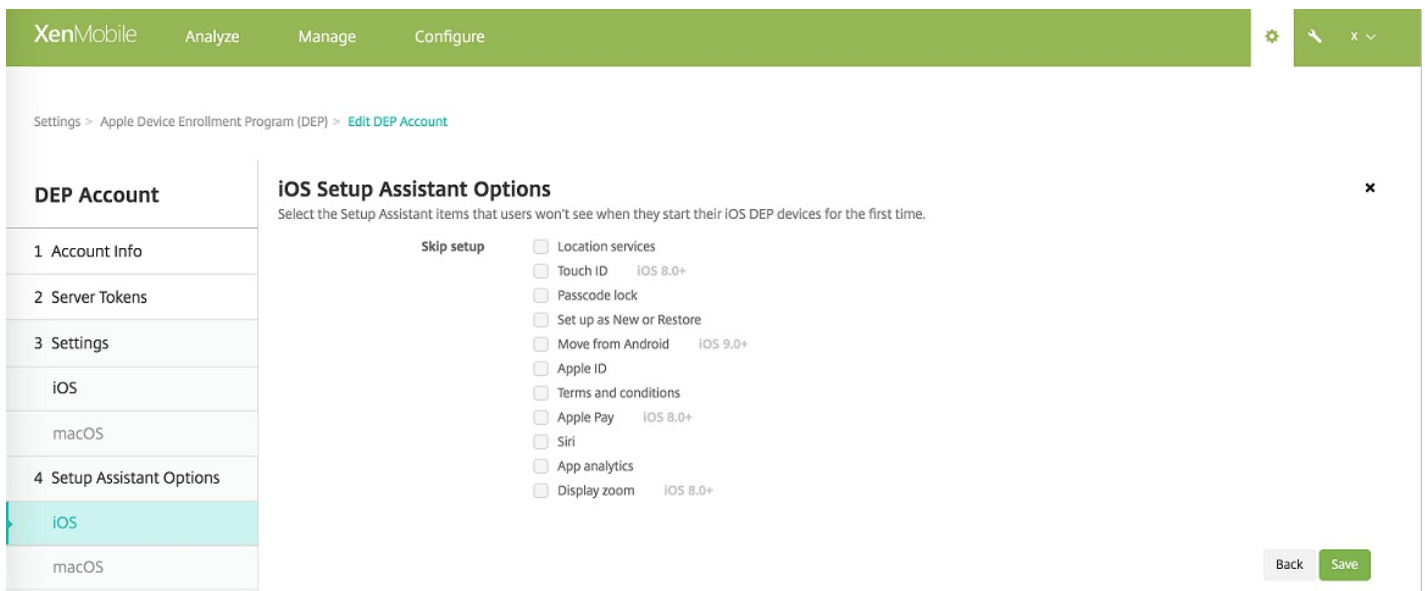

- **Location services:** Set up the location service on the device.
- **Touch ID:** Set up Touch ID on iOS 8.0 and later devices.
- **Passcode lock:** Create a passcode for the device.
- **Set up as New or Restore:** Set up the device as new or from an iCloud or iTunes backup.
- **Move from Android:** Enable transferring data from an Android device to an iOS 9 or later device. This option is available only when **Set up as New or Restore** is selected (that is, the step is skipped).
- **Apple ID:** Set up an Apple ID account for the device.
- **Terms and conditions:** Require users to accept terms and conditions for use of the device.
- **Apple Pay:** Set up Apple Pay on iOS 8.0 and later devices.
- **Siri:** Use or not use Siri on the device.
- **App analytics:** Set up whether to share crash data and usage statistics with Apple.
- **Display zoom:** Set up the display resolution (either standard or zoomed) on iOS 8.0 or later devices.

The DEP account appears on **Settings > Apple Device Enrollment Program (DEP)**.

7. In **macOS Setup Assistant Options**, select the macOS Setup Assistant steps that your users will not have to take (that is, steps that are skipped) when they start their devices the first time. The default for all items is unchecked.

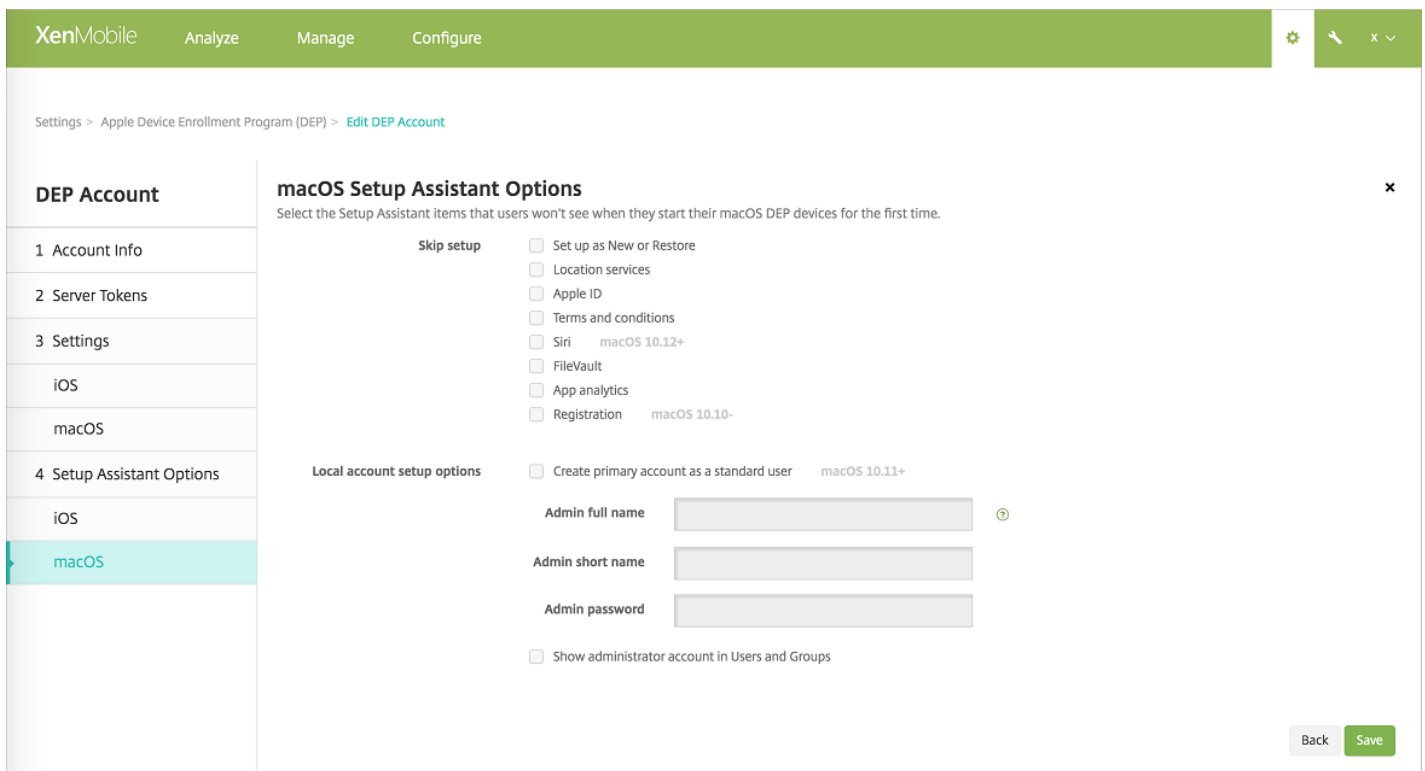

- **Set up as New or Restore:** Set up the device as new or from an iCloud or iTunes backup.
- **Location services:** Set up the location service on the device.
- **Apple ID:** Set up an Apple ID account for the device.
- **Terms and conditions:** Require users to accept terms and conditions for use of the device.
- **Siri:** Use or not use Siri on the device.
- **FileVault:** Use FileVault to encrypt the startup disk. XenMobile applies the FileVault setting only if the system has a single local user account and that account is signed into iCloud.

Note: You can use the macOS FileVault Disk Encryption feature to protect the system volume by encrypting its contents (<https://support.apple.com/en-us/HT204837>). If you run the Setup assistant on a late-model portable Mac that doesn't have FileVault turned on, you might be prompted to turn on this feature. The prompt appears on both new systems and systems upgraded to OS X 10.10 or 10.11, but only if the system has a single local administrator account and that account is signed into iCloud.

- **App analytics:** Set up whether to share crash data and usage statistics with Apple.
- **Registration:** Require users to register their device.

Registration information setup was available through OS X 10.9. The registration process allowed you to send system registration information to Apple. This information associated your contact information with the Mac hardware. Apple primarily used the information to facilitate AppleCare support. If you previously entered an Apple ID, Setup Assistant optionally submitted the registration based on your Apple ID account. If you didn't enter an Apple ID, you could manually enter your contact information.

Under **Local account setup options**, specify the settings to create an administrator account, which is required for macOS. XenMobile creates the account, using the specified information.

8. To test connectivity between XenMobile and Apple, select the account and click **Test Connectivity**.

Apple Device Enrollment Program (DEP)

Apple Device Enrollment Program (DEP) streamlines the enrollment and management of iOS and macOS devices in XenMobile. The DEP notifies Apple servers about a device profile, which customizes the setup assistant experience and assigns the profile to specific devices. These steps assume an Apple ID for the organization has already been created, as outlined in the [Device Enrollment Program Guide](#).

- Download Public Key**
A Public Key will be automatically generated for you and signed by Citrix.
[Download](#)
- Create a Server Token file**
 - Sign in to [Apple Deployment Programs Portal](#) with your corporate Apple ID.
 - Navigate to Device Enrollment Program > Manage Servers. Click [Add MDM Server](#).
 - Enter a MDM Server Name, then click [Choose File...](#) and upload your Public Key.
 - Download the Server Token file provided.
- Add DEP Account**
Follow the wizard to add the account.
[Add](#)

<input type="checkbox"/>	Account name	Business unit	Created on	Status	Apple admin ID	Organization email	Server token expires on
<input type="checkbox"/>	DEP Account FR	CITRIX SYSTEMS FR (mdm.fducos.fr)	06/13/2016 12:49:44 pm	Enabled	XMFrdEPAdm@outlook.com	XMFrdEPAdm@outlook.com	06/13/2017 07:44:57 pm
<input checked="" type="checkbox"/>	DEP Account US	CITRIX SYSTEMS US (dev.paris)	06/13/2016 12:20:02 pm	Enabled	citrixxenmobilevpp@outlook.com	CitrixXenmobileVPP@outlook.com	06/14/2017 12:45:21 am
<input type="checkbox"/>	DEP Account US 2	CITRIX SYSTEMS US 2 (mdm.fducos.fr)	07/11/2016 11:20:01 am	Enabled	citrixxenmobilevpp@outlook.com	CitrixXenmobileVPP@outlook.com	07/11/2017 06:17:43 pm

Showing 1 - 3 of 3 items

A status message appears.

Test Connectivity

✓ Connection Successful

[OK](#)

Settings > [Apple Device Enrollment Program \(DEP\)](#)

Apple Device Enrollment Program (DEP)

Apple Device Enrollment Program (DEP) streamlines the enrollment and management of iOS and macOS devices in XenMobile. The DEP notifies Apple servers about a device profile, which customizes the setup assistant experience and assigns the profile to specific devices. These steps assume an Apple ID for the organization has already been created, as outlined in the [Device Enrollment Program Guide](#).

- Download Public Key**
A Public Key will be automatically generated for you and signed by Citrix.
[Download](#)
- Create a Server Token file**
 - Sign in to [Apple Deployment Programs Portal](#) with your corporate Apple ID.
 - Navigate to Device Enrollment Program > Manage Servers. Click [Add MDM Server](#).
 - Enter a MDM Server Name, then click [Choose File...](#) and upload your Public Key.
 - Download the Server Token file provided.
- Add DEP Account**
Follow the wizard to add the account.
[Add](#)

<input type="checkbox"/>	Account name	Business unit	Created on	Status	Apple admin ID	Organization email	Server token expires on
<input type="checkbox"/>	DEP Account FR	CITRIX SYSTEMS FR (mdm.fducos.fr)	06/13/2016 12:49:44 pm	Enabled	XMFrdEPAdm@outlook.com	XMFrdEPAdm@outlook.com	06/13/2017 07:44:57 pm
<input checked="" type="checkbox"/>	DEP Account US	CITRIX SYSTEMS US (dev.paris)	06/13/2016 12:20:02 pm	Enabled	citrixxenmobilevpp@outlook.com	CitrixXenmobileVPP@outlook.com	06/14/2017 12:45:21 am
<input type="checkbox"/>	DEP Account US 2	CITRIX SYSTEMS US 2 (mdm.fducos.fr)	07/11/2016 11:20:01 am	Enabled	citrixxenmobilevpp@outlook.com	CitrixXenmobileVPP@outlook.com	07/11/2017 06:17:43 pm

Showing 1 - 3 of 3 items

Configure deployment rules of device policies and

apps for DEP accounts

You can associate DEP accounts with different device policies and apps by using the **Deployment Rules** section under **Configure > Device Policies** and **Configure > Apps**. You can specify that a policy or app either:

- Deploys only for a particular Apple DEP account.
- Deploys for all Apple DEP accounts except the one selected.

The list of DEP accounts includes only those accounts with a status of enabled or disabled. If the DEP account is disabled, the DEP device doesn't belong to this account. Therefore, XenMobile doesn't deploy the app or policy to the device.

In the following example, the MDM Options policy for iOS deploys to devices except for those with the Apple DEP account "DEP Account US".

The screenshot shows the XenMobile configuration interface. The top navigation bar includes 'XenMobile', 'Analyze', 'Manage', and 'Configure'. Below this, there are tabs for 'Device Policies', 'Apps', 'Actions', 'ShareFile', 'Enrollment Profiles', and 'Delivery Groups'. The main content area is titled 'MDM Options Policy' and includes a sidebar with '1 Policy Info', '2 Platforms', '3 Assignment', and 'iOS' (selected). The 'Policy Information' section states: 'This policy lets you specify the MDM options setting to be applied on the device.' Below this, there is a toggle for 'Enable activation lock' (ON) and the text 'iOS 7.0+, Supervised only.' The 'Deployment Rules' section is expanded, showing 'Base' and 'Advanced' tabs. The 'Deploy when' section has a dropdown set to 'All' and the text 'conditions are met.' A 'New Rule' button is present. Below this, there is a dropdown for 'Apple DEP account' and a dropdown for 'except' with a list of options: 'DEP Account US', 'DEP Account FR', 'DEP Account US', and 'DEP Account US 2'. At the bottom right, there are 'Back' and 'Next >' buttons.

In the following example, a public app store app for iPhone deploys only for devices with the Apple DEP account "DEP Account US".

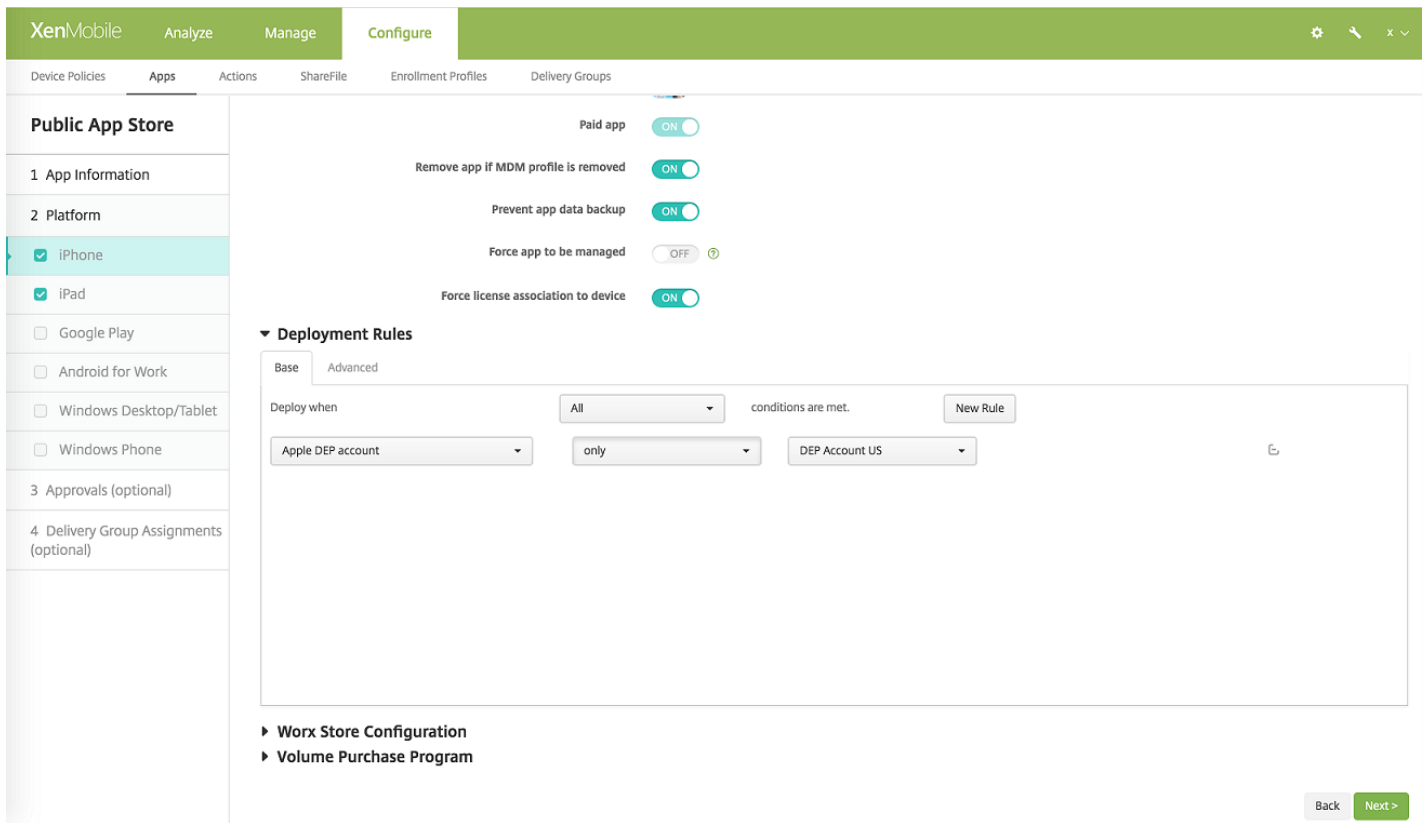

Configure Apple Configurator settings

1. In the XenMobile console, go to **Settings > Apple Configurator Device Enrollment**.

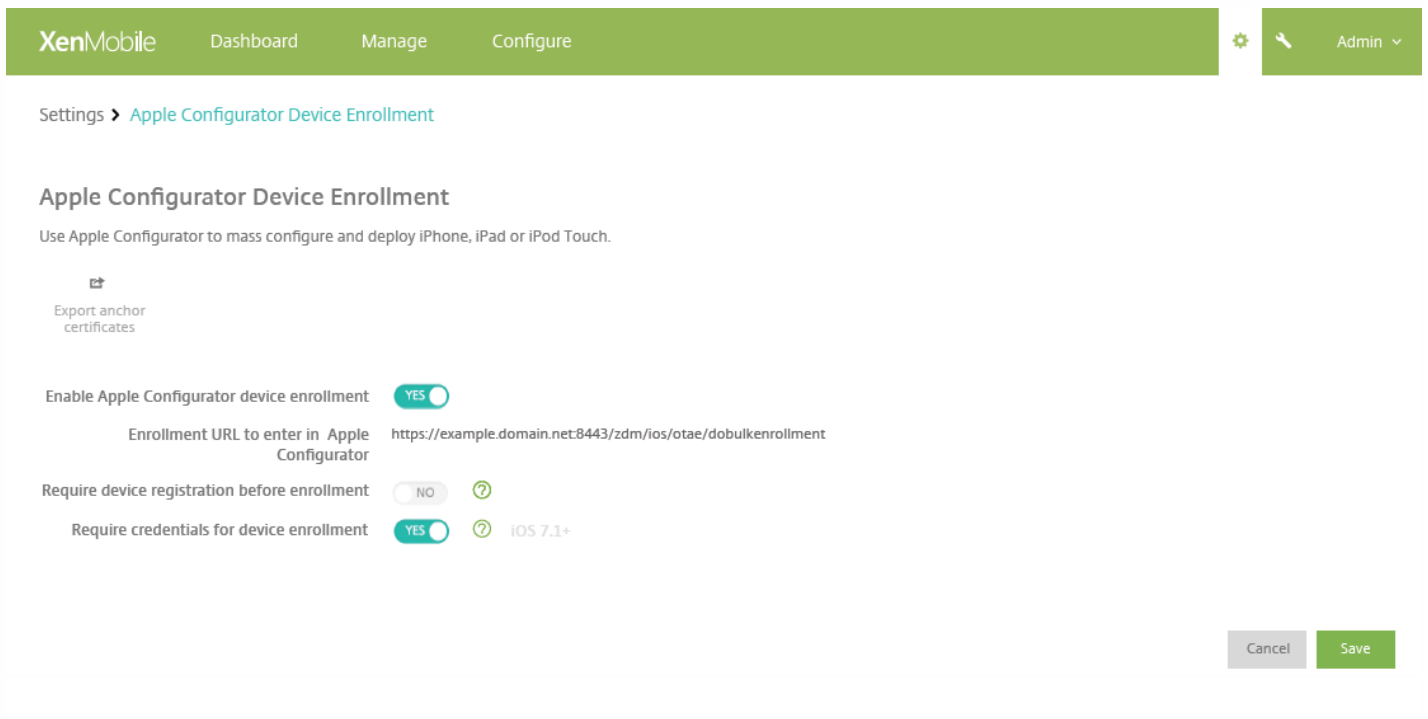

2. Set **Enable Apple Configurator device enrollment** to **Yes**.

3. The **Enrollment URL to enter in Apple Configurator** is a read-only field. This is the URL for the XenMobile server that communicates with Apple. Later in these steps, you copy and paste the URL into the Apple Configurator. In Apple Configurator 2, the enrollment URL is the XenMobile server fully qualified domain name (FQDN), such as `mdm.server.url.com`, or the IP address.

4. To prevent unknown devices from enrolling, set **Require device registration before enrollment** to **Yes**. Note: If this setting is **Yes**, you must add the configured devices to **Manage > Devices** in XenMobile manually or through a CSV file before enrollment.

5. To require users of iOS 7.1 and later devices to enter their credentials when enrolling, set **Require credentials for device enrollment** to **Yes**. The default is not to require credentials for enrollment.

6. Note: If the XenMobile server is using a trusted SSL certificate, skip this step. Click **Export anchor certs** and save the `certchain.pem` file to the OS X keychain (login or System).

XenMobile Dashboard Manage Configure Admin

Settings > Apple Configurator Device Enrollment

Apple Configurator Device Enrollment

Use Apple Configurator to mass configure and deploy iPhone, iPad or iPod Touch.

Export anchor certificates

Enable Apple Configurator device enrollment YES

Enrollment URL to enter in Apple Configurator `https://example.domain.net:8443/zdm/ios/otae/dobulkenrollment`

Require device registration before enrollment NO ?

Require credentials for device enrollment YES ? iOS 7.1+

Cancel Save

7. Start the Apple Configurator and go to **Prepare > Setup > Configure Settings**.

8. In the **Device Enrollment** setting, paste the MDM server URL from step 4 into the **MDM server URL** box in the Configurator.

9. In the **Device Enrollment** setting, copy the Root Certificate Authority and SSL Servers Certificate Authority to the **Anchor** certificates, if XenMobile isn't using a trusted SSL certificate.

10. Use a Dock Connector-to-USB cable to connect devices to the Mac running the Apple Configurator to configure up to 30 connected devices simultaneously. If you do not have a Dock Connector, use one or more powered USB 2.0 high-speed hubs to connect the devices.

11. Click **Prepare**. For more information on preparing devices with the Apple Configurator, see the Apple Configurator help page, [Prepare devices](#).

12. In the Apple Configurator, configure the device policies you require.

13. As each device is prepared, turn it on to start the iOS Setup Assistant, which prepares the device for first-time use.

To renew or update certificates when using the Apple DEP

When the XenMobile Secure Sockets Layer (SSL) certificate is renewed, you upload a new certificate in the XenMobile console in **Settings > Certificates**. In the **Import** dialog box, in **Use as**, be sure to click **SSL Listener** so that the certificate is used for SSL. After you restart the server, XenMobile uses the new SSL certificate. For more information about certificates in XenMobile, see [Uploading Certificates in XenMobile](#).

It is not necessary to reestablish the trust relationship between Apple DEP and XenMobile when you renew or update the SSL certificate. You can, however, reconfigure your DEP settings at any time by following the preceding steps in this article.

For more information about Apple DEP, see the [Apple documentation](#).

To place an iOS device in Supervised mode by using the Apple Configurator

Important

Placing a device into Supervised mode will install the selected version of iOS on the device, completely wiping the device of any previously stored user data or apps.

1. Install [Apple Configurator](#) from iTunes.
2. Connect the iOS device to your Apple computer.
3. Start Apple Configurator. The Configurator shows that you have a device to prepare for supervision.
4. To prepare the device for supervision:
 - a. Set the **Supervision control** to **On**. Citrix recommends that you choose this setting if you intend to maintain control of the device by reapplying a configuration regularly.
 - b. Optionally, provide a name for the device.
 - c. In iOS, click **Latest** for the latest version of iOS that you want to install.
5. When you are ready to prepare the device for supervision, click **Prepare**.

Client properties

Aug 08, 2017

Client properties contain information that is provided directly to Secure Hub on user devices. You can use these properties to configure advanced settings, such as the Citrix PIN. You obtain client properties from Citrix support.

Client properties are subject to change with every release of Secure Hub and occasionally for client apps. For details about more commonly configured client properties, see [Client property reference](#), later in this article.

1. In the XenMobile console, click the gear icon in the upper-right corner. The **Settings** page appears.
2. Under **Client**, click **Client Properties**. The **Client Properties** page appears. You can add, edit, and delete client properties from this page.

Settings > Client Properties

Client Properties

To change a property, select the property and then click Edit.

Add

<input type="checkbox"/>	Name	Key	Value	Description
<input type="checkbox"/>	Enable Citrix PIN Authentication	ENABLE_PASSCODE_AUTH	false	Enable Citrix PIN Authentication
<input type="checkbox"/>	Enable User Password Caching	ENABLE_PASSWORD_CACHING	false	Enable User Password Caching
<input type="checkbox"/>	Encrypt secrets using Passcode	ENCRYPT_SECRETS_USING_PASSCODE	false	Encrypt secrets using Pin or AD password
<input type="checkbox"/>	PIN Strength Requirement	PASSCODE_TYPE	Numeric	PIN Strength Requirement
<input type="checkbox"/>	PIN Type	PASSCODE_STRENGTH	Medium	PIN Type
<input type="checkbox"/>	PIN Length Requirement	PASSCODE_MIN_LENGTH	6	PIN Length Requirement
<input type="checkbox"/>	PIN Change Requirement	PASSCODE_EXPIRY	90	PIN Change Requirement
<input type="checkbox"/>	PIN History	PASSCODE_HISTORY	5	PIN History
<input type="checkbox"/>	Inactivity Timer	INACTIVITY_TIMER	15	Inactivity Timer
<input type="checkbox"/>	Enable FIPS Mode	ENABLE_FIPS_MODE	false	Enable FIPS Mode

To add a client property

1. Click **Add**. The **Add New Client Property** page appears.

XenMobile Analyze Manage Configure admin

Settings > Client Properties > Add New Client Property

Add New Client Property

Key ?

Value*

Name*

Description*

Cancel Save

2. Configure these settings:

- **Key:** In the list, click the property key that you want to add. **Important:** Contact Citrix Support before updating the settings. You can request a special key.
- **Value:** The value of the selected property.
- **Name:** A name for the property.
- **Description:** A description of the property.

3. Click **Save**.

To edit a client property

1. In the **Client Properties** table, select the client property you want to edit.

Note: When you select the check box next to a client property, the options menu appears above the client property list. When you click anywhere else in the list, the options menu appears on the right side of the listing.

2. Click **Edit**. The **Edit Client Property** page appears.

Settings > Client Properties > Edit Client Property

Edit Client Property

Key

Value*

Name*

Description*

3. Change the following information as appropriate:

- **Key:** You cannot change this field.
- **Value:** The property value.
- **Name:** The property name.
- **Description:** The property description.

4. Click **Save** to save your changes or **Cancel** to leave the property unchanged.

To delete a client property

1. In the **Client Properties** table, select the client property you want to delete.

Note: You can select more than one property to delete by selecting the check box next to each property.

2. Click **Delete**. A confirmation dialog box appears. Click **Delete** again.

Client property reference

The XenMobile predefined client properties and their default settings are as follows.

CONTAINER_SELF_DESTRUCT_PERIOD

Display name: MDX Container Self Destruct Period

Self-destruct prevents access to Secure Hub and managed apps, after a specified number of days of inactivity. After the time limit, apps are no longer usable. Wiping the data includes clearing the app data for each installed app, including the app cache and user data. The inactivity time is when the server does not receive an authentication request to validate the user over a specific length of time. For example, if this property is 30 days and the user doesn't use the apps for more than 30 days, the policy takes effect.

This global security policy applies to iOS and Android platforms and is an enhancement of the existing app lock and wipe policies.

To configure this global policy, go to **Settings > Client Properties** and add the custom key **CONTAINER_SELF_DESTRUCT_PERIOD**.

Value: Number of days

DEVICE_LOGS_TO_IT_HELP_DESK

Display name: Send device logs to IT help desk

This property enables or disables the ability to send logs to the IT help desk.

Possible values: **true** or **false**

Default value: **false**

DISABLE_LOGGING

Display name: Disable Logging

Use this property to prevent users from collecting and uploading logs from their devices. This property disables logging for Secure Hub and for all installed MDX apps. Users can't send logs for any app from the Support page. Even though the mail composition dialog box appears, logs aren't attached. A message indicates that logging is disabled. This setting also prevents you from updating log settings in the XenMobile console for Secure Hub and MDX apps.

When this property is set to **true**, Secure Hub sets **Block application logs** to **true**. As a result, MDX apps stop logging when the new policy is applied.

Possible values: **true** or **false**

Default value: **false** (logging is not disabled)

ENABLE_CRASH_REPORTING

Display name: Enable Crash Reporting

If **true**, Citrix collects crash reports and diagnostics to help troubleshoot issues with Secure Hub for iOS and Android. If **false**, no data is collected.

Possible values: **true** or **false**

Default value: **true**

ENABLE_CREDENTIAL_STORE

Display name: Enable Credential Store

Enabling the credential store means that Android or iOS users enter their password one time when accessing XenMobile Apps. You can use the credential store whether or not you enable Citrix PIN. If you don't enable Citrix PIN, users enter their Active Directory password. XenMobile supports use of Active Directory passwords with the credential store only for Secure Hub and public store apps. If you use Active Directory passwords with the credential store, XenMobile doesn't support PKI authentication.

Automatic enrollment in Secure Mail requires that you set this property to **true**.

To configure this custom client policy, go to **Settings > Client Properties**, add the custom key **ENABLE_CREDENTIAL_STORE**, and set the **Value** to **true**.

ENABLE_FIPS_MODE

Display name: Enable FIPS Mode

This property enables or disables FIPS mode on mobile devices. After you change the value, Secure Hub passes the new value to the device when Secure Hub does the next online authentication.

Possible values: **true** or **false**

Default value: **false**

ENABLE_NETWORK_EXTENSION

Display name: ENABLE_NETWORK_EXTENSION

By default, XenMobile enables the Apple Network Extension framework when Secure Hub installs. To disable Network Extension, go to **Settings > Client Properties**, add the custom key **ENABLE_NETWORK_EXTENSION**, and set the **Value** to **false**.

Default value: **true**

ENABLE_PASSCODE_AUTH

Display name: Enable Citrix PIN Authentication

This property allows you to turn on Citrix PIN functionality. With the Citrix PIN or passcode, users are prompted to define a PIN to use instead of their Active Directory password. This setting is automatically enabled when **ENABLE_PASSWORD_CACHING** is enabled or when XenMobile is using certificate authentication.

For offline authentication, the Citrix PIN is validated locally and users are allowed to access the app or content they requested. For online authentication, the Citrix PIN or passcode unlocks the Active Directory password or certificate, which is then sent to perform authentication with XenMobile.

Possible values: **true** or **false**

Default value: **false**

ENABLE_PASSWORD_CACHING

Display name: Enable User Password Caching

This property enables Active Directory passwords to cache locally on the mobile device. When you set this property to **true**, you must also set the **ENABLE_PASSCODE_AUTH** property to **true**. With user password caching enabled, XenMobile prompts users to set a Citrix PIN or passcode.

Possible values: **true** or **false**

Default value: **false**

ENABLE_TOUCH_ID_AUTH

Display name: Enable Touch ID Authentication

For devices that support Touch ID authentication, this property enables or disables Touch ID authentication on the

device. Requirements:

User devices must have Citrix PIN or LDAP enabled. If LDAP authentication is off (for example, because only certificate-based authentication is used), users must set a Citrix PIN. In this case, XenMobile requires the Citrix PIN even if the client property **ENABLE_PASSCODE_AUTH** is **false**.

Set **ENABLE_PASSCODE_AUTH** to **false** so that when users launch an app, they must respond to a prompt to use Touch ID.

Possible values: **true** or **false**

Default value: **false**

ENABLE_WORXHOME_CEIP

Display name: Enable Worx Home CEIP

This property turns on the Customer Experience Improvement Program. That feature sends anonymous configuration and usage data to Citrix periodically. The data helps Citrix improve the quality, reliability, and performance of XenMobile.

Value: **true** or **false**

Default value: **false**

ENABLE_WORXHOME_GA

Display name: Enable Google Analytics in Worx Home

This property enables or disables the ability to collect data using Google Analytics in Secure Hub. When you change this setting, the new value is set only when the user next logs on to Secure Hub (previously named Worx Home).

Possible values: **true** or **false**

Default value: **true**

ENCRYPT_SECRETS_USING_PASSCODE

Display name: Encrypt secrets using Passcode

This property stores sensitive data on the device in a secret vault instead of in a platform-based native store, such as the iOS keychain. This property enables strong encryption of key artifacts and adds user entropy. User entropy is a user-generated random PIN code that only the user knows.

Citrix recommends that you enable this property to help provide higher security on user devices. As a result, users experience more authentication prompts for the Citrix PIN.

Possible values: **true** or **false**

Default value: **false**

INACTIVITY_TIMER

Display name: Inactivity Timer

This property defines how long users can leave their device inactive and then access an app without a prompt for a Citrix PIN or passcode. To enable this setting for an MDX app, set the App Passcode setting to On. If the App Passcode setting is set to Off, users are redirected to Secure Hub to perform a full authentication. When you change this setting, the value takes effect the next time that users are prompted to authenticate.

Note: On iOS, the Inactivity Timer also governs access to Secure Hub for MDX and non-MDX apps.

Possible values: Any positive integer

Default value: **15** (minutes)

ON_FAILURE_USE_EMAIL

Display name: On failure Use Email to Send device logs to IT help desk

This property enables or disables the ability to use email to send device logs to IT.

Possible values: **true** or **false**

Default value: **true**

PASSCODE_EXPIRY

Display name: PIN Change Requirement

This property defines how long the Citrix PIN or passcode is valid, after which the user is forced to change their Citrix PIN or passcode. When you change this setting, the new value is set only when the current Citrix PIN or passcode expires.

Possible values: **1** through **99** recommended. To eliminate PIN resets, set the value to a very high number (for example, 100,000,000,000). If you originally set the expiry period to between 1 and 99 days and then change to the large number during that period: PINs still expire at the end of the initial period, but never again afterward.

Default value: **90** (days)

PASSCODE_HISTORY

Display name: PIN History

This property defines the number of previously used Citrix PINs or passcodes that users cannot reuse when changing their Citrix PIN or passcode. When you change this setting, the new value is set the next time that users reset their Citrix PIN or passcode.

Possible values: **1** through **99**

Default value: **5**

PASSCODE_MAX_ATTEMPTS

Display name: PIN Attempts

This property defines how many wrong Citrix PIN or passcode attempts users can make before being prompted for full authentication. After users successfully perform a full authentication, they are prompted to create a Citrix PIN or passcode.

Possible values: Any positive integer

Default value: **15**

PASSCODE_MIN_LENGTH

Display name: PIN Length Requirement

This property defines the minimum length of Citrix PINs.

Possible values: **1** through **99**

Default value: **6**

PASSCODE_STRENGTH

Display name: PIN Strength Requirement

This property defines the strength of Citrix PIN or passcode. When you change this setting, users are prompted to create a Citrix PIN or passcode the next time they are prompted to authenticate.

Possible values: **Low**, **Medium**, or **Strong**

Default value: **Medium**

The following table describes the password rules for each strength setting based on the PASSCODE_TYPE setting:

Passcode strength	Rules for numeric passcode type	Rules for alphanumeric passcode type
Low	All numbers, any sequence allowed	Must contain at least one number and one letter. Not allowed: AAAaaa, aaaaaa, abcdef Allowed: aa11b1, Abcd1#, Ab123~, aaaa11, aa11aa
Medium (default setting)	1. All numbers cannot be the same. For example, 444444 is not allowed. 2. All numbers cannot be consecutive. For example, 123456 or 654321 is not allowed. Allowed: 444333, 124567, 136790, 555556, 788888	In addition to the rules for Low passcode strength: 1. Letters and all numbers cannot be same. For example, aaaa11, aa11aa, or aaa111 are not allowed. 2. Letters cannot be consecutive and numbers cannot be consecutive. For example, abcd12, bcd123, 123abc, xy1234, xyz345, or cba123 are not allowed. Allowed: aa11b1, aaa11b, aaa1b2, abc145, xyz135, sdf123, ab12c3, a1b2c3, Abcd1#, Ab123~
High	Same as for the Medium Citrix PIN passcode strength.	Include at least one capital letter and one small letter. Not allowed: abcd12, DFGH2

		Allowed: Abcd12, jkrtA2, 23Bc#, AbCd
Strong	Same as for the Medium Citrix PIN passcode strength.	<p>Include at least one number, one special symbol, one capital letter, and one small letter.</p> <p>Not allowed: abcd12, Abcd12, dfgh12, jkrtA2</p> <p>Allowed: Abcd1#, Ab123~, xY12#3, Car12#, AAbc1#</p>

PASSCODE_TYPE

Display name: PIN Type

This property defines whether users are able to define a numerical Citrix PIN or an alphanumeric passcode. When you select **Numeric**, users can use numbers only (Citrix PIN). When you select **Alphanumeric**, users can use a combination of letters and numbers (passcode).

Note: If you change this setting, users must set a new Citrix PIN or passcode the next time that they are prompted to authenticate.

Possible values: **Numeric** or **Alphanumeric**

Default value: **Numeric**

REFRESHINTERVAL

Display name: REFRESHINTERVAL

By default, XenMobile pings the Auto Discovery Server (ADS) for pinned certificates every 3 days. To change the refresh interval, go to **Settings > Client Properties**, add the custom key **REFRESHINTERVAL**, and set the **Value** to the number of hours.

Default value: **72** hours (3 days)

SEND_LDAP_ATTRIBUTES

For MAM-only deployments of Android, iOS, or macOS devices: You can configure XenMobile so that users who enroll in Secure Hub with email credentials are automatically enrolled in Secure Mail. As a result, users don't provide extra information or take extra steps to enroll in Secure Mail.

To configure this global client policy, go to **Settings > Client Properties**, add the custom key **SEND_LDAP_ATTRIBUTES**, and set the **Value** as follows.

Value: userPrincipalName=\${user.userprincipalname},SAMAccountName=\${user.samaccountname}, displayName=\${user.displayName},mail=\${user.mail}

The attribute values are specified as macros, similar to MDM policies.

Here is a sample account service response for this property:

```
<property value="userPrincipalName=eng1@xmslab.com,sAMAccountName=eng1,displayName=eng1\,
test1,email=eng1@xmslab.com\",eng1@xmslab.com" name="SEND_LDAP_ATTRIBUTES"/>
```

Note: For this property, XenMobile treats comma characters as string terminators. Therefore, if an attribute value includes a comma, precede it with a backslash. The backslash prevents the client from interpreting the embedded comma as the end of the attribute value. Represent backslash characters with "\\".

TUNNEL_EXCLUDE_DOMAINS

Display name: Tunnel Exclude Domains

By default, MDX excludes from micro VPN tunneling some service endpoints that XenMobile SDKs and apps use for various features. For example, those endpoints include services that don't require routing through enterprise networks, such as Google Analytics, Citrix Cloud services, and Active Directory services. Use this client property to override the default list of domains excluded.

To configure this global client policy, go to **Settings > Client Properties**, add the custom key **TUNNEL_EXCLUDE_DOMAINS**, and set the **Value**.

Value: To replace the default list with the domains that you want to exclude from tunneling, type a comma-separated list of domain suffixes. To include all domains in tunneling, type **none**. Default is:

```
app.launchdarkly.com,cis.citrix.com,cis-staging.citrix.com,cis-test.citrix.com,clientstream,launchdarkly.com,
crashlytics.com,events.launchdarkly.com,fabric.io,firehose.launchdarkly.com, hockeyapp.net,mobile.launchdarkly.com,
pushreg.xml.citrix.com,rttf.citrix.com,rttf-staging.citrix.com,rttf-test.citrix.com,ssl.google-
analytics.com,stream.launchdarkly.com
```

Deploy iOS and macOS devices through Apple DEP

Jun 19, 2017

You must enroll in the Apple Deployment Program to use the Apple Device Enrollment Program (DEP) for iOS and macOS device enrollment and management in XenMobile. For information about signing up for an Apple Deployment Program account, see this [PDF](#) from Apple.

Be aware that the Apple Deployment Program is available for organizations and not individuals. You must provide a considerable amount of corporate details and information to create an Apple Deployment Program account. Thus, it could take time to request and receive approval for accounts.

Enroll in the Apple Deployment Program

1. Go to deploy.apple.com to apply for an Apple Deployment Program account. When applying for a DEP account, the best practice is to use an email address for the organization, such as `dep@company.com`.

Note: For education accounts, go to <https://school.apple.com/>.

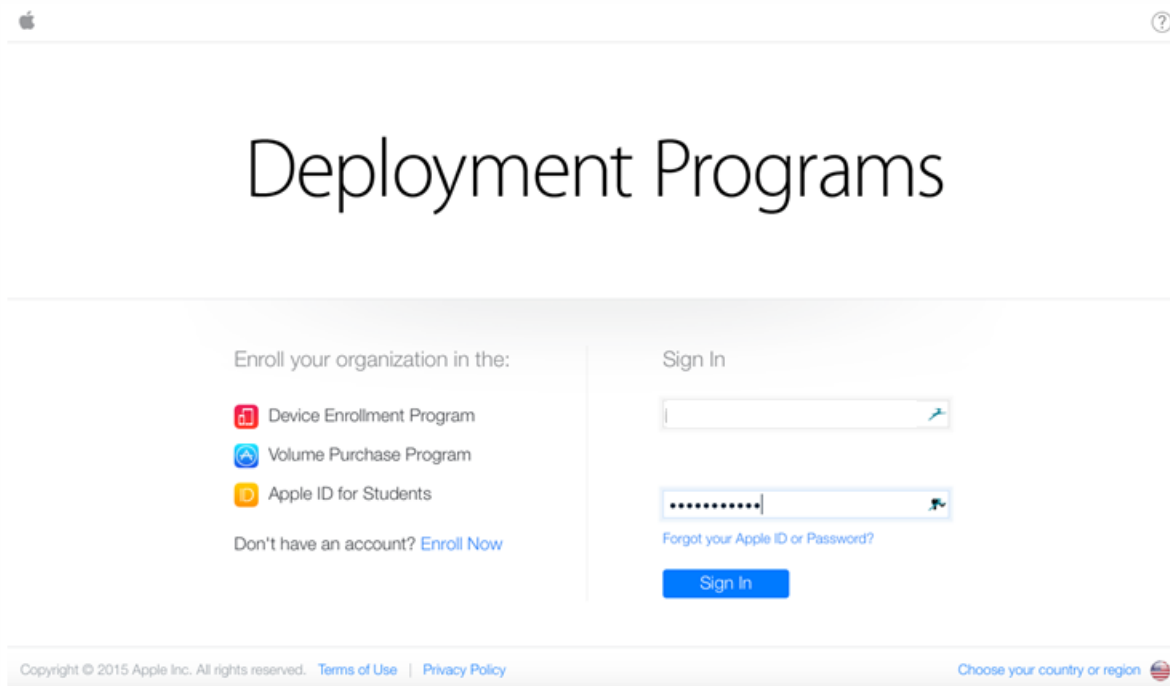

The screenshot shows the Apple Deployment Programs website. At the top left is the Apple logo, and at the top right is a help icon. The main heading is "Deployment Programs". Below this, there are two columns. The left column is titled "Enroll your organization in the:" and lists three options: "Device Enrollment Program" (with a red icon), "Volume Purchase Program" (with a blue icon), and "Apple ID for Students" (with a yellow icon). Below these options is a link: "Don't have an account? [Enroll Now](#)". The right column is titled "Sign In" and contains a text input field for an email address, a password input field with a strength indicator, a link for "Forgot your Apple ID or Password?", and a blue "Sign In" button. At the bottom of the page, there is a footer with copyright information: "Copyright © 2015 Apple Inc. All rights reserved." and links for "Terms of Use" and "Privacy Policy". On the far right of the footer is a link: "Choose your country or region" with a globe icon.

2. After you type your organization information, Apple emails you a temporary password for the new Apple ID.

- 1 Your Details
- 2 Verification Contact
- 3 Institution Details
- 4 Review

Check Your E-mail

An e-mail has been sent to [redacted] with your Apple ID and temporary password, and the next steps to continue your enrollment.

1. Complete your Apple ID setup.

[Visit My Apple ID >](#)

Using the Apple ID and temporary password included in the e-mail, sign in and complete your account setup at My Apple ID.

2. Enable two-step verification for this account as it is required by some programs.

3. Continue your Deployment Programs enrollment.

After completing the steps above, please return and continue this enrollment here at deploy.apple.com.

Resend E-mail

3. You then sign in with your Apple ID and complete the security settings for the account.

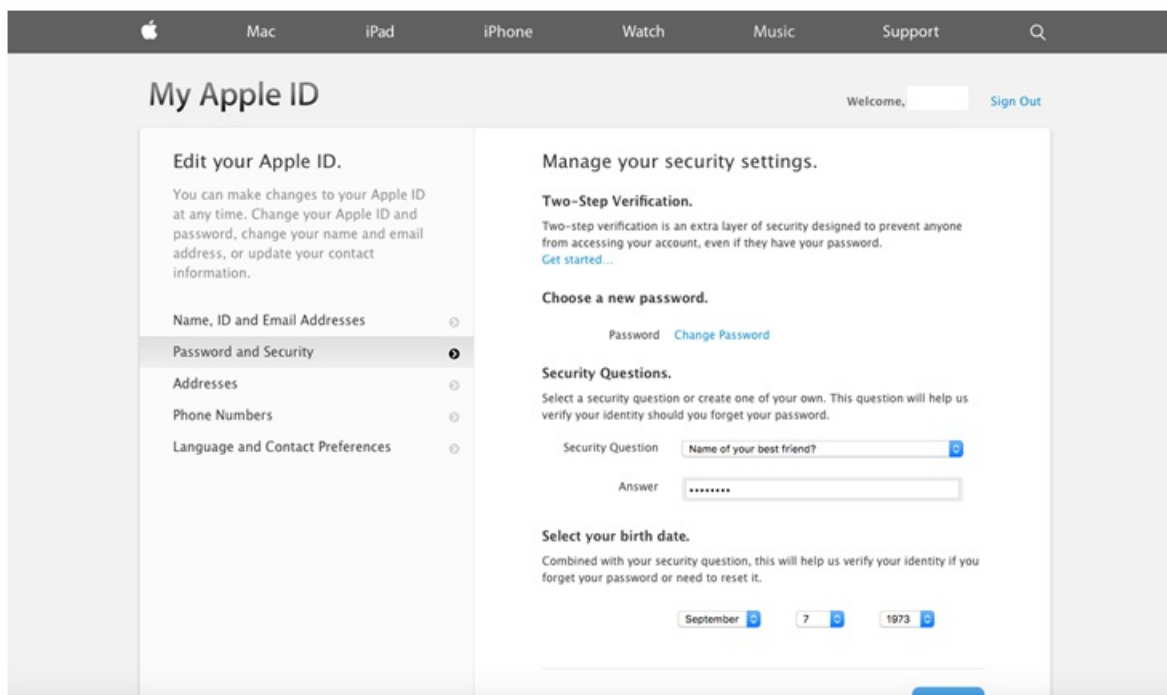

4. Configure and enable two-step verification, which is required for use with the DEP Portal. During these steps, after you add a phone number, you receive the 4-digit PIN for the two-step verification.

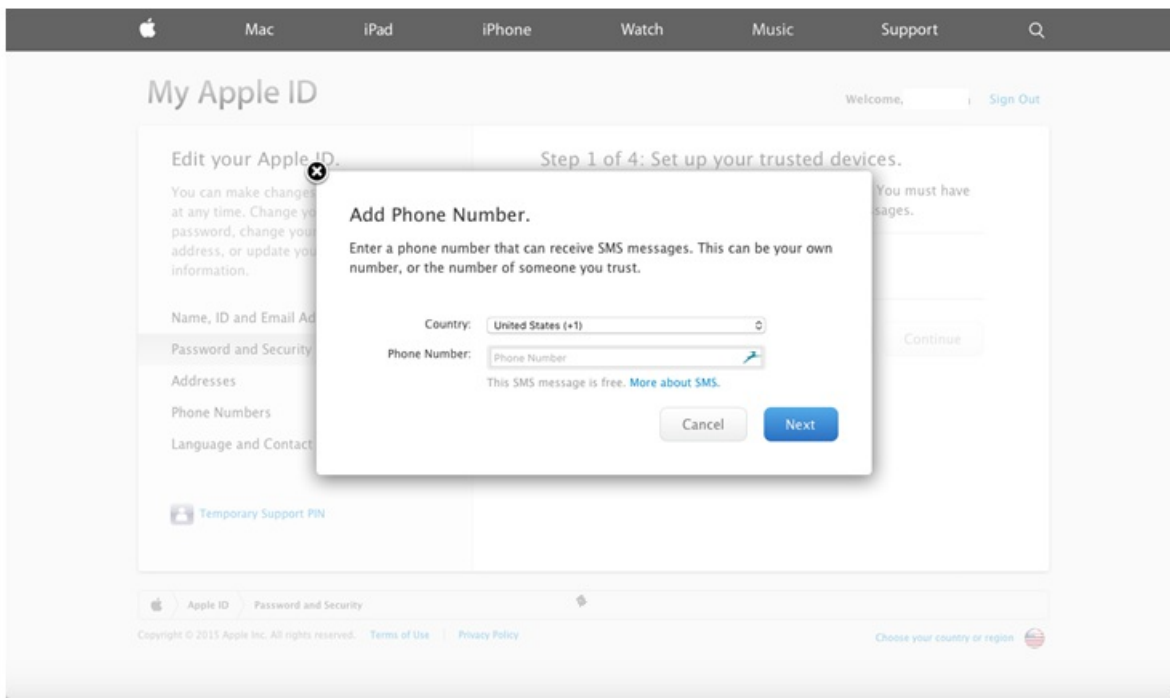

5. Log in to the DEP Portal to complete the account configuration using the two-step verification that you set up.

6. Add your company details and then select from where you purchase devices. For details on purchasing options, see the next section, [Ordering DEP-enabled devices](#).

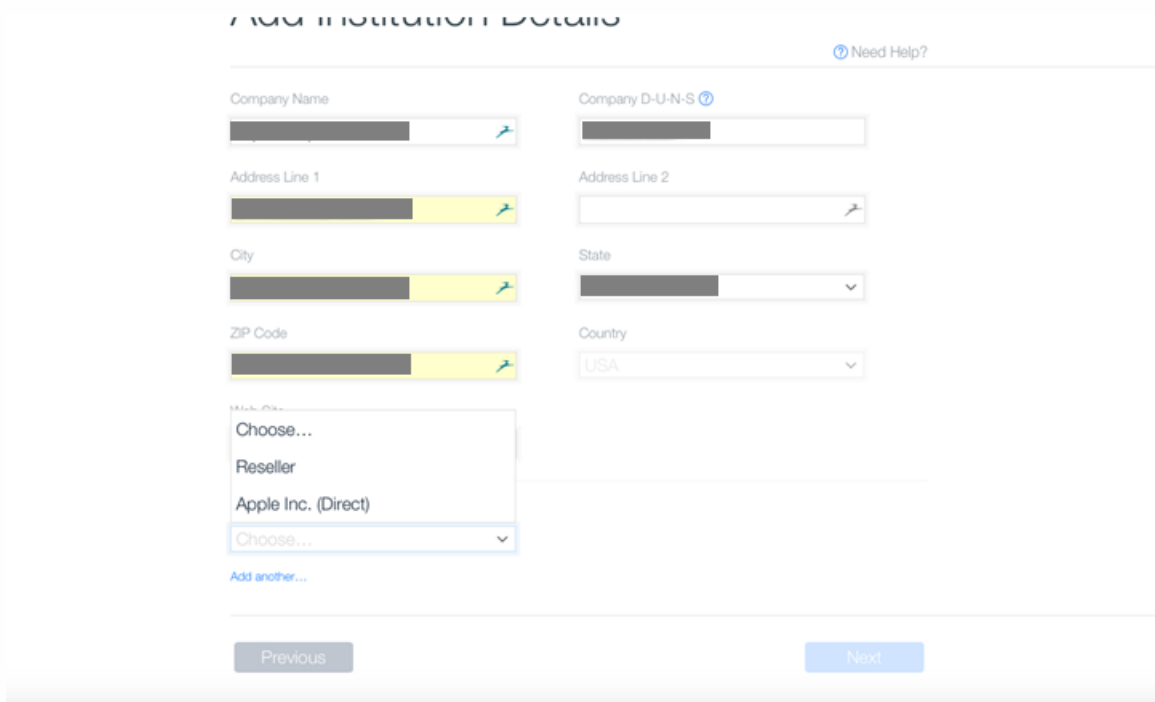

7. Add the Apple Customer Number or the DEP Reseller ID. Then verify your enrollment details and wait for Apple to approve your account.

7 ADD INSTITUTION DETAILS

[Need Help?](#)

Company Name [Redacted]	Company D-U-N-S ? [Redacted]
Address Line 1 [Redacted]	Address Line 2 [Redacted]
City [Redacted]	State [Redacted]
ZIP Code [Redacted]	Country USA
Web Site [Redacted]	
Devices Purchased From Reseller	DEP Reseller ID ? [Redacted] CDW

[Add another...](#)

Previous

Next

Deployment Programs

1 Your Details 2 Verification Contact 3 Institution Details 4 Review

Review Your Enrollment Details

[Need Help?](#)

Your Details	Verification Contact	Institution Details
Your Name [Redacted]	Verification Contact Name [Redacted]	Company Name [Redacted]
Your Work E-mail [Redacted]	Verification Contact Work E-mail [Redacted]	Web Site [Redacted]
Your Work Phone [Redacted]	Verification Contact Work Phone [Redacted]	Address [Redacted]
Your Title / Position General Manager	Title / Position General Manager	Devices Purchased From [Redacted]

Edit Submit

8. After you receive your logon credentials from Apple, log in to the Apple DEP Portal.

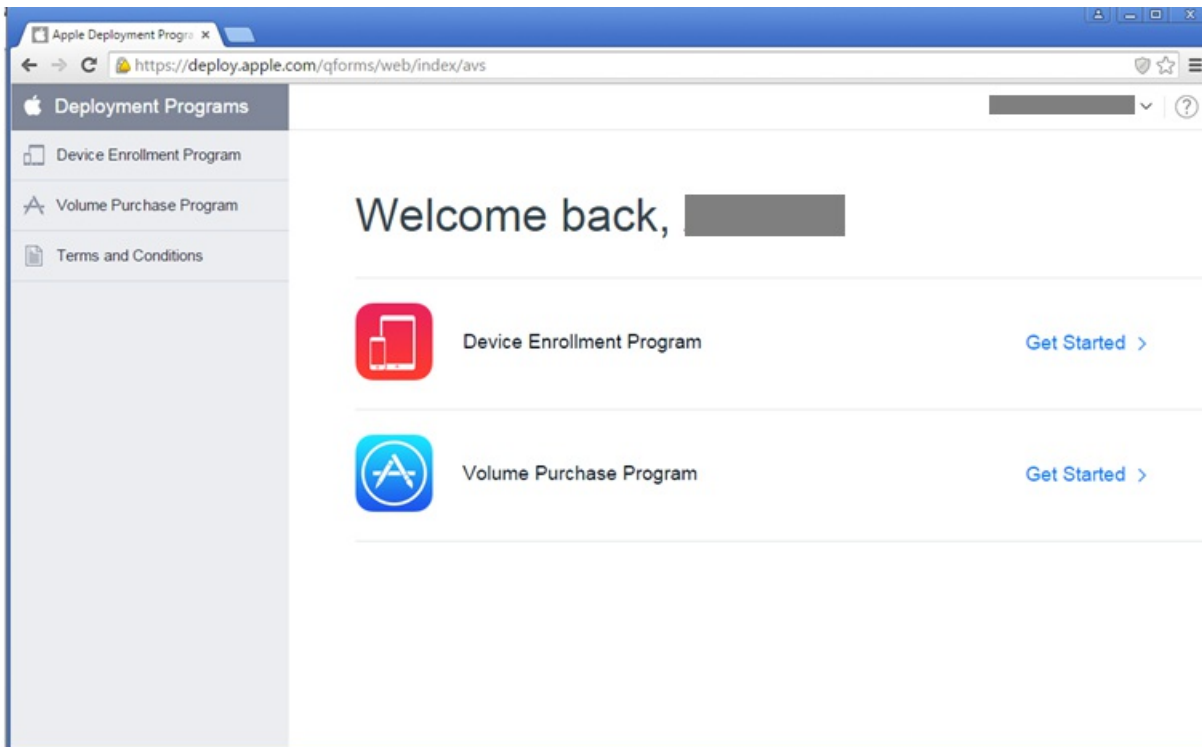

To connect your account to XenMobile, see "Integrate your Apple DEP account with XenMobile" in [Bulk enrollment of iOS and macOS devices](#).

Order DEP-enabled devices

You can order DEP-enabled devices directly from Apple or DEP-enabled authorized resellers or carriers. To order from Apple, provide your Apple Customer ID in the Apple DEP Portal. Your Customer ID enables Apple to associate your purchased devices with your Apple DEP account.

To order from your reseller or carrier, contact your Apple reseller or carrier to check if they participate in the Apple DEP. Ask for the Apple DEP ID of the reseller when purchasing devices. Apple requires that information when you add your Apple DEP reseller to your Apple DEP account. After you add the Apple DEP ID for the reseller, you receive a DEP customer ID. Provide the DEP customer ID to the reseller, who uses the ID to submit information about your device purchases to Apple. For more information, see this [Apple website](#).

Manage DEP-enabled devices

Follow these steps to associate devices with your XenMobile Server by using the DEP Portal to update your Apple DEP account.

1. Log on to the Apple DEP Portal.
2. Click **Device Enrollment Program** and then click **Manage Devices**. In **Choose Devices By**, choose the option for which you want to upload and define your Apple DEP-enabled devices: **Serial Number**, **Order Number**, or **Upload CSV File**.

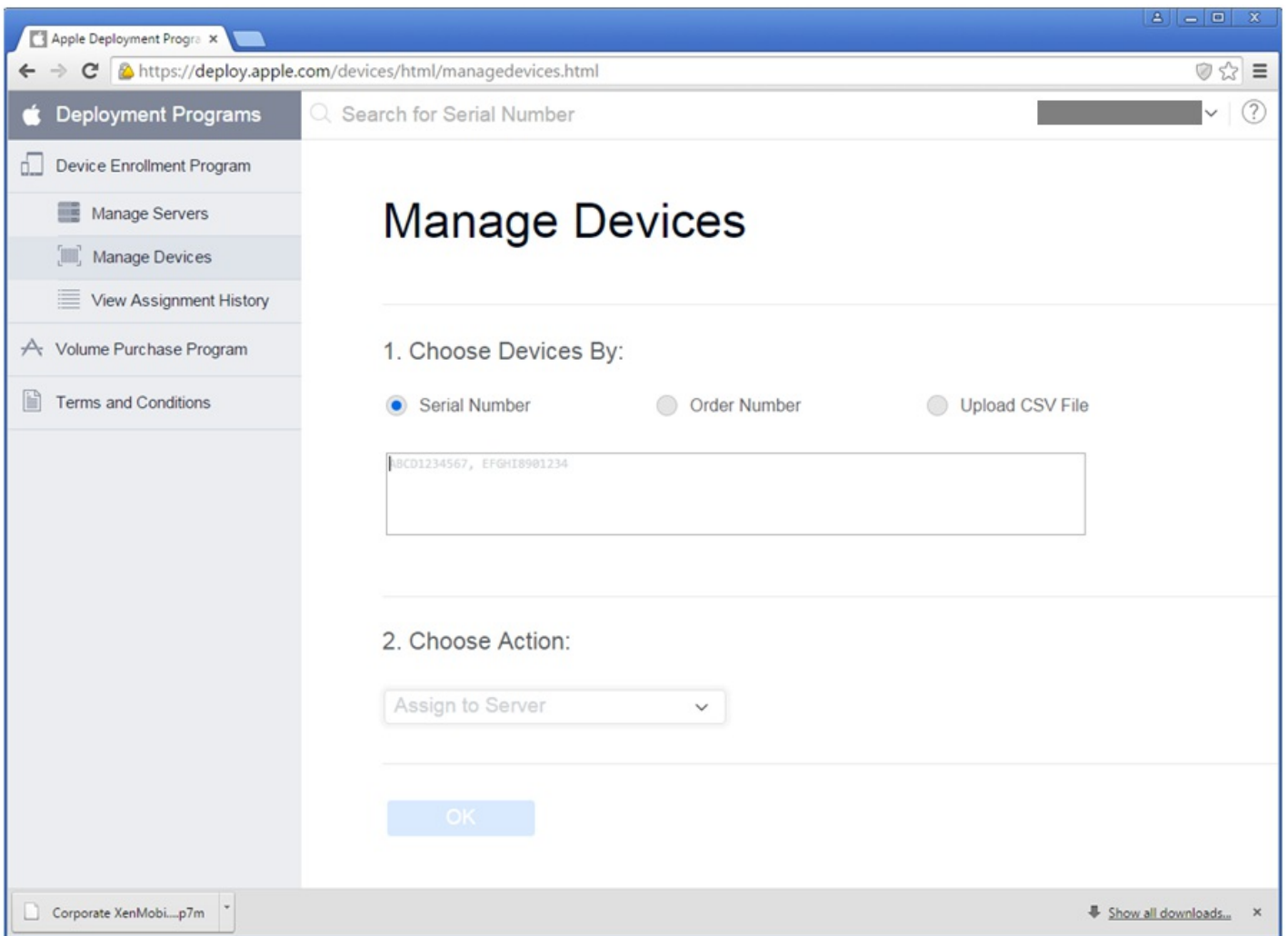

3. To assign your devices to a XenMobile Server, under **Choose Action**, choose **Assign to Server**. Then, in the list, choose the name of your XenMobile Server. Click **OK**.

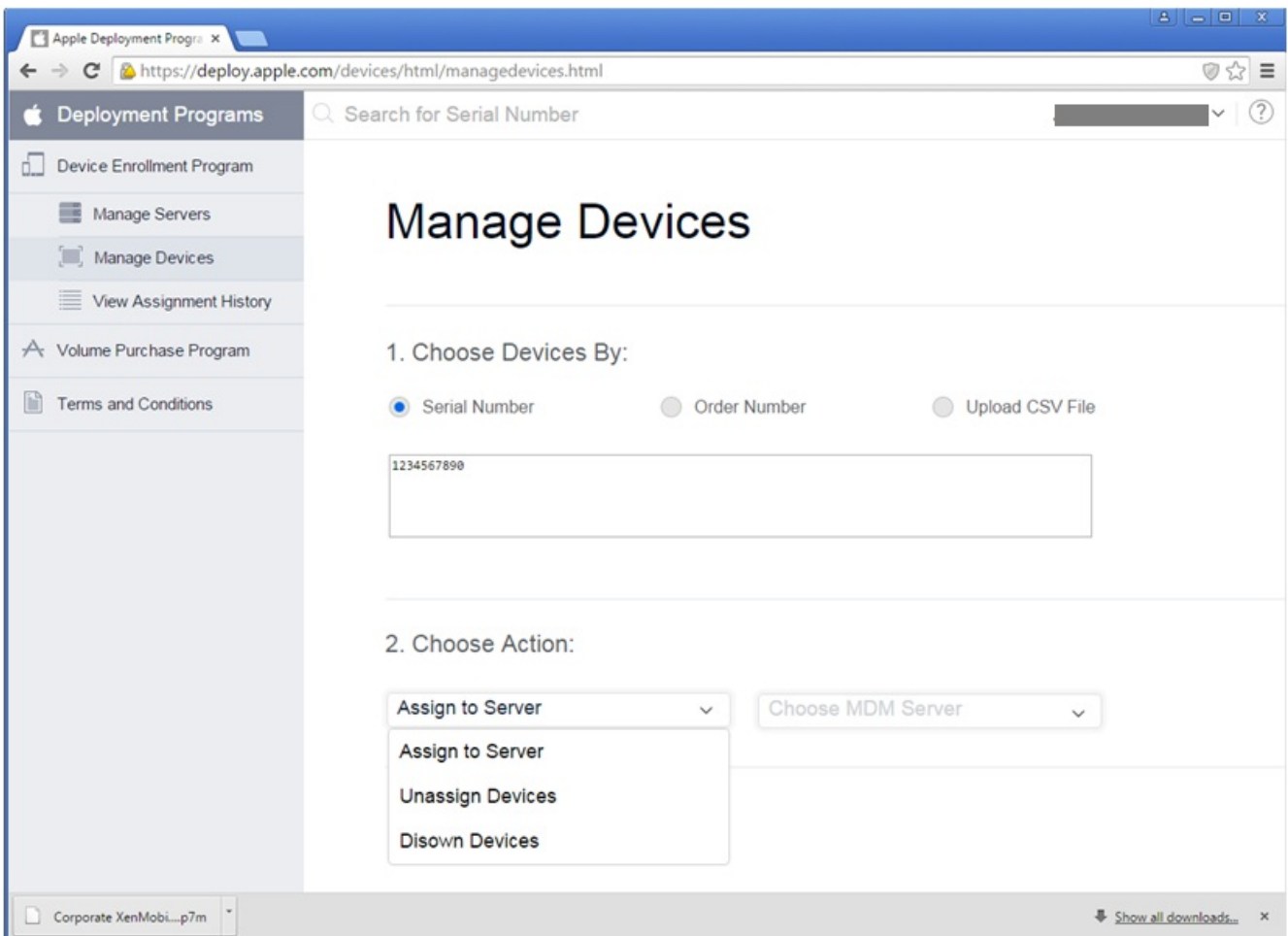

Your Apple DEP devices are now associated with the selected XenMobile Server.

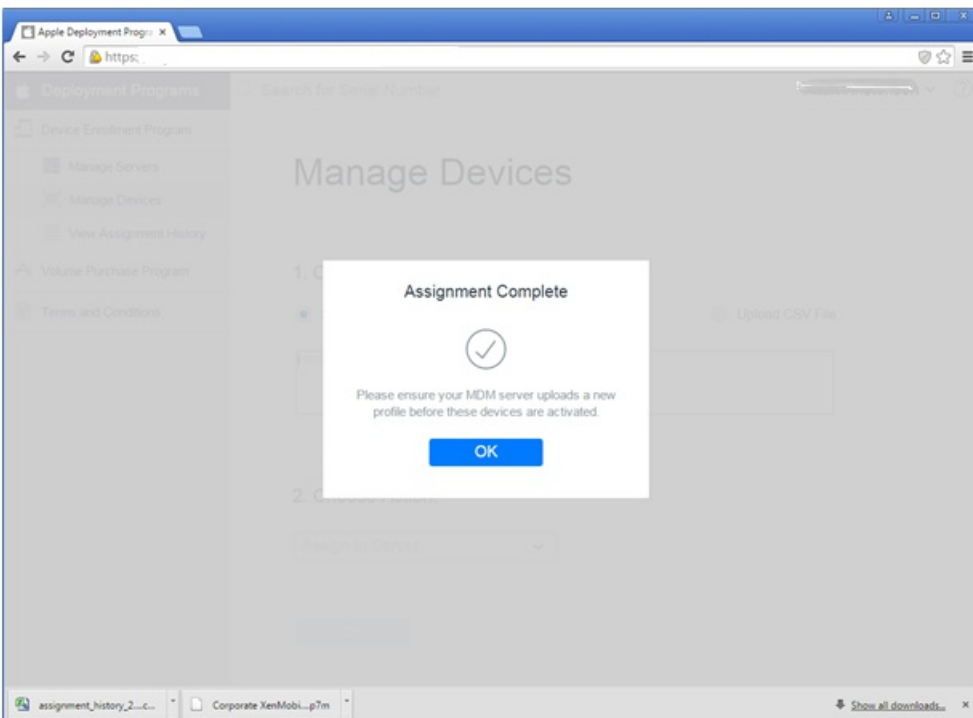

User experience when enrolling an Apple DEP-enabled device

When users enroll an Apple DEP-enabled device, their experience is as follows.

1. Users start their Apple DEP-enabled device.
2. XenMobile delivers the Apple DEP configuration that you configured in the XenMobile console to the Apple DEP-enabled device.
3. Users configure the initial settings on their device.
4. The device automatically starts the XenMobile device enrollment process.
5. Users continue to configure the other initial settings on their device.
6. In the home screen, users might be prompted to sign in to iTunes so that they can download Citrix Secure Hub.

Note

This step is optional if XenMobile is configured to deploy the Secure Hub app using the device-based Volume Purchase Program (VPP) app assignment. In this case, you don't need to create an iTunes account or use an existing account.

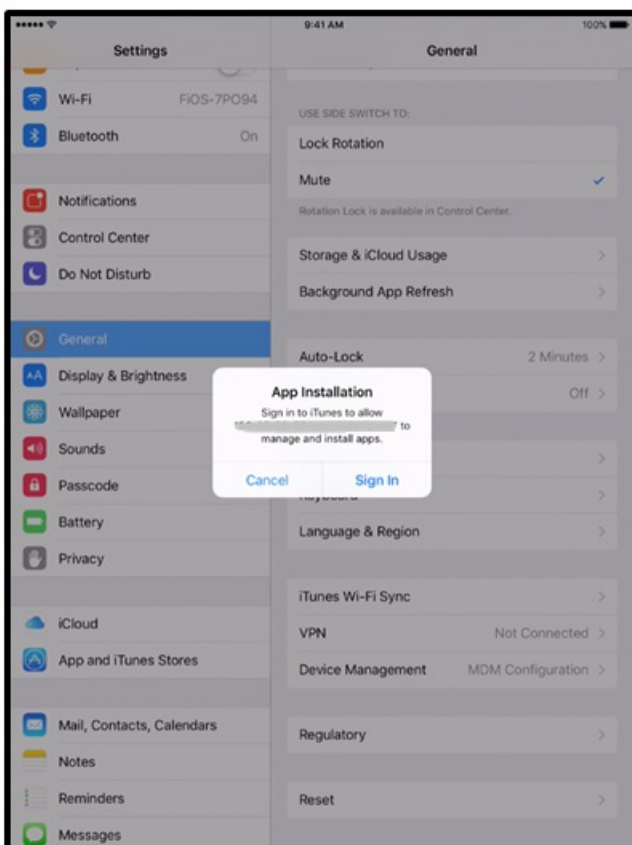

7. Users open Secure Hub and type their credentials. If required by the policy, users might be prompted to create and verify a Citrix PIN.

XenMobile deploys any remaining required apps to the device.

Device enrollment limit

Jun 19, 2017

You can limit the number of devices that a user can enroll under **Configure > Enrollment Profiles** in the XenMobile console, in ENT, MDM, and MAM server modes. Limitations can apply globally or per delivery group. You can create multiple enrollment profiles and associate them with different delivery groups.

If you do not set a limit, users can enroll an unlimited number of devices. This feature is supported only on iOS and Android devices.

To configure a global device enrollment limit

1. Go to **Configure > Enrollment Profiles**.
2. Click **Global** and select **Edit**.

The screenshot shows the XenMobile console interface. The top navigation bar includes 'XenMobile', 'Analyze', 'Manage', and 'Configure'. Below this, there are tabs for 'Device Policies', 'Apps', 'Actions', 'ShareFile', 'Enrollment Profiles', and 'Delivery Groups'. The 'Enrollment Profiles' tab is active. A search bar is located in the top right corner. Below the search bar, there is an 'Add' button. The main content area displays a table of enrollment profiles:

<input type="checkbox"/>	Enrollment profile name	Created on	Updated on	Device limit
<input type="checkbox"/>	ep1	2/11/16 1:44 PM	2/11/16 1:44 PM	3
<input type="checkbox"/>	Global	2/8/16 11:21 AM	2/8/16 11:21 AM	unlimited

Below the table, it says 'Showing 1 - 2 of 2 items'. A context menu is open over the 'Global' profile, showing 'Edit' and 'Reset' options.

The **Enrollment Info** screen appears with **Global** automatically filled in as the profile name. From here, you can select the total number of devices users are allowed to enroll. This limitation applies to all XenMobile enrollees.

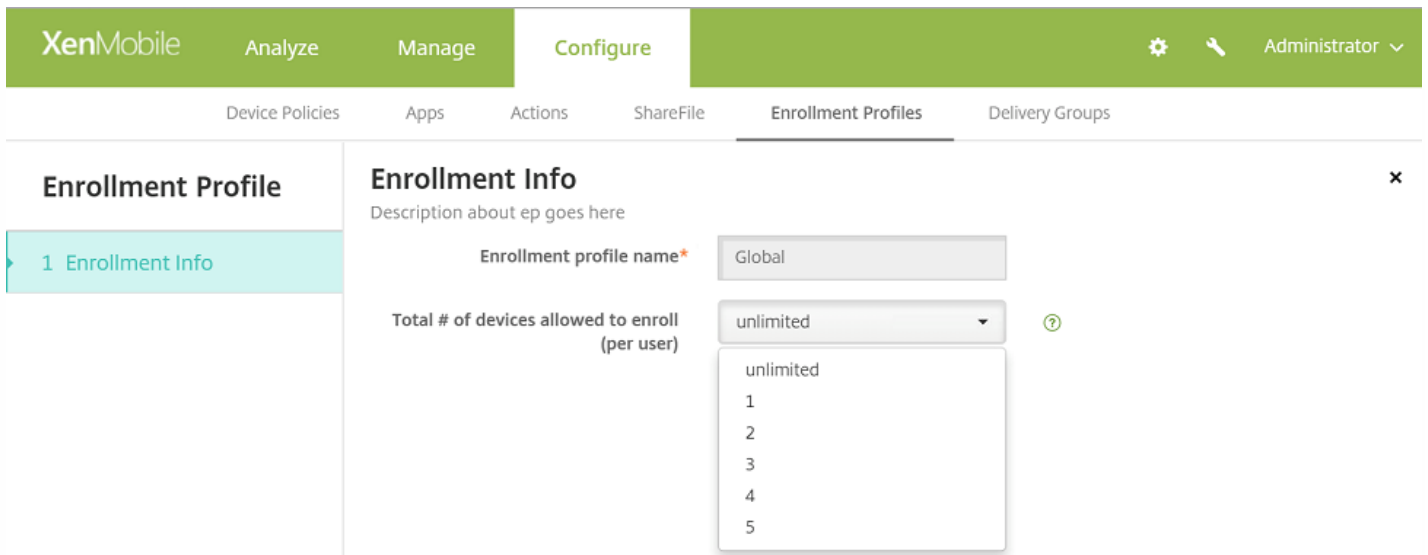

To configure a delivery group device enrollment limit

1. Go to **Configure > Enrollment Profiles > Add**.

The **Enrollment Info** screen appears.

2. Enter a name for the new enrollment profile and then select the number of devices that members with this profile are allowed to enroll.

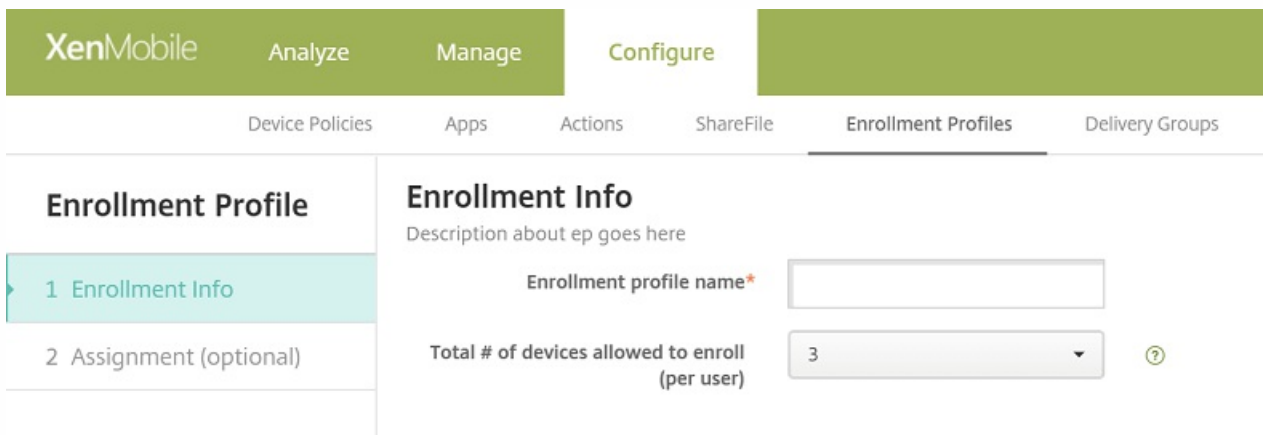

3. Click **Next**.

The **Delivery Group Assignment** screen appears.

4. Select the delivery groups to which the device enrollment limit will apply and then click **Save**.

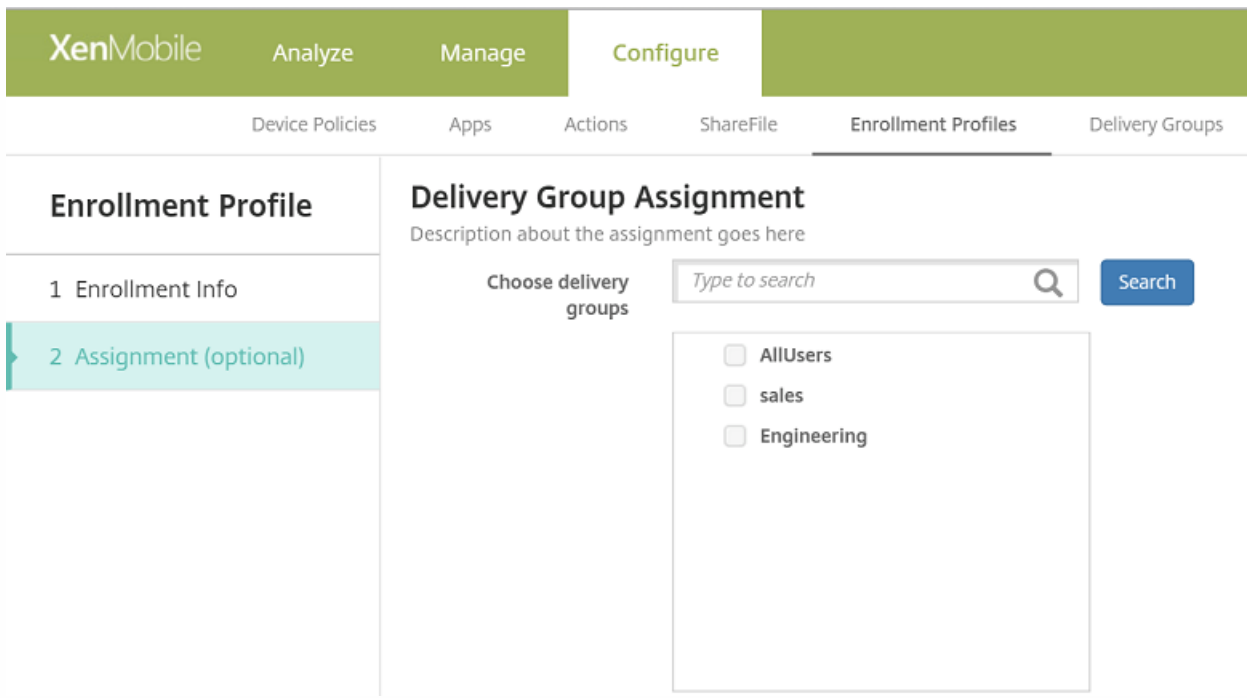

If later you want to change the enrollment profile for a delivery group, go to **Configure > Delivery Groups**. Select the group you want and then click **Edit**.

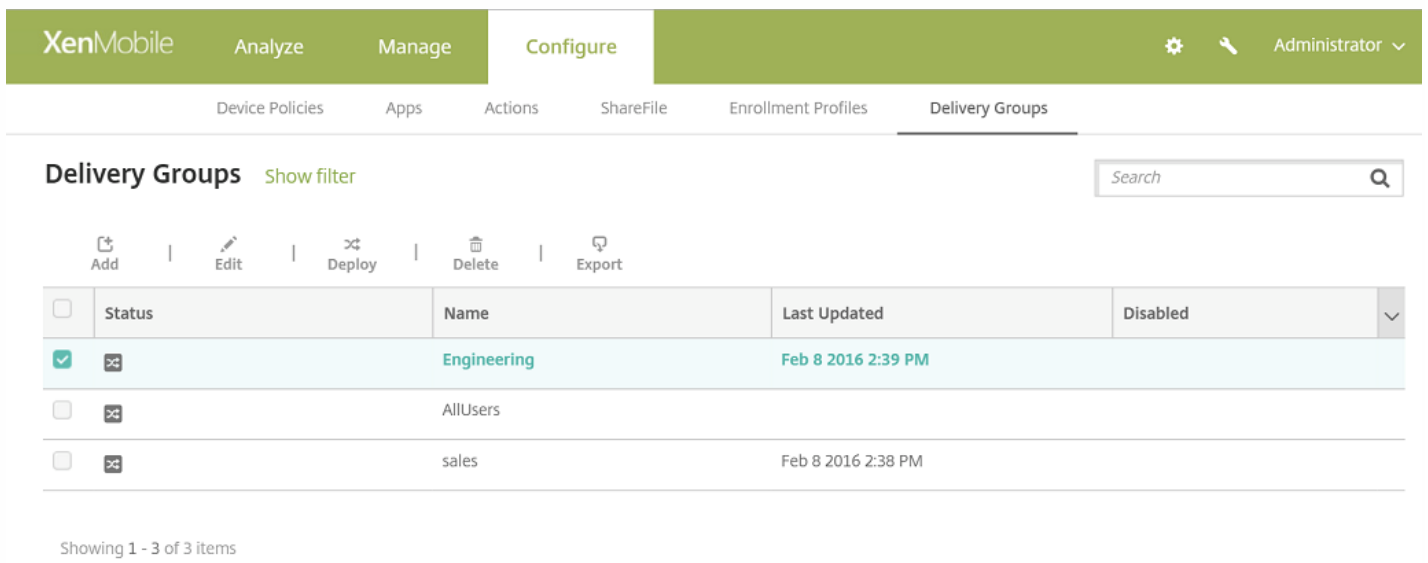

The **Enrollment Profile** screen appears.

5. From this screen, select the enrollment profile that you want to apply to this delivery group and then click **Next** to view and save your changes.

The screenshot shows the XenMobile configuration interface. The top navigation bar includes 'XenMobile', 'Analyze', 'Manage', and 'Configure'. The 'Configure' section is active, with sub-tabs for 'Device Policies', 'Apps', 'Actions', 'ShareFile', 'Enrollment Profiles', and 'Delivery Groups'. The 'Delivery Groups' tab is selected, and the 'Enrollment Profile' sub-tab is active. On the left, a sidebar lists the steps: 1 Delivery Group Info, 2 User, 3 Resource (optional), Policies, Apps, Actions, ShareFile, Enrollment Profile (highlighted), and 4 Summary. The main content area is titled 'Enrollment Profile' and contains the instruction: 'Select the enrollment profile that you want the users in this delivery group to see'. Below this, there are three radio button options: 'ep1', 'ep2', and 'Global' (which is selected). At the bottom right, there are 'Back' and 'Next >' buttons.

User experience with a device enrollment limit

When you set the device enrollment limit and users try to enroll a new device, they follow these steps:

1. Sign on to Secure Hub.
2. Enter a server address to enroll.
3. Enter credentials.
4. If the device limit is reached, an error message appears that tells the user that the device registration is exceeded and that they should contact an administrator.

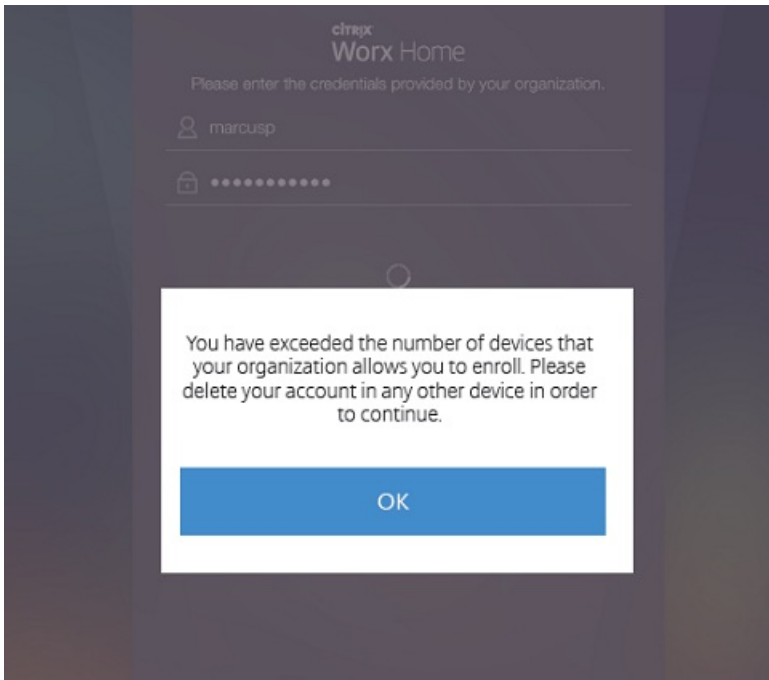

The Secure Hub enrollment screen appears again.

Enroll devices

Jun 19, 2017

To manage user devices remotely and securely, you enroll user devices in XenMobile. The XenMobile client software is installed on the user device and the user identity is authenticated. Then, XenMobile and the user profile are installed. Next, in the XenMobile console, you can perform device management tasks. You can apply policies, deploy apps, push data to the device, and lock, wipe, and locate lost or stolen devices.

Azure Active Directory enrollment is supported for iOS, Android, and Windows 10 devices. For more information about configuring Azure as your identity provider (IDP), see [XenMobile Integration with Azure Active Directory as IDP](#).

Note: Before you can enroll iOS device users, you must request an APNs certificate. For details, see [Certificates and authentication](#).

To update configuration options for users and devices, go to the **Manage > Enrollment Invitations** page. For details, see [Send an enrollment invitation](#) in this article.

This article has the following sections:

[Android devices](#)

[iOS devices that use user-provided credentials](#)

[iOS devices that use derived credentials](#)

[macOS devices](#)

[Windows devices](#)

[Send an enrollment invitation](#)

Android devices

1. Go to the Google Play store on your Android device, download the Citrix Secure Hub app, and then tap the app.
2. When prompted to install the app, click **Next** and then click **Install**.
3. After Secure Hub installs, tap **Open**.
4. Enter your corporate credentials, such as your XenMobile Server name, User Principal Name (UPN), or email address. Then, click **Next**.
5. In the **Activate device administrator** screen, tap **Activate**.
6. Enter your corporate password and then tap **Sign On**.
7. Depending on the way XenMobile is configured, you may be asked to create a Citrix PIN. You can use the PIN to sign on to Secure Hub and other XenMobile-enabled apps, such as Secure Mail and ShareFile. You enter your Citrix PIN twice. On the **Create Citrix PIN** screen, enter a PIN.
8. Reenter the PIN. Secure Hub opens. You can then access the XenMobile Store to view the apps you can install on your Android device.
9. If you configured XenMobile to push apps to devices automatically after enrollment, users are prompted to install the apps. In addition, policies that you configure in XenMobile are deployed to the device. Tap **Install** to install the apps.

To unenroll and reenroll an Android device

Users can unenroll from within Secure Hub. When users unenroll by using the following procedure, the device still appears in the device inventory in the XenMobile console. You cannot perform actions on the device, however. You cannot track the device, and you cannot monitor the device compliance.

1. Tap to open the Secure Hub app.
 2. Depending on whether you have a phone or a tablet, do the following:
On a phone:
 - a. Swipe from the left of the screen to open a settings pane.
 - b. Tap **Preferences**, tap **Accounts**, and then tap **Delete Account**.On a tablet:
 - a. Tap the arrow next to your email address on the upper-right corner.
 - b. Tap **Preferences**, tap **Accounts**, and then tap **Delete Account**.
 3. Tap **Re-Enroll**. A message appears to confirm you want to reenroll your device.
 4. Tap **OK**.
- Your device is unenrolled.
5. Follow the on-screen instructions to reenroll your device.

iOS devices that use user-provided credentials

1. Download the Secure Hub app from the Apple iTunes App Store on the device and then install the app on the device.
2. On the iOS device Home screen, tap the Secure Hub app.
3. When the Secure Hub app opens, enter the server address that your help desk provided.

The screens presented might differ from these examples, depending on how XenMobile is configured.

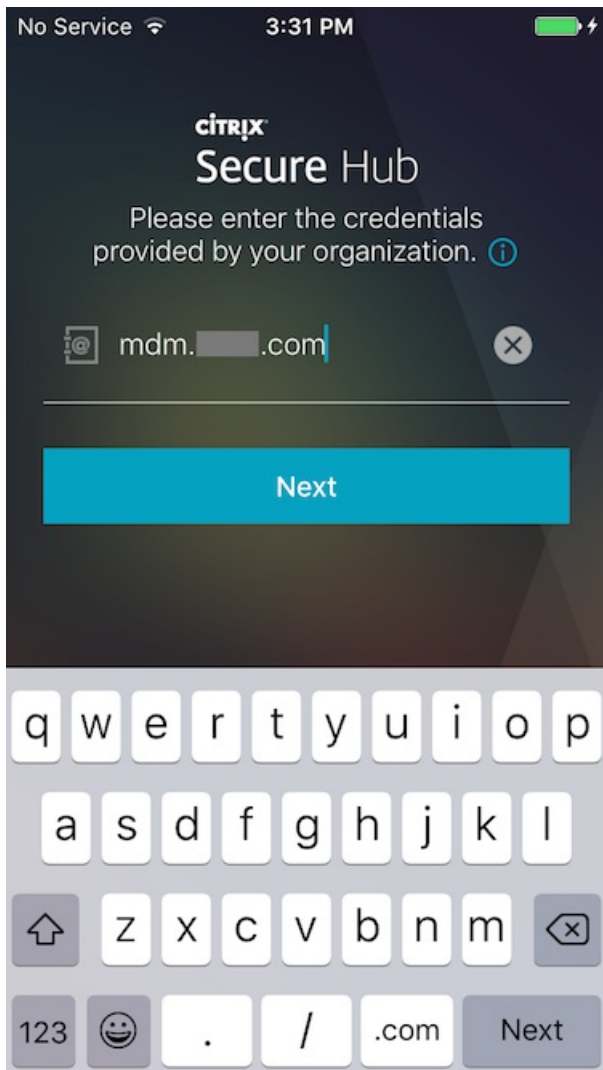

4. When prompted, enter your user name and password or PIN. Click **Next**.

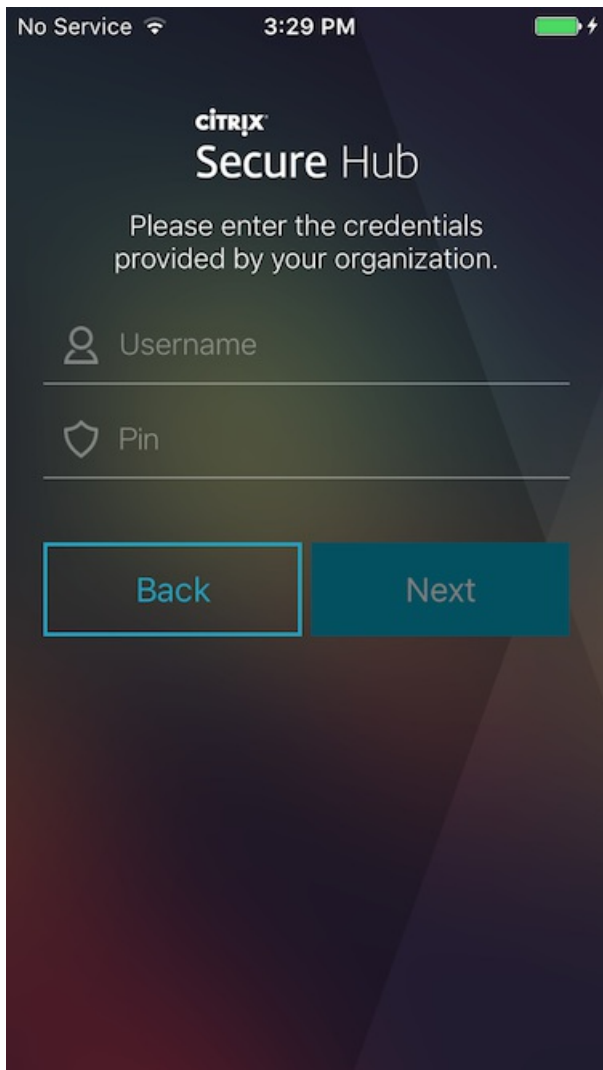

5. When prompted to enroll, click **Yes, Enroll** and then enter your credentials when prompted.

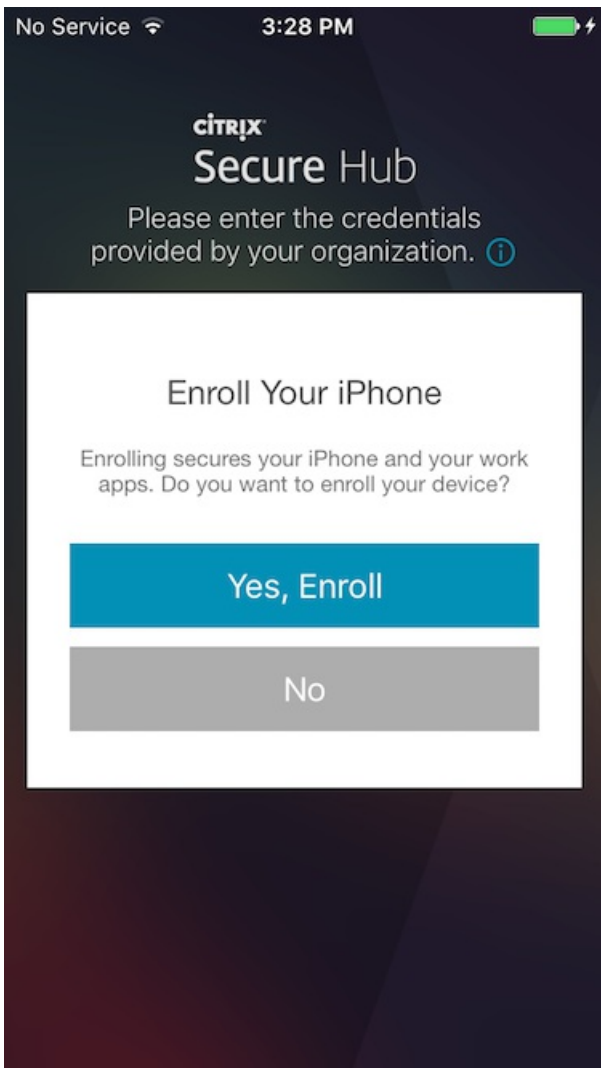

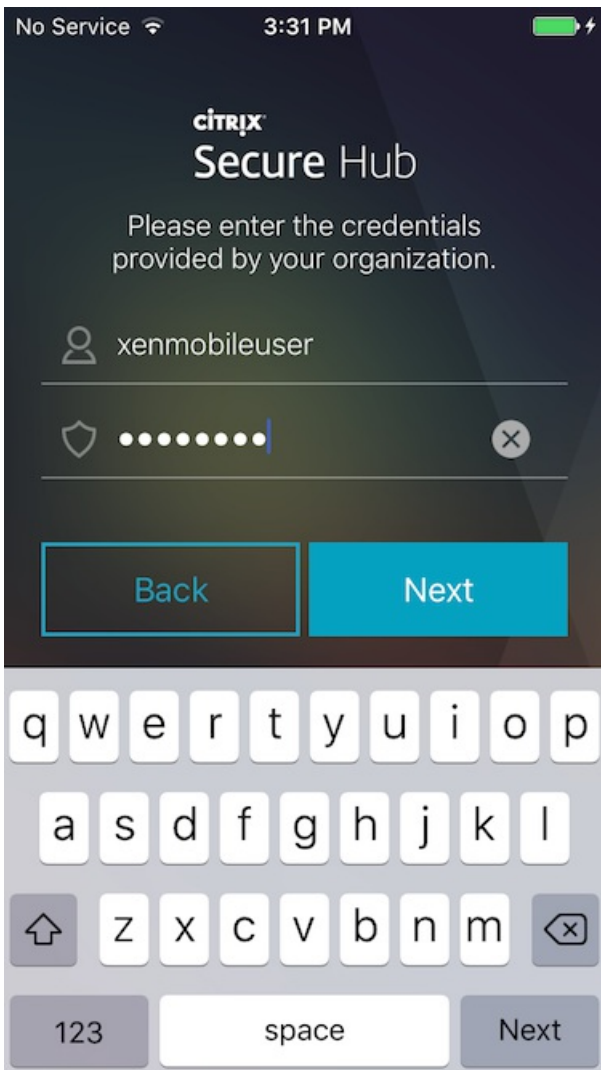

6. Tap **Install** to install the Citrix Profile Services.

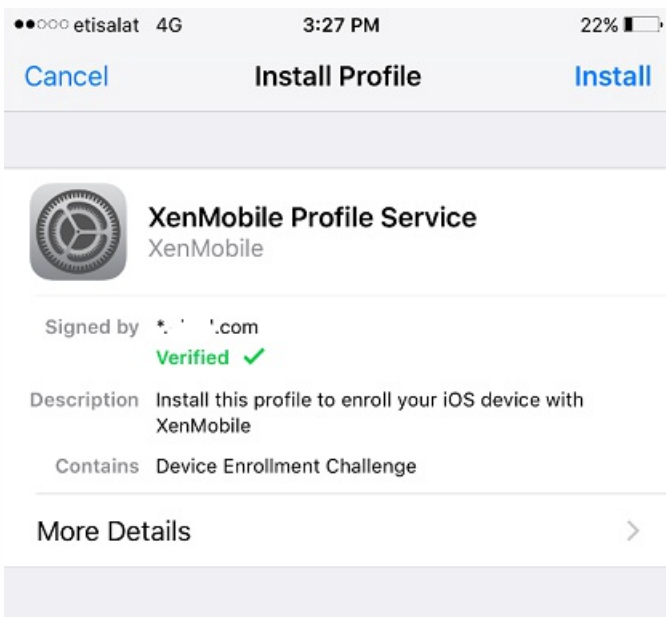

7. Tap **Trust**.

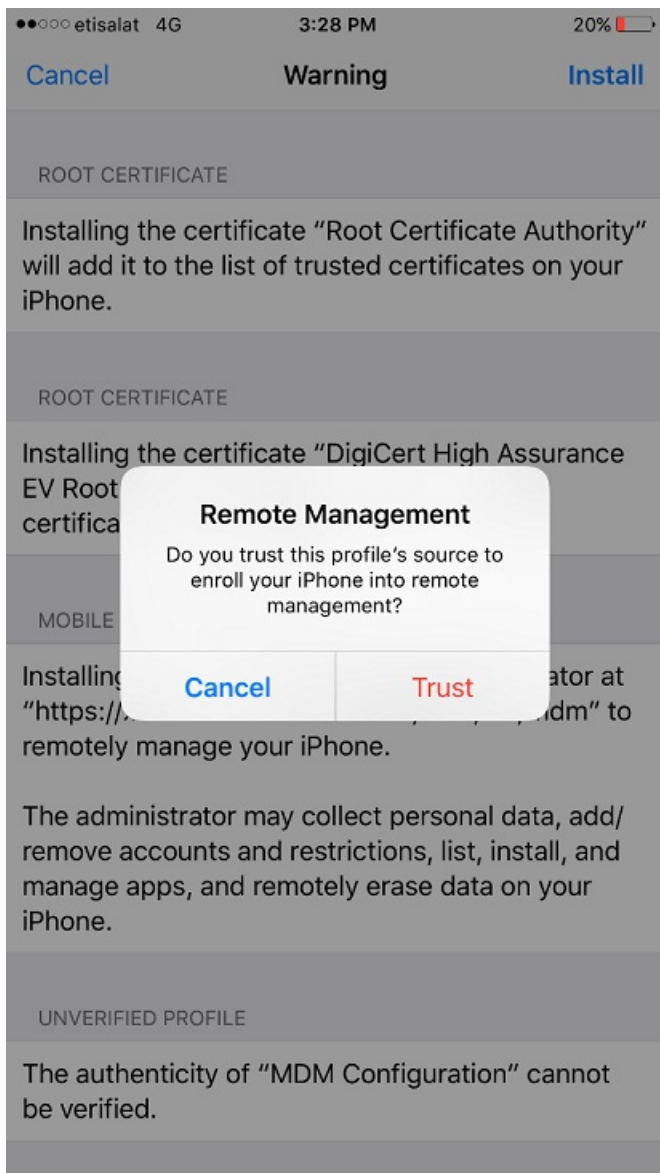

8. Tap **Open** and then enter your credentials.

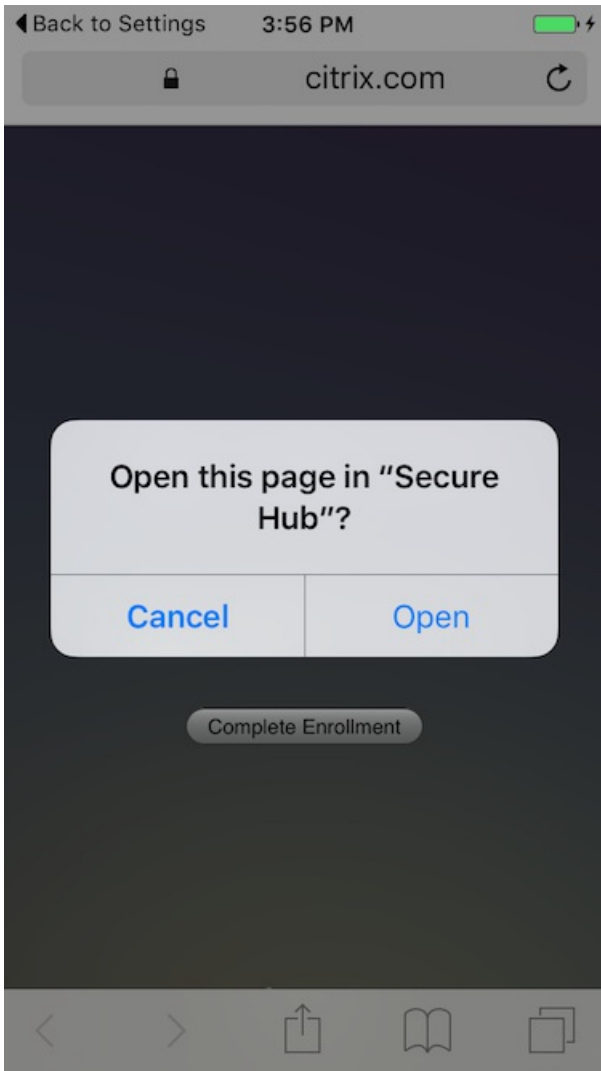

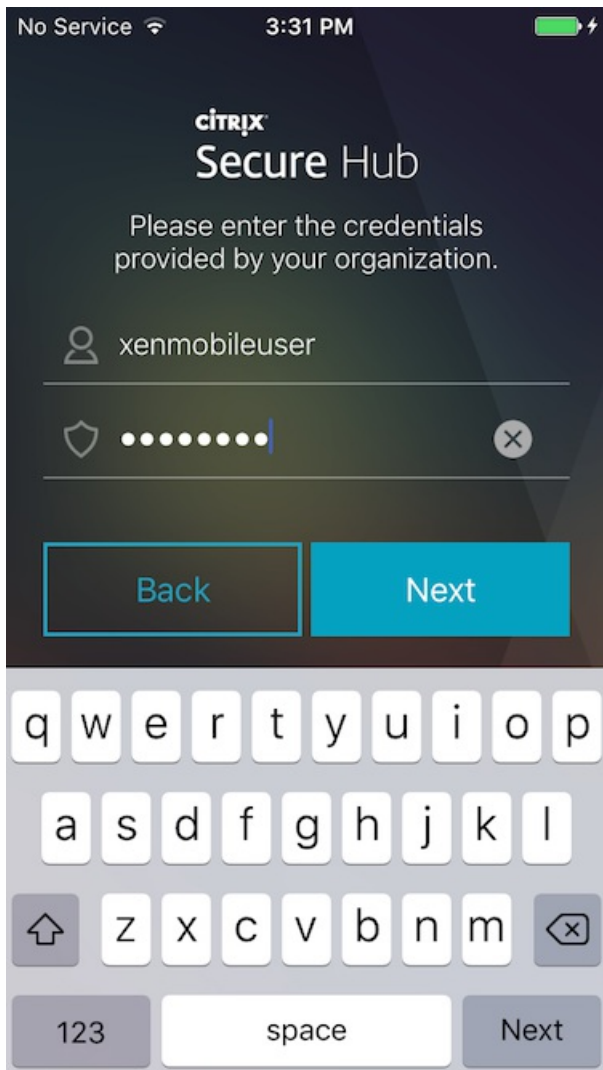

iOS devices that use derived credentials

Enrollment requires that users insert their smart card to a reader attached to their desktop.

1. The user installs Secure Hub and the app from your derived credential provider.

The identity provider app for Intercede is MyiD for Citrix. The logo for that app follows.



2. The user starts Secure Hub. When prompted, the user types the XenMobile Server fully qualified domain name and then clicks **Next**. Enrollment in Secure Hub starts. If the XenMobile Server supports derived credentials, Secure Hub prompts the user to create a Citrix PIN.

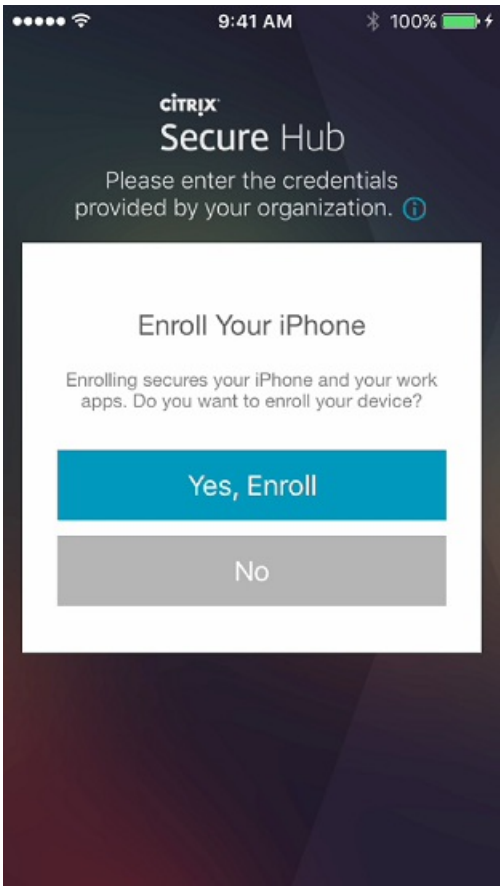
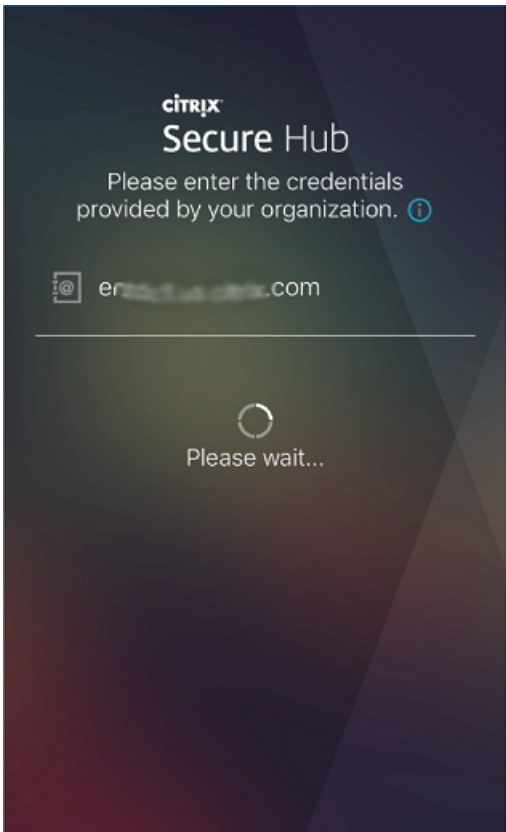

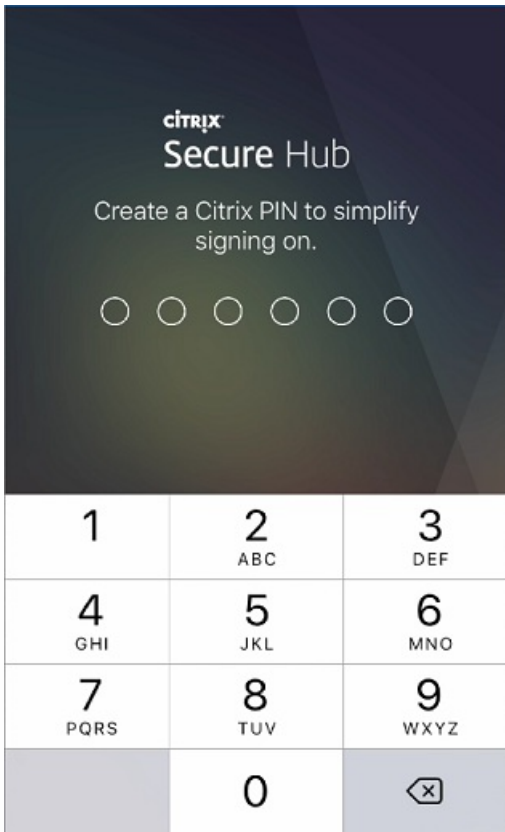

3. The user follows the instructions to activate their smart credential. A splash screen appears, followed by a prompt to scan a QR code.

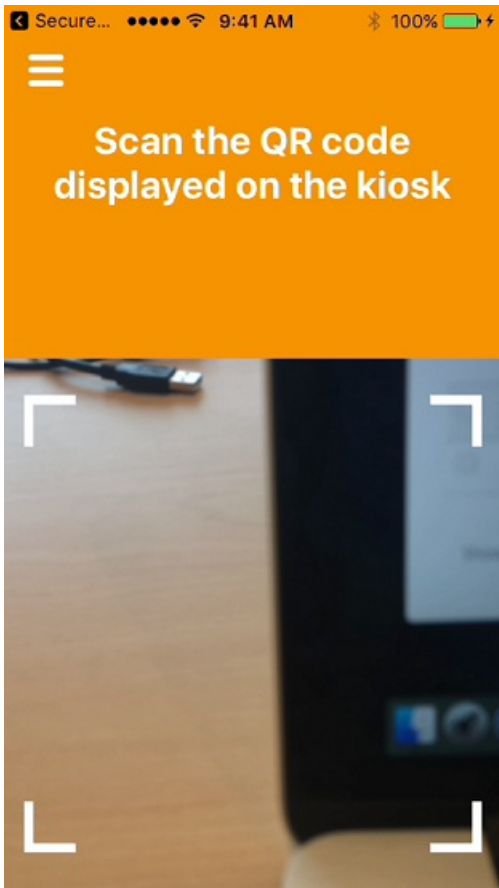

4. The user inserts their card into the smart card reader that's attached to their desktop. The desktop app then displays a QR code and prompts the user to scan the code using their mobile device.

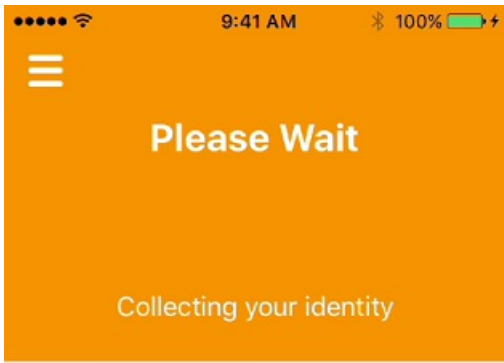

5. The user enters their Secure Hub PIN when prompted.

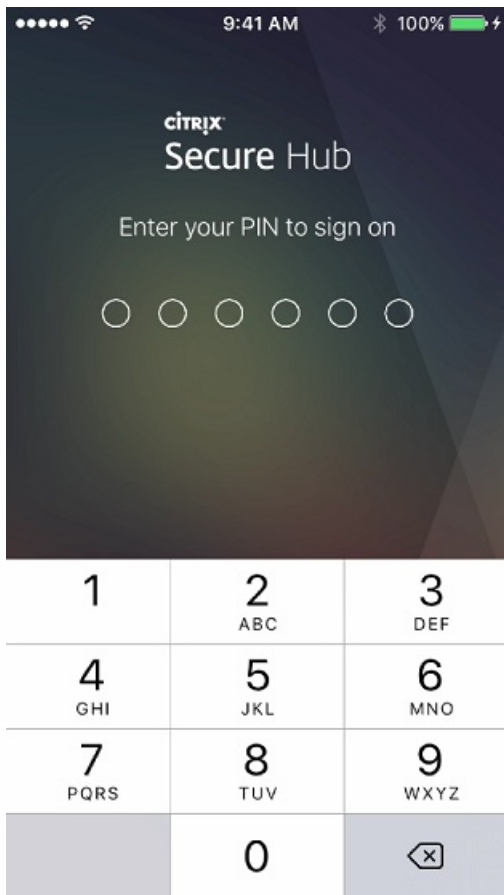

6. After authenticating the PIN, Secure Hub downloads the certificates. The user then follows the prompts to complete enrollment.

To view device information in the XenMobile console:

- Go to **Manage > Devices** and then select a device to display a command box. Click **Show more**.
- Go to **Analyze > Dashboard**.

macOS devices

XenMobile provides two methods to enroll devices that are running macOS. Both methods enable macOS users to enroll over the air, directly from their devices.

- **Send users an enrollment invitation.** This enrollment method enables you to set any of the following enrollment modes for macOS devices:
 - User name + password
 - User name + PIN
 - Two Factor

When the user follows the instructions in the enrollment invitation, a sign-on screen with the user name filled in

appears.

- **Send users an installation link.** This enrollment method for macOS devices sends users an enrollment link, which they open in Safari. A user then enrolls by providing their user name and password.

To prevent the use of an enrollment link for macOS devices, set the server property, **Enable macOS OTAE** to **false**. As a result, macOS users can enroll only by using an enrollment invitation.

Send users an enrollment invitation

1. Optionally set up macOS device policies in the XenMobile console. For more information about device policies, see [Device Policies](#). To find out which device policies you can configure for macOS, see [Device policies by platform](#).
2. Add an invitation for macOS user enrollment. For more information, see [Send an enrollment invitation](#) in this article.
3. After users receive the invitation and click the link, the following screen appears in the Safari browser. XenMobile fills in the user name. If you chose **Two Factor** for the enrollment mode, another field appears.

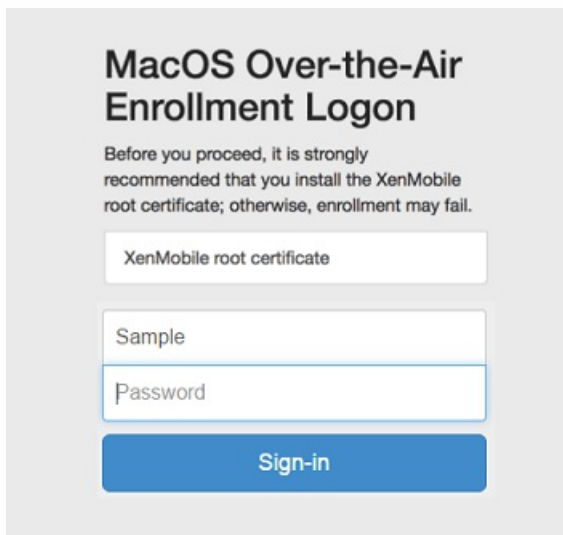

MacOS Over-the-Air Enrollment Logon

Before you proceed, it is strongly recommended that you install the XenMobile root certificate; otherwise, enrollment may fail.

XenMobile root certificate

Sample

Password

Sign-in

4. Users install certificates as necessary. Whether users see the prompt to install certificates depends on whether you configured the following for macOS: A publicly trusted SSL certificate and a publicly trusted digital signing certificate. For more information about certificates, see [Certificates and authentication](#).
5. Users provide the requested credentials.

The Mac device policies install. You can now start managing Macs with XenMobile just as you manage mobile devices.

Send users an installation link

1. Optionally set up macOS device policies in the XenMobile console. For more information about device policies, see [Device Policies](#). To find out which device policies you can configure for macOS, see [Device policies by platform](#).
2. Send the enrollment link `https://serverFQDN:8443/zdm/macos/otae`, which users open in Safari.
 - **serverFQDN** is the fully qualified domain name (FQDN) of the server running XenMobile.
 - Port **8443** is the default secure port. If you configured a different port, use that port instead of 8443.
 - **zdm** is the instance name used during server installation.

For more information about sending installation links, see [To send an installation link](#).

3. Users install certificates as necessary. If you configured a publicly trusted SSL certificate and digital signing certificate for iOS and macOS, users see the prompt to install certificates. For more information about certificates, see [Certificates and authentication](#).
4. Users sign on to their Macs.

The Mac device policies install. You can now start managing Macs with XenMobile just as you manage mobile devices.

Windows devices

Devices running Windows 10 enroll with Azure as a federated means of Active Directory authentication. You can join Windows 10 devices to Microsoft Azure AD in any of the following ways:

- Enroll in MDM as part of Azure AD Join out-of-the-box the first time the device is powered on.
- Enroll in MDM as part of Azure AD Join from the Windows Settings page after the device is configured.

You can enroll devices in XenMobile that are running the following Windows operating systems:

- Windows 10 phone and tablet
- Windows Phone 8.1

Users can enroll directly through their devices.

Note for Windows 10 RS2 Phone and Tablet: During re-enrollment, a user isn't prompted for the Server URL. To work around this issue, restart the device. Or, on the email address screen, tap the X across from "Connecting to a service" to go to the Server URL page. This is a third-party issue.

You must configure autodiscovery and the Windows discovery service for user enrollment to enable the management of supported Windows devices.

Before Windows device users can enroll by using Azure, you must configure the Microsoft Azure server settings in XenMobile. For details, see [Microsoft Azure Active Directory server settings](#).

Note

In order for Windows devices to enroll, the SSL listener certificate must be a public certificate. Enrollment fails if you've uploaded a self-signed SSL certificate.

To enroll Windows devices with self-discovery

To enable management of Windows devices, Citrix recommends you configure autodiscovery and the Windows discovery service. For details, see [Enable autodiscovery](#).

1. On the device, check for and install all available Windows Updates.
2. For Windows 10: In the charms menu, tap **Settings** and then tap **Accounts > Access work or school > Connect to work or school**. For Windows 8.1 phones: Tap **PC Settings > Network > Workplace**.

3. Enter your corporate email address and then tap **Continue** on Windows 10 or tap **Turn on device management** on Windows 8.1. To enroll as a local user, enter a nonexistent email address with the correct domain name (for example, foo@mydomain.com). This permits you to bypass a known Microsoft limitation where enrollment is performed by the built-in Device Management on Windows; in the **Connecting to a service** dialog box, enter the user name and password associated with the local user. The device automatically discovers a XenMobile Server and starts the enrollment process.

4. Enter your password. Use the password associated with an account that is part of a user group in XenMobile.

5. For Windows 10: In the **Terms of use** dialog box, indicate that you agree to have your device managed and then tap **Accept**. For Windows 8.1: In the **Allow apps and services from IT admin** dialog box, indicate that you agree to have your device managed and then tap **Turn on**.

To enroll Windows devices without self-discovery

It is possible to enroll Windows devices without autodiscovery. Citrix, however, recommends that you configure autodiscovery. Enrollment without autodiscovery results in a call to port 80 before connecting to the desired URL, so it is not considered best practice for production deployment. Citrix recommends that you use this process only in test environments and proof of concept deployment.

1. On the device, check for and install all available Windows Updates.

2. For Windows 10: In the charms menu, tap **Settings** and then tap **Accounts > Access work or school > Connect to work or school**. For Windows 8.1: Tap **PC Settings > Network > Workplace**.

3. Enter your corporate email address.

4. For Windows 10: If autodiscovery is not configured, an option appears where you can enter the server details, as described in step 5. For Windows 8.1: If **Automatically detect server address** is set to **on**, tap to turn the option **off**.

5. For Windows 10: In the **Enter server address** field, type the address in the following format.

`https://example.com:8443/zdm/xyz.`

If a port other than 8443 is used for unauthenticated SSL connections, use that port number in place of 8443 in this address.

For Windows 8.1: Type the server address in the following format:

`https://serverfqdn:8443/serverInstance/Discovery.svc.`

If a port other than 8443 is used for unauthenticated SSL connections, use that port number in place of 8443 in this address.

6. Type your password.

7. For Windows 10: In the **Terms of use** dialog box, indicate that you agree to have your device managed and then tap **Accept**. For Windows 8.1: In the **Allow apps and services from IT admin** dialog box, indicate that you agree to have your device managed and then tap **Turn on**.

To enroll Windows Phone devices

To enroll Windows Phone devices in XenMobile, users need their Active Directory or internal network email address, and password. If autodiscovery is not set up, users also need the server web address for the XenMobile Server. Then, they follow this procedure on their devices to enroll.

Note: If you plan to deploy apps through the Windows Phone company store, before your users enroll, ensure that you have configured an [Enterprise Hub](#) policy (with a signed Secure Hub, Windows Phone app for each platform you support).

1. On the main screen of the Windows phone, tap the **Settings** icon.

- For Windows 10: Depending on your version, either tap **Accounts > Access work or school > Connect to work or school** or tap **Accounts > Work access > Enroll in to device management**.
- For Windows 8.1: Tap **PC Settings > Network > Workplace**, and then tap **Add Account**.

2. On the next screen, enter an email address and password and then tap **sign in**.

If autodiscovery is configured for your domain, the information requested in the next several steps is automatically populated. Proceed to Step 8.

If autodiscovery is not configured for your domain, continue with the next step. To enroll as a local user, enter a non-existent email address with the correct domain name (for example, foo@mydomain.com). This permits you to bypass a known Microsoft limitation; in the **Connecting to a service** dialog box, enter the user name and password associated with the local user.

3. On the next screen, type the web address of the XenMobile Server, such as: https://<xenmobile_server>:<portnumber>/<instancename>/wpe. For example, https://mycompany.mdm.com:8443/zdm/wpe. **Note:** The port number has to be adapted to your implementation. It must be the same port that you used for an iOS enrollment.

4. Enter the user name and domain if authentication is validated through a user name and domain and then tap **sign in**.

5. If a screen appears noting a problem with the certificate, the error is the result of using a self-signed certificate. If the server is trusted, tap **continue**. Otherwise, tap **Cancel**.

6. On Windows Phone 8.1, when the account is added, you have the option of selecting **Install company app**. If your administrator has configured a Company App store, select this option and then tap **done**. If you clear this option, you will need to re-enroll your device to receive the Company app store.

7. On Windows Phone 8.1, on the **Account Added** screen, tap **done**.

8. To force a connection to the server, tap the refresh icon. If the device does not manually connect to the server, XenMobile attempts to reconnect. XenMobile connects to the device every 3 minutes 5 successive times, then every 2 hours afterward. You can alter this connection rate in the **Windows WNS Heartbeat Interval** located in **Server properties**. Once enrollment is complete, Secure Hub enrolls in the background. No indicator appears when the installation is complete. Tap Secure Hub from the **All Apps** screen.

Send an enrollment invitation

In the XenMobile console, you can send an enrollment invitation to users with iOS, macOS, and Android devices. You can also send an installation link to users with iOS or Android devices.

Enrollment invitations are sent as follows:

- If the enrollment invitation is for one local or Active Directory user: The user receives the invitation from SMS at the phone number and carrier name you specify.
- If the enrollment invitation is for a group: The users receive invitations from SMS. If Active Directory users have an email address and mobile phone number in Active Directory, they receive the invitation. Local users receive the invitation at the email and phone number specified in user properties.

After users enroll, their devices appear as managed on **Manage > Devices**. The status of the invitation URL is shown as **Redeemed**.

Prerequisites

- XenMobile Server configured in Enterprise (XME) or MDM mode
- LDAP configured
- If using local groups and local users:
 - One or more local groups.
 - Local users assigned to local groups.
 - Delivery groups are associated with local groups.
- If using Active Directory:
 - Delivery groups are associated with Active Directory groups.

Create an enrollment invitation

1. In the XenMobile console, click **Manage > Enrollment Invitations**. The **Enrollment Invitations** page appears.

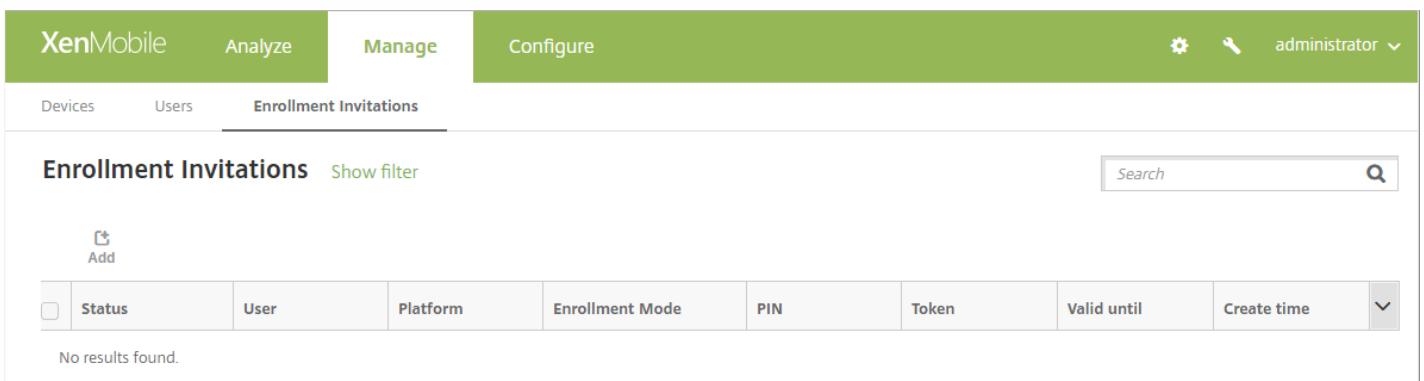

2. Click **Add**. A menu of enrollment options appears.

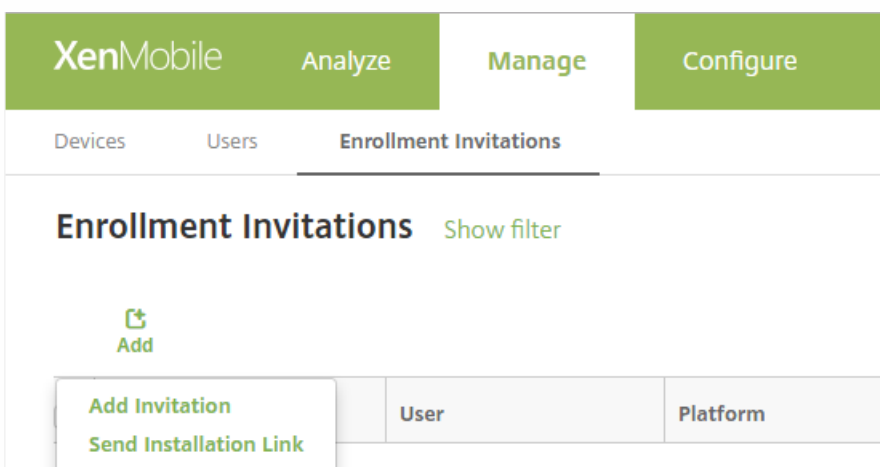

- To send an enrollment invitation to a user or group, click **Add Invitation**.
- To send an enrollment installation link to a list of recipients over SMTP or SMS, click **Send Installation Link**.

Sending enrollment invitations and installation links are described after these steps.

3. Click **Add Invitation**. The **Enrollment Invitation** screen appears.

4. Configure these settings:

- **Recipient:** Choose **Group** or **User**.
- **Select a platform:** If **Recipient** is **Group**, all platforms are selected. You can change the platform selection. If **Recipient** is **User**, no platforms are selected. Select a platform.
- **Device ownership:** Select **Corporate** or **Employee**.

Settings for users or groups appear, as described in the following sections.

To send an enrollment invitation to a user

The screenshot shows the XenMobile configuration interface for an Enrollment Invitation. The top navigation bar includes 'XenMobile', 'Analyze', 'Manage', and 'Configure'. The user is logged in as 'administrator'. The main content area is titled 'Enrollment Invitation' and contains the following settings:

- Recipient***: User (dropdown)
- Select a platform***: Android, iOS, macOS
- Device ownership**: Select an ownership type (dropdown)
- User name***: [Text input field]
- Enrollment mode***: User name + Password (dropdown)
- Template for agent download**: Select a template (dropdown)
- Template for enrollment URL**: Select a template (dropdown)
- Template for enrollment confirmation**: Select a template (dropdown)
- Expire after**: Never
- Maximum Attempts**: 0
- Send invitation**: OFF (toggle)

1. Configure these **User** settings:

- **User name:** Type a user name. The user must exist in the XenMobile Server as a local user or as a user in Active Directory. If the user is local, ensure that the email property of the user is set so you can send that user notifications. If the user is in Active Directory, ensure that LDAP is configured.
- **Device info:** This setting doesn't appear if you select multiple platforms or if you select only macOS. Choose **Serial number**, **UDID**, or **IMEI**. After you choose an option, a field appears where you can type the corresponding value for the device.
- **Phone number:** This setting doesn't appear if you select multiple platforms or if you select only macOS. Optionally, type the phone number of the user.
- **Carrier:** This setting doesn't appear if you select multiple platforms or if you select only macOS. Choose a carrier to associate to the phone number of the user.
- **Enrollment mode:** Choose how you want users to enroll. The default is **User name + Password**. Some of the following options aren't available for all platforms:
 - User name + Password
 - High Security
 - Invitation URL
 - Invitation URL + PIN
 - Invitation URL + Password
 - Two Factor
 - User name + PIN

Only the enrollment modes that are valid for each of the selected platforms appear. A PIN for enrollment is also called a one-time PIN. Such PINs are valid only when the user enrolls.

Note: When you select any enrollment mode that includes a PIN, the **Template for enrollment PIN** field appears, where you click **Enrollment PIN**.

- **Template for agent download:** Choose the download link template named **Download link**. That template is for all supported platforms.
- **Template for enrollment URL:** Choose **Enrollment Invitation**.
- **Template for enrollment confirmation:** Choose **Enrollment Confirmation**.
- **Expire after:** This field is set when you configure the Enrollment Mode and indicates when the enrollment expires. For more information about configuring enrollment modes, see [To configure enrollment modes](#).
- **Maximum Attempts:** This field is set when you configure the **Enrollment Mode** and indicates the maximum number of times the enrollment process occurs. For more information about configuring enrollment modes, see [To configure enrollment modes](#).
- **Send invitation:** Select **ON** to send the invitation immediately. Select **OFF** to add the invitation to the table on the **Enrollment Invitations** page, but not send it.

2. Click **Save and Send** if you enabled **Send invitation**. Otherwise, click **Save**. The invitation appears in the table on the **Enrollment Invitations** page.

<input type="checkbox"/>	Status	User	Platform	Enrollment Mode	PIN	Token	Valid until	Create time	
<input type="checkbox"/>	PENDING	[redacted]	Android	User name + Password		ep-f906c76b-062a-4568-[redacted]		05/03/2017 10:32:24 am	
<input type="checkbox"/>	PENDING	[redacted]	macOS	User name + Password		ep-e7004313-22b6-4607-[redacted]		05/01/2017 07:33:38 pm	
<input type="checkbox"/>	PENDING	[redacted]	iOS	User name + Password		ep-4d482bdf-6016-[redacted]		05/01/2017 07:29:02 pm	

To send an enrollment invitation to a group

The screenshot shows the XenMobile configuration interface for an Enrollment Invitation. The top navigation bar includes 'XenMobile', 'Analyze', 'Manage', and 'Configure'. The user is logged in as 'administrator'. The main content area is titled 'Enrollment Invitation' and contains the following settings:

- Recipient***: Group
- Select a platform***: Android, iOS, macOS
- Device ownership**: Select an ownership type
- Domain***: Select a domain
- Group***: Select a group
- Enrollment mode***: User name + Password
- Template for agent download**: Select a template
- Template for enrollment URL**: Select a template
- Template for enrollment confirmation**: Select a template
- Expire after**: Never
- Maximum Attempts**: 0
- Send invitation**: OFF

1. Configure these settings:

- **Domain:** Choose the domain of the group to receive the invitation.
- **Group:** Choose the group to receive the invitation.
- **Enrollment mode:** Choose how you want users in the group to enroll. The default is **User name + Password**. Some of the following options aren't available for all platforms:
 - User name + Password
 - High Security
 - Invitation URL
 - Invitation URL + PIN
 - Invitation URL + Password
 - Two Factor
 - User name + PIN

Only the enrollment modes that are valid for each of the selected platforms appear.

Note: When you select any enrollment mode that includes a PIN, the **Template for enrollment PIN** field appears, where you click **Enrollment PIN**.

- **Template for agent download:** Choose the download link template named **Download link**. That template is for all supported platforms.
- **Template for enrollment URL:** Choose **Enrollment Invitation**.
- **Template for enrollment confirmation:** Choose **Enrollment Confirmation**.
- **Expire after:** This field is set when you configure the Enrollment Mode and indicates when the enrollment expires. For

more information about configuring enrollment modes, see [To configure enrollment modes](#).

- **Maximum Attempts:** This field is set when you configure the Enrollment Mode and indicates the maximum number of times the enrollment process occurs. For more information about configuring enrollment modes, see [To configure enrollment modes](#).
- **Send invitation:** Select **ON** to send the invitation immediately. Select **OFF** to add the invitation to the table on the **Enrollment Invitations** page, but not send it.

2. Click **Save and Send** if you enabled **Send invitation**. Otherwise, click **Save**. The invitation appears in the table on the **Enrollment Invitation** page.

The screenshot shows the XenMobile interface with the 'Manage' tab selected and 'Configure' sub-tab active. The 'Devices' section is visible, showing a table of enrolled devices. The table has columns for Status, Mode, User name, Serial number, Device platform, Operating system version, Device model, Last access, Inactivity days, and DEP account name. Three devices are listed: an iPad and two iPhones, all running iOS 10.1.1. The iPad was last accessed on 01/20/2017 at 02:00:09 pm and is inactive for 2 days. The first iPhone was last accessed on 12/15/2016 at 05:14:24 pm and is inactive for 38 days. The second iPhone was last accessed on 01/20/2017 at 02:51:41 pm and is inactive for 2 days. All devices are associated with the 'Default DEP Account'.

Status	Mode	User name	Serial number	Device platform	Operating system version	Device model	Last access	Inactivity days	DEP account name
<input type="checkbox"/>	MDM MAM	[redacted] net	[redacted]	iOS	10.1.1	iPad	01/20/2017 02:00:09 pm	2 days	Default DEP Account
<input type="checkbox"/>	MDM MAM	[redacted] net	[redacted]	iOS	10.1.1	iPhone	12/15/2016 05:14:24 pm	38 days	
<input type="checkbox"/>	MDM MAM	[redacted] net	[redacted]	iOS	10.1.1	iPhone	01/20/2017 02:51:41 pm	2 days	

To send an installation link

The screenshot shows the 'Send Link' configuration page in XenMobile. The 'Send Installation Link' section is active. It features a 'Recipients*' table with columns for 'Email*' and 'Phone number*', and an 'Add' button. Below this, there are two channel options: 'SMTP' and 'SMS'. Both channels have a warning message: 'Channel cannot be activated until you define the [SMTP/SMS] server in the Notification Server section in Settings.' The 'SMTP' channel has fields for 'Sender', 'Subject' (pre-filled with 'Enroll Your Device'), and 'Message' (pre-filled with 'Enroll your device to gain access to company email and intranet. For instructions visit: \${zdmserver.hostPath}/enroll'). The 'SMS' channel has a 'Message' field pre-filled with 'Download XenMobile Agent: \${zdmserver.hostPath}/enroll'.

Before you can send an enrollment installation link, you must configure channels (SMTP or SMS) on the notification server from the **Settings** page. For details, see [Notifications](#).

1. Configure these settings:

- **Recipient:** For each recipient that you want to add, click Add and do the following:
 - **Email:** Type the email address of the recipient. This field is required.
 - **Phone number:** Type the phone number of the recipient. This field is required.
 - Click **Save**.

Note: To delete an existing recipient, hover over the line containing the listing and then click the trash icon on the right side. A confirmation dialog box appears. Click **Delete** to delete the listing or click **Cancel** to keep the listing.

To edit an existing recipient, hover over the line containing the listing and then click the pen icon on the right-hand side. Update the listing and then click **Save** to save the changed listing or **Cancel** to leave the listing unchanged.

- **Channels:** Select a channel to use for sending the enrollment installation link. You can send notifications over **SMTP** or **SMS**. These channels cannot be activated until you configure the server settings on the **Settings** page in **Notification Server**. For details, see [Notifications](#).
 - **SMTP:** Configure these optional settings. If you do not type anything in these fields, the default values specified in the notification template configured for the platform you selected are used:
 - **Sender:** Type an optional sender.
 - **Subject:** Type an optional subject for the message. For example, "Enroll your device."
 - **Message:** Type an optional message to be sent to the recipient. For example, "Enroll your device to gain access to organizational apps and email."
 - **SMS:** Configure this setting. If you do not type anything in this field, the default value specified in the notification template configured for the platform you selected is used:
 - **Message:** Type a message to be sent to the recipients. This field is required for SMS-based notification.

Note: In North America, SMS messages that exceed 160 characters are delivered in multiple messages.

2. Click **Send**.

Note

If your environment uses sAMAccountName: After users receive the invitation and click the link, they must edit the user name to complete the authentication. The user name appears in the form of sAMAccountName@domainname.com. Users must remove the @domainname.com portion.

Firestore Cloud Messaging

Jun 19, 2017

Alternative to the **Active poll period** policy, you can use Firestore Cloud Messaging (FCM) to control how and when Android devices connect to XenMobile. By using the following configuration, any security action or deploy command triggers a push notification to prompt the user to reconnect to the XenMobile Server.

Prerequisites

- XenMobile 10.3.x
- Latest Secure Hub client
- Google developer account credentials
- Open port 443 on XenMobile to Android.apis.google.com and Google.com

Architecture

This diagram shows the communication flow for FCM in the external and internal network.

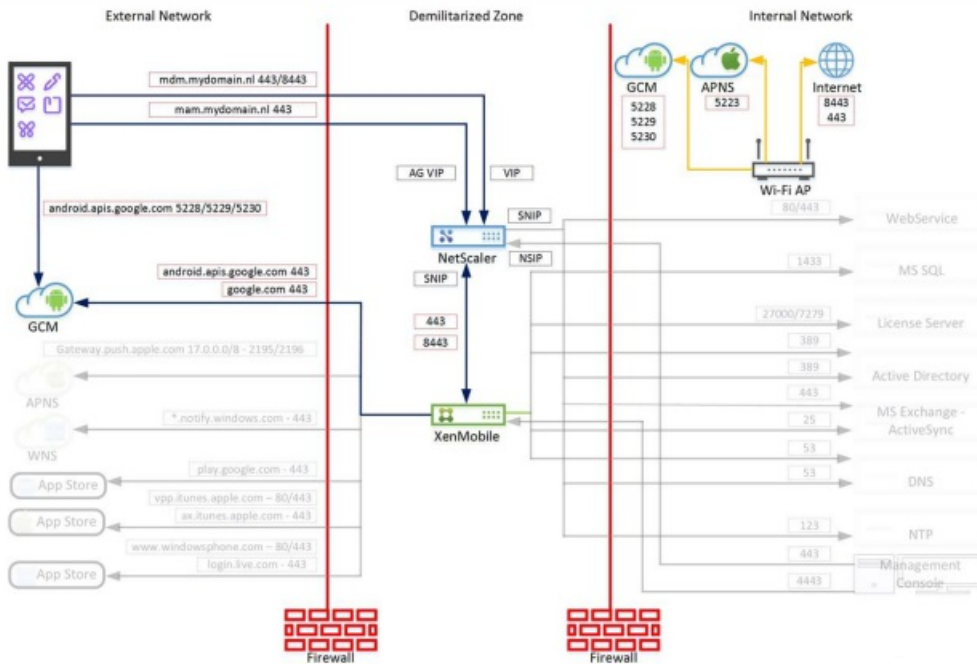

To configure your Google account for GCM

1. Sign in to the following URL using your Google developer account credentials:

<https://console.firebase.google.com/?pli=1>

2. Click **Create a project**.

Welcome to Firebase

Tools from Google for developing great apps, engaging with your users and earning more through mobile ads. [Learn more](#)

CREATE NEW PROJECT

[or import a Google project](#)

3. Type a **Project name** and then click **Create Project**.

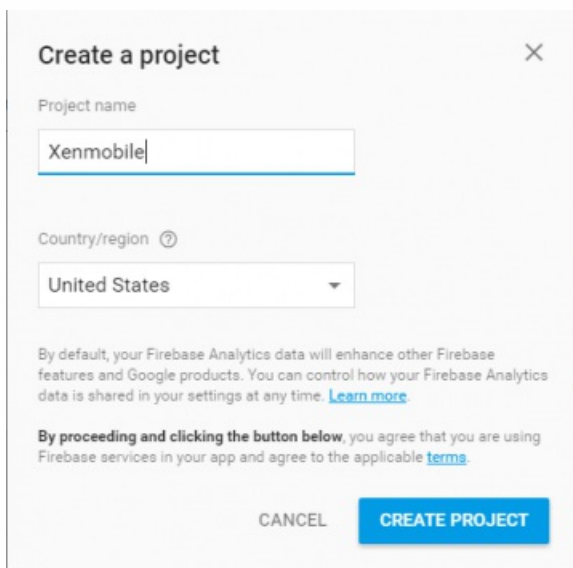

Create a project ✕

Project name

Country/region 🌐

United States

By default, your Firebase Analytics data will enhance other Firebase features and Google products. You can control how your Firebase Analytics data is shared in your settings at any time. [Learn more](#)

By proceeding and clicking the button below, you agree that you are using Firebase services in your app and agree to the applicable [terms](#).

CANCEL **CREATE PROJECT**

4. Click the gear icon next to your project name in the top left and click **Project Settings**.

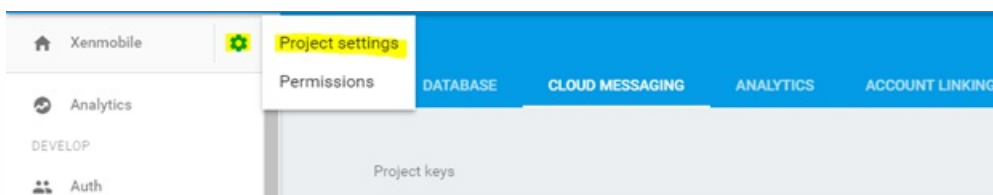

5. Select the **Cloud Messaging** tab. You can find your sender ID and Server Key on this page. Copy these values because you must provide them in XenMobile Server. It is important to note that any Server Keys created after September 2016 must be created in the Firebase console.

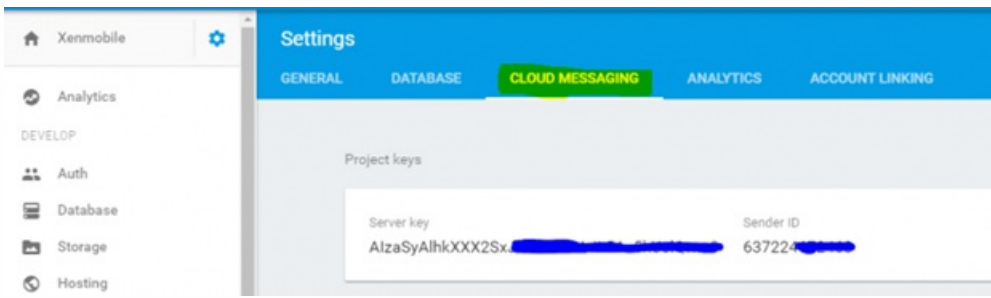

To configure XenMobile for GCM

1. Sign in to XenMobile console and then click **Settings** > **Server Properties**. In the search bar, type **GCM** and click search.
 - a. Edit **GCM API key**, and type the Firebase Cloud Messaging API key that you copied in the last step of Firebase Cloud Messaging configuration.
 - b. Edit **GCM Sender ID**, and type the Sender ID value you noted in the previous procedure.

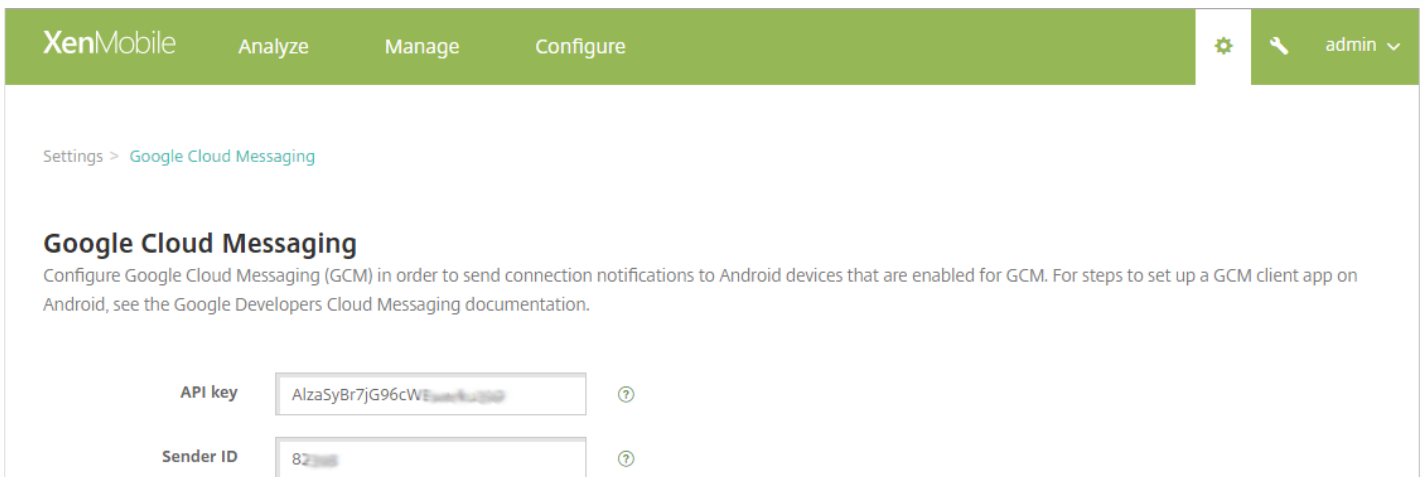

To test your configuration

As a prerequisite to test your FCM configuration, do not have a **Scheduling** policy configured. Alternatively, do not set the policy to **Always Connect**. For more information about configuring the **Scheduling** policy, see [Scheduling device policy](#).





1. Enroll an Android device.
2. Leave the device idle for some time, so that it disconnects from XenMobile Server.
3. Sign in to the XenMobile console, click **Manage**, select the Android device, and then click **Secure**.

XenMobile Analyze **Manage** Configure administrator

Devices Users Enrollment Invitations

Devices Show filter Search

Add Edit Secure Notify Delete Import Export Refresh

<input type="checkbox"/>	Status	Mode	User name	Device platform	Operating system version	Device model	Last access	Inactivity days	DEP registered	Activation
<input checked="" type="checkbox"/>	  	MDM MAM		Android	6.0.1	Nexus 9	07/27/2016 06:05:25 pm	2 days	No	

4. Under **Device Actions**, click **Selective Wipe**.

Security Actions

Device Actions

Revoke Lock **Selective Wipe** Full Wipe

Locate

In a successful configuration, selective wipe occurs on the device.

Google Play credentials

Jun 19, 2017

XenMobile uses Google Play credentials to extract app information for the device.

To locate your Android ID, enter `***#8255***` on your phone. If the code does not reveal the device ID on your device type, it might be possible to use a third-party app to derive the device ID. The ID to retrieve is the Google Services Framework ID with the label GSF ID.

Note

When searching for Google Play Store apps in the XenMobile console, the search returns apps based on the Android operating system of the device. For example, a Samsung S6 Edge is running an operating system version 6.0.1. When you search for apps, the only apps that appear in the search result are apps that are compatible with Android version 6.0.1.

Important

To enable XenMobile to extract app information, you might need to configure your Gmail account to permit unsecure connections. For steps, see the [Google](#) support site.

1. In the XenMobile console, click the gear icon in the upper-right corner. The **Settings** page appears.
2. Under **Platforms**, click **Google Play Credentials**. The Google Play Credentials page appears.

The screenshot shows the XenMobile console interface. At the top, there is a navigation bar with the XenMobile logo and menu items: Analyze, Manage, and Configure. On the right side of the navigation bar, there is a gear icon for settings and a user profile icon labeled 'admin'. Below the navigation bar, the breadcrumb trail reads 'Settings > Google Play Credentials'. The main heading is 'Google Play Credentials'. Below the heading, a message states: 'XenMobile cannot extract app information without logon information. To find your Android ID, you can type `***#8255***` on your phone.' There are three input fields: 'User name*' with the value '@gmail.com', 'Password*' with masked characters, and 'Device ID*' with the value '123456789123CD01'. At the bottom right, there are 'Cancel' and 'Save' buttons.

3. Configure these settings:

- **User name:** Type the name associated with the Google Play account.

- **Password:** Type the user password.
- **Device ID:** Type your Android ID.
See the Note earlier in the article for steps on obtaining your Android ID.

3. Click **Save**.

Network Access Control

Jun 19, 2017

If you have a Network Access Control (NAC) appliance set up in your network, such as a Cisco ISE, in XenMobile, you can enable filters to set devices as compliant or not compliant for NAC, based on rules or properties. If a managed device in XenMobile does not meet the specified criteria, and as a result is marked Not Compliant, the NAC appliance will block the device on your network.

In the XenMobile console, you select one or more criterion in the list to set a device as not compliant.

XenMobile supports the following NAC compliance filters:

Anonymous Devices: Checks if a device is in anonymous mode. This check is available if XenMobile can't re-authenticate the user when a device attempts to reconnect.

Failed Samsung KNOX attestation: Checks if a device failed a query of the Samsung KNOX attestation server.

Forbidden Apps: Checks if a device has forbidden apps, as defined in an App Access policy. For more information about the App access policy, see [App access device policies](#).

Inactive Devices: Checks if a device is inactive as defined by the Device Inactivity Days Threshold setting in Server Properties. For details, see [Server properties](#).

Missing Required Apps: Checks if a device is missing required apps, as defined in an App Access policy.

Non-suggested Apps: Checks if a device has non-suggested apps, as defined in an App Access policy.

Noncompliant Password: Checks if the user password is compliant. On iOS and Android devices, XenMobile can determine whether the password currently on the device is compliant with the passcode policy sent to the device. For instance, on iOS, the user has 60 minutes to set a password if XenMobile sends a passcode policy to the device. Before the user sets the password, the passcode might be non-compliant.

Out of Compliance Devices: Checks whether a device is out of compliance, based on the Out of Compliance device property. That property is usually changed by the automated actions or by a third party making use of XenMobile APIs.

Revoked Status: Checks whether the device certificate was revoked. A revoked device cannot re-enroll until it is authorized again.

Rooted Android and jailbroken iOS Devices: Checks whether an Android or iOS device is jailbroken.

Unmanaged Devices: Check whether a device is still in a managed state, under XenMobile control. For example, a device running in MAM mode or an un-enrolled device is not managed.

Note

The Implicit Compliant/Not Compliant filter sets the default value only on devices that are managed by XenMobile. For example, any devices that have a blacklisted app installed or are not enrolled, are marked as Not-Compliant and will be blocked from your network by the NAC appliance.

Configure Network Access Control

1. In the XenMobile console, click the gear icon in the upper-right corner. The **Settings** page appears.
2. Under **Server**, click **Network Access Control**. The **Network Access Control** page appears.

The screenshot shows the XenMobile console interface. At the top, there is a green navigation bar with the XenMobile logo and tabs for 'Analyze', 'Manage', and 'Configure'. A gear icon and a user profile 'admin' are visible on the right. Below the navigation bar, the breadcrumb 'Settings > Network Access Control' is shown. The main heading is 'Network Access Control' with the subtext 'Enables device compliance.' Underneath, there is a section titled 'Set as not compliant:' followed by a list of ten checkboxes, each with a corresponding label: 'Anonymous Devices', 'Failed Samsung KNOX attestation', 'Forbidden Apps', 'Inactive Devices', 'Missing Required Apps', 'Non-Suggested Apps', 'Noncompliant Password', 'Out of Compliance Devices', 'Revoked Status', 'Rooted Android and Jailbroken iOS Devices', and 'Unmanaged Devices'. At the bottom right of the configuration area, there are two buttons: 'Cancel' and 'Save'.

3. Select the check boxes for the **Set as not compliant** filters you want to enable.
4. Click **Save**.

Samsung KNOX

Jun 19, 2017

You can configure XenMobile to query the Samsung KNOX attestation server REST APIs.

Samsung KNOX leverages hardware security capabilities that provide multiple levels of protection for the operating system and applications. One level of this security resides at the platform through attestation. An attestation server provides verification of the mobile device core system software (for example, the boot loaders and kernel). The verification occurs at runtime based on data collected during trusted boot.

1. In the XenMobile web console, click the gear icon in the upper-right corner. The **Settings** page appears.
2. Under **Platforms**, click **Samsung KNOX**. The **Samsung KNOX** page appears.

The screenshot displays the XenMobile web console interface for configuring Samsung KNOX. The top navigation bar includes 'XenMobile', 'Analyze', 'Manage', and 'Configure', along with a gear icon and a user profile 'admin'. The main content area shows the 'Settings > Samsung KNOX' path. The title 'Samsung KNOX' is followed by the description: 'This configuration allows XenMobile server to query Samsung KNOX attestation server REST APIs.' The 'Enable Samsung KNOX attestation' toggle is currently set to 'NO'. The 'Web service URL' section is active, featuring a dropdown menu with 'Add new' and a text input field containing 'https://us-attest-api.knox'. A green 'Test Connection' button is positioned to the right of the URL field. At the bottom right, there are 'Cancel' and 'Save' buttons.

3. In **Enable Samsung KNOX attestation**, select whether to enable Samsung KNOX attestation. The default is **NO**.
4. When you set **Enable Samsung KNOX attestation**, to **YES**, the **Web service URL** option is enabled. Then, in the list, do one of the following:
 - a. Click the appropriate attestation server.
 - b. Click **Add new** and then enter the Web service URL.
5. Click **Test Connection** to verify the connection. A success or failure message appears.
6. Click **Save**.

Note

You can use Samsung KNOX Mobile Enrollment to enroll multiple Samsung KNOX devices into XenMobile (or any mobile device

manager) without manually configuring each device. For information, see [Samsung KNOX Bulk Enrollment](#).

Security actions

Jul 24, 2017

You perform device and app security actions from the **Manage > Devices** page. Device actions include revoke, lock, unlock, and wipe. App security actions include app lock and app wipe.

- **Activation Lock Bypass:** Removes the Activation Lock from supervised iOS devices before device activation. This command doesn't require the personal Apple ID or password for a user.
- **App Lock:** Denies access to all apps on a device. On Android, after an app lock, users can't sign in to XenMobile. On iOS, users can sign in, but they can't access apps.
- **App Wipe:** On Android, an app wipe deletes the user account from XenMobile. On iOS, deletes a user account in Secure Hub.
- **Clear Restrictions:** On supervised iOS devices, this command allows XenMobile Server to clear the restrictions password and restrictions settings configured by the user.
- **Enable/Disable Lost Mode:** Puts a supervised iOS device in Lost Mode and sends the device a message, phone number, and footnote to display. The second time that you send this command takes the device out of Lost Mode.
- **Full Wipe:** Immediately erases all data and apps from a device, including from any memory cards.
 - For Android devices, this request can also include the option to wipe memory cards.
 - For iOS and macOS devices, the wipe occurs immediately, even if the device is locked.
 - For Windows Phone devices, a full wipe removes all XenMobile information and all user data, including personal content such as apps, emails, contacts, and media.
 - For Windows Mobile devices that are running Windows Mobile 6 or earlier: After the wipe, you might need to send the device back to the manufacturer to reload the original operating system, software, or both.
 - If the device user turns off the device before the memory card content is deleted, the user might still have access to device data.
 - You can cancel the wipe request until the request is sent to the device.
- **Locate:** Locates a device and reports the device location, including a map, on the **Manage > Devices** page, under **Device details > General**.
- **Lock:** Remotely locks a device, which is useful if a device is lost but you aren't sure if it's stolen. XenMobile then generates a PIN code and sets it in the device. To access the device, the user types the PIN code. Use **Cancel Lock** to remove the lock from the XenMobile console
- **Lock and Reset Password:** Remotely locks a device and resets the password.
- **Notify (Ring):** Plays a sound on Android devices.
- **Request/Stop AirPlay Mirroring:** Starts and stops AirPlay mirroring on supervised iOS devices.
- **Revoke:** Prohibits a device from connecting to XenMobile Server.

- **Revoke/Authorize (iOS, macOS):** Performs the same actions as a Selective Wipe. After revocation, you can reauthorize the device to reenroll it.
- **Selective Wipe:** Erases all corporate data and apps from a device, leaving personal data and apps in place. After a selective wipe, a user can reenroll the device.
 - Selectively wiping an Android device does not disconnect the device from Device Manager and the corporate network. To prevent the device from accessing Device Manager, you must also revoke the device certificates.
 - If the Samsung KNOX API is enabled, selectively wiping the device also removes the Samsung KNOX container.
 - For iOS and macOS devices, this command removes any profile installed through MDM.
 - A selective wipe on a Windows device also removes the contents of the profile folder for any currently signed on user. A selective wipe doesn't remove any web clips that you deliver to users through a configuration. To remove web clips, users manually unenroll their devices. You can't reenroll a selectively wiped device.
 - Selectively wiping a Windows Phone device removes the enterprise token that allows XenMobile to install apps on the device. The wipe also removes all XenMobile certificates and configurations deployed to the device. You can't reenroll a selectively wiped Windows Phone device.
- **Unlock:** Clears the passcode sent to the device when it was locked. This command doesn't unlock the device.

The remainder of this article covers these topics:

- [Security actions for Android devices](#)
- [Security actions for iOS and macOS devices](#)
- [Security actions for Windows devices](#)
- [Lock iOS devices](#)
- [Remove a device from the XenMobile console](#)
- [Selectively wipe a device](#)
- [Delete a device](#)
- [Lock, unlock, wipe, or unwipe apps](#)
- [Put iOS devices in Lost Mode](#)

Security actions for Android devices

Security action	Android ¹	Android for Work (BYOD)	Android for Work (corporate-owned)
App Lock	Yes	No	No
App Wipe	Yes	No	No
Full Wipe	Yes	No	Yes

Locate	Yes ²	Yes ²	Yes ²
Lock	Yes	Yes	Yes
Lock and Reset Password	Yes	No	Yes
Notify (Ring)	Yes	Yes	Yes
Revoke	Yes	Yes	Yes
Selective Wipe	Yes	Yes	No

¹ Except for Android for Work devices.

² For devices running Android 6.0+, Locate requires the user to grant Location permission during enrollment. The user can opt not to grant Location permission. If the user doesn't grant the permission during enrollment, XenMobile again requests location permission when sending the Locate command.

Security actions for iOS and macOS devices

Security action	iOS	macOS
Activation Lock Bypass	Yes	No
App Lock	Yes	No
App Wipe	Yes	No
Clear Restrictions	Yes	No
Enable/Disable Lost Mode	Yes	No
Enable/Disable Tracking	Yes	No
Full Wipe	Yes	Yes
Locate	Yes	No

Lock	Yes	Yes
Ring	Yes	No
Request/Stop AirPlay Mirroring	Yes	No
Revoke/Authorize	Yes	Yes
Selective Wipe	Yes	Yes
Unlock	Yes	No

Security actions for Windows devices

Security action	Windows Phone 10	Windows Tablet 10	Windows Phone 8.1
Locate	Yes	Yes	No
Lock	Yes	Yes	Yes
Lock and Reset Password	Yes	No	Yes
Revoke	Yes	Yes	Yes
Ring	Yes	No	Yes
Selective Wipe	Yes	Yes	Yes
Wipe	Yes	No	Yes

The remainder of this article provides the steps for performing various security actions. You can also automate some actions. For more information, see [Automated actions](#).

Lock iOS devices

You can lock a lost iOS device with an accompanying display of a message and phone number that displays on the device

lock screen. This feature is supported on devices running iOS 7 and above.

To display a message and phone number on a locked device, set the [Passcode](#) policy to true in the XenMobile console. Alternatively, users can enable the passcode on the device manually.

1. Click **Manage > Devices**. The **Devices** page displays.



2. Select the iOS device you want to lock.

When you select the check box next to a device, the options menu displays above the device list. When you click anywhere else in the list, the options menu displays on the right side of the listing.

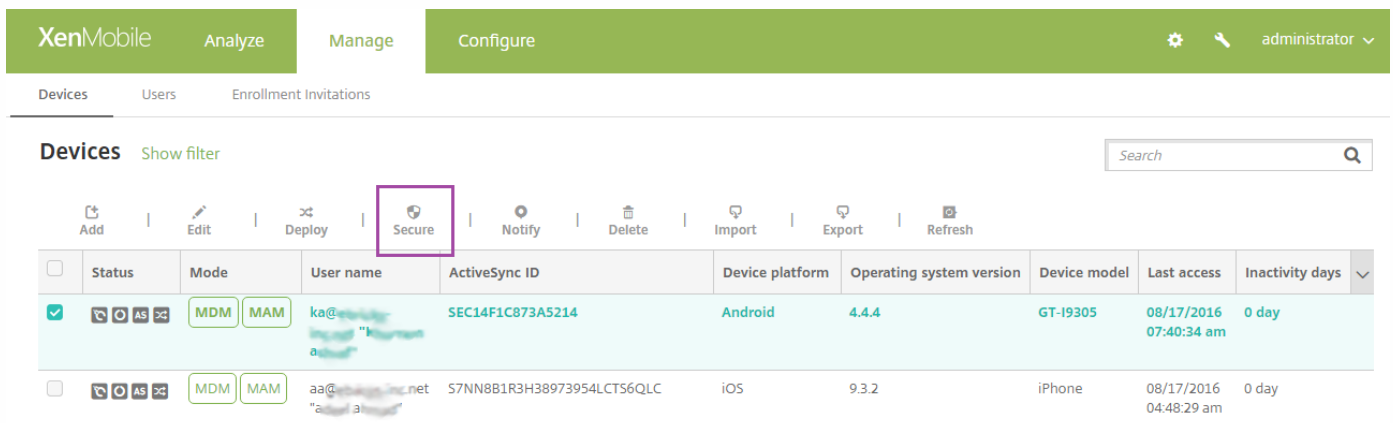

XenMobile Analyze Manage Configure administrator

Devices Users Enrollment Invitations

Devices Show filter Search

Add Import Export Refresh

Status	Mode	User name	ActiveSync ID	Device platform	Operating system version	Device model	Last access	Inactivity days
	MDM MAM	ka@...	SEC14F1C873A5214	Android	4.4.4	GT-I9305	08/17/2016 07:40:34 am	0 day
	MDM MAM	aa@...net	S7NN8B1R3H38973954LCTS6QLC	iOS				

Edit Deploy **Secure** Notify Delete

XME Device Managed

Delivery Groups	2	Policies	5
Actions	2	Apps	15

[Show more >](#)

3. In the options menu, click **Secure**. The **Security Actions** dialog box displays.

Security Actions

Device Actions

Revoke

Lock

Unlock

Selective Wipe

Full Wipe

Enable Tracking

Locate

Request AirPlay Mirroring

4. Click **Lock**. The **Security Actions** confirmation dialog box displays.

Security Actions ✕

Are you sure you want to lock this device?

Message

Phone

Cancel
Lock Device

5. Optionally, type a message and phone number that appears on the lock screen of the device.

For iPads running iOS 7 and later: iOS appends the words “Lost iPad” to what you type in the **Message** field.

For iPhones running iOS 7 and later: If you leave the **Message** field empty and provide a phone number, Apple displays the message “Call owner” on the device lock screen.

Click **Lock Device**.

6.

Remove a device from the XenMobile console

Important

When you remove a device from the XenMobile console, managed apps and data remain on the device. To remove managed apps and data from the device, see "Delete a device" later in this article.

To remove a device from the XenMobile console, go to **Manage > Devices**, select a managed device, and then click **Delete**.

Status	Mode	User name	Serial number	Device platform	Operating system version	Device model	Inactivity days	Available storage space	Device name	XenMobile agent version
<input checked="" type="checkbox"/>	MDM MAM	user1@...	RF2...	Android	5.1.1	SM-T900	0 day	13.05 GB	Android(0)	10.6.0

Selectively wipe a device

1. Go to **Manage > Devices**, select a managed device, and then click **Secure**.

2. In **Security Actions**, click **Selective wipe**.

3. For Android devices only, disconnect the device from the corporate network: After the device is wiped, in **Security Actions**, click **Revoke**.

To withdraw a selective wipe request before the wipe occurs, in **Security Actions**, click **Cancel selective wipe**.

Delete a device

This procedure removes managed apps and data from the device and deletes the device from the Devices list in the XenMobile console.

1. Go to **Manage > Devices**, select a managed device, and then click **Secure**.

2. Click **Selective Wipe**. When prompted, click **Perform Selective Wipe**.

3. To verify that the wipe command succeeded, refresh **Manage > Devices**. In the **Mode** column, the amber color for MDM and MAM indicates that the wipe command succeeded.

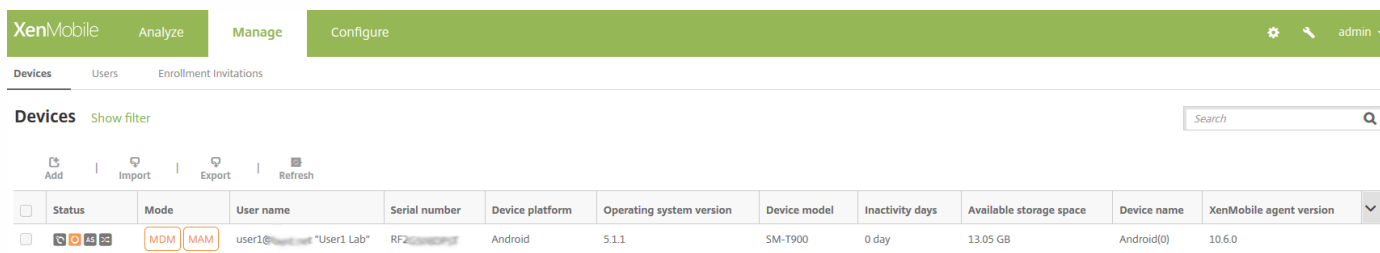

Status	Mode	User name	Serial number	Device platform	Operating system version	Device model	Inactivity days	Available storage space	Device name	XenMobile agent version
<input type="checkbox"/>	MDM MAM	user1@... "User1 Lab"	RF2...	Android	5.1.1	SM-T900	0 day	13.05 GB	Android(0)	10.6.0

4. On **Manage > Devices**, select the device, and then click **Delete**. When prompted, click **Delete** again.

Lock, unlock, wipe, or unwipe apps

1. Go to **Manage > Devices**, select a managed device, and then click **Secure**.

2. In **Security Actions**, click the app action.

You can also use the **Security Actions** box to check the device status for a user whose account is disabled or deleted from Active Directory. The presence of the App Unlock or App Unwipe actions indicate apps that are locked or wiped.

Put iOS devices in Lost Mode

The XenMobile Lost Mode device property puts an iOS device in Lost Mode. Unlike Apple Managed Lost Mode, XenMobile Lost Mode doesn't require a user to perform either of the following actions to enable locating their device: Configure the Find My iPhone/iPad setting or enable the Location Services for Citrix Secure Hub.

In XenMobile Lost Mode, only the XenMobile Server can unlock the device. (In contrast, if you use the XenMobile device lock feature, users can unlock the device directly by using a PIN code that you provide.)

To enable or disable lost mode: Go to **Manage > Devices**, choose a supervised iOS device, and click **Secure**. Then, click **Enable Lost Mode** or **Disable Lost Mode**.

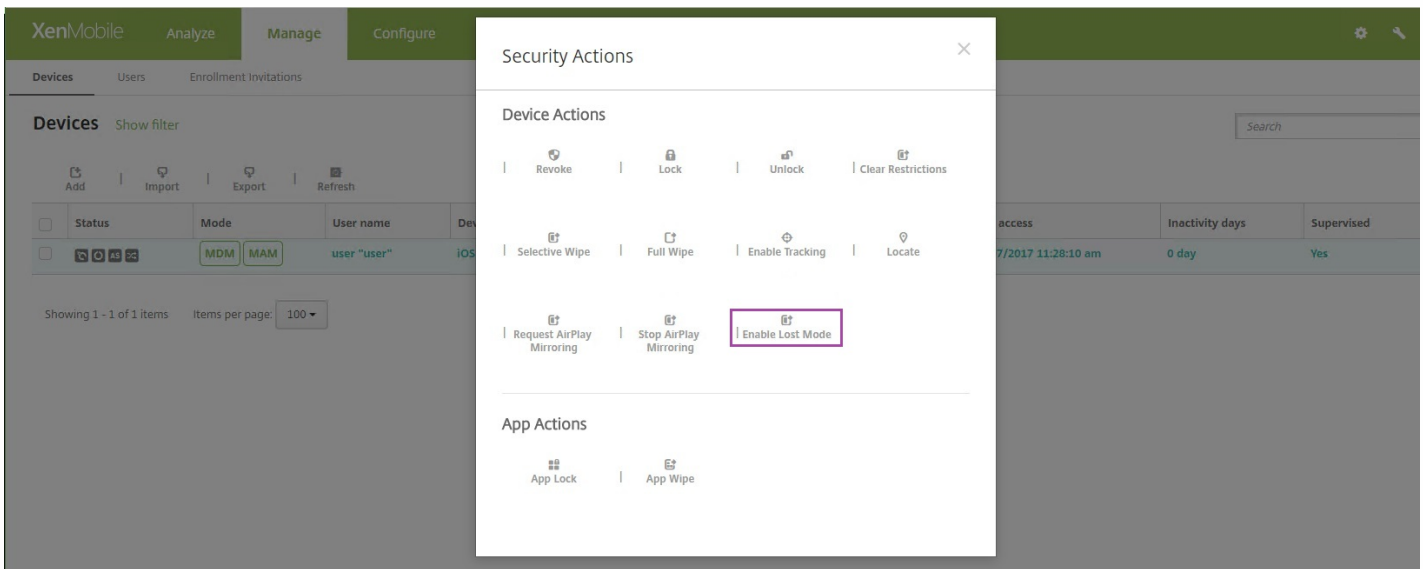

If you click **Enable Lost Mode**, type information to appear on the device when it's in lost mode.

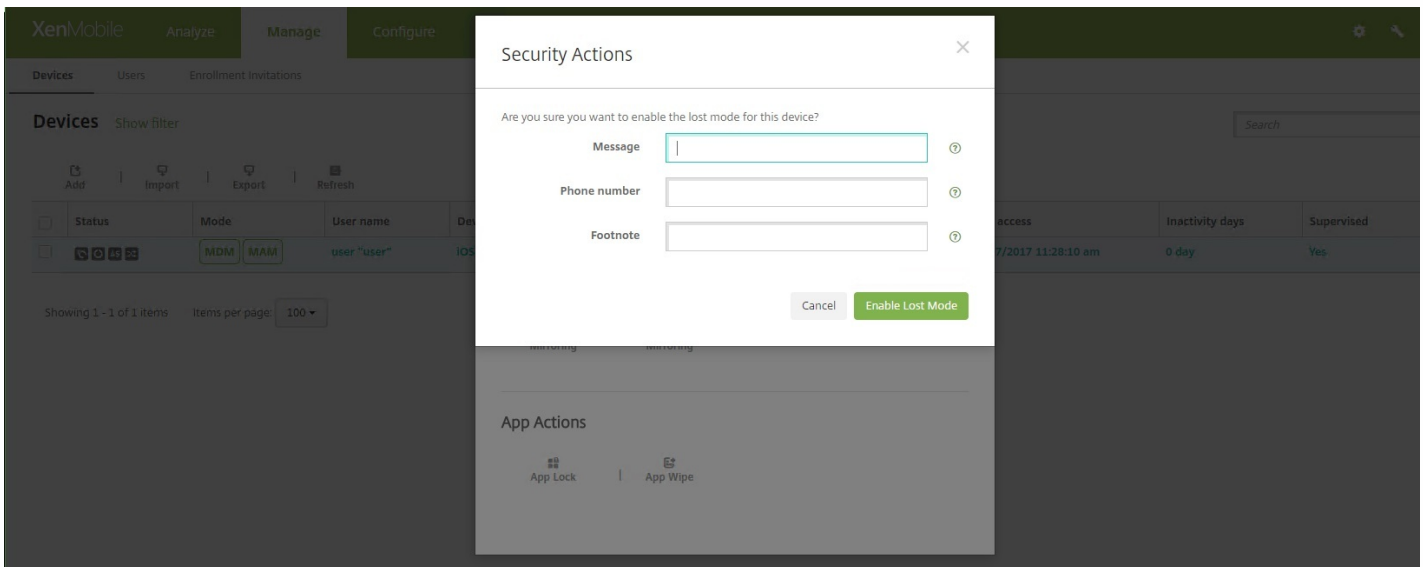

Use any of the following methods to check Lost Mode status:

- In the **Security Actions** window, verify if the button is **Disable Lost Mode**.
- From **Manage > Devices**, on the **General** tab under **Security**, see the last Enable Lost Mode or Disable Lost Mode action.

XenMobile Analyze Manage Configure administrator

Devices Users Enrollment Invitations

Device details

- 1 General
- 2 Properties
- 3 User Properties
- 4 Assigned Policies
- 5 Apps
- 6 Actions
- 7 Delivery Groups
- 8 iOS Profiles
- 9 iOS Provisioning Profiles
- 10 Certificates
- 11 Connections
- 12 MDM Status

Device Shutdown	No device shutdown.
Device locate	No device locate .
Device Enable Tracking	No device enable tracking.
Device Disown	No device disown.
DEP Activation Lock	No DEP device activation lock.
Activation Lock Bypass	No device activation lock bypass.
Device Clear Restrictions	No Clear Restrictions.
Device App Wipe	No device App Wipe.
Device App Lock	No device App Lock.
Request AirPlay Mirroring	No request AirPlay mirroring.
Stop AirPlay Mirroring	No stop AirPlay mirroring.
Enable Lost Mode	No lost mode enabled.
Disable Lost Mode	No lost mode disabled.

Next >

- From **Manage > Devices**, on the **Properties** tab, verify the **MDM lost mode enabled** value.

The screenshot shows the XenMobile console interface. At the top, there are tabs for 'XenMobile', 'Analyze', 'Manage', and 'Configure'. The 'Manage' tab is active, and the 'Devices' sub-tab is selected. On the left, a sidebar lists 'Device details' with sub-items: 1 General, 2 Properties (highlighted), 3 User Properties, 4 Assigned Policies, 5 Apps, 6 Actions, 7 Delivery Groups, 8 iOS Profiles, 9 iOS Provisioning Profiles, 10 Certificates, 11 Connections, and 12 MDM Status. The main content area displays a table of device properties:

Activation lock enabled	No
Hardware encryption capabilities	Block and file levels encryption
Internal storage encrypted	No
Jailbroken/Rooted	No
MDM lost mode enabled	No
Passcode compliant	Yes
Passcode compliant with configuration	Yes
Passcode present	No
Supervised	No

Below the table, there are two expandable sections:

- Storage space** (Add): Available storage space (10.92 GB), Total storage space (12.28 GB).
- System information** (Add): Active iTunes account (Yes), Cloud backup enabled (No).

At the bottom right, there are 'Back' and 'Next >' buttons.

If you enable XenMobile Lost Mode on an iOS device, the XenMobile console also changes as follows:

- In **Configure > Actions**, the **Actions** list doesn't include these automated actions: **Revoke the device**, **Selectively wipe the device**, and **Completely wipe the device**.
- In **Manage > Devices**, the **Security Actions** list no longer includes the **Revoke** and **Selective Wipe** device actions. You can still use a security action to perform a **Full Wipe** action, as needed.

For iPads running iOS 7 and later: iOS appends the words "Lost iPad" to what you type in the **Message** in the **Security Actions** dialog box.

For iPhones running iOS 7 and later: If you leave the **Message** empty and provide a phone number, Apple shows the message "Call owner" on the device lock screen.

Shared devices

Jun 19, 2017

XenMobile lets you configure devices that multiple users can share. The shared devices feature lets, for example, clinicians in hospitals use any nearby device to access apps and data rather than having to carry around a specific device. You may also want shift workers in fields like law enforcement, retail, and manufacturing to share devices to reduce equipment costs.

Key Points About Shared Devices

MDM mode

- Available on both iOS and Android tablets and phones. Basic device enrollment program (DEP) enrollment is not supported for a XenMobile Enterprise shared device. You must use an authorized DEP to enroll a shared device in this mode.
- Client certificate authentication, Citrix PIN, Touch ID, User Entropy, and two-factor authentication are not supported.

MDM+MAM mode

- Available only on iOS and Android tablets.
- Supported on XenMobile 10.3.x and later.
- Only Active Directory username and password authentication is supported.
- Client certificate authentication, Worx PIN, Touch ID, User Entropy, and two-factor authentication are not supported.
- MAM-only mode is not supported. The devices must enroll in MDM.
- Only Secure Mail, Secure Web, and the ShareFile mobile app are supported. HDX apps are not supported.
- Active Directory users are the only supported users; local users and groups are not supported
- Re-enrollment is required for existing MDM-only shared devices to update to MDM+MAM mode.
- Users can share XenMobile apps and MDX-wrapped apps only; they cannot share native apps on the devices.
- Once downloaded during first-time enrollment, XenMobile Apps are not downloaded again each time a new user signs on to the device. The new user can pick up the device, sign on, and get going.
- On Android, to isolate each user's data for security purposes, the **Disallow rooted devices** policy in the XenMobile console should be **On**.

Prerequisites for Enrolling Shared Devices

Before you can enroll shared devices, you must do the following:

- Create a shared device enrollment user role. See [Configuring Roles with RBAC](#).
- Create a shared device user. See [To add, edit, or delete local users in XenMobile](#).
- Create a delivery group that contains the base policies, apps, and actions that you want to be applied to the shared device enrollment user. See [Managing Delivery Groups](#).

Pre-requisites for MDM+MAM Mode

1. Create an Active Directory group named something like **Shared Device Enrollers**.
2. Add to this group Active Directory users who will enroll shared devices . If you want a new account for this purpose,

create a new Active Directory user (for example, **sdenroll**) and add that user to the Active Directory group.

Shared Device Requirements

For the best user experience, including silent installation and removal of apps, Citrix recommends configuring shared devices on the following platforms:

- iOS 9 and 10
- Android M
- Android 5.x
- Android 4.4.x
- Android 4.0.x (MDM-only mode)

Configuring a Shared Device

Follow these steps to configure a shared device.

1. From the XenMobile console, click the gear in the upper-right corner. The Settings page appears.
2. Click **Role-Based Access Control**, then click **Add**. The **Add Role** screen is displayed.
3. Create a shared-device enrollment user role named **Shared Device Enrollment User** with **Shared devices enroller** permissions under **Authorized Access**. Be sure to expand **Devices** in **Console features** and then select **Selective Wipe device**. This setting ensures that the apps and policies provisioned through the shared devices enroller account are deleted through Secure Hub, when the device is un-enrolled.

For **Apply Permissions**, keep the default setting, **To all user groups**, or assign permissions to specific Active Directory user groups with the **To specific user groups**.

XenMobile Analyze Manage Configure admin

Settings > Role-Based Access Control > Add Role

Add Role

1 Role Info

2 Assignment

Role Info

RBAC name*

RBAC template Select a template

Authorized access

- Admin console access
- Self Help Portal access
- Shared devices enroller
- Remote Support access
- Public api access

Console features

- Dashboard
- Reporting
- Devices
 - Full Wipe device
 - Clear Restriction
 - Selective Wipe device
 - View locations
 - Lock device
 - Unlock device

Apply permissions

- To all user groups
- To specific user groups

Click **Next** to move to the **Assignment** screen. Assign the shared-device enrollment role you just created to the Active Directory group you created for shared device enrollment users in Step 1 under Pre-requisites. In the image below, **citrix.lab** is the Active Directory domain and **Shared Device Enrollers** is the Active Directory group.

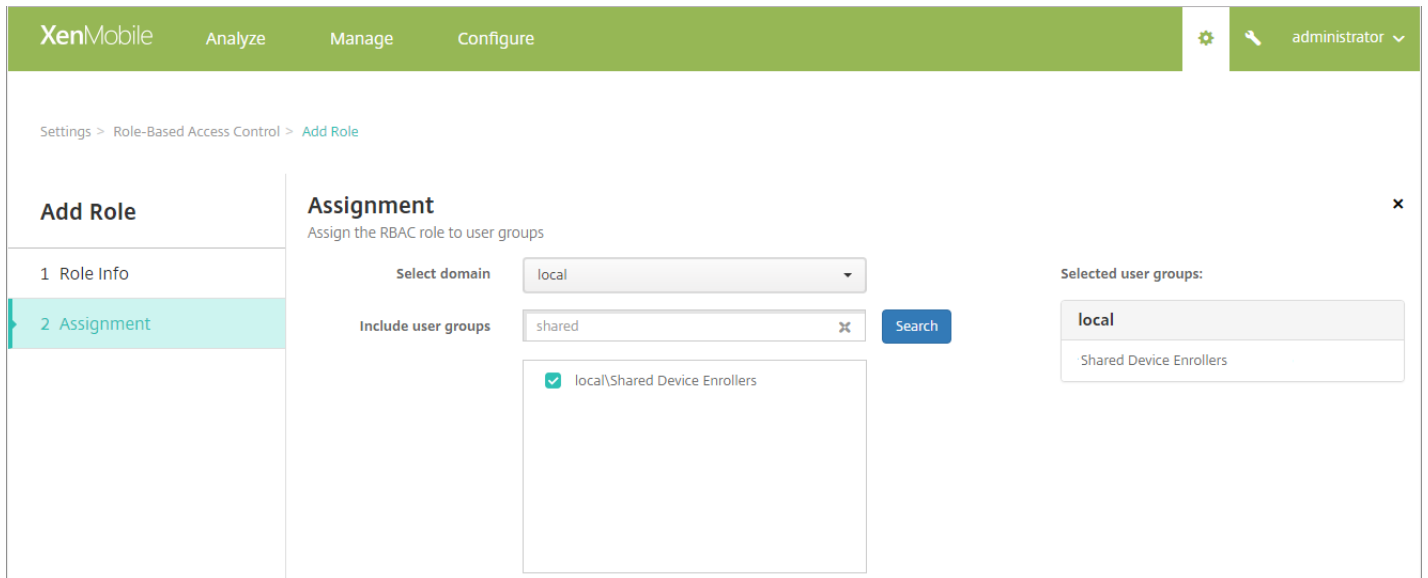

4. Create a delivery group that contains the base policies, apps, and actions that you want to apply to the device when a user is not signed on, then associate that delivery group with the shared device enrollment user Active Directory group.

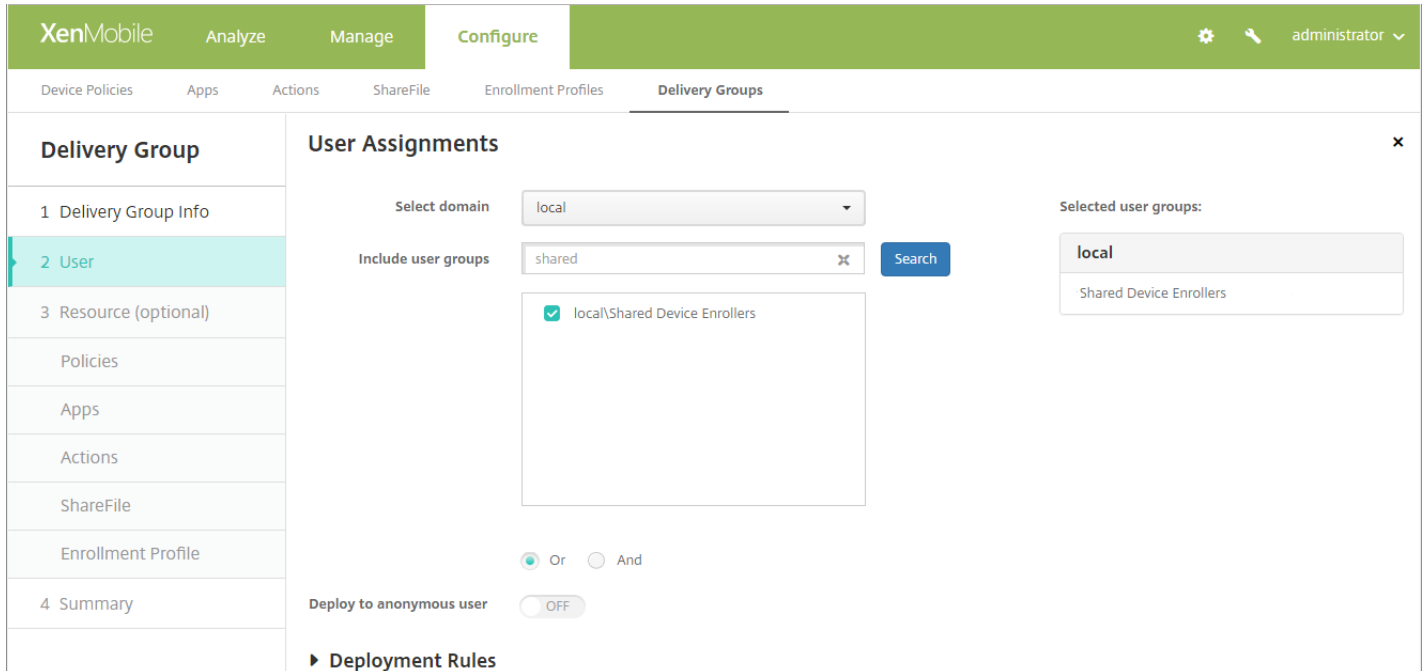

5. Install Secure Hub on the shared device and enroll it in XenMobile using the shared device enrollment user account. You can now view and manage the device through the XenMobile console. For more information, see [Enrolling Devices](#).

6. To apply different policies or to provide additional apps for authenticated users, you must create a delivery group

associated with those users and deployed to shared devices only. When creating the groups, configure deployment rules to ensure that the packages are deployed to shared devices. For more information, see [Configuring Deployment Rules](#).

7. To stop sharing the device, perform a selective wipe to remove the shared device enrollment user account from the device, along with any apps and policies deployed to it.

Shared Device User Experience

MDM mode

Users see only the resources available to them, and they have the same experience on every shared device. The shared device enrollment policies and apps always remain on the device. When a user who isn't enrolled in shared devices signs on to Secure Hub, that person's policies and apps are deployed to the device. When that user signs off, the policies and apps that differ from those of the shared device enrollment are removed, while the shared-device enrollment resources remain intact.

MDM+MAM mode

Secure Mail and Secure Web are deployed to the device when enrolled by the shared device enrollment user. User data is maintained securely on the device. The data is not exposed to other users when they sign on to Secure Mail or Secure Web.

Only one user at a time can sign on to Secure Hub. The previous user must sign off before the next user can sign on. For security reasons, Secure Hub does not store user credentials on shared devices, so users must enter their credentials each time they sign on. To ensure that a new user cannot access resources intended for the previous user, Secure Hub does not allow new users to sign on while the policies, apps, and data associated with the previous user are being removed.

Shared device enrollment doesn't change the process for upgrading apps. You can push upgrades to shared-device users as always, and shared-device users can upgrade apps right on their devices.

Recommended Secure Mail policies

- For the best Secure Mail performance, set **Max sync period** based on the number of users that will share the device. Allowing unlimited sync is not recommended.

Number of users sharing device	Recommended max sync period
21 to 25	1 week or less
6 to 20	2 weeks or less
5 or fewer	1 month or less

- Block **Enable contact export** to avoid exposing a user's contacts to other users who share the device.

- On iOS, only the following settings can be set per user. All other settings will be common across users who share the device:

Notifications

Signature

Out of Office

Sync Mail Period

S/MIME

Check Spelling

XenMobile Autodiscovery Service

Jun 19, 2017

Autodiscovery is an important part of many XenMobile deployments. Autodiscovery simplifies the enrollment process for users. They can use their network user names and Active Directory passwords to enroll their devices, rather than having to also enter details about the XenMobile server. Users enter their user name in user principal name (UPN) format; for example, user@mycompany.com. The XenMobile AutoDiscovery Service enables you to create or edit an autodiscovery record without assistance from Citrix support.

To access the XenMobile AutoDiscovery Service, navigate to <https://xenmobiletools.citrix.com> and the click **Request Auto Discovery**.

The screenshot displays the XenMobile Management Tools interface. At the top, there is a navigation bar with 'XenMobile' and 'Management Tools' on the left, and the Citrix XenMobile logo on the right. Below the navigation bar, the main content area is titled 'All Management Tools' and 'What do you want to do?'. A subtitle reads: 'XenMobile Management Tools can help you troubleshoot your XenMobile Server set up and enable key features in your XenMobile deployment.' Below this, there are four main action cards:

- Analyze and Troubleshoot my XenMobile environment**: XenMobile Analyzer. Follow steps to identify and triage potential issues with your deployment.
- Request Auto Discovery**: Auto Discovery Service. Request and Configure Auto Discovery for your domain's XenMobile Server.
- Request push notification certificate signature**: Create APNs Certificate. Submit a request to Citrix to sign an APNs certificate, which you then submit to Apple.
- Enable APNs-based push notifications for WorxMail for iOS**: Upload APNs Certificate. Enable push notifications by uploading APNs certificate from Apple.

At the bottom of the interface, there is a 'Contact Citrix Support' link.

Requesting AutoDiscovery

1. On the AutoDiscovery Service page, you need to first claim a domain. Click **Add Domain**.

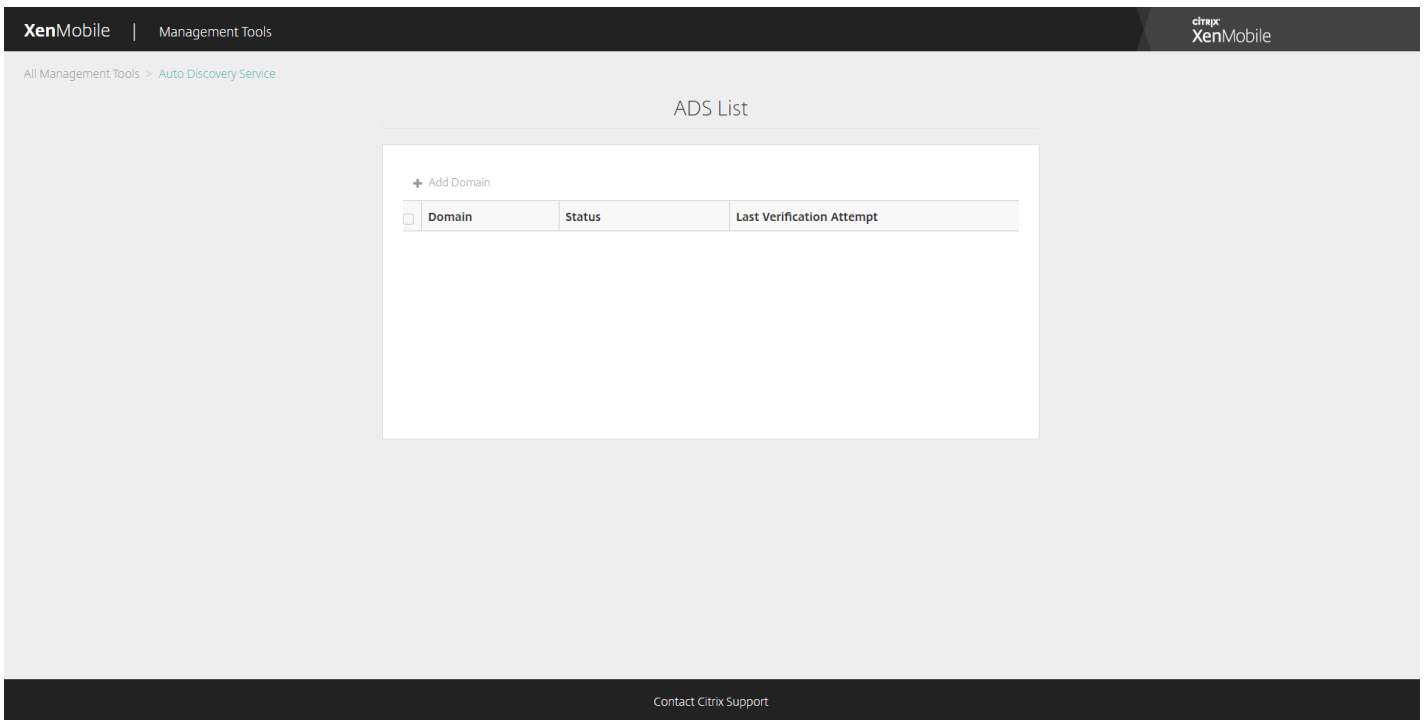

2. In the dialog box that opens, enter the domain name of your XenMobile environment and then click **Next**.

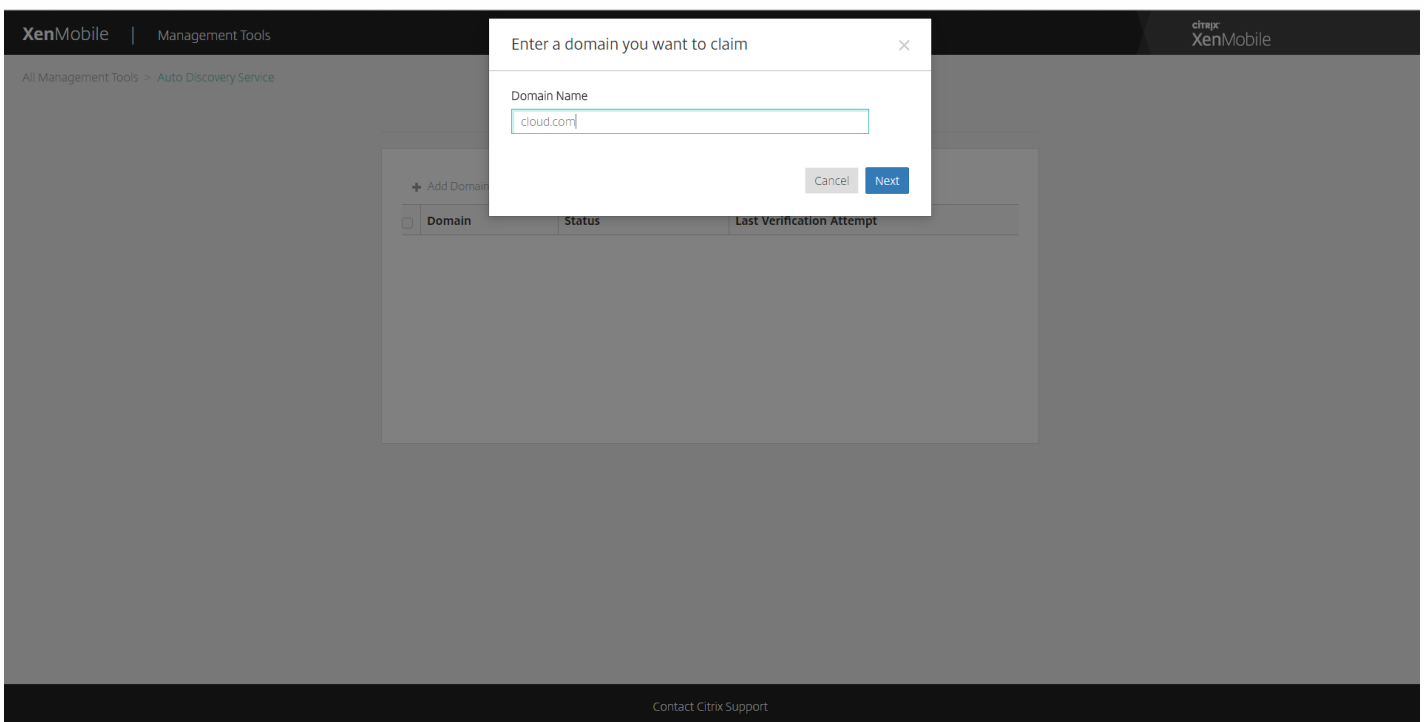

3. The next step provides instructions on verifying that you own the domain.
 - a. Copy the DNS token provided in the XenMobile Tools Portal.
 - b. Create a DNS TXT record in the zone file for your domain in your domain hosting provider portal.

To create a DNS TXT record you need to log into the Domain Hosting Provider portal for the domain you have added in step 2 above. In the Domain Hosting portal you can edit your Domain Name Server Records and add a custom TXT record. An example below of a adding a DNS TXT entry in a hosting portal for sample domain domain.com.

c. Paste the Domain Token in your DNS TXT record and save your Domain name Server record.

d. Back in the XenMobile Tools Portal, click Done, start DNS check.

The system detects your DNS TXT record. Alternatively, you can click I'll update later, and the record is saved. The DNS check won't start until you select the Waiting record and click DNS Check.

This check ideally takes about an hour, but it can take up to two days to return a response. In addition, you may need to leave the portal and return to see the status change.

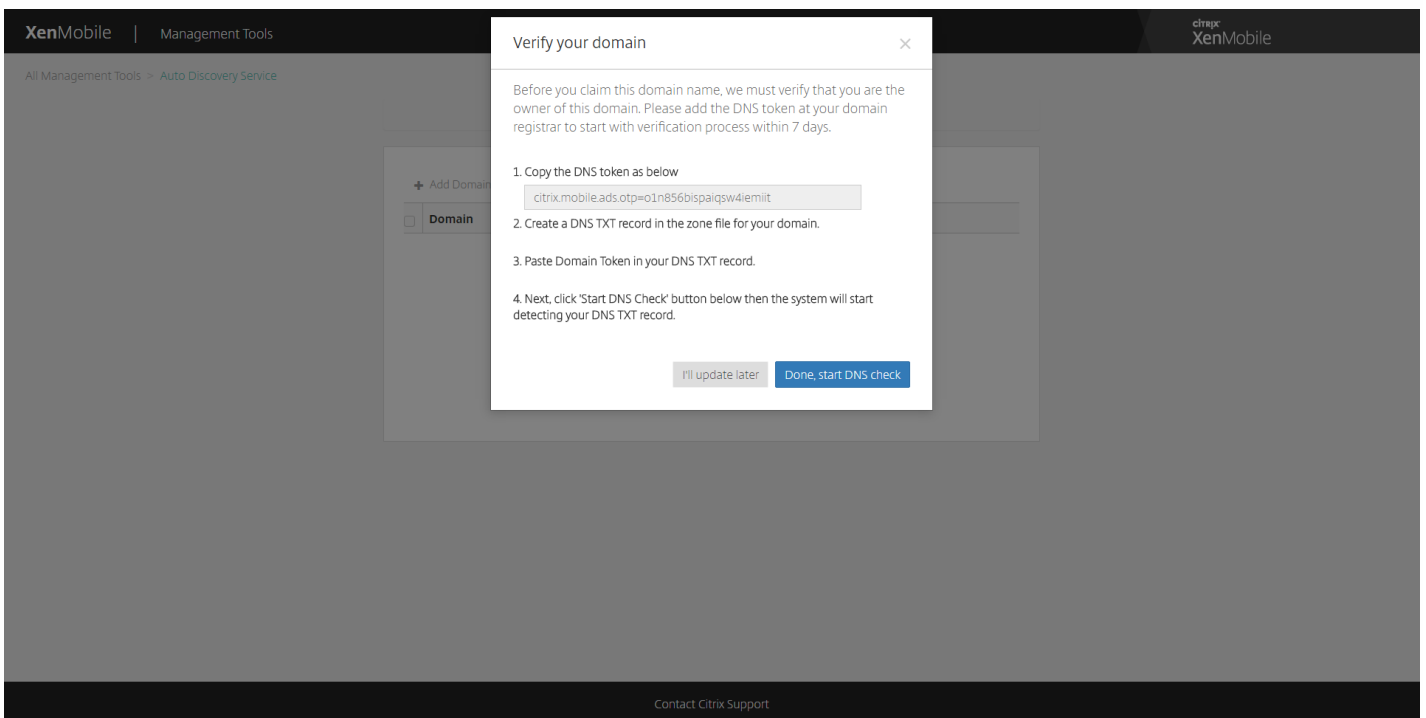

4. After you claim your domain, you can enter AutoDiscovery Service information. Right-click the domain record for which you want to request autodiscovery and then click **Add ADS**.

If your domain already has an AutoDiscovery record, please log a case with Citrix Technical Support to modify details as required.

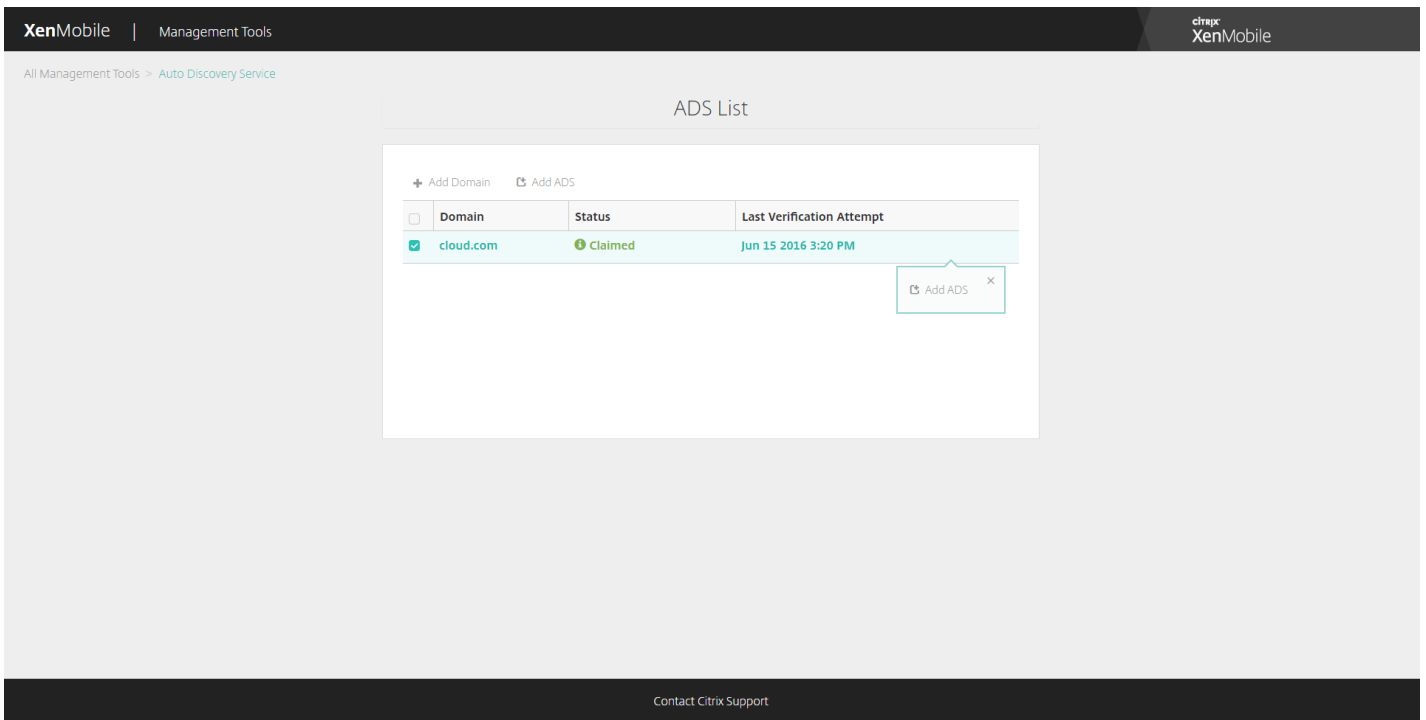

5. Enter your **XenMobile Server FQDN**, **NetScaler Gateway FQDN**, and **Instance Name** and then click **Next**. If you are unsure, add a default instance of "zdm".

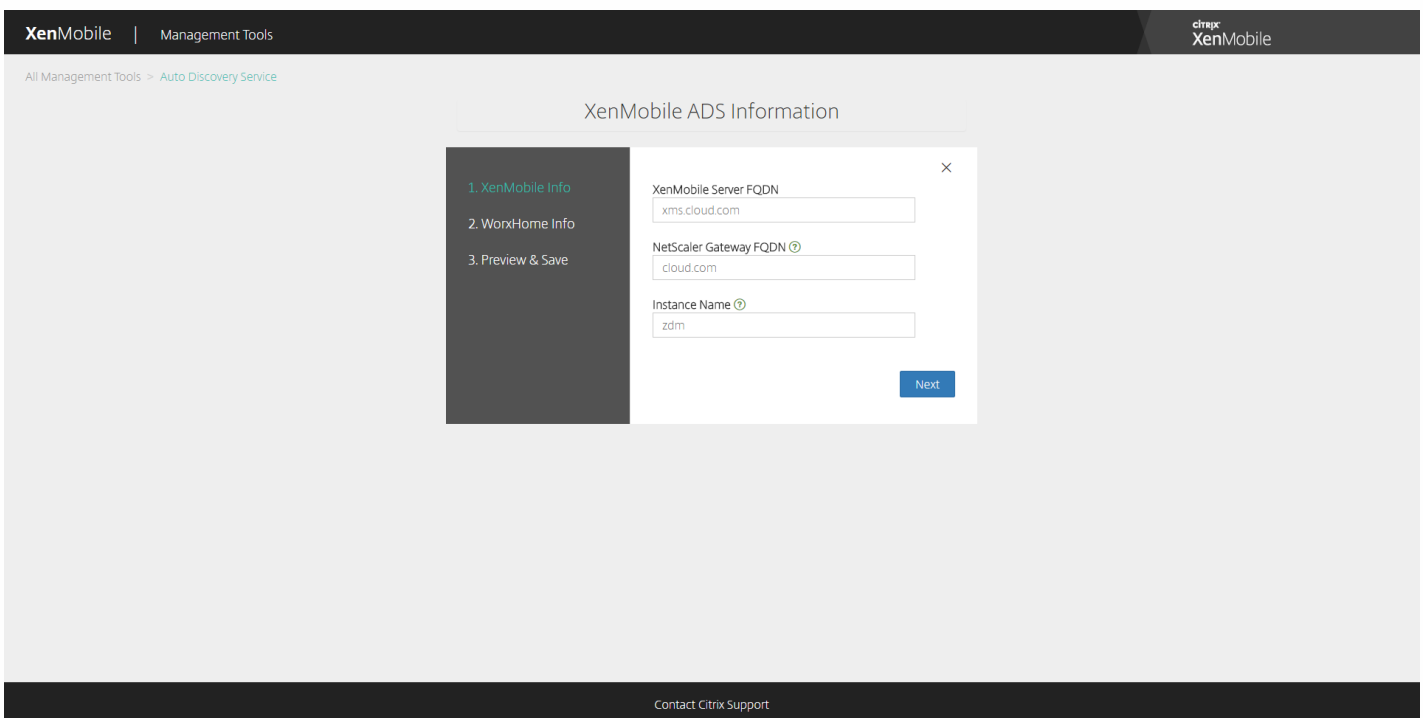

In the screenshot above, please note that Worx Home is now called Secure Hub.

6. Enter the following information for Secure Hub and then click **Next**.

a. **User ID Type**: Select the type of ID with which users sign on as either **E-mail address** or **UPN**.

UPN is used when the user's UPN (User Principal Name) is the same as their e-mail address. Both methods use the domain entered to find the server address. With **E-mail address** the user will be asked to enter their user name and password and with **UPN**, they will be asked to enter their password.

b. **HTTPS Port**: Enter the port used to access Secure Hub over HTTPS. Typically, this is port 443.

c. **iOS Enrollment Port**: Enter the port used to access Secure Hub for iOS enrollment. Typically, this is port 8443.

d. **Required Trusted CA for XenMobile**: Indicate whether a trusted certificate is required to access XenMobile or not. This option can be **OFF** or **ON**. Currently, the ability to upload a certificate for this feature does not exist. If you want to use this feature, you need to call Citrix Support, and have autodiscovery set up through them. To learn more about certificate pinning, see the section on certificate pinning in [Secure Hub](#) in the XenMobile Apps documentation. To read about the ports required for certificate pinning to work, see the support article on [XenMobile Port Requirements for ADS Connectivity](#).

The screenshot displays the 'WorxHome ADS Information' configuration window within the XenMobile Management Tools. The window is titled 'WorxHome ADS Information' and has a close button (X) in the top right corner. On the left side, there is a dark sidebar with three menu items: '1. XenMobile Info', '2. WorxHome Info' (which is highlighted in green), and '3. Preview & Save'. The main content area of the window contains the following configuration options:

- User ID Type**: A dropdown menu currently showing 'E-mail address'.
- HTTPS Port**: A text input field containing the value '443'.
- iOS Enrollment Port**: A text input field containing the value '8443'.
- Required Trusted CA for XenMobile**: A radio button control currently set to 'OFF'.

At the bottom right of the form, there are two buttons: a grey 'Back' button and a blue 'Next' button. The overall interface is clean and professional, with a dark header and footer. The header includes the 'XenMobile | Management Tools' branding, and the footer includes a 'Contact Citrix Support' link.

In the screenshot above, please note that Worx Home is now called Secure Hub.

7. A summary page displays all the information you entered in the preceding steps. Verify that the data is correct then click **Save**.

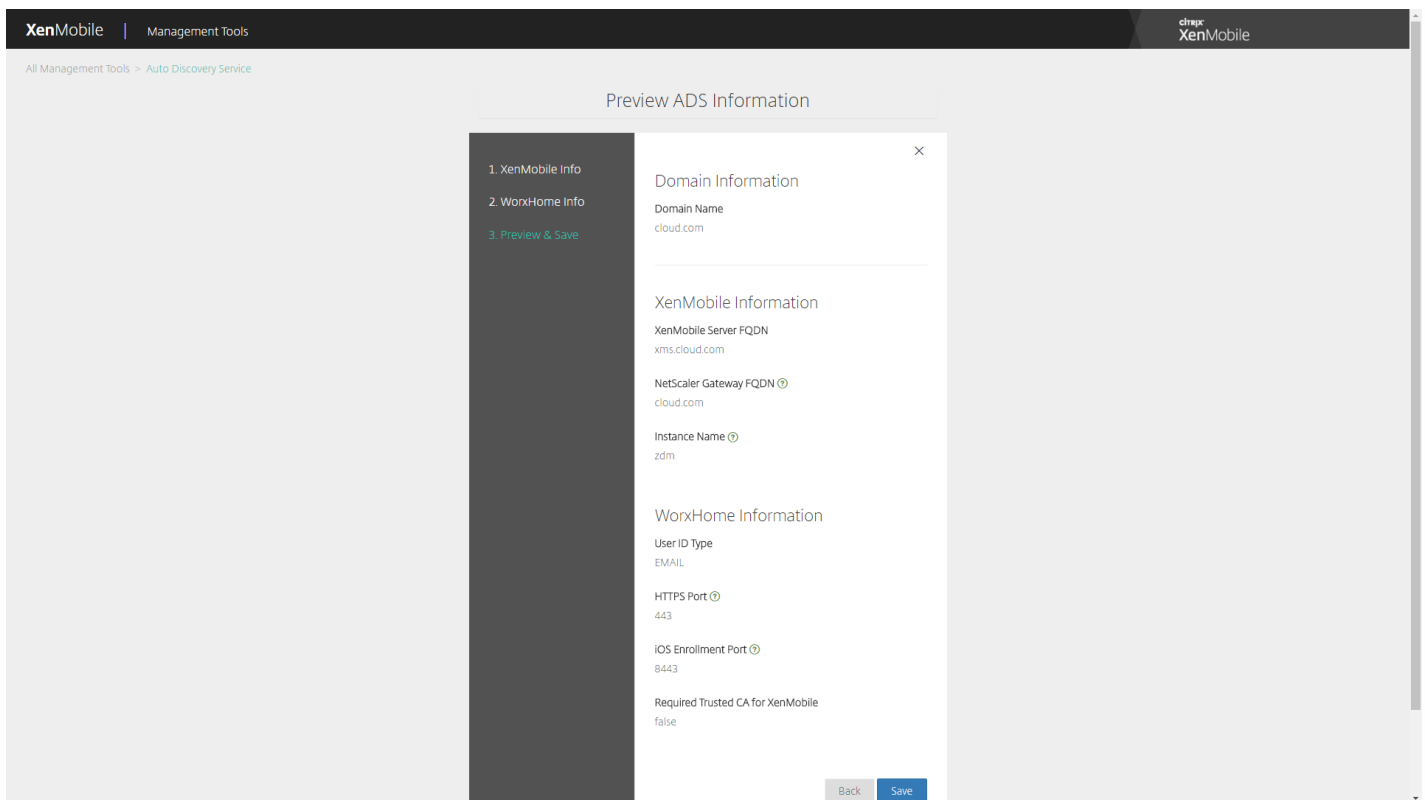

In the screenshot above, please note that Worx Home is now called Secure Hub.

Enable autodiscovery

Autodiscovery simplifies the enrollment process for users. They can use their network user names and Active Directory passwords to enroll their devices, rather than having to also enter details about the XenMobile server. Users enter their user name in user principal name (UPN) format; for example, user@mycompany.com.

To enable autodiscovery, you can access the Autodiscovery Service portal at <https://xenmobiletools.citrix.com>.

There may be some limited cases in which you need to contact Citrix Support to enable autodiscovery. To do so you can follow the procedures below to communicate your deployment information and, in the case of Windows devices, an SSL certificate to the Citrix Technical Support team. After Citrix receives this information, when users enroll their devices, the domain information is extracted and mapped to a server address. This information is maintained in the XenMobile database, so that the information is always accessible and available when users enroll.

1. If you are unable to enable autodiscovery using the Autodiscovery Service portal at <https://xenmobiletools.citrix.com>, open a Technical Support case using the [Citrix Support portal](#) and then provide the following information:

- The domain containing the accounts with which users will enroll.
- The XenMobile server fully qualified domain name (FQDN).
- The XenMobile instance name. By default, the instance name is zdm and is case-sensitive.
- User ID Type, which can be either UPN or Email. By default, the type is UPN.
- The port used for iOS enrollment if you changed the port number from the default port 8443.
- The port through which the XenMobile server accepts connections if you changed the port number from the default

port 443.

- Optionally, an email address for your XenMobile administrator.

2. If you plan to enroll Windows devices, do the following:

- Obtain a publicly signed, non-wildcard SSL certificate for `enterpriseenrollment.mycompany.com`, where `mycompany.com` is the domain containing the accounts with which users will enroll. Attach the SSL certificate in .pfx format and its password to your request.
- Create a canonical name (CNAME) record in your DNS and map the address of your SSL certificate (`enterpriseenrollment.mycompany.com`) to `autodisc.zc.zenprise.com`. When a Windows device user enrolls using a UPN, in addition to providing the details of your XenMobile server, the Citrix enrollment server instructs the device to request a valid certificate from the XenMobile server.

Your Technical Support case will be updated when your details and certificate, if applicable, have been added to the Citrix servers. At this point, users can start enrolling with autodiscovery.

Note: You can also use a multi-domain certificate if you want to enroll using more than one domain. The multi-domain certificate should have the following structure:

- A SubjectDN with a CN that specifies the primary domain it serves (for example, `enterpriseenrollment.mycompany1.com`).
- The appropriate SANs for the remaining domains (for example, `enterpriseenrollment.mycompany2.com`, `enterpriseenrollment.mycompany3.com`, and so on).

Device policies

Jul 20, 2017

You can configure how XenMobile interacts with your devices by creating policies. Although many policies are common to all devices, each device has a set of policies specific to its operating system. As a result, you might find differences between platforms, and even between different manufacturers of Android devices.

For the policies per platform matrix, download the [Device Policies by Platform Matrix PDF](#). For a summary description of each device policy, see [Device policy summaries](#) in this article.

Important

Before you create a policy, complete these requirements:

- Create any delivery groups you plan to use.
- Install any necessary CA certificates.

The basic steps to create a device policy are as follows:

1. Name and describe the policy.
2. Configure the policy for one or more platforms.
3. Create deployment rules (optional).
4. Assign the policy to delivery groups.
5. Configure the deployment schedule (optional).

To create and manage device policies, go to **Configure > Device Policies**.

XenMobile Analyze Manage **Configure** ⚙️ 🔍 admin ▾

Device Policies Apps Actions ShareFile Delivery Groups

Device Policies Show filter

🔍

➕ Add | 📄 Export

<input type="checkbox"/>	Policy name	Type	Created on	Last updated on	Status	▾
<input type="checkbox"/>	MBWifi	Wifi	10/26/15 1:03 PM	10/26/15 1:03 PM		
<input type="checkbox"/>	Passcode	Password	10/29/15 8:33 AM	10/29/15 8:33 AM		
<input type="checkbox"/>	Restrictions	Restrictions	10/29/15 8:34 AM	10/29/15 8:34 AM		
<input type="checkbox"/>	Personal Hotspot	Personal Hotspot	10/29/15 8:35 AM	10/29/15 8:35 AM		

Showing 1 - 4 of 4 items

Add a device policy

1. On the **Device Policies** page, click **Add**. The **Add a New Policy** page appears.

XenMobile Analyze Manage **Configure** ⚙️ 🔍 administrator ▾

Device Policies Apps Actions ShareFile Enrollment Profiles Delivery Groups

Policy Platform Clear All

- iOS 43
- Android 20
- Windows Mobile/CE 20
- Windows Phone 14
- Windows Desktop/Tablet 14
- Mac OS X 18
- Android HTC 1
- Android for Work 6
- Samsung SAFE 9
- Samsung KNOX 10
- Amazon 3

Add a New Policy Hide filter

🔍

Policies most often used	Apps	Security	End user
Exchange	App Access	Android for Work App Restrictions	AirPlay Mirroring
Location	App Attributes	App Lock	AirPrint
Passcode	App Configuration	App Restrictions	Calendar (CalDav)
Restrictions	App Inventory	Contacts (CardDAV)	Device Name
Scheduling	App Network Usage	Copy Apps to Samsung Container	Font
Terms & Conditions	App Uninstall	Credentials	Home Screen Layout
VPN	App Uninstall Restrictions	Defender	LDAP
WiFi	Browser	Kiosk	MDM Options
Network access	Delete Files and Folders	Managed Domains	Activate Windows Go to Settings to activate Windows. Mail

2. Click one or more platforms to view a list of the device policies for the selected platforms. Click a policy name to continue with adding the policy.

You can also type the name of the policy in the search box. As you type, potential matches appear. If your policy is in the list, click it. Only your selected policy remains in the results. Click it to open the **Policy Information** page for that policy.

3. Select the platforms you want to include in the policy. Configuration pages for the selected platforms appear in Step 5.

4. Complete the **Policy Information** page and then click **Next**. The **Policy Information** page collects information, such as the policy name, to help you identify and track your policies. This page is similar for all policies.

5. Complete the platform pages. Platform pages appear for each platform you selected in Step 3. These pages are different for each policy. A policy might differ among platforms. Not all policies apply to all platforms.

To configure deployment rules:

Note: For more information about configuring deployment rules, see [Deploy resources](#).

a. Expand **Deployment Rules** and then configure the following settings. The **Base** tab appears by default.

- In the lists, click options to determine when the policy should be deployed. You can choose to deploy the policy when all conditions are met or when any conditions are met. The default option is **All**.
- Click **New Rule** to define the conditions.
- In the lists, click the conditions, such as **Device ownership** and **BYOD**.
- Click **New Rule** again if you want to add more conditions. You can add as many conditions as you would like.

b. Click the **Advanced** tab to combine the rules with Boolean options. The conditions you chose on the **Base** tab appear.

c. You can use more advanced Boolean logic to combine, edit, or add rules.

- Click **AND, OR, or NOT**.
- In the lists, choose the conditions that you want to add to the rule. Then, click the Plus sign (+) on the right side to add the condition to the rule.

At any time, you can click to select a condition and then click **EDIT** to change the condition or **Delete** to remove the condition.

- Click **New Rule** to add another condition.

6. Click **Next** to move to the next platform page or, when all the platform pages are complete, to the **Assignments** page.

7. On the **Assignments** page, select the delivery groups to which you want to apply the policy. If you click a delivery group, the group appears in the **Delivery groups to receive app assignment** box.

Note: **Delivery groups to receive app assignment** doesn't appear until you select a delivery group.

Passcode Policy ✕

This policy creates a passcode policy based on the standards of your organization. You can require a code on the device and can set formatting rules and other passcode rules, such as the grace period before device lock.

Choose delivery groups

- AllUsers
- sales

Delivery groups to receive app assignment

AllUsers

8. On the **Assignments** page, expand **Deployment Schedule** and then configure the following settings:

- Next to **Deploy**, click **ON** to schedule deployment or click **OFF** to prevent deployment. The default option is **ON**.
- Next to **Deployment schedule**, click **Now** or **Later**. The default option is **Now**.
- If you click **Later**, click the calendar icon and then select the date and time for deployment.
- Next to **Deployment condition**, click **On every connection** or click **Only when previous deployment has failed**. The default option is **On every connection**.
- Next to **Deploy for always-on connection**, click **ON** or **OFF**. The default option is **OFF**.

Note:

- This option applies when you have configured the scheduling background deployment key in **Settings > Server Properties**. The always-on option is not available for iOS devices.
- The deployment schedule you configure is the same for all platforms. Any changes you make apply to all platforms, except for **Deploy for always on connection**, which does not apply to iOS.

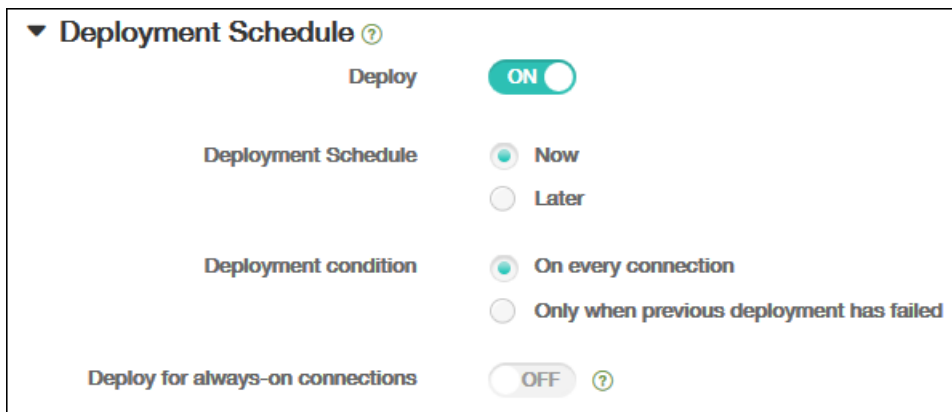

The screenshot shows the 'Deployment Schedule' settings panel. It includes a dropdown arrow and a help icon next to the title. The settings are as follows:

Setting	Value
Deploy	ON
Deployment Schedule	Now
Deployment condition	On every connection
Deploy for always-on connections	OFF

9. Click **Save**.

The policy appears in the **Device Policies** table.

Edit or delete a device policy

To edit or delete a policy, select the check box next to a policy to show the options menu above the policy list. Or, click a policy in the list to show the options menu to the right of the listing.

The screenshot shows the XenMobile interface with the 'Configure' tab selected. Under 'Device Policies', there are four policies listed: MBWifi, Passcode, Restrictions, and Personal Hotspot. The 'Passcode' policy is selected. A deployment summary dialog is open, showing the following data:

Policy name	Type	Created on	Last updated on	Status
MBWifi	Wifi	10/26/15 1:03 PM	10/26/15 1:03 PM	
Passcode	Password	10/29/15 8:33 AM	10/29/15 8:33 AM	
Restrictions	Restrictions			
Personal Hotspot	Personal Hotspot			

The deployment summary dialog shows:

- 0 Installed
- 0 Pending
- 0 Failed

A 'Show more >' link is visible at the bottom of the dialog.

To view policy details, click **Show more**.

To edit all settings for a device policy, click **Edit**.

If you click **Delete**, a confirmation dialog box appears. Click **Delete** again.

Filter the list of added device policies

You can filter the list of added policies by policy types, platforms, and associated delivery groups. On the **Configure > Device Policies** page, click **Show filter**. In the list, select the check boxes for the items you want to see.

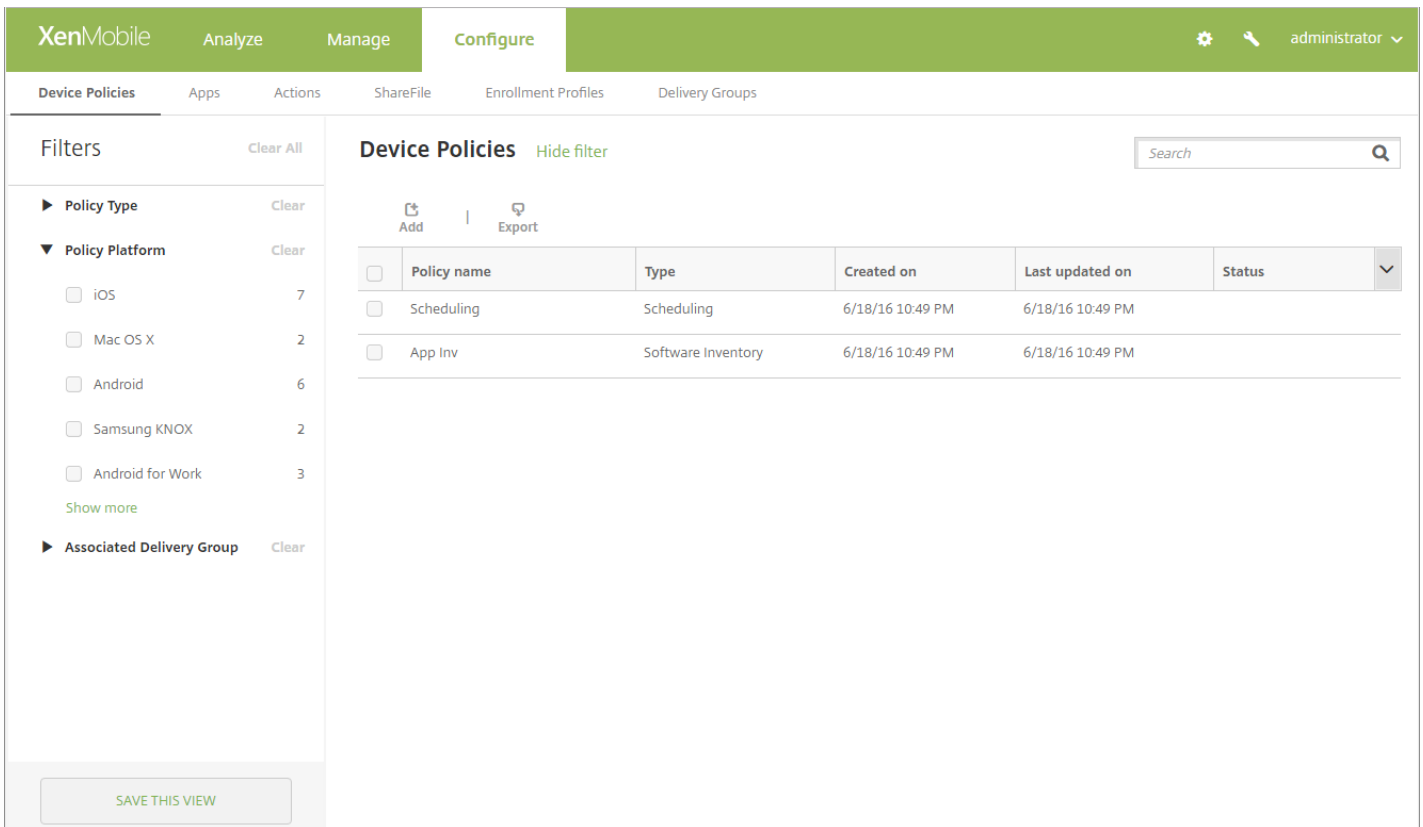

Click **SAVE THIS VIEW** to save a filter. The name of the filter then appears in a button below the **SAVE THIS VIEW** button.

Device policy summaries

Click **Lock**. The **Security Actions** confirmation dialog box displays.

Device Policy Name	Device Policy Description
AirPlay Mirroring	This policy adds specific AirPlay devices (such as Apple TV or another Mac computer) to iOS devices. You also have the option of adding devices to a whitelist for supervised devices, which limits users to only the AirPlay devices on the whitelist.
AirPrint	This policy allows you to add AirPrint printers to the AirPrint printer list on iOS devices. This policy makes it easier to support environments where the printers and the devices are on different subnets. Available for iOS 7.0 and later. Note: Be sure to have the IP address and resource path for each printer.
Android for Work App Restrictions	This policy allows you to change the restrictions associated with Android apps, but before you can do so, you must meet the following prerequisites:

	<ul style="list-style-type: none"> • Complete Android setup tasks on Google. For details, see Android at Work. • Add Android apps to XenMobile. For details, see Add a public app store app.
APN	You use this policy if your organization doesn't use a consumer APN to connect to the internet from a mobile device. This policy determines the settings used to connect your devices to the General Packet Radio Service (GPRS) of a specific phone carrier. This setting is already defined in most newer phones.
App Access	<p>This policy allows you to define a list of the following apps:</p> <ul style="list-style-type: none"> • Apps that are required to be installed on the device • Or, apps that can be installed on the device • Or, apps that must not be installed on the device. <p>You can then create an automated action to react to the device compliance with that list of apps.</p>
App Attributes	This policy lets you specify attributes, such as a managed app bundle ID or per-app VPN identifier, for iOS devices.
App Configuration	This policy lets you remotely configure various settings and behaviors of apps that support managed configuration. To do that, you deploy an XML configuration file (called a property list, or plist) to iOS devices. Or, you deploy key/value pairs to Windows 10 phone, desktop, or tablet devices.
App Inventory	This policy lets you collect an inventory of the apps on managed devices. XenMobile then compares the inventory to any app access policies deployed to those devices. In this way, you can detect apps that are on an app access blacklist or whitelist and then act accordingly.
App Lock	<p>This policy defines a list of apps that users either can run on a device or can't run on a device.</p> <p>You can configure this policy for both iOS and Android devices, but the way the policy works differs for each platform. For example, you cannot block multiple apps on an iOS device</p> <p>The App Lock policy works on most Android L and M devices. However, the App Lock policy doesn't work on Android N or later devices because Google deprecated the required API.</p> <p>For iOS devices, you can choose only one iOS app per policy. As a result, users can use their device to run a single app only. Users can't do any other activities on the device except for the options you specifically allow when the App Lock policy is enforced.</p>
App Network Usage	<p>This policy sets network usage rules to specify how managed apps use networks, such as cellular data networks, on iOS devices. The rules only apply to managed apps. Managed apps are apps that you deploy to user devices through XenMobile. Managed apps don't include these apps:</p> <ul style="list-style-type: none"> • Apps that users download directly to their devices. That is, the apps aren't deployed through XenMobile.

	<ul style="list-style-type: none"> • Apps already installed on the devices when the devices were enrolled in XenMobile.
App Restrictions	This policy creates blacklists for apps you want to prevent users from installing on Samsung KNOX devices. You can also create whitelists for apps you want to allow users to install.
App Uninstall	This policy lets you remove apps from user devices for several reasons. For example, you might not want to support certain apps. Or, your company might want to replace existing apps with similar apps from different vendors. The apps are removed when this policy is deployed to user devices. Except for Samsung KNOX devices, users receive a prompt to uninstall the app. Samsung KNOX device users do not receive a prompt to uninstall the app.
App Uninstall Restrictions	This policy lets you specify the apps that users can or can't uninstall.
Browser	This policy lets you define whether user devices can use the browser or which browser functions the devices can use. On Samsung devices, you can disable the browser, or you can enable or disable pop-ups, JavaScript, cookies, autofill, and whether to force fraud warnings.
Calendar (CalDav)	This policy adds a calendar (CalDAV) account to iOS or macOS devices. The CalDAV account enables users to synchronize scheduling data with any server that supports CalDAV.
Cellular	This policy allows you to configure cellular network settings
Connection Manager	.This policy specifies the connection settings for apps that connect automatically to the internet and to private networks. This policy is only available on Windows Pocket PCs.
Contacts (CardDAV)	This policy adds an iOS contact (CardDAV) account to iOS or macOS devices. The CardDAV account enables users to synchronize contact data with any server that supports CardDAV.
Control OS Updates	This policy lets you deploy the latest OS updates to supervised devices.
Copy apps to Samsung Container	This policy copies the apps already installed on a device to a SEAMS or KNOX container on supported Samsung devices. Apps copied to the SEAMS container are available on the device home screen. Apps copied to the KNOX container are available only when users sign in to the KNOX container.
Credentials	<p>This policy enables integrated authentication with your PKI configuration in XenMobile. For example, with a PKI entity, a keystore, a credential provider, or a server certificate. For information about credentials, see Certificates and authentication.</p> <p>Each device platform requires a different set of values, which are described in the Credentials policy article.</p>

Custom XML	<p>This policy customizes the following features:</p> <ul style="list-style-type: none"> • Provisioning, such as configuring the device, and enabling or disabling features • Device configuration, such as allowing users to change settings and device parameters • Software upgrades, such as providing new software or bug fixes for loading onto the device, including apps and system software • Fault management, such as receiving error and status reports from the device
Defender	This policy configures Windows Defender settings for Windows 10 for desktop and tablet.
Delete Files and Folders	This policy deletes specific files or folders from Windows Mobile/CE devices.
Delete Registry Keys and Values	This policy deletes specific registry keys and values from Windows Mobile/CE devices.
Device Health Attestation	<p>This policy requires that Windows 10 devices report the state of their health. To do that they send specific data and runtime information to the Health Attestation Service (HAS) for analysis. The HAS creates and returns a Health Attestation Certificate that the device then sends to XenMobile. When XenMobile receives the Health Attestation Certificate, based on the contents of that certificate, it can deploy automatic actions that you configured.</p> <p>For more information, see the Microsoft Device HealthAttestation CSP page.</p>
Device Name	This policy sets the names on iOS and macOS devices so that you can identify the devices. You can use macros, text, or a combination of both to define a device name. For information about macros, see Macros .
Enterprise Hub	<p>This policy for Windows Phone lets you distribute apps through the Enterprise Hub Company store.</p> <p>XenMobile supports only one Enterprise Hub policy for one mode of Windows Phone Secure Hub. For example, don't create multiple Enterprise Hub policies with different versions of Secure Home for XenMobile Enterprise Edition. You can deploy the initial Enterprise Hub policy only during device enrollment.</p>
Exchange	XenMobile provides two options to deliver email. You can use this MDM policy to enable ActiveSync email for the native email client on the device. Or, you can deliver ActiveSync email using the containerized Secure Mail app.
Files	This policy adds script files to XenMobile that perform certain functions for users. Or, you can add document files that you want Android device users to be able to access on their devices. When you add the file, you can also specify the directory in which you want the file to be stored on the device.

	For example, to send Android users a company document or .pdf file, you deploy the file to the device. Then, let users know where the file is located.
Font	This policy adds more fonts to iOS and macOS devices. Fonts must be TrueType (.TTF) or OpenType (.OTF) fonts. Font collections (.TTC or .OTC) are not supported. For iOS, this policy applies only to iOS 7.0 and later.
Home screen layout	This policy specifies the layout of apps and folders for the iOS Home screen on iOS 9.3 and later supervised devices.
Import iOS and macOS Profile	This policy imports device configuration XML files for iOS and macOS devices into XenMobile. The file contains device security policies and restrictions that you prepare by using the Apple Configurator. For more information about using the Apple Configurator to create a configuration file, see the Apple Configurator Help page.
Kiosk	This policy restricts app usage on Samsung SAFE devices. You can limit available apps to a specific app or apps. This policy is useful for corporate devices that are intended to run only a specific type or class of apps. This policy also lets you choose custom images for the device home screen and lock screen wallpapers for kiosk mode.
Launcher Configuration	This policy for Android devices specifies the following for Citrix Launcher: <ul style="list-style-type: none"> • The apps allowed • A custom logo image for the Citrix Launcher icon • A custom background image for Citrix Launcher • Password requirements to exit the launcher
LDAP	This policy for iOS devices provides information about an LDAP server to use, including any necessary account information such as the LDAP server host name. The policy also provides a set of LDAP search policies to use when querying the LDAP server.
Location	This policy lets you geo-locate devices on a map, assuming that the device has GPS enabled for Secure Hub. After deploying this policy to the device, you can send a locate command from the XenMobile Server. The device then responds with its location coordinates. XenMobile also supports geofencing and tracking policies.
Mail	This policy configures an email account on iOS or macOS devices.
Managed Domains	This policy defines managed domains that apply to email and the Safari browser. Managed domains help you protect corporate data by controlling which apps can open documents downloaded from domains using Safari. For iOS 8 and later supervised devices, you can specify URLs or subdomains to control how users can open documents, attachments, and downloads from the browser.

MDM Options	This policy manages Find My Phone and iPad Activation Lock on supervised iOS 7.0 and later phone devices. For the steps on putting an iOS device in supervised mode, see Bulk enrollment of iOS and macOS devices .
Organization Info	This policy specifies organization information for alert messages that XenMobile deploys to iOS devices. Available on iOS 7 and later.
Passcode	This policy allows you to enforce a PIN code or password on a managed device. You can set the complexity and timeouts for the passcode on the device.
Personal Hotspot	This policy allows users to connect to the internet when they are not in range of a WiFi network. Users connect through the cellular data connection on their iOS device, using personal hotspot functionality. Available on iOS 7.0 and later.
Profile Removal	This policy, when deployed, removes the app profile from iOS or macOS devices.
Provisioning Profile	This policy specifies an enterprise distribution provisioning profile to send to devices. When you develop and code sign an iOS enterprise app, you usually include a provisioning profile. Apple requires the profile for the app to run on an iOS device. If a provisioning profile is missing or has expired, the app crashes when a user taps to open it.
Provisioning Profile Removal	This policy removes iOS provisioning profiles. For information on provisioning profiles, see Provisioning Profile device policy .
Proxy	This policy specifies global HTTP proxy settings for devices running Windows Mobile/CE and iOS 6.0 or later. You can deploy only one global HTTP proxy policy per device.
Registry	The Windows Mobile/CE registry stores data about apps, drivers, user preferences, and configuration settings. This policy defines the registry keys and values that let you administer Windows Mobile/CE devices.
Remote Support	This policy gives you remote access to Samsung KNOX devices.
Restrictions	This policy provides hundreds of options to lock down and control features and functionality on managed devices. Examples of restriction options: Disable the camera or microphone, enforce roaming rules, and enforce access to third-party services, such as app stores.
Roaming	This policy configures whether to allow voice and data roaming on iOS and Windows Mobile/CE devices. If voice roaming is disabled, data roaming is automatically disabled. For iOS, this policy is available on iOS 5.0 and later devices.

Samsung SAFE Firewall	This policy lets you configure the firewall settings for Samsung devices. You provide the IP addresses, ports, and host names that you want to allow devices to access or that you want to block devices from accessing. You can also configure the proxy and proxy reroute settings.
Samsung MDM License Key	This policy specifies the built-in Samsung Enterprise License Management (ELM) key that you must deploy to a device before you can deploy SAFE policies and restrictions. XenMobile supports and extends both Samsung for Enterprise (SAFE) and Samsung KNOX policies.
Scheduling	This policy is required for Android and Windows Mobile devices to connect back in to the XenMobile Server for MDM management, app push, and policy deployment. If you don't send this policy to devices and don't enable Google FCM, a device can't connect back to the server.
SCEP	This policy configures iOS and macOS devices to retrieve a certificate from an external SCEP server. You can also deliver a certificate to the device using SCEP from a PKI that is connected to XenMobile. To do that, create a PKI entity and a PKI provider in distributed mode. For details, see PKI entities .
SSO Account	This policy creates single sign-on (SSO) accounts so users sign on one-time only to access XenMobile and your internal company resources. Users do not need to store any credentials on the device. The SSO account enterprise user credentials are used across apps, including apps from the App Store. This policy is compatible with Kerberos authentication. Available for iOS 7.0 and later.
Storage Encryption	This policy encrypts internal and external storage. For some devices, this policy prevents users from using a storage card on their devices.
Subscribed Calendars	This policy adds a subscribed calendar to the calendars list on iOS devices. The list of public calendars to which you can subscribe is available at www.apple.com/downloads/macosx/calendars . Ensure that you subscribe to a calendar before you add it to the subscribed calendars list on user devices.
Terms and Conditions	This policy requires that users accept the specific policies of your company that govern connections to the corporate network. When users enroll their devices with XenMobile, they are presented with the terms and conditions and must accept them to enroll their devices. Declining the terms and conditions cancels the enrollment process.
Tunnel	This policy increases service continuity and data transfer reliability for your mobile apps. App tunnels define proxy parameters between the client component of any mobile device app and the app server component. You can also use app tunnels to create remote support tunnels to a device for management support. Note: Any app traffic sent through a tunnel that you define in this policy goes through XenMobile first. Then the traffic is redirected to the server running the app.

VPN	This policy provides access to back end systems that use legacy VPN Gateway technology. This policy provides VPN gateway connection details that you can deploy to devices. XenMobile supports several VPN providers, including Cisco AnyConnect, Juniper, and Citrix VPN. If your VPN gateway supports this option, you can link this policy to a CA and enable VPN on-demand.
Wallpaper	This policy adds a .png or .jpg file to set wallpaper on an iOS device lock screen, home screen, or both. Available for iOS 7.1.2 and later. To use different wallpaper on iPads and iPhones, create different wallpaper policies and deploy them to the appropriate users.
Web Content Filter	This policy filters web content on iOS devices. XenMobile uses the Apple auto-filter function and the sites that you add to whitelists and blacklists. Available only for iOS 7.0 and later supervised devices. For information about placing an iOS device in Supervised mode, see Place an iOS device in Supervised mode by using the Apple Configurator .
Webclip	This policy places shortcuts, or webclips, to websites so that they appear alongside apps on user devices. You can specify your own icons to represent the webclips for iOS, macOS, and Android devices. Windows tablet only requires a label and a URL.
WiFi	This policy allows administrators to deploy WiFi router details to managed devices. The router details include SSID, authentication data, and configuration data.
Windows CE Certificate	This policy creates and delivers Windows Mobile/CE certificates from an external PKI to user devices. For more information about certificates and PKI entities, see Certificates and authentication .
Windows Information Protection	This policy specifies the apps which require Windows Information Protection at the enforcement level you set for the policy. The policy is for Windows 10 version 1607 and later supervised devices.
XenMobile Store	This policy specifies whether a XenMobile Store webclip appears on the home screen of user devices.
XenMobile Options	This policy configures the Secure Hub behavior when connecting to XenMobile from Android and Windows Mobile/CE devices.
XenMobile Uninstall	This policy uninstalls XenMobile from Android and Windows Mobile/CE devices. When deployed, this policy removes XenMobile from all devices in the deployment group.

Device policies by platform

Jun 19, 2017

To view the policies per platform, download the [Device Policies by Platform Matrix PDF](#). You add and configure the device policies in the XenMobile console from **Configure > Device Policies**.

The latest release of XenMobile supports device policies for the following platforms:

- Amazon
- iOS
- macOS
- Android HTC
- Android TouchDown
- Android for Work
- Android
- Android Sony
- Android Zebra
- Samsung SAFE
- Samsung KNOX
- Samsung SEAMS
- Windows 10 Phone
- Windows 10 Desktop/Tablet
- Windows Phone 8.1
- Windows Mobile/CE

For details on supported devices in the latest release of XenMobile, see [Supported device platforms](#).

Note

If your environment is configured with Group Policy Objects (GPOs):

When you configure XenMobile device policies for Windows 10, keep the following rule in mind. If a policy on one or more enrolled Windows 10 devices conflicts, the policy aligned with the GPO takes precedence.

AirPlay mirroring device policy

Jun 19, 2017

The Apple AirPlay feature allows users to wirelessly stream content from an iOS device to a TV screen through Apple TV, or to mirror exactly what's on a device display to a TV screen or another Mac computer.

You can add a device policy in XenMobile to add specific AirPlay devices (such as Apple TV or another Mac computer) to users' iOS devices. You also have the option of adding devices to a whitelist for supervised devices, which limits users to only the AirPlay devices on the whitelist. For information about placing a device into Supervised mode, see [To place an iOS device in Supervised mode by using the Apple Configurator](#).

Note: Before proceeding, be sure to have the device IDs and any passwords for all the devices you want to add.

1. In the XenMobile console, click **Configure > Device Policies**. The **Device Policies** page appears.
2. Click **Add**. The **Add a New Policy** dialog box appears.
3. Expand **More** and then, under **End user**, click **AirPlay Mirroring**. The **AirPlay Mirroring Policy** page appears.
4. In the **Policy Information** pane, enter the following information:
 - **Policy Name**: Type a descriptive name for the policy.
 - **Description**: Optionally, type a description of the policy.
5. Click **Next**. The **Policy Platforms** page appears.
6. Under **Platforms**, select the platforms you want to add. If you are only configuring for one platform, clear the others.

When you finish configuring the settings for a platform, refer to Step 7 for how to set that platform's deployment rules.

Configure iOS settings

The screenshot shows the XenMobile configuration interface for an AirPlay Mirroring Policy. The top navigation bar includes 'XenMobile', 'Analyze', 'Manage', 'Configure', and 'admin'. Below the navigation bar, there are tabs for 'Device Policies', 'Apps', 'Actions', 'ShareFile', and 'Delivery Groups'. The left sidebar shows the 'AirPlay Mirroring Policy' with sub-sections: '1 Policy Info', '2 Platforms' (with 'iOS' and 'Mac OS X' selected), and '3 Assignment'. The main content area is titled 'Policy Information' and contains the following sections:

- AirPlay Password:** A table with columns for 'Device Name*' and 'Password*', and an 'Add' button.
- Whitelist ID:** A table with a column for 'Device ID*' and an 'Add' button.
- Policy Settings:** Includes a 'Remove policy' section with radio buttons for 'Select date' (selected) and 'Duration until removal (in days)', and a date picker. Below it is an 'Allow user to remove policy' dropdown menu set to 'Always'.
- Deployment Rules:** A section with a right-pointing arrow.

At the bottom right of the main area are 'Back' and 'Next >' buttons.

Configure these settings:

- **AirPlay Password:** For each device you want to add, click **Add** and then do the following:
 - **Device ID:** Enter the hardware address (Mac address) in xx:xx:xx:xx:xx:xx format. This field is not case-sensitive.
 - **Password:** Enter an optional password for the device.
 - Click **Add** to add the device or click **Cancel** to cancel adding the device.
- **Whitelist ID:** This list is ignored for unsupervised devices. The device IDs in this list are the only AirPlay devices available to users' devices. For each AirPlay device you want to add to the list, click **Add** and then do the following:
 - **Device ID:** Type the device ID in xx:xx:xx:xx:xx:xx format. This field is not case-sensitive.
 - Click **Add** to add the device or click **Cancel** to cancel adding the device.

Note: To delete an existing device, hover over the line containing the listing and click the trash can icon on the right-hand side. A confirmation dialog box appears. Click **Delete** to delete the listing or **Cancel** to keep the listing.

To edit an existing device, hover over the line containing the listing and click the pen icon on the right-hand side. Make any changes to the listing and then click **Save** to save the changed listing or **Cancel** to leave the listing unchanged.

- **Policy Settings**
 - Next to **Remove policy**, click either **Select date** or **Duration until removal (in hours)**.
 - If you click **Select date**, click the calendar to select the specific date for removal.
 - In the **Allow user to remove policy** list, click **Always**, **Password required**, or **Never**.
 - If you click **Password required**, next to **Removal password**, type the necessary password.

Configure Mac OSX settings

Configure these settings:

- **AirPlay Password:** For each device you want to add, click **Add** and then do the following:
 - **Device ID:** Enter the hardware address (Mac address) in xx:xx:xx:xx:xx:xx format. This field is not case-sensitive.
 - **Password:** Enter an optional password for the device.
 - Click **Add** to add the device or click **Cancel** to cancel adding the device.
- **Whitelist ID:** This list is ignored for unsupervised devices. The device IDs in this list are the only AirPlay devices available to users' devices. For each AirPlay device you want to add to the list, click **Add** and then do the following:
 - **Device ID:** Type the device ID in xx:xx:xx:xx:xx:xx format. This field is not case-sensitive.
 - Click **Add** to add the device or click **Cancel** to cancel adding the device.

Note: To delete an existing device, hover over the line containing the listing and click the trash can icon on the right-hand side. A confirmation dialog box appears. Click **Delete** to delete the listing or **Cancel** to keep the listing.

To edit an existing device, hover over the line containing the listing and click the pen icon on the right-hand side. Make any changes to the listing and then click **Save** to save the changed listing or **Cancel** to leave the listing unchanged.

- **Policy Settings**
 - Next to **Remove policy**, click either **Select date** or **Duration until removal (in hours)**.
 - If you click **Select date**, click the calendar to select the specific date for removal.
 - In the **Allow user to remove policy** list, click **Always**, **Password required**, or **Never**.
 - If you click **Password required**, next to **Removal password**, type the necessary password.
 - Next to **Profile scope**, click either **User** or **System**. The default is **User**.

7. Configure deployment rules and choose delivery groups. For more information, see [Add a device policy](#).

AirPrint device policy

Jun 19, 2017

You can add a device policy in XenMobile to add AirPrint printers to the AirPrint printer list on users' iOS devices. This policy makes it easier to support environments where the printers and the devices are on different subnets.

Note:

- This policy applies to iOS 7.0 and later.
- Be sure to have the IP address and resource path for each printer.

1. In the XenMobile console, click **Configure > Device Policies**. The **Device Policies** page appears.

2. Click **Add**. The **Add a New Policy** dialog box appears.

3. Click **More** and then, under **End user**, click **AirPrint**. The **AirPrint Policy** page appears.

4. In the **Policy Information** pane, enter the following information:

- **Policy Name:** Type a descriptive name for the policy.
- **Description:** Optionally, type a description of the policy.

5. Click **Next**. The **iOS Platform Information** page appears.

The screenshot shows the XenMobile console interface. The top navigation bar includes 'XenMobile', 'Analyze', 'Manage', and 'Configure'. The 'Configure' section is active, showing 'Device Policies', 'Apps', 'Actions', 'ShareFile', and 'Delivery Groups'. The 'AirPrint Policy' page is displayed, with a sidebar on the left containing '1 Policy Info', '2 Platforms', '3 Assignment', and 'iOS' (selected). The main content area is titled 'Policy Information' and contains a description: 'This policy lets you add AirPrint printers to the printer list on the users' iOS device. The policy is available for iOS 7 and later devices.' Below the description is the 'AirPrint Destination' section, which includes two input fields: 'IP Address*' and 'Resource Path*', followed by an 'Add' button. The 'Policy Settings' section includes a 'Remove policy' section with two radio buttons: 'Select date' (selected) and 'Duration until removal (in days)'. Below these is a date picker. The 'Allow user to remove policy' section has a dropdown menu set to 'Always'. At the bottom of the page, there is a 'Deployment Rules' section and two buttons: 'Back' and 'Next >'.

6. Configure these settings:

- **AirPrint Destination:** For each AirPrint destination you want to add, click **Add** and then do the following:
 - **IP Address:** Enter the AirPrint printer IP address.
 - **Resource Path:** Enter the Resource Path associated with the printer. This value corresponds to the parameter of the

_ipps.tcp Bonjour record. For example, printers/Canon_MG5300_series or printers/Xerox_Phaser_7600.

- Click **Save** to add the printer or click **Cancel** to cancel adding the printer.

Note: To delete an existing printer, hover over the line containing the listing and then click the trash can icon on the right-hand side. A confirmation dialog box appears. Click Delete to delete the listing or Cancel to keep the listing.

To edit an existing printer, hover over the line containing the listing and then click the pen icon on the right-hand side. Make any changes to the listing and then click Save to save the changed listing or Cancel to leave the listing unchanged.

- **Policy Settings**

- Under **Policy Settings**, next to **Remove policy**, click either **Select date** or **Duration until removal (in hours)**.
- If you click **Select date**, click the calendar to select the specific date for removal.
- In the **Allow user to remove policy** list, click **Always**, **Password required**, or **Never**.
- If you click **Password required**, next to **Removal password**, type the necessary password.

7. Configure deployment rules and choose delivery groups. For more information, see [Add a device policy](#).

Android for Work app restriction policy

Jun 19, 2017

You can modify the restrictions associated with Android for Work apps, but before you can do so, you must meet the following prerequisites:

- Complete Android for Work setup tasks on Google. For more information, see [Managing Devices with Android for Work](#).
- Create an Android for Work account. For more information, see [Create an Android for Work account](#).
- Add Android for Work apps to XenMobile. For more information, see [Adding Apps to XenMobile](#).

1. In the XenMobile console, click **Configure > Device Policies**. The **Device Policies** page appears.

2. Click **Add** to add a new policy. The **Add a New Policy** page appears.

3. Expand **More** and then under **Security**, click **Android for Work App Restrictions**. A dialog box appears asking you to select an app.

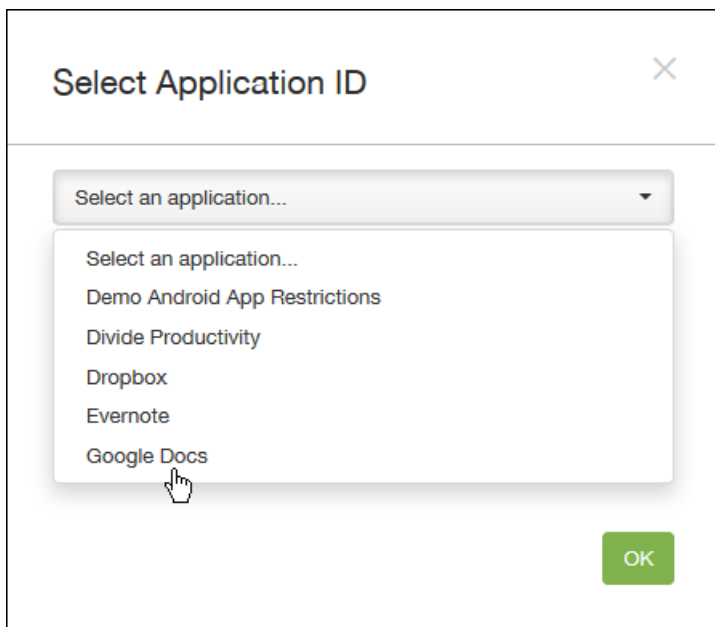

4. In the list, select the app to which you want to apply restrictions and then click **OK**.

- If there are no Android for Work apps added to XenMobile, you cannot proceed. For more information about adding apps to XenMobile, see [Adding Apps to XenMobile](#).
- If the app has no restrictions associated with it, a notification to that effect appears. Click **OK** to dismiss the dialog box.
- If the app has restrictions associated with it, the **Android for Work App Restrictions Policy** information page appears.

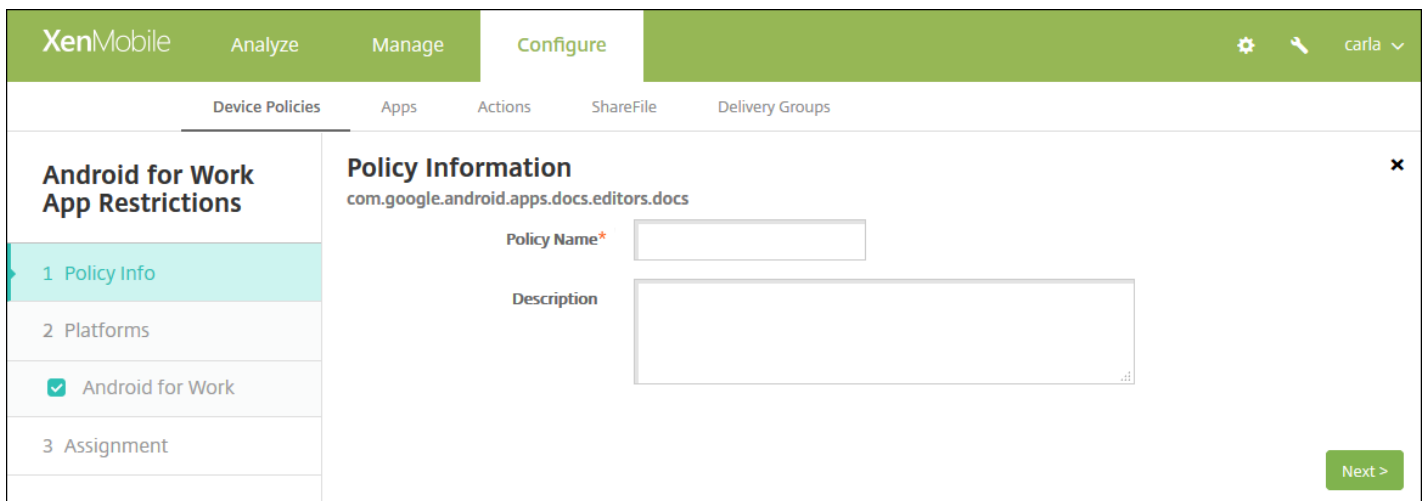

5. In the **Policy Information** pane, enter the following information:

- **Policy Name:** Type a descriptive name for the policy.
- **Description:** Optionally, type a description of the policy.

6. Click **Next**. The **Android for Work Platform** page appears.

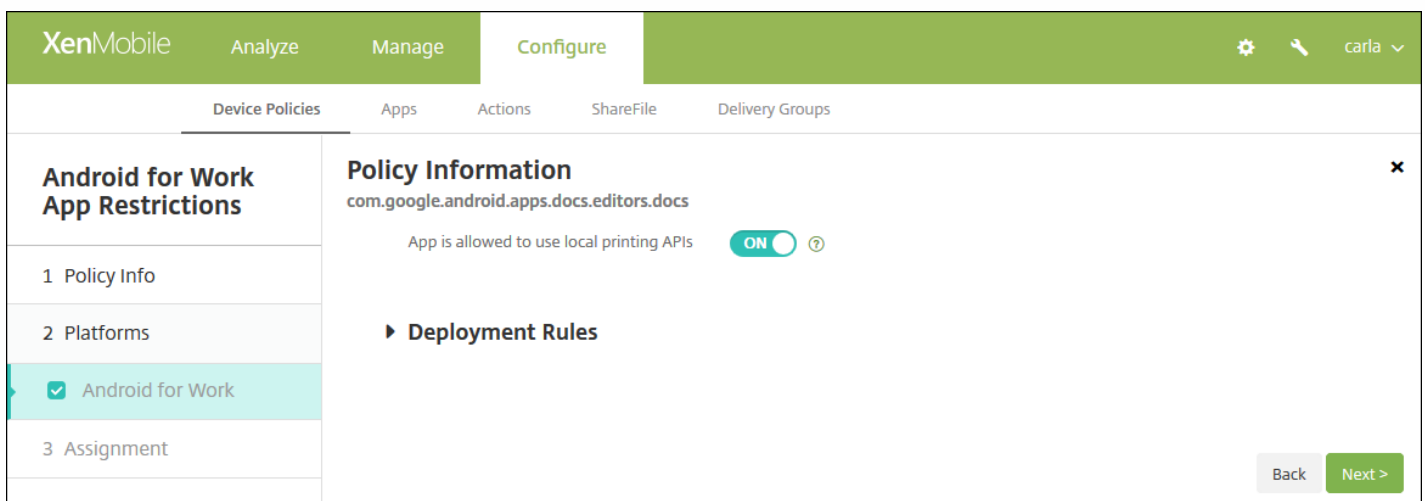

7. Configure the settings for the app you selected. The settings you see depend on the restrictions associated with the selected app.

7. Configure deployment rules and choose delivery groups. For more information, see [Add a device policy](#).

APN device policy

Jun 19, 2017

You can add a custom Access Point Name (APN) device policy for iOS, Android, and Windows Mobile/CE devices. You use this policy if your organization does not use a consumer APN to connect to the Internet from a mobile device. An APN policy determines the settings used to connect your devices to a specific phone carrier's General Packet Radio Service (GPRS). This setting is already defined in most newer phones.

[iOS settings](#)

[Android settings](#)

[Windows Mobile/CE settings](#)

1. In the XenMobile console, click **Configure > Device Policies**. The **Device Policies** page appears.
2. Click **Add**. The **Add a New Policy** dialog box appears.
3. Click **More**, and then under **Network Access**, click **APN**. The **APN Policy** information page appears.
4. In the **Policy Information** pane, enter the following information:
 - **Policy Name**: Type a descriptive name for the policy.
 - **Description**: Optionally, type a description of the policy.
5. Click **Next**. The **Policy Platforms** page appears.

Note: When the **Policy Platforms** page appears, all platforms are selected and you see the iOS platform first.

6. Under **Platforms**, select the platforms you want to add.

When you finish configuring the settings for a platform, refer to Step 7 for how to set that platform's deployment rules.

XenMobile Analyze Manage **Configure** admin

Device Policies Apps Actions ShareFile Delivery Groups

APN Policy

1 Policy Info

2 Platforms

- iOS
- Android
- Windows Mobile/CE

3 Assignment

Policy Information

This policy creates a custom Access Point Name (APN) on the device. Use this policy if your organization does not use a consumer APN to connect to the Internet from a mobile device.

APN*

User name

Password

Server proxy address

Server proxy port

Policy Settings

Remove policy Select date Duration until removal (in days)

Allow user to remove policy

► Deployment Rules

Back Next >

Configure these settings:

- **APN:** Type the name of the access point. This must match an accepted iOS APN or the policy will fail.
- **User name:** This string specifies the user name for this APN. If the user name is missing, the device prompts for the string during profile installation.
- **Password:** The password for the user for this APN. For obfuscation purposes, the password is encoded. If it is missing from the payload, the device prompts for the password during profile installation.
- **Server proxy address:** The IP address or URL of the APN proxy.
- **Server proxy port:** The port number for the APN proxy. This is required if you entered a server proxy address.
- Under **Policy Settings**, next to **Remove policy**, click either **Select date** or **Duration until removal (in hours)**.
 - If you click **Select date**, click the calendar to select the specific date for removal.
 - In the **Allow user to remove policy** list, click **Always**, **Password required**, or **Never**.
 - If you click **Password required**, next to **Removal password**, type the necessary password.

XenMobile Analyze Manage **Configure** admin

Device Policies Apps Actions ShareFile Delivery Groups

APN Policy

1 Policy Info

2 Platforms

- iOS
- Android
- Windows Mobile/CE

3 Assignment

Policy Information

This policy creates a custom Access Point Name (APN) on the device. Use this policy if your organization does not use a consumer APN to connect to the Internet from a mobile device.

APN*

User name

Password

Server

APN type

Authentication type None

Server proxy address

Server proxy port

MMSC

Multimedia Messaging Server (MMS) proxy address

MMS port

► Deployment Rules

Back Next >

Configure these settings:

- **APN:** Type the name of the access point. This must match an accepted Android APN or the policy will fail.
- **User name:** This string specifies the user name for this APN. If the user name is missing, the device prompts for the string during profile installation.
- **Password:** The password for the user for this APN. For obfuscation purposes, the password is encoded. If it is missing from the payload, the device prompts for the password during profile installation.
- **Server:** This setting, which predates smart phones, is usually empty. It references a Wireless Application Protocol (WAP) gateway server for phones that could not access or render standard web sites.
- **APN type:** This setting must match the carrier's intended use for the access point. It is a comma separated string of APN service specifiers and must match the wireless carrier's published definitions. Examples include:
 - *. All traffic goes through this access point.
 - mms. Multimedia traffic goes through this access point.
 - default. All traffic, including multimedia, goes through this access point.
 - supl. Secure User Plane Location is associated with assisted GPS.
 - dun. Dial Up Networking is outdated and should rarely be used.
 - hipri. High priority networking.
 - fota. Firmware over the air is used for receiving firmware updates.
- **Authentication type:** In the list, click the type of authentication to be used. Defaults to None.
- **Server proxy address:** The IP address or URL of the carrier's APN HTTP proxy.

- **Server proxy port:** The port number for the APN proxy. This is required if you entered a server proxy address.
- **MMSC:** The MMS Gateway Server address provided by the carrier.
- **Multimedia Messaging Server (MMS) proxy address:** This is the multimedia messaging service server for MMS traffic. MMS succeeded SMS for sending larger messages with multimedia content, such as pictures or videos. These servers require specific protocols (such as MM1, ... MM11).
- **MMS port:** The port used for the MMS proxy.

The screenshot shows the XenMobile interface with the 'Configure' tab selected. The left sidebar shows 'APN Policy' with sections for '1 Policy Info', '2 Platforms', and '3 Assignment'. Under '2 Platforms', 'iOS', 'Android', and 'Windows Mobile/CE' are all checked. The main content area is titled 'Policy Information' and contains the following fields:

- APN*:** A text input field with a help icon.
- Network:** A dropdown menu currently set to 'Built-in office'.
- User name:** A text input field with a help icon.
- Password:** A text input field with a help icon.

Below these fields is a section for 'Deployment Rules' with a right-pointing arrow. At the bottom right of the form are 'Back' and 'Next >' buttons.

Configure the following settings:

- **APN:** Type the name of the access point. This must match an accepted Android APN or the policy will fail.
- **Network:** In the list, click the type of network to use. The default is **Built-in office**.
- **User name:** This string specifies the user name for this APN. If the user name is missing, the device prompts for the string during profile installation.
- **Password:** The password for the user for this APN. For obfuscation purposes, the password is encoded. If it is missing from the payload, the device prompts for the password during profile installation.

7. Configure deployment rules and choose delivery groups. For more information, see [Add a device policy](#).

App access device policy

Jun 19, 2017

The app access device policy in XenMobile allows you to define a list of apps that are either required to be installed on the device, can be installed on the device, or must not be installed on the device. You can then create an automated action to react to the device compliance with that list of apps. You can create app access policies for iOS, Android, and Windows Mobile/CE devices.

You can only configure one type of access policy at a time. You can add a policy for either a list of required apps, suggested apps, or forbidden apps, but not a mix within the same app access policy. If you create a policy for each type of list, it is recommended that you name each policy carefully, so you know which policy in XenMobile applies to which list of apps.

1. In the XenMobile console, click **Configure > Device Policies**.
2. Click **Add**. The **Add a New Policy** dialog box appears.
3. Expand **More**, and then under **Apps**, click **App Access**. The **App Access Policy** information page appears.
4. On the **Policy Information** pane, enter the following information:
 - **Policy Name**: Type a descriptive name for the policy.
 - **Description**: Type an optional description of the policy.
5. Click **Next**. The **Policy Platforms** page appears.

Under **Platforms**, select the platforms you want to add. If you are only configuring for one platform, clear the others.

When you finish configuring the settings for a platform, refer to Step 7 for how to set that platform's deployment rules.

6. Configure the following settings for each platform you select.
 - **Access policy**: Click Required, Suggested, or Forbidden. The default is Required.
 - To add one or more apps to the list, click **Add** and then do the following:
 - **App name**: Enter an app name.
 - **App Identifier**: Enter an optional app identifier.
 - Click **Save** or **Cancel**.
 - Repeat these steps for each app you want to add.

Note: To delete an existing app, hover over the line containing the listing and then click the trash can icon on the right-hand side. A confirmation dialog box appears. Click **Delete** to delete the listing or **Cancel** to keep the listing.

To edit an existing app, hover over the line containing the listing and then click the pen icon on the right-hand side. Make any changes to the listing and then click **Save** to save the changed listing or **Cancel** to leave the listing unchanged.

7. Configure deployment rules and choose delivery groups. For more information, see [Add a device policy](#).

App attributes device policy

Jun 19, 2017

The App attributes device policy lets you specify attributes, such as a managed app bundle ID or per-app VPN identifier, for iOS devices.

1. In the XenMobile console, click **Configure** > **Device Policies**. The **Device Policies** page appears.
2. Click **Add**. The **Add a New Policy** page appears.
3. Expand **More**, and then under **Apps**, click **App Attributes**. The **App Attributes Policy** information page appears.
4. In the **Policy Information** pane, enter the following information:
 - **Policy Name:** Type a descriptive name for the policy.
 - **Description:** Optionally, type a description of the policy.
5. Click **Next**. The **App Attributes** platform information page appears.

The screenshot shows the XenMobile console interface. At the top, there is a navigation bar with 'XenMobile', 'Analyze', 'Manage', 'Configure', and 'admin'. Below this is a sub-navigation bar with 'Device Policies', 'Apps', 'Actions', 'ShareFile', and 'Delivery Groups'. The main content area is titled 'App Attributes Policy' and contains a 'Policy Information' section. This section has a description: 'This policy lets you specify the attributes you want to add to apps on iOS devices.' Below the description are two dropdown menus: 'Managed app bundle ID*' with a 'Make a selection' dropdown, and 'Per-app VPN identifier' with a 'None' dropdown. Below these is a 'Deployment Rules' section. The left sidebar shows a navigation menu with '1 Policy Info', '2 Platforms', '3 Assignment', and 'iOS' selected. At the bottom right of the main content area, there are 'Back' and 'Next >' buttons.

6. Configure these settings:
 - **Managed app bundle ID:** In the list, click an app bundle ID or click **Add new**.
 - If you click **Add new**, type the app bundle ID in the field that appears.
 - **Per-app VPN identifier:** In the list, click per-app VPN identifier.
7. Configure deployment rules and choose delivery groups. For more information, see [Add a device policy](#).

App configuration device policy

Jun 28, 2017

You can remotely configure apps that support managed configuration by deploying an XML configuration file (called a property list, or plist) to users' iOS devices or key/value pairs for Windows 10 phone, tablet, or desktop devices. The configuration specifies various settings and behaviors in the app. XenMobile pushes the configuration to devices when the user installs the app. The actual settings and behaviors that you can configure depend on the app and are beyond the scope of this article.

1. In the XenMobile console, click **Configure > Device Policies**. The **Device Policies** page appears.
2. Click **Add**. The **Add a New Policy** page appears.
3. Expand **More**, and then under **Apps**, click **App Configuration**. The **App Configuration Policy** information page appears.
4. In the **Policy Information** pane, enter the following information:
 - **Policy Name**: Type a descriptive name for the policy.
 - **Description**: Optionally, type a description of the policy.
5. Click **Next**. The **Policy Platforms** page appears.

Under **Platforms**, select the platforms you want to add. If you are only configuring for one platform, clear the others.

When you finish configuring the settings for a platform, refer to Step 6 for how to set that platform's deployment rules.

- **Identifier**: In the list, click the app you want to configure or click **Add new** to add a new app to the list.
 - If you click **Add new**, type the app identifier in the field that appears.
- **Dictionary content**: Type, or copy and paste, the XML property list (plist) configuration information.
- Click **Check Dictionary**. XenMobile verifies the XML. If there are no errors, you see **Valid XML** below the content box. If any syntax errors appear below the content box, you must correct them before you can continue.

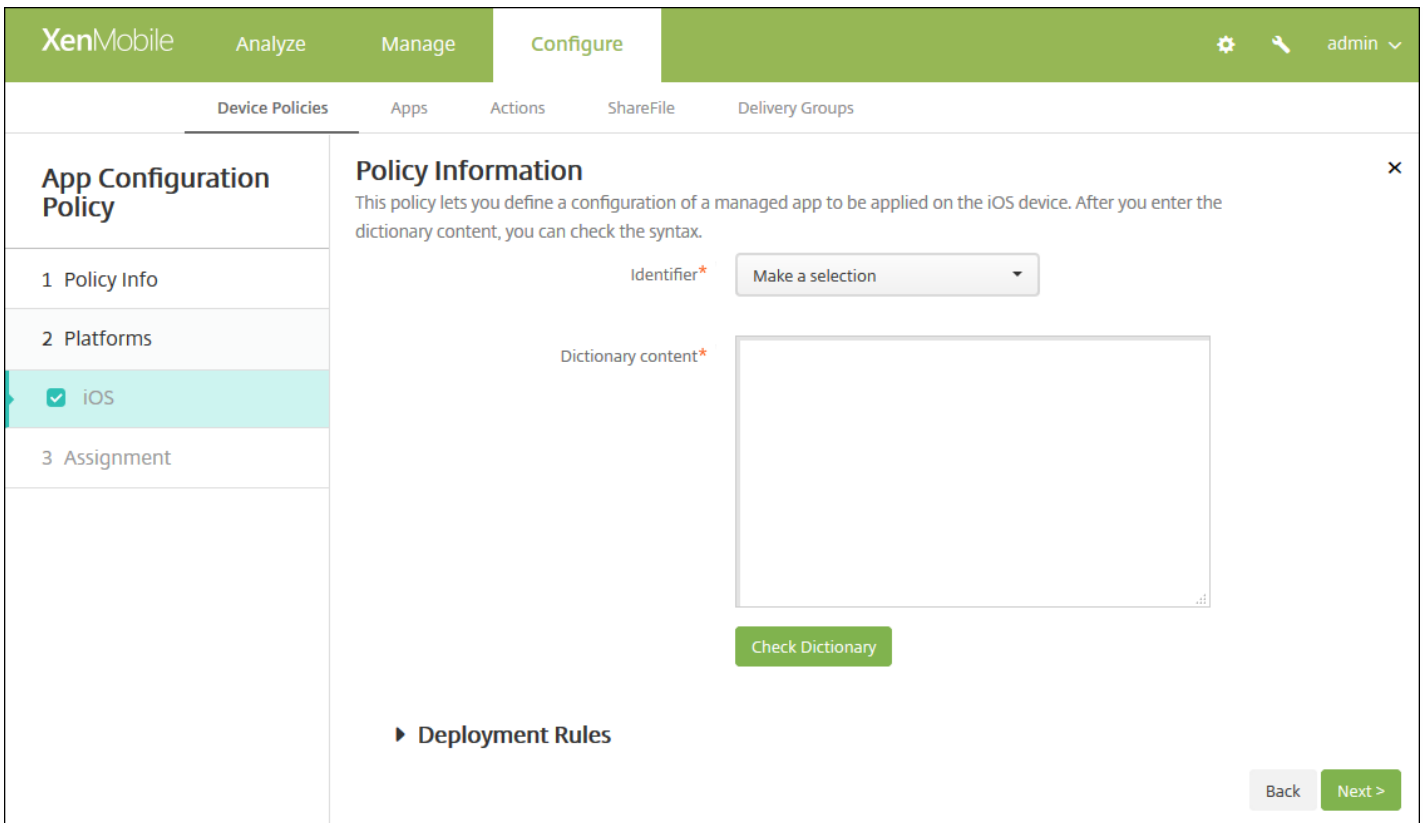

- In the **Make a selection** list, click the app you want to configure or click **Add new** to add a new app to the list.
 - If you click **Add new**, type the package family name in the field that appears.
- For each configuration parameter you want to add, click **Add** and then do the following:
 - **Parameter name**: Enter the key name of an application setting for the Windows device. For information about Windows app settings, refer to the Microsoft documentation.
 - **Value**: Enter the value for the specified parameter.
 - Click **Add** to add the parameter or click **Cancel** to cancel adding the parameter.

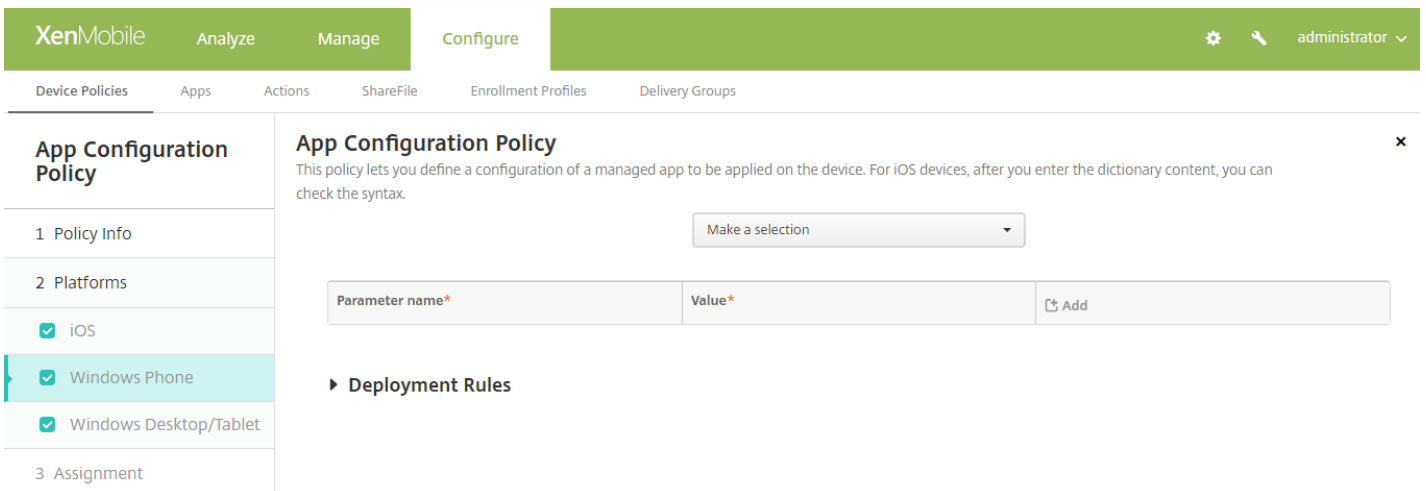

XenMobile Analyze Manage Configure administrator

Device Policies Apps Actions ShareFile Enrollment Profiles Delivery Groups

App Configuration Policy

This policy lets you define a configuration of a managed app to be applied on the device. For iOS devices, after you enter the dictionary content, you can check the syntax.

1 Policy Info

2 Platforms

- iOS
- Windows Phone
- Windows Desktop/Tablet

3 Assignment

Add new

Parameter name*	Value*	Add

► Deployment Rules

6. Configure deployment rules and choose delivery groups. For more information, see [Add a device policy](#).

App inventory device policy

Jun 19, 2017

An app inventory policy in XenMobile lets you collect an inventory of the apps on managed devices, and then the inventory is compared to any app access policies deployed to those devices. In this way, you can detect apps that appear on an app blacklist (forbidden in an app access policy) or whitelist (required in an app access policy) and take action accordingly. You can create app access policies for iOS, Mac OS X, Android (including for devices enabled for Android for Work), Windows desktop/tablet, Windows phone, or Windows Mobile/CE devices.

1. In the XenMobile console, click **Configure** > **Device Policies**. The **Device Policies** page appears.
2. Click **Add**. The **Add a New Policy** page appears.
3. Expand **More**, and under **Apps**, click **App Inventory**. The **App Inventory Policy** page appears.
4. In the **Policy Information** pane, type the following information:
 - **Policy Name:** Type a name for the policy.
 - **Description:** Type an optional description of the policy.
5. Click **Next**. The **Policy Platforms** page appears.

The screenshot shows the XenMobile console interface. The top navigation bar includes 'XenMobile', 'Analyze', 'Manage', and 'Configure'. Below this, there are tabs for 'Device Policies', 'Apps', 'Actions', 'ShareFile', and 'Delivery Groups'. The main content area is titled 'App Inventory Policy' and is divided into two panes. The left pane, 'App Inventory Policy', has three sections: '1 Policy Info', '2 Platforms', and '3 Assignment'. Under '2 Platforms', several options are listed with checkboxes: 'iOS', 'Mac OS X', 'Android', 'Windows Desktop/Tablet', 'Windows Phone', and 'Windows Mobile/CE'. The 'iOS' option is selected. The right pane, 'Policy Information', contains a description and a toggle switch for 'iOS' which is currently turned 'ON'. Below this is a section for 'Deployment Rules'. At the bottom right of the page, there are 'Back' and 'Next >' buttons.

Under **Platforms**, select the platforms you want to add. If you are only configuring for one platform, clear the others.

When you finish configuring the settings for a platform, refer to Step 7 for how to set that platform's deployment rules.

6. For each platform you select, leave the default setting or change the setting to **OFF**. The default is **ON**.

7. Configure deployment rules and choose delivery groups. For more information, see [Add a device policy](#).

App lock device policy

Jun 19, 2017

You can create a policy in XenMobile to define a list of apps that are allowed to run on a device, or a list of apps that are blocked from running on a device. You can configure this policy for both iOS and Android devices, but the exact way the policy works differs for each platform. For example, you cannot block multiple apps on an iOS device.

Likewise, for iOS devices, you can select only one iOS app per policy. This means that users are only able to use their device to run a single app. They cannot do any other activities on the device except for the options you specifically allow when the app lock policy is enforced.

In addition, iOS devices must be supervised to push App Lock policies.

Although the device policy works on most Android L and M devices, app lock does not function on Android N or later devices due to the deprecation of the required API by Google.

[iOS settings](#)

[Android settings](#)

1. In the XenMobile console, click **Configure** > **Device Policies**. The **Device Policies** page appears.
 2. Click **Add**. The **Add a New Policy** dialog box appears.
 3. Expand **More**, and then under **Security**, click **App Lock**. The **App Lock Policy** page appears.
 4. In the **Policy Information** pane, enter the following information:
 - **Policy Name**: Type a descriptive name for the policy.
 - **Description**: If desired, type a description of the policy.
 5. Click **Next**. The **Platforms** page appears.
 6. Under **Platforms**, select the platforms you want to add. If you are only configuring for one platform, clear the others.
- When you finish configuring the settings for a platform, refer to Step 7 for how to set that platform's deployment rules.

XenMobile Analyze Manage **Configure** ⚙️ 🔍 admin ▾

Device Policies Apps Actions ShareFile Delivery Groups

App Lock Policy

- 1 Policy Info
- 2 Platforms
 - iOS
 - Android
- 3 Assignment

Policy Information ✕

This policy lets you define a list of apps that are allowed to run on a device, or a list of apps that are blocked from running on a device.

App bundle ID*

Options

- Disable touch screen ON iOS 7.0+
- Disable device rotation sensing OFF iOS 7.0+
- Disable volume buttons OFF iOS 7.0+
- Disable ringer switch OFF iOS 7.0+
- Disable sleep/wake button OFF iOS 7.0+
- Disable auto lock OFF iOS 7.0+
- Enable VoiceOver OFF iOS 7.0+
- Enable zoom OFF iOS 7.0+
- Enable invert colors OFF iOS 7.0+
- Enable AssistiveTouch OFF iOS 7.0+
- Enable speak selection OFF iOS 7.0+
- Enable mono audio OFF iOS 7.0+

User Enabled Options

- Allow VoiceOver adjustment OFF iOS 7.0+
- Allow zoom adjustment OFF iOS 7.0+
- Allow invert colors adjustment OFF iOS 7.0+
- Allow AssistiveTouch adjustment OFF iOS 7.0+

Policy Settings

Remove policy Select date Duration until removal (in days)

Allow user to remove policy

▶ Deployment Rules

Configure these settings:

- **App bundle ID:** In the list, click the app to which this policy applies or click **Add new** to add a new app to the list. If you select **Add new**, type the app name in the field that appears.
- **Options:** Each of the following options applies only to iOS 7.0 or later. For each option, the default is **OFF** except for Disable touch screen, which defaults to **ON**.
 - Disable touch screen
 - Disable device rotation sensing
 - Disable volume buttons
 - Disable ringer switch - **Note:** When this option is disabled, the ringer behavior depends on what position the switch was in when it was first disabled.
 - Disable sleep/wake button
 - Disable auto lock
 - Disable VoiceOver
 - Enable zoom
 - Enable invert colors
 - Enable AssistiveTouch
 - Enable speak selection
 - Enable mono audio
- **User Enabled Options:** Each of the following options applies only to iOS 7.0 or later. For each option, the default is **OFF**.
 - Allow VoiceOver adjustment
 - Allow zoom adjustment
 - Allow invert colors adjustment
 - Allow AssitiveTouch adjustment
- **Policy Settings**
 - ○ Next to **Remove policy**, click either **Select date** or **Duration until removal (in hours)**.
 - ○ If you click **Select date**, click the calendar to select the specific date for removal.
 - ○ In the **Allow user to remove policy** list, click **Always**, **Password required**, or **Never**.
 - ○ If you click **Password required**, next to **Removal password**, type the necessary password.

App Lock Policy

1 Policy Info

2 Platforms

iOS

Android

3 Assignment

Policy Information

This policy lets you define a list of apps that are allowed to run on a device, or a list of apps that are blocked from running on a device.

App Lock parameters

Lock message

Unlock password

Prevent uninstall OFF

Lock screen

Enforce Blacklist Whitelist

Apps

App name*

► Deployment Rules

Configure these settings:

- **App Lock parameters**
 - **Lock message:** Type a message that users see when they attempt to open a locked app.
 - **Unlock password:** Type the password to unlock the app.
 - **Prevent uninstall:** Select whether users are allowed to uninstall apps. The default is **OFF**.
 - **Lock screen:** Select the image that appears on the device's lock screen by clicking **Browse** and navigating to the file's location.
 - **Enforce:** Click either **Blacklist** to create a list of apps that are not allowed to run on devices or click **Whitelist** to create a list of apps that are allowed to run on devices.
- **Apps:** Click **Add** and then do the following:
 - **App name:** In the list, click the name of the app to add to the whitelist or blacklist, or click **Add new** to add a new app to the list of available apps.
 - If you select **Add new**, type the app name in the field that appears.
 - Click **Save** or **Cancel**.
 - Repeat these steps each app you want to add to the whitelist or blacklist.

Note: To delete an existing app, hover over the line containing the listing and then click the trash can icon on the right-hand side. A confirmation dialog box appears. Click **Delete** to delete the listing or **Cancel** to keep the listing.

To edit an existing app, hover over the line containing the listing and then click the pen icon on the right-hand side. Make any changes to the listing and then click **Save** to save the changed listing or **Cancel** to leave the listing unchanged.

7. Configure deployment rules and choose delivery groups. For more information, see [Add a device policy](#).

App network usage device policy

Jun 19, 2017

You can set network usage rules to specify how managed apps use networks, such as cellular data networks, on iOS devices. The rules only apply to managed apps. Managed apps are those that you deploy to users' devices through XenMobile. They do not include apps that users have downloaded directly to their devices without being deployed through XenMobile or those already installed on the devices when the devices were enrolled in XenMobile.

1. In the XenMobile console, click **Configure > Device Policies**.
2. Click **Add**. The **Add a New Policy** dialog box appears.
3. Expand **More**, and then under **Apps**, click **App Network Usage**. The **App Network Usage Policy** information page appears.
4. On the **Policy Information** pane, enter the following information:
 - **Policy Name:** Type a descriptive name for the policy.
 - **Description:** Type an optional description of the policy.
5. Click **Next**. The **Policy Platforms** page appears.

The screenshot shows the XenMobile console interface. The top navigation bar includes 'XenMobile', 'Analyze', 'Manage', and 'Configure'. The 'Configure' section is active, showing 'Device Policies' as the selected category. The 'App Network Usage Policy' page is displayed, with a sidebar on the left containing a list of steps: '1 Policy Info', '2 Platforms', '3 Assignment', and 'iOS' (which is selected and highlighted in green). The main content area is titled 'Policy Information' and contains a description: 'This policy lets you set network usage rules to specify how managed apps use networks, such as cellular data networks. The rules only apply to managed apps.' Below this, there are two toggle switches: 'Allow roaming cellular data' (set to OFF) and 'Allow cellular data' (set to OFF). There is also a section for 'App Identifier Matches' with an 'App Identifier' input field and an 'Add' button. At the bottom right, there are 'Back' and 'Next >' buttons.

6. Configure these settings.

- **Allow roaming cellular data:** Select whether the specified apps can use a cellular data connection while roaming. The default is **OFF**.
- **Allow cellular data:** Select whether the specified apps can use a cellular data connection. The default is **OFF**.

- **App Identifier Matches:** For each app you want to add to the list, click **Add** and then do the following:
 - **App Identifier:** Enter an app identifier.
 - Click **Save** to save the app to the list or **Cancel** to not save the app to the list.

Note: To delete an existing app, hover over the line containing the listing and then click the trash can icon on the right-hand side. A confirmation dialog box appears. Click **Delete** to delete the listing or **Cancel** to keep the listing.

To edit an existing app, hover over the line containing the listing and then click the pen icon on the right-hand side. Make any changes to the listing and then click **Save** to save the changed listing or **Cancel** to leave the listing unchanged.

7. Configure deployment rules and choose delivery groups. For more information, see [Add a device policy](#).

App restrictions device policy

Jun 19, 2017

You can create blacklists for apps you want to prevent users from installing on Samsung KNOX devices, as well as whitelists for apps you want to allow users to install.

1. In the XenMobile console, click **Configure** > **Device Policies**. The **Device Policies** page appears.
2. Click **Add**. The **Add New Policy** dialog box appears.
3. Expand **More** and then, under **Security**, click **App Restrictions**. The **App Restrictions Policy** information page appears.
4. In the **Policy Information** pane, type the following information:
 - **Policy Name:** Type a descriptive name for the policy.
 - **Description:** Type an optional description of the policy.
5. Click **Next**. The **Samsung KNOX Platform** page appears.

The screenshot shows the XenMobile console interface. The top navigation bar includes 'XenMobile', 'Analyze', 'Manage', and 'Configure'. The 'Configure' section is active, showing 'Device Policies', 'Apps', 'Actions', 'ShareFile', and 'Delivery Groups'. The 'App Restrictions Policy' page is displayed, featuring a 'Policy Information' section with a description: 'This policy lets you create blacklists for apps you want to prevent users from installing on Samsung KNOX devices, as well as whitelists for apps you want to allow users to install.' Below this is a table with columns for 'Allow/Deny', 'New app restriction*', and 'Add'. A 'Deployment Rules' section is also visible. The left sidebar shows a list of policy steps: '1 Policy Info', '2 Platforms', '3 Assignment', and 'Samsung KNOX' (which is selected). At the bottom right, there are 'Back' and 'Next >' buttons.

6. For each app you want to add to the Allow/Deny list, click **Add** and then do the following:

- **Allow/Deny:** Select whether users are allowed to install the app.
- **New app restriction:** Type the app package ID; for example, com.kmdm.af.crackle.
- Click **Save** to save the app to the Allow/Deny list or click **Cancel** to not save the app to the Allow/Deny list.

Note: To delete an existing app, hover over the line containing the listing and then click the trash can icon on the right-hand side. A confirmation dialog box appears. Click **Delete** to delete the listing or **Cancel** to keep the listing.

To edit an existing app, hover over the line containing the listing and then click the pen icon on the right-hand side. Make any changes to the listing and then click **Save** to save the changed listing or **Cancel** to leave the listing unchanged.

7. Configure deployment rules and choose delivery groups. For more information, see [Add a device policy](#).

App tunneling device policy

Jun 19, 2017

Application tunnels (app tunnels) are designed to increase service continuity and data transfer reliability for your mobile apps. App tunnels define proxy parameters between the client component of any mobile device app and the app server component. You can also use app tunnels to create remote support tunnels to a device for management support. You can configure the app tunneling policy for Android and Windows Mobile/CE devices.

Note: Any app traffic sent through a tunnel that you define in this policy goes through XenMobile before being redirected to the server running the app.

[Android settings](#)

[Windows Mobile/CE settings](#)

1. In the XenMobile console, click **Configure > Device Policies**. The **Device Policies** page appears.
 2. Click **Add**. The **Add a New Policy** dialog box appears.
 3. Click **More** and then, under **Network access**, click **Tunnel**. The **Tunnel Policy** page appears.
 4. In the **Policy Information** pane, enter the following information:
 - **Policy Name:** Type a descriptive name for the policy.
 - **Description:** Optionally, type a description of the policy.
 5. Click **Next**. The **Policy Platforms** page appears.
 6. Under **Platforms**, select the platforms you want to add. If you are only configuring for one platform, clear the others.
- When you finish configuring the settings for a platform, refer to Step 7 for how to set that platform's deployment rules.

The screenshot shows the XenMobile configuration interface. At the top, there are navigation tabs: Analyze, Manage, and Configure. The Configure tab is active. Below the navigation, there are sub-tabs: Device Policies, Apps, Actions, ShareFile, and Delivery Groups. The main content area is titled 'Tunnel Policy' and contains a sidebar with three sections: '1 Policy Info', '2 Platforms', and '3 Assignment'. Under '2 Platforms', 'Android' and 'Windows Mobile/CE' are checked. The main configuration area is titled 'Policy Information' and includes a description: 'This policy lets you configure an app tunnel. While doing so, you can choose if the tunnel will be used for the remote support app.' The configuration options are:

- 'Use this tunnel for remote support' is a toggle switch set to 'OFF'.
- 'Connection configuration' section:
 - 'Connection initiated by' is a dropdown menu set to 'Device'.
 - 'Maximum connections per device*' is a text input field containing '1'.
 - 'Define connection time out' is a toggle switch set to 'OFF'.
 - 'Block cellular connections passing by this tunnel' is a toggle switch set to 'OFF'.
- 'App device parameters' section:
 - 'Client port*' is an empty text input field.
- 'App server parameters' section:
 - 'IP address or server name*' is an empty text input field.
 - 'Server port*' is an empty text input field.

 At the bottom right of the configuration area, there are 'Back' and 'Next >' buttons.

Configure these settings:

- **Use this tunnel for remote support:** Select whether the tunnel will be used for remote support.
 - Note:** The configuration steps are different depending on whether you select remote support.
- If you do not select remote support, do the following:
 - **Connection initiated by:** Click **Device** or **Server** to specify the source initiating the connection.
 - **Maximum connections per device:** Type a number to specify how many concurrent TCP connections the app can establish. This field applies only to device-initiated connections.
 - **Define connection time out:** Select whether to set a length of time an app can be idle before the tunnel is closed.
 - **Connection time out:** If you set **Define connection time out** to **On**, type the length of time in seconds that an app can be idle before the tunnel is closed.
 - **Block cellular connections passing by this tunnel:** Select whether this tunnel is blocked while roaming.
 - Note:** WiFi and USB connections will not be blocked.
 - **Client port:** Type the client port number. In most cases, this value is the same as for the server port.
 - **IP address or server name:** Type the IP address or name of the app server. This field applies only to device-initiated connections.
 - **Server port:** Type the server port number.
- If you do select remote support, do the following:
 - **Use this tunnel for remote support:** Set to **On**.

- **Define connection time out:** Select whether to set a length of time an app can be idle before the tunnel is closed.
 - **Connection time out:** If you set **Define connection time out to On**, type the length of time in seconds that an app can be idle before the tunnel is closed.
- **Use SSL connection:** Select whether to use a secure SSL connection for this tunnel.
- **Block cellular connections passing by this tunnel:** Select whether this tunnel is blocked while roaming.
Note: WiFi and USB connections will not be blocked.

The screenshot shows the XenMobile Configure interface. The top navigation bar includes 'XenMobile', 'Analyze', 'Manage', and 'Configure'. Below this, there are tabs for 'Device Policies', 'Apps', 'Actions', 'ShareFile', and 'Delivery Groups'. The main content area is titled 'Tunnel Policy' and is divided into three sections: '1 Policy Info', '2 Platforms', and '3 Assignment'. Under '2 Platforms', 'Android' and 'Windows Mobile/CE' are listed with checkboxes, and 'Windows Mobile/CE' is selected. The 'Policy Information' section contains the following settings:

- Use this tunnel for remote support:** OFF
- Connection configuration:**
 - Connection initiated by:** Device
 - Protocol:** Generic TCP
 - Maximum connections per device*:** 1
 - Define connection time out:** OFF
 - Block cellular connections passing by this tunnel:** OFF
- App device parameters:**
 - Redirect to XenMobile:** Through app settings
 - Client port*:** (empty field)
- App server parameters:**
 - IP address or server name*:** (empty field)
 - Server port*:** (empty field)

At the bottom right, there are 'Back' and 'Next >' buttons.

Configure these settings:

- **Use this tunnel for remote support:** Select whether the tunnel will be used for remote support.
Note: The configuration steps are different depending on whether you select remote support.
- If you do not select remote support, do the following:
 - **Connection initiated by:** Click **Device** or **Server** to specify the source initiating the connection.
 - **Protocol:** In the list, click the protocol to use. The default is **Generic TCP**.
 - **Maximum connections per device:** Type a number to specify how many concurrent TCP connections the app can

establish. This field applies only to device-initiated connections.

- **Define connection time out:** Select whether to set a length of time an app can be idle before the tunnel is closed.
 - **Connection time out:** If you set **Define connection time out** to **On**, type the length of time in seconds that an app can be idle before the tunnel is closed.
- **Block cellular connections passing by this tunnel:** Select whether this tunnel is blocked while roaming.
Note: WiFi and USB connections will not be blocked.
- **Redirect to XenMobile:** In the list, click how the device connects to XenMobile. The default is **Through app settings**.
 - If you select **Using a local alias**, type the alias in **Local alias**. The default is **localhost**.
 - If you select **An IP address range**, type the from IP address in **IP address range from** and type the to IP address in **IP address range to**.
- **Client port:** Type the client port number. In most cases, this value is the same as for the server port.
- **IP address or server name:** Type the IP address or name of the app server. This field applies only to device-initiated connections.
- **Server port:** Type the server port number.
- If you do select remote support, do the following:
 - **Use this tunnel for remote support:** Set to **On**.
 - **Define connection time out:** Select whether to set a length of time an app can be idle before the tunnel is closed.
 - **Connection time out:** If you set **Define connection time out** to **On**, type the length of time in seconds that an app can be idle before the tunnel is closed.
 - **Use SSL connection:** Select whether to use a secure SSL connection for this tunnel.
 - **Block cellular connections passing by this tunnel:** Select whether this tunnel is blocked while roaming.
Note: WiFi and USB connections will not be blocked.

7. Configure deployment rules and choose delivery groups. For more information, see [Add a device policy](#).

App uninstall device policy

Jun 19, 2017

You can create an app uninstall policy for iOS, Android, Samsung KNOX, Android for Work, Windows desktop/tablet, and Windows Mobile/CE platforms. An app uninstall policy lets you remove apps from users' devices for any number of reasons. It may be that you no longer want to support certain apps, your company may want to replace existing apps with similar apps from different vendors, and so on. The apps are removed when this policy is deployed to your users' devices. With the exception of Samsung KNOX devices, users receive a prompt to uninstall the app; Samsung KNOX device users do not receive a prompt to uninstall the app.

1. In the XenMobile console, click **Configure** > **Device Policies**. The **Device Policies** page appears.
 2. Click **Add**. The **Add a New Policy** dialog box appears.
 3. Expand **More** and then, under **Apps**, click **App Uninstall**. The **App Uninstall Policy** page appears.
 4. In the **Policy Information** pane, enter the following information:
 - **Policy Name:** Type a descriptive name for the policy.
 - **Description:** Type an optional description of the policy.
 5. Click **Next**. The **Policy Platforms** page appears.
 6. Under **Platforms**, select the platforms you want to add. If you are only configuring for one platform, clear the others.
- When you finish configuring the settings for a platform, refer to Step 7 for how to set that platform's deployment rules.

The screenshot shows the XenMobile console interface for configuring an 'App Uninstall Policy'. The top navigation bar includes 'XenMobile', 'Analyze', 'Manage', and 'Configure'. Below this, there are tabs for 'Device Policies', 'Apps', 'Actions', 'ShareFile', and 'Delivery Groups'. The main content area is divided into a left sidebar and a main panel. The sidebar has three sections: '1 Policy Info', '2 Platforms', and '3 Assignment'. The '2 Platforms' section is expanded, showing a list of platforms with checkboxes: iOS, Android, Samsung KNOX, Android for Work, Windows Desktop/Tablet, and Windows Mobile/CE. The main panel is titled 'Policy Information' and contains a description: 'This policy lets you specify which apps need to be uninstalled. You can perform silent removal only on Samsung KNOX devices. If you don't find the app in the list, use the package name.' Below the description is a field for 'Managed app bundle ID' with a dropdown menu labeled 'Make a selection'. There is also a section for 'Deployment Rules' which is currently collapsed. At the bottom right of the main panel, there are 'Back' and 'Next >' buttons.

Configure this setting:

- **Managed app bundle ID:** in the list, click an existing app or click **Add new**. If there are no apps configured for this platform, the list will be empty and you must add a new app.
 - When you click **Add**, a field appears where you can type an app name.

The screenshot shows the XenMobile interface for configuring an App Uninstall Policy. The top navigation bar includes 'XenMobile', 'Analyze', 'Manage', and 'Configure'. Below this, there are tabs for 'Device Policies', 'Apps', 'Actions', 'ShareFile', and 'Delivery Groups'. The main content area is titled 'App Uninstall Policy' and 'Policy Information'. The 'Policy Information' section explains that the policy allows for silent removal of apps on Samsung KNOX devices. Below this, there is a section for 'Apps to uninstall' with a table containing an 'App Name' column and an 'Add' button. A 'Deployment Rules' section is also visible. At the bottom right, there are 'Back' and 'Next >' buttons.

Configure this setting:

- **Apps to uninstall:** For each app you want to add, click **Add** and then do the following:
 - **App name:** In the list, click an existing app or click **Add new** to enter a new app name. If there are no apps configured for this platform, the list will be empty and you must add new apps.
 - Click **Add** to add the app or click **Cancel** to cancel adding the app.

Note: To delete an existing app from the uninstall policy, hover over the line containing the listing and then click the trash can icon on the right-hand side. A confirmation dialog box appears. Click **Delete** to delete the listing or **Cancel** to keep the listing.

To edit an existing app, hover over the line containing the listing and click the pen icon on the right-hand side. Make any changes to the listing and then click **Save** to save the changed listing or **Cancel** to leave the listing unchanged.

7. Configure deployment rules and choose delivery groups. For more information, see [Add a device policy](#).

You can configure XenMobile to remove the Enterprise version of Citrix apps upon installation of the public app store version. This feature prevents user devices from having two identical app icons after the public app store version installs.

A deployment condition for the App Uninstall device policy triggers XenMobile to remove older apps from user devices upon

installation of the new version. This feature is available only for managed iOS devices connected to a XenMobile Server in enterprise mode (XME).

To configure a deployment rule with the Installed app name condition:

- Specify the **Managed app bundle ID** for the Enterprise app.
- Add a rule: Click **New Rule** and then, as shown in the sample, choose **Installed app name** and **is equal to**. Type the app bundle ID for the public app store app.

The screenshot shows the XenMobile configuration interface. The top navigation bar includes 'XenMobile', 'Analyze', 'Manage', and 'Configure'. Below this, there are tabs for 'Device Policies', 'Apps', 'Actions', 'ShareFile', 'Enrollment Profiles', and 'Delivery Groups'. The main content area is titled 'App Uninstall Policy' and includes a sidebar with sections for '1 Policy Info', '2 Platforms', and '3 Assignment'. Under '2 Platforms', several options are checked: iOS, Android, Samsung KNOX, Android for Work, Windows Phone, Windows Desktop/Tablet, and Windows Mobile/CE. The main configuration area shows a 'Managed app bundle ID*' dropdown set to 'com.citrix.mail'. Below this, the 'Deployment Rules' section is expanded, showing a 'Base' tab and an 'Advanced' tab. The 'Advanced' tab displays a rule configuration: 'Deploy when' is set to 'All', 'conditions are met' is set to 'New Rule', and the rule condition is 'Installed app name' is equal to 'com.citrix.mail.ios'.

In the example, when the public app store app (com.citrix.mail.ios) installs on a device in the delivery groups specified, XenMobile removes the Enterprise version (com.citrix.mail).

App uninstall restrictions device policy

Jun 19, 2017

You can specify the apps users can or cannot uninstall on a Samsung SAFE or Amazon device.

1. In the XenMobile console, click **Configure > Device Policies**.
2. Click **Add**. The **Add a New Policy** dialog box appears.
3. Expand **More**, and then under **Apps**, click **App Uninstall Restrictions**. The **App Uninstall Restrictions Policy** information page appears.
4. On the **Policy Information** pane, enter the following information:
 - **Policy Name:** Type a descriptive name for the policy.
 - **Description:** Type an optional description of the policy.
5. Click **Next**. The **Policy Platforms** page appears.

The screenshot shows the XenMobile console interface. The top navigation bar includes 'XenMobile', 'Analyze', 'Manage', and 'Configure'. Below this, there are tabs for 'Device Policies', 'Apps', 'Actions', 'ShareFile', and 'Delivery Groups'. The main content area is titled 'App Uninstall Restrictions Policy' and contains a 'Policy Information' section. This section includes a description: 'This policy lets you specify the apps users can or cannot uninstall on a Samsung SAFE or Amazon device.' Below the description is a table for 'App Uninstall Restriction Settings' with columns for 'App Name*' and 'Rule', and an 'Add' button. There is also a 'Deployment Rules' section. On the left, a sidebar shows '1 Policy Info', '2 Platforms', and '3 Assignment'. Under '2 Platforms', 'Samsung SAFE' and 'Amazon' are selected with checkboxes. At the bottom right, there are 'Back' and 'Next >' buttons.

6. Under **Platforms**, select the platforms you want to add. If you are only configuring for one platform, clear the others. When you finish configuring the settings for a platform, refer to Step 7 for how to set that platform's deployment rules.
7. Configure these settings for each platform you selected:
 - **App Uninstall Restrictions Settings:** For each app rule you want to add, click **Add** and then do the following:
 - **App Name:** In the list, click an app or **Add new** to add a new app.
 - **Rule:** Select whether users can uninstall the app. The default is to allow uninstallation.
 - Click **Save** or **Cancel**.

Note: To delete an existing app, hover over the line containing the listing and then click the trash can icon on the right-hand side. A confirmation dialog box appears. Click **Delete** to delete the listing or **Cancel** to keep the listing.

To edit an existing app, hover over the line containing the listing and then click the pen icon on the right-hand side. Make any changes to the listing and then click **Save** to save the changed listing or **Cancel** to leave the listing unchanged.

8. Configure deployment rules and choose delivery groups. For more information, see [Add a device policy](#).

Browser device policy

Jun 19, 2017

You can create browser device policies for Samsung SAFE or Samsung KNOX devices to define whether users' devices can use the browser or to limit the browser functions that the devices can use.

On Samsung devices, you can completely disable the browser, or you can enable or disable pop-ups, JavaScript, cookies, autofill, and whether to force fraud warnings.

[Samsung SAFE and Samsung KNOX settings](#)

1. In the XenMobile console, click **Configure > Device Policies**. The **Device Policies** page appears.
 2. Click **Add** to add a new policy. The **Add a New Policy** dialog box appears.
 3. Click **More**, and then under **Apps**, click **Browser**. The **Browser Policy** information page appears.
 4. In the **Policy Information** pane, enter the following information:
 - **Policy Name:** Type a descriptive name for the policy.
 - **Description:** Type an optional description of the policy.
 5. Click **Next**. The **Policy Platforms** page appears.
 6. Under **Platforms**, select the platforms you want to add. If you are only configuring for one platform, clear the others.
- When you finish configuring the settings for a platform, refer to Step 7 for how to set that platform's deployment rules.

Configure these settings:

- **Disable browser:** Select whether to completely disable the Samsung browser on users' devices. The default is **OFF**, which lets users use the browser. When you disable the browser, the following options disappear.
- **Disable pop-up:** Select whether to allow pop-up messages on the browser.
- **Disable Javascript:** Select whether to allow JavaScript to run on the browser.
- **Disable cookies:** Select whether to allow cookies.
- **Disable autofill:** Select whether to allow users to turn on the browser's autofill function.
- **Force fraud warning:** Select whether to display a warning when users visit a fraudulent or compromised website.

8. Configure deployment rules and choose delivery groups. For more information, see [Add a device policy](#).

Calendar (CalDav) device policy

Jun 19, 2017

You can add a device policy in XenMobile to add a calendar (CalDAV) account to users' iOS or Mac OS X devices to enable them to synchronize scheduling data with any server that supports CalDAV.

1. In the XenMobile console, click **Configure > Device Policies**. The **Device Policies** page appears.
 2. Click **Add**. The **Add a New Policy** dialog box appears.
 3. Expand **More** and then, under **End user**, click **Calendar (CalDAV)**. The **Calendar (CalDAV) Policy** page appears.
 4. In the **Policy Information** pane, enter the following information:
 - **Policy Name**: Type a descriptive name for the policy.
 - **Description**: Optionally, type a description of the policy.
 5. Click **Next**. The **Platforms** page appears.
 6. Under **Platforms**, select the platforms you want to add. If you are only configuring for one platform, clear the others.
- When you finish configuring the settings for a platform, refer to Step 7 for how to set that platform's deployment rules.

XenMobile Analyze Manage **Configure** ⚙️ 🔍 admin ▾

Device Policies Apps Actions ShareFile Delivery Groups

Calendar (CalDAV) Policy

- Policy Info
- Platforms
 - iOS
 - Mac OS X
- Assignment

Policy Information

This policy lets you add a calendar (CalDAV) account to an iOS and Mac OS X device to enable synchronization of scheduling data with any server that supports CalDAV.

Account description*

Host name*

Port*

Principal URL*

User name*

Password

Use SSL ON

Policy Settings

Remove policy Select date Duration until removal (in days)

Allow user to remove policy ▾

► **Deployment Rules**

Configure the following settings:

- **Account description:** Type an account description. This field is required.
- **Host name:** Type the address of the CalDAV server. This field is required.
- **Port:** Type the port on which to connect to the CalDAV server. This field is required. The default is **8443**.
- **Principal URL:** Type the base URL to the user's calendar.
- **User name:** Type the user's logon name. This field is required.
- **Password:** Type an optional user password.
- **Use SSL:** Select whether to use a Secure Socket Layer connection to the CalDAV server. The default is **ON**.
- **Policy Settings**
 - Next to **Remove policy**, click either **Select date** or **Duration until removal (in hours)**.
 - If you click **Select date**, click the calendar to select the specific date for removal.
 - In the **Allow user to remove policy** list, click **Always**, **Password required**, or **Never**.
 - If you click **Password required**, next to **Removal password**, type the necessary password.

XenMobile Analyze Manage **Configure** ⚙️ 🔍 admin ▾

Device Policies Apps Actions ShareFile Delivery Groups

Calendar (CalDAV) Policy ✕

- 1 Policy Info
- 2 Platforms
 - iOS
 - Mac OS X
- 3 Assignment

Policy Information

This policy lets you add a calendar (CalDAV) account to an iOS and Mac OS X device to enable synchronization of scheduling data with any server that supports CalDAV.

Account description*

Host name*

Port*

Principal URL*

User name*

Password

Use SSL

Policy Settings

Remove policy Select date Duration until removal (in days)

Allow user to remove policy

Profile scope OS X 10.7+

► **Deployment Rules**

Configure the following settings:

- **Account description:** Type an account description. This field is required.
- **Host name:** Type the address of the CalDAV server. This field is required.
- **Port:** Type the port on which to connect to the CalDAV server. This field is required. The default is **8443**.
- **Principal URL:** Type the base URL to the user's calendar.
- **User name:** Type the user's logon name. This field is required.
- **Password:** Type an optional user password.
- **Use SSL:** Select whether to use a Secure Socket Layer connection to the CalDAV server. The default is **ON**.
- **Policy Settings**
 - Next to **Remove policy**, click either **Select date** or **Duration until removal (in hours)**.
 - If you click **Select date**, click the calendar to select the specific date for removal.
 - In the **Allow user to remove policy** list, click **Always**, **Password required**, or **Never**.
 - If you click **Password required**, next to **Removal password**, type the necessary password.
 - Next to **Profile scope**, click either **User** or **System**. The default is **User**. This option is available only on OS X 10.7 and later.

7. Configure deployment rules and choose delivery groups. For more information, see [Add a device policy](#).

Cellular device policy

Jun 19, 2017

This policy allows you to configure cellular network settings on an iOS device.

1. In the XenMobile console, click **Configure > Device Policies**. The **Device Policies** page appears.
2. Click **Add**. The **Add a New Policy** page appears.
3. Expand **More**, and then, under **Network Access**, click **Cellular**. The **Cellular Network Policy** information page appears.
4. In the **Policy Information** pane, enter the following information:
 - **Policy Name**: Type a descriptive name for the policy.
 - **Description**: Optionally, type a description of the policy.
5. Click **Next**. The **iOS Platform** information page appears.

XenMobile Analyze Manage **Configure** ⚙️ 🔍 admin ▾

Device Policies Apps Actions ShareFile Delivery Groups

Cellular Policy

- 1 Policy Info
- 2 Platforms
 - iOS
- 3 Assignment

Policy Information

This policy lets you configure cellular network settings on an iOS device.

Attach APN

Name

Authentication type

User name

Password

APN

Name

Authentication type

User name

Password

Proxy server

Proxy server port

Policy Settings

Remove policy Select date Duration until removal (in days)

Allow user to remove policy

► **Deployment Rules**

6. Configure these settings:

- **Attach APN**
 - **Name:** Type a name for this configuration.
 - **Authentication type:** In the list, click Challenge Handshake Authentication Protocol (**CHAP**) or Password Authentication Protocol (**PAP**). The default is **PAP**.
 - **User name:** Type a user name used for authentication.
- **APN**
 - **Name:** Type a name for the Access Point Name (APN) configuration.
 - **Authentication type:** In the list, click **CHAP** or **PAP**. The default is **PAP**.
 - **User name:** Type a user name used for authentication.
 - **Password:** Type a password used for authentication.
 - **Proxy server:** Type the proxy server network address.

- **Policy Settings**

- Next to **Remove policy**, click either **Select date** or **Duration until removal (in hours)**.
- If you click **Select date**, click the calendar to select the specific date for removal.
- In the **Allow user to remove policy** list, click **Always**, **Password required**, or **Never**.
- If you click **Password required**, next to **Removal password**, type the necessary password.

8. Configure deployment rules and choose delivery groups. For more information, see [Add a device policy](#).

Connection manager device policy

Jun 19, 2017

In XenMobile, you can specify the connection settings for apps that connect automatically to the Internet and to private networks. This policy is only available on Windows Pocket PCs.

1. In the XenMobile console, click **Configure > Device Policies**. The **Device Policies** page appears.
2. Click **Add**. The **Add a New Policy** dialog box appears.
3. Click **More**, and then, under **Network Access**, click **Connection manager**. The **Connection Manager** policy information page appears.
4. In the **Policy Information** pane, enter the following information:
 - **Policy Name:** Type a descriptive name for the policy.
 - **Description:** Type an optional description of the policy.
5. Click **Next**. The **Windows Mobile/CE Platform** page appears.

The screenshot shows the XenMobile console interface. At the top, there is a navigation bar with 'XenMobile' and tabs for 'Analyze', 'Manage', and 'Configure'. Below this, there are sub-tabs for 'Device Policies', 'Apps', 'Actions', 'ShareFile', and 'Delivery Groups'. The main content area is titled 'Connection Manager Policy' and includes a 'Policy Information' section. This section contains two dropdown menus: 'Apps that connect to a private network automatically use' and 'Apps that connect to the Internet automatically use', both currently set to 'Built-in office'. Below these is a 'Deployment Rules' section. On the left, a sidebar shows a navigation menu with 'Windows Mobile/CE' selected. At the bottom right, there are 'Back' and 'Next >' buttons.

6. Configure these settings.

Note: **Built-in office** means all connections are to your company's intranet and **Built-in Internet** means that all connections are to the Internet.

- **Apps that connect to a private network automatically use:** In the list, click either **Built-in office** or **Built-in Internet**. The default is **Built-in office**.
- **Apps that connect to the Internet automatically use:** In the list, click either **Built-in office** or **Built-in Internet**. The default is **Built-in office**.

7. Configure deployment rules and choose delivery groups. For more information, see [Add a device policy](#).

Connection scheduling device policy

Jun 19, 2017

You create connection scheduling policies to control how and when users' devices connect to XenMobile. Note that you can configure this policy for devices enabled for Android for Work as well.

You can specify that users connect their devices manually, that devices stay connected permanently, or that devices connect within a defined time frame.

1. In the XenMobile console, click **Configure** > **Device Policies**. The **Device Policies** page appears.
2. Click **Add**. The **Add a New Policy** dialog box appears.
3. Click **Scheduling**. The **Connection Scheduling Policy** information page appears.
4. In the **Policy Information** pane, enter the following information:
 - **Policy Name:** Type a descriptive name for the policy.
 - **Description:** Type an optional description of the policy.
5. Click **Next**. The **Policy Platforms** page appears.

The screenshot shows the XenMobile console interface. The top navigation bar includes 'XenMobile', 'Analyze', 'Manage', and 'Configure'. Below this is a secondary navigation bar with 'Device Policies', 'Apps', 'Actions', 'ShareFile', and 'Delivery Groups'. The main content area is titled 'Connection Scheduling Policy' and is divided into two main sections: 'Policy Information' and 'Deployment Rules'. The 'Policy Information' section contains a description and a 'Require devices to connect' section with four radio button options: 'Always' (selected), 'Never', 'Every', and 'Define schedule'. The 'Deployment Rules' section is currently collapsed. On the left side, there is a sidebar with a 'Platforms' section containing three checked items: 'Android', 'Android for Work', and 'Windows Mobile/CE'. At the bottom right, there are 'Back' and 'Next >' buttons.

6. Under **Platforms**, select the platforms you want to add. If you are only configuring for one platform, clear the others.

When you finish configuring the settings for a platform, refer to Step 8 for how to set that platform's deployment rules.

7. Configure the following settings for each of the platforms you selected:

- **Require devices to connect:** Click the option you want to set for this schedule.
 - **Always:** Keep the connection alive permanently. XenMobile on the user's device attempts to reconnect to the XenMobile server after a network connection loss and will monitor the connection by transmitting control packets at regular intervals. Citrix recommends this option for optimized security. When you choose **Always**, also use for the

device **Tunnel Policy**, the **Define connection time-out** setting to ensure the connection is not draining battery. By keeping the connection alive, you can push security commands like wipe or lock to the device on-demand. You must also select the **Deployment Schedule** option **Deploy for always-on connections** in each policy deployed to the device.

- **Never**: Connect manually. Users must initiate the connection from XenMobile on their devices. Citrix doesn't recommend this option for production deployments because it prevents you from deploying security policies to devices, thus users will never receive any new apps or policies.
- **Every**: Connect at the designated interval. When this option is in effect and you send a security policy such as a lock or a wipe, XenMobile processes the action on the device the next time the device connects. When you select this option, the **Connect every N minutes** field appears where you must enter the number of minutes after which the device must reconnect. The default is 20.
- **Define schedule**: When enabled, XenMobile on the user's device attempts to reconnect to the XenMobile server after a network connection loss and monitors the connection by transmitting control packets at regular intervals within the time frame you define. See [Defining a connection time frame](#) for how to define a connection time frame.
 - **Maintain permanent connection during these hours**: Users' devices must be connected for the defined time frame.
 - **Require a connection within each of these ranges**: Users' devices must be connected at least once in any of the defined time frames.
 - **Use local device time rather than UTC**: Synchronize the defined time frames to local device time rather than Coordinated Universal Time (UTC).

Defining a connection time frame

When you enable the following options, a timeline appears where you can define the time frames you want. You can enable either or both options to require a permanent connection during specific hours or to require a connection within certain time frames. Each square in the timeline is 30 minutes, so if you want a connection between 8:00 AM and 9:00 AM every weekday, you click the two squares on the timeline between 8 AM and 9 AM every weekday.

For example, the two timelines in the following figure require a permanent connection between 8:00 AM and 9:00 AM every weekday, a permanent connection between 12:00 AM Saturday and 1:00 AM Sunday, and at least one connection every weekday between 5:00 AM and 8:00 AM or between 10:00 AM and 11:00 PM.

Define schedule

Maintain permanent connection during these hours

1 AM 2 AM 3 AM 4 AM 5 AM 6 AM 7 AM 8 AM 9 AM 10 AM 11 AM 12 PM 1 PM 2 PM 3 PM 4 PM 5 PM 6 PM 7 PM 8 PM 9 PM 10 PM 11 PM 12 AM

Day	1 AM	2 AM	3 AM	4 AM	5 AM	6 AM	7 AM	8 AM	9 AM	10 AM	11 AM	12 PM	1 PM	2 PM	3 PM	4 PM	5 PM	6 PM	7 PM	8 PM	9 PM	10 PM	11 PM	12 AM
Mon								■	■															
Tue								■	■															
Wed								■	■															
Thu								■	■															
Fri								■	■															
Sat																								■
Sun	■																							

Require a connection within each of these ranges

1 AM 2 AM 3 AM 4 AM 5 AM 6 AM 7 AM 8 AM 9 AM 10 AM 11 AM 12 PM 1 PM 2 PM 3 PM 4 PM 5 PM 6 PM 7 PM 8 PM 9 PM 10 PM 11 PM 12 AM

Day	1 AM	2 AM	3 AM	4 AM	5 AM	6 AM	7 AM	8 AM	9 AM	10 AM	11 AM	12 PM	1 PM	2 PM	3 PM	4 PM	5 PM	6 PM	7 PM	8 PM	9 PM	10 PM	11 PM	12 AM
Mon					■	■	■			■	■	■	■	■	■	■	■	■	■	■	■	■	■	
Tue					■	■	■			■	■	■	■	■	■	■	■	■	■	■	■	■	■	
Wed					■	■	■			■	■	■	■	■	■	■	■	■	■	■	■	■	■	
Thu					■	■	■			■	■	■	■	■	■	■	■	■	■	■	■	■	■	
Fri					■	■	■			■	■	■	■	■	■	■	■	■	■	■	■	■	■	
Sat					■	■	■			■	■	■	■	■	■	■	■	■	■	■	■	■	■	
Sun																								

Use local device time rather than UTC

8. Configure deployment rules and choose delivery groups. For more information, see [Add a device policy](#).

Contacts (CardDAV) device policy

Jun 19, 2017

You can add a device policy in XenMobile to add an iOS contacts (CardDAV) account to users' iOS or Mac OS X devices to enable them to synchronize contact data with any server that supports CardDAV.

1. In the XenMobile console, click **Configure** > **Device Policies**. The **Device Policies** page appears.
 2. Click **Add**. The **Add a New Policy** dialog box appears.
 3. Expand **More** and then, under **Security**, click **Contacts CardDAV**. The **CardDAV Policy** page appears.
 4. In the **Policy Information** pane, Type the following information:
 - **Policy Name:** Type a descriptive name for the policy.
 - **Description:** Optionally, type a description of the policy.
 5. Click **Next**. The **Platforms** page appears.
 6. Under **Platforms**, select the platforms you want to add. If you are only configuring for one platform, clear the others.
- When you finish configuring the settings for a platform, refer to Step 7 for how to set that platform's deployment rules.

XenMobile Analyze Manage **Configure** ⚙️ 🔍 admin ▾

Device Policies Apps Actions ShareFile Delivery Groups

CardDAV Policy

- 1 Policy Info
- 2 Platforms
 - iOS
 - Mac OS X
- 3 Assignment

Policy Information

This policy lets you add contacts (CardDAV) accounts for iOS and Mac OS X to an iOS or Mac OS X device to enable synchronization of contact data with any server that supports CardDAV.

Account description*

Host name*

Port*

Principal URL*

User name*

Password

Use SSL ON

Policy Settings

Remove policy Select date Duration until removal (in days)

Allow user to remove policy ▾

► **Deployment Rules**

Configure these settings:

- **Account description:** Type an account description. This field is required.
- **Host name:** Type the address of the CardDAV server. This field is required.
- **Port:** Type the port on which to connect to the CardDAV server. This field is required. The default is **8443**.
- **Principal URL:** Type the base URL to the user's calendar.
- **User name:** Type the user's logon name. This field is required.
- **Password:** Type an optional user password.
- **Use SSL:** Select whether to use a Secure Socket Layer connection to the CardDAV server. The default is **ON**.
- **Policy Settings**
 - Next to **Remove policy**, click either **Select date** or **Duration until removal (in hours)**.
 - If you click **Select date**, click the calendar to select the specific date for removal.
 - In the **Allow user to remove policy** list, click **Always**, **Password required**, or **Never**.
 - If you click **Password required**, next to Removal password, type the necessary password.

XenMobile Analyze Manage **Configure** ⚙️ 🔍 admin ▾

Device Policies Apps Actions ShareFile Delivery Groups

CardDAV Policy

- Policy Info
- Platforms
 - iOS
 - Mac OS X
- Assignment

Policy Information

This policy lets you add contacts (CardDAV) accounts for iOS and Mac OS X to an iOS or Mac OS X device to enable synchronization of contact data with any server that supports CardDAV.

Account description*

Host name*

Port*

Principal URL*

User name*

Password

Use SSL

Policy Settings

Remove policy Select date Duration until removal (in days)

Allow user to remove policy ▾

Profile scope ▾ OS X 10.7+

► Deployment Rules

Configure these settings:

- **Account description:** Type an account description. This field is required.
- **Host name:** Type the address of the CardDAV server. This field is required.
- **Port:** Type the port on which to connect to the CardDAV server. This field is required. The default is **8443**.
- **Principal URL:** Type the base URL to the user's calendar.
- **User name:** Type the user's logon name. This field is required.
- **Password:** Type an optional user password.
- **Use SSL:** Select whether to use a Secure Socket Layer connection to the CardDAV server. The default is **ON**.
- **Policy Settings**
 - Next to **Remove policy**, click either **Select date** or **Duration until removal (in hours)**.
 - If you click **Select date**, click the calendar to select the specific date for removal.
 - In the **Allow user to remove policy** list, click **Always**, **Password required**, or **Never**.
 - If you click **Password required**, next to Removal password, type the necessary password.
 - Next to **Profile scope**, click either **User** or **System**. The default is **User**. This option is available only on OS X 10.7 and later.

7. Configure deployment rules and choose delivery groups. For more information, see [Add a device policy](#).

Control OS Updates device policy

Jun 19, 2017

The Control OS Updates device policy lets you deploy the latest OS updates to supervised iOS devices. You can specify how frequently that XenMobile checks the device OS and deploys updates.

iOS options

OS update options: Both of the options download the latest OS updates to supervised devices according to the **OS update frequency**. The device prompts users to install updates. The prompt is visible after the user unlocks the device.

OS update frequency: Determines how frequently XenMobile checks and updates the device OS. The default is 7 days.

Note

For general information about configuring policies, see [Add a device policy](#).

Copy Apps to Samsung Container device policy

Jun 19, 2017

You can specify apps that are already installed on a device be copied to a SEAMS container or to a KNOX container on supported Samsung devices (for information about supported devices, see Samsung's [Samsung KNOX Supported Devices](#) page). Apps copied to the SEAMS container are available on users' home screens; apps copied to the KNOX container are only available when users sign in to the KNOX container.

Prerequisites:

- Device must be enrolled on XenMobile.
- The Samsung MDM keys (ELM and KLM) must be deployed (for how to do this, see Samsung MDM License Key device policies).
- Apps are already installed on device
- Initialize KNOX on the device to copy apps to the KNOX container.

1. In the XenMobile console, click **Configure > Device Policies**.

2. Click **Add**. The **Add a New Policy** dialog box appears.

3. Expand **More**, and then under **Security**, click **Copy Apps to Samsung Container**. The **Copy Apps to Samsung Container Policy** information page appears.

4. On the **Policy Information** pane, enter the following information:

- **Policy Name:** Type a descriptive name for the policy.
- **Description:** Type an optional description of the policy.

5. Click **Next**. The **Policy Platforms** page appears.

The screenshot displays the XenMobile console interface. The top navigation bar includes 'XenMobile', 'Analyze', 'Manage', and 'Configure'. The 'Configure' section is active, showing 'Device Policies' as the selected category. The main content area is titled 'Copy Apps to Samsung Container Policy' and contains a 'Policy Information' pane. This pane includes a 'New app*' input field with an 'Add' button. Below the input field is a 'Deployment Rules' section. On the left side, a sidebar lists the configuration steps: '1 Policy Info', '2 Platforms', and '3 Assignment'. Under '2 Platforms', 'Samsung SEAMS' and 'Samsung KNOX' are both checked. At the bottom right, there are 'Back' and 'Next >' buttons.

6. Under Platforms, select the platforms you want to add. If you are only configuring for one platform, clear the others.

When you finish configuring the settings for a platform, refer to Step 8 for how to set that platform's deployment rules.

7. Configure the following setting for each platform you select.

- **New app:** For each app you want to add to the list, click **Add** and then do the following:
 - Type a package ID; for example, com.mobewolf.lacingart fo the LacingArt app.
 - Click **Save** or **Cancel**.

Note: To delete an existing app, hover over the line containing the listing and then click the trash can icon on the right-hand side. A confirmation dialog box appears. Click **Delete** to delete the listing or **Cancel** to keep the listing.

To edit an existing app, hover over the line containing the listing and then click the pen icon on the right-hand side. Make any changes to the listing and then click **Save** to save the changed listing or **Cancel** to leave the listing unchanged.

8. Configure deployment rules and choose delivery groups. For more information, see [Add a device policy](#).

Credentials device policy

Jun 28, 2017

You can create credentials device policies in XenMobile to enable integrated authentication with your PKI configuration in XenMobile, such as a PKI entity, a keystore, a credential provider, or a server certificate. For more information about credentials, see [Certificates](#).

You can create credential policies for iOS, Mac OS X, Android, Android for Work, Windows desktop/tablet, Windows Mobile/CE, and Windows Phone devices. Each platform requires a different set of values, which are described in this article.

[iOS settings](#)

[Mac OS X settings](#)

[Android and Android for Work settings](#)

[Windows desktop/tablet settings](#)

[Windows Mobile/CE settings](#)

[Windows Phone settings](#)

Before you can create this policy, you need the credential information you plan to use for each platform, plus any certificates and passwords.

1. In the XenMobile console, click **Configure > Device Policies**. The **Device Policies** page appears.
 2. Click **Add**. The **Add New Policy** dialog box appears.
 3. Expand **More** and then, under **Security**, click **Credentials**. The **Credentials Policy** information page appears.
 4. In the **Policy Information** pane, type the following information:
 - **Policy Name**: Type a descriptive name for the policy.
 - **Description**: Type an optional description of the policy.
 5. Click **Next**. The **Policy Platforms** page appears.
 6. Under **Platforms**, select the platforms you want to add. If you are only configuring for one platform, clear the others.
- When you finish configuring the settings for a platform, refer to Step 7 for how to set that platform's deployment rules.

Configure iOS settings

Configure the following settings:

- **Credential type:** In the list, click the type of credential to use with this policy and then enter the following information for the selected credential:
 - **Certificate**
 - **Credential name:** Enter a unique name for the credential.
 - **The credential file path:** Select the credential file by clicking Browse and navigating to the file's location.
 - **Keystore**
 - **Credential name:** Enter a unique name for the credential.
 - **The credential file path:** Select the credential file by clicking Browse and navigating to the file's location.
 - **Password:** Enter the keystore password for the credential.
 - **Server certificate**
 - **Server certificate:** In the list, click the certificate to use.
 - **Credential provider**
 - **Credential provider:** In the list, click the name of the credential provider.
- **Policy Settings**
 - Next to **Remove policy**, click either **Select date** or **Duration until removal (in hours)**.
 - If you click **Select date**, click the calendar to select the specific date for removal.
 - In the **Allow user to remove policy list**, click **Always**, **Password required**, or **Never**.
 - If you click **Password required**, next to **Removal password**, type the necessary password.

Configure Mac OS X settings

Configure the following settings:

- **Credential type:** In the list, click the type of credential to use with this policy and then, enter the following information for the selected credential:
 - **Certificate**
 - **Credential name:** Enter a unique name for the credential.
 - **The credential file path:** Select the credential file by clicking **Browse** and navigating to the file's location.
 - **Keystore**
 - **Credential name:** Enter a unique name for the credential.
 - **The credential file path:** Select the credential file by clicking **Browse** and navigating to the file's location.
 - **Password:** Enter the keystore password for the credential.
 - **Server certificate**
 - **Server certificate:** In the list, click the certificate to use.
 - **Credential provider**
 - **Credential provider:** In the list, click the name of the credential provider.
- **Policy Settings**
 - Next to **Remove policy**, click either **Select date** or **Duration until removal (in hours)**.
 - If you click **Select date**, click the calendar to select the specific date for removal.
 - In the **Allow user to remove policy list**, click **Always**, **Password required**, or **Never**.
 - If you click **Password required**, next to **Removal password**, type the necessary password.
 - Next to **Policy scope**, click either **User** or **System**. The default is **User**. This option is available only on OS X 10.7 and later.

Configure Android and Android for Work settings

The screenshot shows the XenMobile configuration interface for a Credentials Policy. The top navigation bar includes 'XenMobile', 'Analyze', 'Manage', and 'Configure'. Below this, there are tabs for 'Device Policies', 'Apps', 'Actions', 'ShareFile', and 'Delivery Groups'. The left sidebar shows a tree view with 'Credentials Policy' selected, containing sections for '1 Policy Info', '2 Platforms', and '3 Assignment'. Under '2 Platforms', several operating systems are listed with checkboxes: iOS, Mac OS X, Android (highlighted), Android for Work, Windows Phone, Windows Desktop/Tablet, and Windows Mobile/CE. The main content area is titled 'Credentials Policy' and contains a description: 'This policy lets you deliver certificates to devices. On iOS, the certificates, such as a certificate for WiFi authentication, can also be used as part of another policy. For Windows Phone, the policy is supported only on Windows 10 and later supervised devices.' Below the description, there is a 'Credential type' dropdown menu set to 'Certificate (.cer, .crt, .der and .pem)'. Underneath, there is a text input field for 'The credential file path' and a green 'Browse' button. A 'Deployment Rules' section is visible below. At the bottom right of the main content area, there are 'Back' and 'Next >' buttons.

Configure the following settings:

- **Credential type:** In the list, click the type of credential to use with this policy and then, enter the following information for the selected credential:
 - **Certificate**
 - **Credential name:** Type a unique name for the credential.
 - **The credential file path:** Select the credential file by clicking Browse and then navigating to the file's location.
 - **Keystore**
 - **Credential name:** Type a unique name for the credential.
 - **The credential file path:** Select the credential file by clicking **Browse** and then navigating to the file location.
 - **Password:** Type the keystore password for the credential.
 - **Server certificate**
 - **Server certificate:** In the list, click the certificate to use.
 - **Credential provider**
 - **Credential provider:** In the list, click the name of the credential provider.

Configure Windows Desktop/Tablet settings

Credentials Policy

This policy lets you deliver certificates to devices. On iOS, the certificates, such as a certificate for WiFi authentication, can also be used as part of another policy. For Windows Phone, the policy is supported only on Windows 10 and later supervised devices.

OS version* 10

Certificate Type ROOT

Store device root

Location System

Credential type Certificate (.cer, .crt, .der and .pem)

Credential file path* **Browse**

► **Deployment Rules**

Back **Next >**

Configure the following settings:

OSVersion: In the list, click either **8.1** for Windows 8.1 or **10** for Windows 10. The default is **10**.

- **Certificate Type:** In the list, click either **ROOT** or **CLIENT**.
- If you click **ROOT**, configure these settings:
 - **Store device:** In the list, click **root**, **My**, or **CA** for the location of the certificate store for the credential. **My** stores the certificate in users' certificate stores.
 - **Location:** **System** is the only location for Windows 10 tablets.
 - **Credential type:** **Certificate** is the only credential type for Windows 10 tablets.
 - **Credential file path:** Select the certificate file by clicking **Browse** and navigating to the file's location.
- If you click **CLIENT**, configure these settings:
 - **Location:** **System** is the only location for Windows 10 tablets.
 - **Credential type:** **Keystore** is the only credential type for Windows 10 tablets.
 - **Credential name:** Type the name of the credential. This field is required.
 - **Credential file path:** Select the certificate file by clicking **Browse** and navigating to the file's location.
 - **Password:** Type the password associated with the credential. This field is required.

- **Store device:** In the list, click **root**, **My**, or **CA** for the location of the certificate store for the credential. **My** stores the certificate in users' certificate stores.
- **Location:** Device location, such as **System**.
- **Credential Type:** A type, such as **Certificate**.
- **The credential file path:** Select the credential file by clicking **Browse** and then navigating to the file location.

Configure Windows Mobile/CE settings

XenMobile Analyze Manage **Configure** admin

Device Policies Apps Actions ShareFile Delivery Groups

Credentials Policy

This policy lets you deliver certificates to devices. On iOS, the certificates, such as a certificate for WiFi authentication, can also be used as part of another policy. For Windows Phone, the policy is supported only on Windows 10 and later supervised devices.

Store device: root

Credential type: Certificate (.cer, .crt, .der and .pem)

Credential file path: **Browse**

► **Deployment Rules**

Back **Next >**

Configure the following settings:

- **Store device:** In the list, click the location of the certificate store for the credential. The default is **root**. Options are:
 - **Privileged execution trust authorities** - Applications signed with a certificate belonging to this store will run with privileged trust level.
 - **Unprivileged execution trust authorities** - Applications signed with a certificate belonging to this store will run with normal trust level.
 - **SPC (Software Publisher Certificate)** - The Software Publishing Certificate (SPC) is used for signing .cab files.
 - **root** - A certificate store that contains root, or self-signed, certificates.
 - **CA** - A certificate store that contains cryptographic information, including intermediary certification authorities.
 - **MY** - A certificate store that contains end-user personal certificates.
- **Credential type:** Certificate is the only credential type for Windows Mobile/CE devices.
- **The credential file path:** Select the credential file by clicking **Browse** and then navigating to the file's location.

Configure Windows Phone settings

Configure the following settings:

- **Certificate Type:** In the list, click either **ROOT** or **CLIENT**.
- If you click **ROOT**, configure these settings:
 - **Store device:** In the list, click **root**, **My**, or **CA** for the location of the certificate store for the credential. **My** stores the certificate in users' certificate stores.
 - **Location:** System is the only location for Windows phones.
 - **Credential type:** Certificate is the only credential type for Windows phones.
 - **Credential file path:** Select the certificate file by clicking **Browse** and navigating to the file's location.
- If you click **CLIENT**, configure these settings:
 - **Location:** **System** is the only location for Windows phones.
 - **Credential type:** **Keystore** is the only credential type for Windows phones.
 - **Credential name:** Type the name of the credential. This field is required.
 - **Credential file path:** Select the certificate file by clicking **Browse** and navigating to the file's location.
 - **Password:** Type the password associated with the credential. This field is required.

7. Configure deployment rules and choose delivery groups. For more information, see [Add a device policy](#).

Custom XML device policy

Jun 19, 2017

You can create custom XML policies in XenMobile to customize the following features on supported Windows and Zebra Android devices:

- Provisioning, which includes configuring the device, and enabling or disabling features
- Device configuration, which includes allowing users to change settings and device parameters
- Software upgrades, which include providing new software or bug fixes to be loaded onto the device, including apps and system software
- Fault management, which includes receiving error and status reports from the device

For Windows devices: You create your custom XML configuration by using the Open Mobile Alliance Device Management (OMA DM) API in Windows. Creating custom XML with the OMA DM API is beyond the scope of this topic. For more information about using the OMA DM API, see [OMA Device Management](#) on the Microsoft Developer Network site.

For Zebra Android devices: You create your custom XML configuration by using the MX Management System (MXMS). Creating custom XML with the MXMS API is beyond the scope of this article. For more information about using MXMS, see [About MX](#) on the Zebra site.

Note

For Windows 10 RS2 Phone: After a Custom XML policy or Restrictions policy that disables Internet Explorer deploys to the phone, the browser remains enabled. To work around this issue, restart the phone. This is a third-party issue.

1. In the XenMobile console, click **Configure > Device Policies**. The **Device Policies** page appears.
2. Click **Add**. The **Add New Policy** dialog box appears.
3. Expand **More** and then under **Custom**, click **Custom XML**. The **Custom XML Policy** information page appears.
4. In the **Policy Information** pane, enter the following information:
 - **Policy Name**: Type a descriptive name for the policy.
 - **Description**: Type an optional description of the policy.
5. Click **Next**. The **Policy Platforms** page appears.

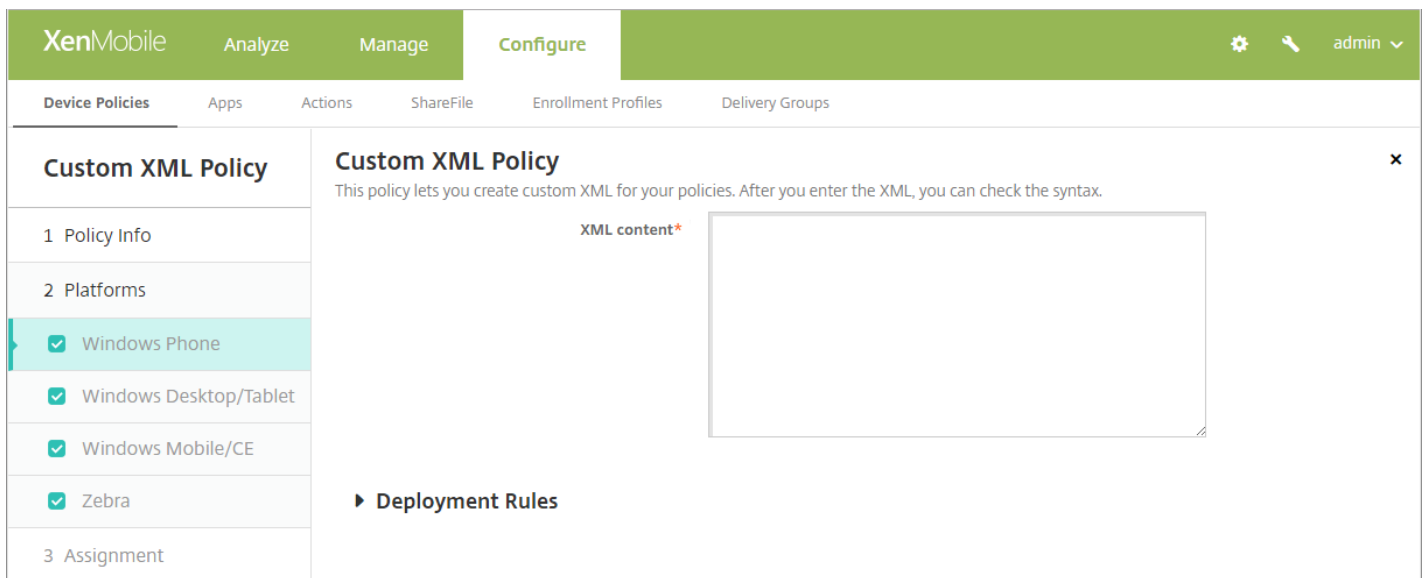

6. Under **Platforms**, select the platforms you want to add. If you are only configuring for one platform, clear the others.

7. Configure the following setting for each platform you selected:

- **XML content:** Type, or cut and paste, the custom XML code you want to add to the policy.

8. Configure deployment rules. For more information, see [Add a device policy](#).

9. Click **Next**. XenMobile checks the XML content syntax. Any syntax errors appear below the content box. Fix any errors before you continue.

If there are no syntax errors, the **Custom XML Policy** assignment page appears.

10. Next to **Choose delivery groups**, type to find a delivery group. Or, select a group or groups in the list to which you want to assign the policy. The groups you select appear in the **Delivery groups to receive app assignment** list.

11. Expand **Deployment Schedule** and then configure the following settings:

- Next to **Deploy**, click **ON** to schedule deployment or click **OFF** to prevent deployment. The default option is **ON**.
- Next to **Deployment schedule**, click **Now** or **Later**. The default option is **Now**.
- If you click **Later**, click the calendar icon and then select the date and time for deployment.
- Next to **Deployment condition**, click **On every connection** or click **Only when previous deployment has failed**. The default option is **On every connection**.
- Next to **Deploy for always-on connection**, click **ON** or **OFF**. The default option is **OFF**.

Note:

- This option applies when you have configured the scheduling background deployment key in **Settings > Server Properties**.
- The deployment schedule you configure is the same for all platforms. Any changes you make apply to all platforms.

12. Click **Save**.

Defender device policy

Jun 19, 2017

Windows Defender is malware protection included with Windows 10. You can use the XenMobile device policy, Defender, to configure the Microsoft Defender policy for Windows 10 for desktop and tablet.

1. In the XenMobile console, click **Configure > Device Policies**. The **Device Policies** page appears.
2. Click **Add**. The **Add a New Policy** dialog box appears.
3. Start typing **Defender** and then click that name in the search results. The **Defender Policy information** page appears.
4. In the **Policy Information** pane, type the following information:
 - **Policy Name:** Type a descriptive name for the policy.
 - **Description:** Optionally, type a description of the policy.
5. Click **Next**. The **Policy Platforms** page appears.

The screenshot shows the XenMobile console interface. At the top, there's a navigation bar with 'XenMobile', 'Analyze', 'Manage', and 'Configure' tabs. Below that, there's a sub-navigation bar with 'Device Policies', 'Apps', 'Actions', 'ShareFile', 'Enrollment Profiles', and 'Delivery Groups'. The main content area is titled 'Defender' and includes a sidebar on the left with '1 Policy Info', '2 Platforms', and '3 Assignment'. The 'Platforms' section is expanded to show 'Windows Desktop/Tablet' selected. The main content area shows various settings for Windows Defender, including 'Allows scanning of archives' (OFF), 'Allows cloud protection' (ON), 'Allows a full scan of removable drives' (ON), 'Allows Windows Defender Real-time Monitoring functionality' (ON), 'Allows scanning of network files' (ON), and 'Allows user access to the Windows Defender UI' (ON). There are also input fields for 'Excluded extensions', 'Excluded paths', and 'Excluded processes', and a dropdown for 'Submit samples consent' set to 'Send safe samples'.

Configure these settings:

- **Allows scanning of archives:** Allows or disallows Defender to scan archived files. Defaults to **OFF**.
- **Allows cloud protection:** Allows or disallows Defender to send information to Microsoft about malware activity. Defaults to **ON**.

- **Allows a full scan of removable drives:** Allows or disallows Defender to scan removable drives such as USB sticks. Defaults to **ON**.
- **Allows Windows Defender Real-time Monitoring functionality:** Defaults to **ON**.
- **Allows scanning of network files:** Allows or disallows Defender to scan network files. Defaults to **ON**.
- **Allows user access to the Windows Defender UI:** Specifies whether users can access the Windows Defender user interface. This setting takes effect the next time the user device starts. If this setting is **OFF**, users don't receive any Windows Defender notifications. Defaults to **ON**.
- **Excluded extensions:** The extensions to exclude from real-time or scheduled scans. To separate extensions, use the | character. For example, ".lib|.obj".
- **Excluded paths:** The paths to exclude from real-time or scheduled scans. To separate paths, use the | character. For example, "C:\Example|C:\Example1".
- **Excluded processes:** The processes to exclude from real-time or scheduled scans. To separate processes, use the | character. For example, "C:\Example.exe|C:\Example1.exe".
- **Submit samples consent:** Controls whether to send to Microsoft files that might require further analysis to determine if they are malicious. Options: **Always prompt**, **Send safe samples**, **Never send**, **Send all samples**. Defaults to **Send safe samples**.

7. Configure deployment rules and choose delivery groups. For more information, see [Add a device policy](#).

Delete files and folders device policy

Jun 19, 2017

You can create a policy in XenMobile to delete specific files or folders from Windows Mobile/CE devices.

1. In the XenMobile console, click **Configure > Device Policies**. The **Device Policies** page appears.
2. Click **Add**. The **Add New Policy** dialog box appears.
3. Expand **More** and then, under **Apps**, click **Delete Files and Folders**. The **Delete Files and Folders Policy** information page appears.
4. In the **Policy Information** pane, type the following information:
 - **Policy Name:** Type a descriptive name for the policy.
 - **Description:** Type an optional description of the policy.
5. Click **Next**. The **Windows Mobile/CE Platform** page appears.

The screenshot shows the XenMobile console interface. At the top, there are navigation tabs: 'XenMobile', 'Analyze', 'Manage', and 'Configure'. The 'Configure' tab is active. Below the navigation, there are sub-tabs: 'Device Policies', 'Apps', 'Actions', 'ShareFile', and 'Delivery Groups'. The 'Device Policies' sub-tab is selected. On the left, there is a sidebar with a tree view showing 'Delete Files and Folders Policy' expanded. The main content area is titled 'Delete Files and Folders Policy' and contains a 'Policy Information' section. The 'Policy Information' section has a description: 'This policy allows you to specify which files and folders need to be deleted.' Below this is a table for 'Files and folders to delete' with columns for 'Path*', 'Type', and 'Add'. There is also a 'Deployment Rules' section. At the bottom right, there are 'Back' and 'Next >' buttons.

6. Configure these settings:

- **Files and folders to delete:** for each file or folder you want to delete, click Add and then do the following:
 - **Path:** Type the path to the file or folder.
 - **Type:** In the list, click File or Folder. The default is File.
 - Click **Save** to save the file or folder, or click **Cancel** to not save the file or folder.

Note: To delete an existing listing, hover over the line containing the listing and then click the trash can icon on the right-hand side. A confirmation dialog box appears. Click **Delete** to delete the listing or **Cancel** to keep the listing.

To edit an existing listing, hover over the line containing the listing and then click the pen icon on the right-hand side. Make any changes to the listing and then click **Save** to save the changed listing or **Cancel** to leave the listing unchanged.

7. Configure deployment rules and choose delivery groups. For more information, see [Add a device policy](#).

Delete registry keys and values device policy

Jun 19, 2017

You can create a policy in XenMobile to delete specific registry keys and values from Windows Mobile/CE devices.

1. In the XenMobile console, click **Configure > Device Policies**. The **Device Policies** page appears.
2. Click **Add**. The **Add New Policy** dialog box appears.
3. Expand **More** and then, under **Apps**, click **Delete Registry Keys and Values**. The **Delete Registry Keys and Values Policy** information page appears.
4. In the **Policy Information** pane, type the following information:
 - **Policy Name:** Type a descriptive name for the policy.
 - **Description:** Type an optional description of the policy.
5. Click **Next**. The **Windows Mobile/CE Platform** page appears.

The screenshot shows the XenMobile console interface. At the top, there are navigation tabs: XenMobile, Analyze, Manage, and Configure. The 'Configure' tab is active. Below the navigation, there are sub-tabs: Device Policies, Apps, Actions, ShareFile, and Delivery Groups. The 'Device Policies' sub-tab is selected. On the left, there is a sidebar with the title 'Delete Registry Keys and Values Policy' and a list of steps: 1 Policy Info, 2 Platforms, 3 Assignment. The '2 Platforms' step is expanded, showing 'Windows Mobile/CE' selected with a checkmark. The main content area is titled 'Policy Information' and contains the following text: 'This policy allows you to specify which registry keys and values need to be deleted. An empty value means that the entry is a registry key.' Below this text is a table with the heading 'Registry keys and values to delete'. The table has two columns: 'Key*' and 'Value'. There is an 'Add' button to the right of the 'Value' column. Below the table is a section titled 'Deployment Rules'. At the bottom right of the page, there are 'Back' and 'Next >' buttons.

6. Configure these settings:

- **Registry keys and values to delete:** for each registry key and value you want to delete, click **Add** and then do the following:
 - **Key:** Type the registry key path. This is a required field. The registry key path should either start with HKEY_CLASSES_ROOT\ or HKEY_CURRENT_USER\ or HKEY_LOCAL_MACHINE\ or HKEY_USERS\.
 - **Value:** Type the value name to be deleted or leave this field blank to delete the entire registry key.
 - Click **Save** to save the key and value, or click **Cancel** to not save the key and value.

Note: To delete an existing listing, hover over the line containing the listing and then click the trash can icon on the right-hand side. A confirmation dialog box appears. Click **Delete** to delete the listing or **Cancel** to keep the listing.

To edit an existing listing, hover over the line containing the listing and then click the pen icon on the right-hand side. Make any changes to the listing and then click **Save** to save the changed listing or **Cancel** to leave the listing unchanged.

7. Configure deployment rules and choose delivery groups. For more information, see [Add a device policy](#).

Device Health Attestation device policy

Jun 19, 2017

In XenMobile, you can require Windows 10 devices to report the state of their health by having those devices send specific data and runtime information to the Health Attestation Service (HAS) for analysis. The HAS creates and returns a Health Attestation Certificate that the device then sends to XenMobile. When XenMobile receives the Health Attestation Certificate, based on the contents of the Health Attestation Certificate, it can deploy automatic actions that you have set up previously.

The data verified by the HAS are:

- AIK Present
- Bit Locker Status
- Boot Debugging Enabled
- Boot Manager Rev List Version
- Code Integrity Enabled
- Code Integrity Rev List Version
- DEP Policy
- ELAM Driver Loaded
- Issued At
- Kernel Debugging Enabled
- PCR
- Reset Count
- Restart Count
- Safe Mode Enabled
- SBCP Hash
- Secure Boot Enabled
- Test Signing Enabled
- VSM Enabled
- WinPE Enabled

For more information, refer to the Microsoft [HealthAttestation CSP](#) page.

1. In the XenMobile console, click **Configure > Device Policies**. The **Device Policies** page appears.
2. Click **Add** to add a new policy. The **Add a New Policy** dialog box appears.
3. Click **More**, and then under **Custom**, click **Device Health Attestation policy**. The **Device Health Attestation Policy** information page appears.
4. In the **Policy Information** pane, enter the following information:
 - **Policy Name:** Type a descriptive name for the policy.
 - **Description:** Type an optional description of the policy.
5. Click **Next**. The **Policy Platforms** page appears.
6. Under **Platforms**, select the platforms you want to add. If you are only configuring for one platform, clear the others.

When you finish configuring the settings for a platform, refer to Step 7 for how to set that platform's deployment rules.

The screenshot shows the XenMobile interface in the 'Configure' tab. The left sidebar contains a navigation menu with 'Device Policies' selected. Under 'Device Policies', there are sections for '1 Policy Info', '2 Platforms', and '3 Assignment'. The '2 Platforms' section is expanded, showing two checked items: 'Windows Phone' and 'Windows Desktop/Tablet'. The main content area is titled 'Device Health Attestation Policy' and includes a description: 'This policy enables Device Health Attestation, a security and data loss prevention (DLP) feature in Windows 10 that lets you determine the health of a Windows 10 device and take compliance actions when necessary.' Below the description is a toggle switch for 'Enable Device Health Attestation' which is currently turned 'ON'. A section for 'Deployment Rules' is visible below the toggle.

Configure this setting for each platform that you choose:

- **Enable Device Health Attestation:** Select whether to require Device Health Attestation. The default is **OFF**.

7. Configure deployment rules and choose delivery groups. For more information, see [Add a device policy](#).

Device name device policy

Jun 19, 2017

You can set the names on iOS and Mac OS X devices so that you can easily identify the devices. You can use macros, text, or a combination of both to define the device's name. For example, to set the device name as the serial number of the device, you would use `${device.serialnumber}`. To set the device name as a combination of the user's name and your domain, you would use `${user.username}@example.com`. See [Macros in XenMobile](#) for more information about macros.

1. In the XenMobile console, click **Configure > Device Policies**. The **Device Policies** page appears.
 2. Click **Add**. The **Add a New Policy** page appears.
 3. Expand **More**, and under **End User**, click **Device name**. The **Device Name Policy** information page appears.
 4. In the **Policy Information** pane, type the following information:
 - **Policy Name:** Type a descriptive name for the policy.
 - **Description:** Type an optional description of the policy.
 5. Click **Next**. The **Policy Platforms** page appears.
 6. Under **Platforms**, select the platforms you want to add. If you are only configuring for one platform, clear the others.
- When you finish configuring the settings for a platform, refer to Step 7 for how to set that platform's deployment rules.

Configure iOS and Mac OS X settings

The screenshot shows the XenMobile console interface. The top navigation bar includes 'XenMobile', 'Analyze', 'Manage', 'Configure', and a user profile 'admin'. The main content area is titled 'Device Name Policy' and contains a 'Policy Information' section with a description and a text input field for 'Device name'. Below this is a 'Deployment Rules' section. On the left, a sidebar shows '2 Platforms' with 'iOS' and 'Mac OS X' selected. At the bottom right, there are 'Back' and 'Next >' buttons.

Configure this setting for the platforms you choose:

- **Device name:** Type the macro, a combination of macros, or a combination of macros and text to name each device uniquely. For example, use `${device.serialnumber}` to set the device names to each device's serial number, or use `${device.serialnumber} ${user.username}` to include the user's name in the device name.

7. Configure deployment rules and choose delivery groups. For more information, see [Add a device policy](#).

Enterprise Hub device policy

Jun 19, 2017

An Enterprise Hub device policy for Windows Phone lets you distribute apps through the Enterprise Hub Company store.

Before you can create the policy, you need the following:

- An AET (.aetx) signing certificate from Symantec
- The Citrix Company Hub app signed by using the Microsoft app signing tool (XapSignTool.exe)

Note: XenMobile supports only one Enterprise Hub policy for one mode of Windows Phone Secure Hub. For example, to upload Windows Phone Secure Hub for XenMobile Enterprise Edition, you should not create multiple Enterprise Hub policies with different versions of Work Home for XenMobile Enterprise Edition. You can only deploy the initial Enterprise Hub policy during device enrollment.

1. In the XenMobile console, click **Configure > Device Policies**. The **Device Policies** page appears.
2. Click **Add**. The **Add a New Policy** dialog box appears.
3. Expand **More** and then, under **XenMobile agent**, click **Enterprise Hub**. The **Enterprise Hub Policy** page appears.
4. In the **Policy Information** pane, type the following information:
 - **Policy Name:** Type a descriptive name for the policy.
 - **Description:** Type an optional description of the policy.
5. Click **Next**. The **Windows Phone** platform page appears.

The screenshot shows the XenMobile console interface. At the top, there's a navigation bar with 'XenMobile', 'Analyze', 'Manage', 'Configure', and 'admin'. Below this, there's a sub-navigation bar with 'Device Policies', 'Apps', 'Actions', 'ShareFile', and 'Delivery Groups'. The main content area is titled 'Enterprise Hub Policy' and has a 'Policy Information' pane. The 'Policy Information' pane contains instructions: 'To create the Enterprise Hub policy for Windows Phone app distribution through the Enterprise Hub Company store, you need the AET (.aetx) signing certificate from Symantec. You also need to have obtained and signed the Citrix Company Hub app using the Microsoft app signing tool (XapSignTool.exe)'. Below this, there are two 'Upload' fields: 'Upload .aetx file' and 'Upload signed Enterprise Hub app', each with a 'Browse' button. The 'Deployment Rules' section is collapsed. The left sidebar shows 'Enterprise Hub Policy' with sections for '1 Policy Info', '2 Platforms' (where 'Windows Phone' is selected), and '3 Assignment'. At the bottom right, there are 'Back' and 'Next >' buttons.

6. Configure these settings:

- **Upload .aetx file:** Select the .aetx file by clicking **Browse** and navigating to the file's location.
- **Upload signed Enterprise Hub app:** Select the Enterprise Hub app by clicking **Browse** and navigating to the app's location.

7. Configure deployment rules and choose delivery groups. For more information, see [Add a device policy](#).

Files device policy

Jun 19, 2017

You can add script files to XenMobile that perform certain functions for users, or you can add document files that you want Android device users to be able to access on their devices. When you add the file, you can also specify the directory in which you want the file to be stored on the device. For example, if you want Android users to receive a company document or .pdf file, you can deploy the file to the device and let users know where the file is located.

You can add the following file types with this policy:

- Text-based files (.xml, .html, .py, and so on)
- Other files, such as documents, pictures, spreadsheets, or presentations
- For Windows Mobile and Windows CE only: Script files created with MortScript

1. In the XenMobile console, click **Configure > Device Policies**. The **Device Policies** page appears.

2. Click **Add**. The **Add a New Policy** dialog box appears.

3. Expand **More** and then, under **Apps**, click **Files**. The **Files Policy** information page appears.

4. In the **Policy Information** pane, enter the following information:

- **Policy Name:** Type a descriptive name for the policy.
- **Description:** Optionally, type a description of the policy.

5. Click **Next**. The **Policy Platforms** page appears.

The screenshot shows the XenMobile console interface for configuring a 'Files Policy'. The top navigation bar includes 'XenMobile', 'Analyze', 'Manage', and 'Configure'. Below this, there are tabs for 'Device Policies', 'Apps', 'Actions', 'ShareFile', and 'Delivery Groups'. The 'Files Policy' page is displayed, with a sidebar on the left containing sections for '1 Policy Info', '2 Platforms', and '3 Assignment'. Under '2 Platforms', 'Android' and 'Windows Mobile/CE' are selected. The main content area is titled 'Policy Information' and includes a description: 'This policy lets you upload files and executable scripts to devices.' The configuration fields are: 'File to be imported*' with a 'Browse' button; 'File type' with radio buttons for 'File' (selected) and 'Script'; 'Replace macro expressions' with a toggle set to 'OFF'; 'Destination folder' with a dropdown menu showing '%XenMobile Folder%'; 'Destination file name' with an empty text box; and a dropdown menu for 'Copy file only if different'. At the bottom, there is a 'Deployment Rules' section and 'Back' and 'Next >' buttons.

6. Under **Platforms**, select the platforms you want to add. If you are only configuring for one platform, clear the others. When you finish configuring the settings for a platform, refer to Step 7 for how to set that platform's deployment rules.

Configure Android settings

The screenshot shows the XenMobile Configure interface. The top navigation bar includes 'XenMobile', 'Analyze', 'Manage', and 'Configure'. Below this, there are tabs for 'Device Policies', 'Apps', 'Actions', 'ShareFile', and 'Delivery Groups'. The 'Files Policy' section is active, showing a sidebar with '1 Policy Info', '2 Platforms', and '3 Assignment'. Under '2 Platforms', 'Android' and 'Windows Mobile/CE' are checked. The main area is titled 'Policy Information' and contains the following settings:

- File to be imported***: A text input field with a 'Browse' button.
- File type**: Radio buttons for 'File' (selected) and 'Script'.
- Replace macro expressions**: A toggle switch set to 'OFF' with a help icon.
- Destination folder**: A dropdown menu showing '%XenMobile Folder%' with a help icon.
- Destination file name**: A text input field with a help icon.
- Copy file only if different**: A dropdown menu with 'Copy file only if different' selected.

At the bottom, there is a 'Deployment Rules' section and 'Back' and 'Next >' buttons.

Configure the following settings:

- **File to be imported:** Select the file to import by clicking Browse and navigating to the file's location.
- **File type:** Select either **File** or **Script**. When you select **Script**, **Execute immediately** appears. Select whether the script is executed as soon as the file is uploaded. The default is **OFF**.
- **Replace macro expressions:** Select whether to replace macro token names in a script with a device or user property. The default is **OFF**.
- **Destination folder:** In the list, select the location in which to store the uploaded file or click **Add new** to choose an unlisted file location. In addition, you can use the macros %XenMobile Folder%\ or %Flash Storage%\ as the start of a path identifier.
- **Destination file name:** Optionally, type a different name for the file if it must be changed before being deployed on a device.
- **Copy file only if different:** In the list, select whether to copy the file if it is different from the existing file. The default is to copy the file only if it is different.

Configure Windows Mobile/CE settings

The screenshot shows the 'Configure' page for a 'Files Policy' in XenMobile. The left sidebar has a 'Files Policy' section with sub-items: '1 Policy Info', '2 Platforms' (with 'Android' and 'Windows Mobile/CE' checked), and '3 Assignment'. The main area is titled 'Policy Information' and contains the following settings:

- File to be imported***: A text input field with a 'Browse' button.
- File type**: Radio buttons for 'File' (selected) and 'Script'.
- Replace macro expressions**: A toggle switch set to 'OFF' with a help icon.
- Destination folder**: A dropdown menu showing '%My Documents%'.
- Destination file name**: A text input field with a help icon.
- Copy file only if different**: A dropdown menu showing 'Copy file only if different'.
- Read only file**: A toggle switch set to 'OFF'.
- Hidden file**: A toggle switch set to 'OFF'.

At the bottom of the main area is a 'Deployment Rules' section with a right-pointing arrow. At the bottom right of the page are 'Back' and 'Next >' buttons.

Configure the following settings:

- **File to be imported:** Select the file to import by clicking Browse and navigating to the file's location.
- **File type:** Select either **File** or **Script**. When you select **Script**, **Execute immediately** appears. Select whether the script is executed as soon as the file is uploaded. The default is **OFF**.
- **Replace macro expressions:** Select whether to replace macro token names in a script with a device or user property. The default is **OFF**.
- **Destination folder:** In the list, select the location in which to store the uploaded file or click **Add new** to choose an unlisted file location. In addition, you can use any of the following macros as the start of a path identifier:
 - %Flash Storage%\
 - %XenMobile Folder%\
 - %Program Files%\
 - %My Documents%\
 - %Windows%\
- **Destination file name:** Optionally, type a different name for the file if it must be changed before being deployed on a device.
- **Copy file only if different:** In the list, select whether to copy the file if it is different from the existing file. The default is to copy the file only if it is different.
- **Read only file:** Select whether the file is to be read-only. The default is **OFF**.
- **Hidden file:** Select whether the file is not to be shown in the file list. The default is **OFF**.

7. Configure deployment rules and choose delivery groups. For more information, see [Add a device policy](#).

Font device policy

Jun 19, 2017

You can add a device policy in XenMobile to add additional fonts to users' iOS and Mac OS X devices. Fonts must be TrueType (.ttf) or OpenType (.oft) fonts. Font collections (.ttc or .otc) are not supported.

Note: For iOS, this policy applies only to iOS 7.0 and later.

1. In the XenMobile console, click **Configure > Device Policies**. The **Device Policies** page appears.

2. Click **Add**. The **Add a New Policy** dialog box appears.

3. Expand **More** and then, under **End user**, click **Font**. The **Font Policy** page appears.

4. In the **Policy Information** pane, enter the following information:

- **Policy Name:** Type a descriptive name for the policy.
- **Description:** Optionally, type a description of the policy.

5. Click **Next**. The **Platforms** page appears.

6. Under **Platforms**, select the platforms you want to add. If you are only configuring for one platform, clear the others.

When you finish configuring the settings for a platform, refer to Step 7 for how to set that platform's deployment rules.

Configure iOS setting

The screenshot shows the XenMobile console interface for configuring a Font Policy. The top navigation bar includes 'XenMobile', 'Analyze', 'Manage', and 'Configure'. Below this, there are tabs for 'Device Policies', 'Apps', 'Actions', 'ShareFile', and 'Delivery Groups'. The main content area is titled 'Font Policy' and is divided into three sections: '1 Policy Info', '2 Platforms', and '3 Assignment'. In the '2 Platforms' section, both 'iOS' and 'Mac OS X' are selected with checkmarks. The 'Policy Information' section contains the following fields and options:

- User-visible name:** A text input field with a help icon.
- Font file*:** A text input field with a 'Browse' button.
- Policy Settings:**
 - Remove policy:** Two radio button options: 'Select date' (selected) and 'Duration until removal (in days)'.
 - Duration until removal (in days):** A text input field with a calendar icon.
 - Allow user to remove policy:** A dropdown menu currently set to 'Always'.
- Deployment Rules:** A section header with a right-pointing arrow.

At the bottom right of the form, there are 'Back' and 'Next >' buttons.

Configure the following settings:

- **User-visible name:** Type the name that users see in their font lists.
- **Font file:** Select the font file to be added to users' devices by clicking **Browse** and then navigating to the file's location.
- **Policy Settings**
 - Next to **Remove policy**, click either **Select date** or **Duration until removal (in hours)**.
 - If you click **Select date**, click the calendar to select the specific date for removal.
 - In the **Allow user to remove policy** list, click **Always**, **Password required**, or **Never**.
 - If you click **Password required**, next to **Removal password**, type the necessary password.

Configure Mac OS X settings

The screenshot shows the XenMobile configuration interface for a Font Policy. The top navigation bar includes 'XenMobile', 'Analyze', 'Manage', and 'Configure'. Below this, there are tabs for 'Device Policies', 'Apps', 'Actions', 'ShareFile', and 'Delivery Groups'. The 'Font Policy' section is active, showing a sidebar with '1 Policy Info', '2 Platforms' (with 'iOS' and 'Mac OS X' selected), and '3 Assignment'. The main content area is titled 'Policy Information' and includes a description: 'This policy lets you add additional fonts to an iOS and Mac OS X device. The policy is available on iOS 7 and later devices.' The 'Policy Settings' section contains the following fields: 'User-visible name' (text input), 'Font file*' (text input with a 'Browse' button), 'Remove policy' (radio buttons for 'Select date' and 'Duration until removal (in days)'), 'Allow user to remove policy' (dropdown menu set to 'Always'), and 'Profile scope' (dropdown menu set to 'User'). The 'OS X 10.7+' version is indicated. At the bottom right, there are 'Back' and 'Next >' buttons.

Configure the following settings:

- **User-visible name:** Type the name that users see in their font lists.
- **Font file:** Select the font file to be added to users' devices by clicking **Browse** and then navigating to the file's location.
- **Policy Settings**
 - Next to **Remove policy**, click either **Select date** or **Duration until removal (in hours)**.
 - If you click **Select date**, click the calendar to select the specific date for removal.
 - In the **Allow user to remove policy** list, click **Always**, **Password required**, or **Never**.
 - If you click **Password required**, next to **Removal password**, type the necessary password.
 - Next to **Profile scope**, click either **User** or **System**. The default is **User**. This option is available only on OS X 10.7 and later.

7. Configure deployment rules and choose delivery groups. For more information, see [Add a device policy](#).

Home screen layout device policy

Jun 19, 2017

You can specify the layout of apps and folders for the iOS Home screen. The Home screen layout device policy is for iOS 9.3 and later supervised devices.

Note

Deploying multiple Home Screen Layout policies to a device results in an iOS error on the device. This limitation applies whether you define the home screen through this XenMobile policy or through the Apple Configurator.

1. In the XenMobile console, click **Configure > Device Policies**. The **Device Policies** page appears.
2. Click **Add**. The **Add a New Policy** dialog box appears.
3. Start typing **Home Screen Layout** and then click that name in the search results. The **Home Screen Layout Policy information** page appears.
4. In the **Policy Information** pane, type the following information:
 - **Policy Name:** Type a descriptive name for the policy.
 - **Description:** Optionally, type a description of the policy.
5. Click **Next**. The **iOS** pane appears.

XenMobile Analyze Manage **Configure** administrator

Device Policies Apps Actions ShareFile Enrollment Profiles Delivery Groups

Home Screen Layout Policy

This policy defines a layout of apps and folders for the home screen. It is supported only on iOS 9.3 and later supervised devices. For an application you should enter the bundle identifier as value. For a folder, you should enter a list of bundle identifiers separated with a comma.

1 Policy Info

2 Platforms

iOS

3 Assignment

Home Screen Layout Policy

Dock

Type	Display Name*	Value*	Add
			+ Add

Page 1

Type	Display Name*	Value*	Add
			+ Add

Page 2

Type	Display Name*	Value*	Add
			+ Add

Page 3

Type	Display Name*	Value*	Add
			+ Add

Page 4

Type	Display Name*	Value*	Add
			+ Add

Page 5

Type	Display Name*	Value*	Add
			+ Add

Policy Settings

Remove policy Select date Duration until removal (in days)

Allow user to remove policy

6. Configure the settings:

- For each of the screen areas you want to configure (such as **Dock** or **Page 1**), click **Add**.
- **Type**: Choose either **Application** or **Folder**.

XenMobile Analyze Manage **Configure** administrator

Device Policies Apps Actions ShareFile Enrollment Profiles Delivery Groups

Home Screen Layout Policy

This policy defines a layout of apps and folders for the home screen. It is supported only on iOS 9.3 and later supervised devices. For an application you should enter the bundle identifier as value. For a folder, you should enter a list of bundle identifiers separated with a comma.

1 Policy Info

2 Platforms

iOS

3 Assignment

Home Screen Layout Policy

Dock

Type	Display Name*	Value*	Save	Cancel
Application	<input type="text"/>	<input type="text"/>	Save	Cancel

Page 1

Type	Display Name*	Value*	Add
			+ Add

- **Display Name:** The name to appear on the home screen for the app or folder.
- **Value:** For apps, the bundle identifier. For folders, a list of bundle identifiers, separated by commas.

Policy Settings

- **Remove policy:** Either choose **Select date** and choose a date from the calendar, or choose **Duration until removal** and specify the number of days.
- **Allow user to remove policy:** Specify when to allow a user to remove the home screen definition: **Always**, **Passcode required** (only if they provide a passcode), or **Never**.

7. Configure deployment rules and choose delivery groups. For more information, see [Add a device policy](#).

Import iOS & Mac OS X Profile device policy

Jun 19, 2017

You can import device configuration XML files for iOS and OS X devices into XenMobile. The file contains device security policies and restrictions that you prepare with the Apple Configurator.

You can place an iOS device in Supervised mode with the Apple Configurator, as described later in this article. For more information about using the Apple Configurator to create a configuration file, see the Apple [Configurator Help](#) page.

1. In the XenMobile console, click **Configure > Device Policies**.
2. Click **Add**. The **Add a New Policy** dialog box appears.
3. Expand **More**, and then under **Custom**, click **Import iOS & Mac OS X Profile**. The **Import iOS & Mac OS X Profile Policy** information page appears.
4. On the **Policy Information** pane, enter the following information:
 - **Policy Name:** Type a descriptive name for the policy.
 - **Description:** Type an optional description of the policy.
5. Click **Next**. The **Policy Platforms** page appears.

The screenshot shows the XenMobile console interface. The top navigation bar includes 'XenMobile', 'Analyze', 'Manage', 'Configure', and 'admin'. Below this, there are tabs for 'Device Policies', 'Apps', 'Actions', 'ShareFile', and 'Delivery Groups'. The main content area is titled 'Import iOS & Mac OS X Profile Policy' and 'Policy Information'. The description states: 'This policy lets you import a device configuration XML file for either iOS or OS X. The file contains device security policies and restrictions that you prepare with the Apple Configurator.' There is a text input field for 'iOS configuration profile' and a 'Browse' button. Below this is a 'Deployment Rules' section. On the left, there is a sidebar with 'Import iOS & Mac OS X Profile Policy' and three sections: '1 Policy Info', '2 Platforms', and '3 Assignment'. Under '2 Platforms', 'iOS' and 'Mac OS X' are both checked. At the bottom right, there are 'Back' and 'Next >' buttons.

6. Under **Platforms**, select the platforms you want to add. If you are only configuring for one platform, clear the others.

When you finish configuring the settings for a platform, refer to Step 8 for how to set that platform's deployment rules.

7. Configure this setting for each platform you selected:

- **iOS configuration profile** or **Mac OS X configuration profile**: Select the configuration file to import by clicking **Browse** and navigating to the file's location.

7. Configure deployment rules and choose delivery groups. For more information, see [Add a device policy](#).

Place an iOS device in Supervised mode with the Apple Configurator

To use the Apple Configurator, you need an Apple computer running OS X 10.7.2 or later.

Important

Placing a device into Supervised mode will install the selected version of iOS on the device, completely wiping the device of any previously stored user data or apps.

1. Install the [Apple Configurator](#) from iTunes.
2. Connect the iOS device to your Apple computer.
3. Start the Apple Configurator. The Configurator shows that you have a device to prepare for supervision.
4. To prepare the device for supervision:
 - a. Switch the **Supervision** control to **On**. Citrix recommends that you choose this setting if you intend to maintain control of the device on an ongoing basis by reapplying a configuration regularly.
 - c. Optionally, provide a name for the device.
 - c. In iOS, click **Latest** for the latest version of iOS you want to install.
5. When you are ready to prepare the device for supervision, click **Prepare**.

Kiosk device policy for Samsung SAFE

Jun 19, 2017

You create a Kiosk policy in XenMobile to let you to specify that only a specific app or apps can be used on Samsung SAFE devices. This policy is useful for corporate devices that are designed to run only a specific type or class of apps. This policy also lets you choose custom images for the device home screen and lock screen wallpapers for when the device is in Kiosk mode.

To put a Samsung SAFE device into Kiosk mode

1. Enable the Samsung SAFE API key on the mobile device, as described in [Samsung MDM license key device policies](#). This step lets you enable policies on Samsung SAFE devices.
2. Enable the Connection Scheduling Policy for Android devices, as described in [Connection scheduling device policies](#). This step enables Android devices connect back to XenMobile.
3. Add a Kiosk device policy, as described in the next section.
4. Assign those three device policies to the appropriate delivery groups. Consider whether you want to include other policies, such as App inventory, in those delivery groups.

To remove the devices from Kiosk mode, create a Kiosk device policy that has **Kiosk mode** set to **Disable**. Update the delivery groups to remove the Kiosk policy that enabled Kiosk mode and to add the Kiosk policy that disables Kiosk mode.

To add a Kiosk device policy

Note:

- All apps that you specify for Kiosk mode must already be installed on the user devices.
- Some options apply only to the Samsung Mobile Device Management (MDM) API 4.0 and later.

1. In the XenMobile console, click **Configure > Device Policies**. The **Device Policies** page appears.
2. Click **Add**. The **Add a New Policy** dialog box appears.
3. Expand **More** and then, under **Security**, click **Kiosk**. The **Kiosk Policy** page appears.
4. In the **Policy Information** pane, type the following information:
 - **Policy Name:** Type a descriptive name for the policy.
 - **Description:** Type an optional description of the policy.
5. Click **Next**. The **Samsung SAFE Platform** information page appears.

The screenshot shows the XenMobile 'Configure' page for a 'Kiosk Policy'. The left sidebar has 'Kiosk Policy' selected, with sub-items for '1 Policy Info', '2 Platforms', '3 Assignment', and 'Samsung SAFE' (checked). The main area is titled 'Kiosk Policy' and includes a description: 'This policy lets you activate Kiosk mode on an Android device, in which only a specific app or apps can run on the device.' Below this is a 'General' section with the following settings:

- Kiosk mode:** Radio buttons for 'Enable' (selected) and 'Disable'.
- Launcher package:** A text input field.
- Emergency phone number:** A text input field containing 'a', with 'MDM 4.0+' to its right.
- Allow navigation bar:** Toggle switch set to 'ON', with 'MDM 4.0+' to its right.
- Allow multi-window mode:** Toggle switch set to 'ON', with 'MDM 4.0+' to its right.
- Allow status bar:** Toggle switch set to 'OFF', with 'MDM 4.0+' to its right.
- Allow system bar:** Toggle switch set to 'ON'.
- Allow task manager:** Toggle switch set to 'ON', with an information icon to its right.
- Change Common SAFE passcode:** Toggle switch set to 'OFF'.
- Common SAFE passcode:** A masked text input field showing '*****'.

Below the 'General' section are sections for 'Wallpapers' and 'Apps':

- Wallpapers:**
 - Define a home wallpaper:** Toggle switch set to 'OFF'.
 - Define a lock wallpaper:** Toggle switch set to 'OFF', with 'MDM 4.0+' to its right.
- Apps:** (Section header, no settings visible)

6. Configure these settings:

- **Kiosk mode:** Click **Enable** or **Disable**. The default is **Enable**. When you click **Disable**, all the following options disappear.
- **Launcher package:** Citrix recommends that you leave this field blank unless you have developed an in-house launcher to enable users to open the Kiosk app or apps. If you use an in-house launcher, enter the full name of the launcher application package.
- **Emergency phone number:** Enter an optional phone number. Anyone can use this number to contact your company to find a lost device. Applies only to MDM 4.0 and later.
- **Allow navigation bar:** Select whether to let users see and use the navigation bar while in Kiosk mode. Applies only to MDM 4.0 and later. The default is **ON**.
- **Allow multi-window mode:** Select whether to let users use multiple windows while in Kiosk mode. Applies only to MDM 4.0 and later. The default is **ON**.
- **Allow status bar:** Select whether to let users see the status bar while in Kiosk mode. Applies only to MDM 4.0 and later. The default is **ON**.
- **Allow system bar:** Select whether to let users see the system bar while in Kiosk mode. The default is **ON**.
- **Allow task manager:** Select whether to let users see and use the task manager while in Kiosk mode. The default is **ON**.
- **Change Common SAFE passcode:** This setting helps protect against inadvertent changes to the Common SAFE passcode field. When this setting is **OFF**, you can't change the Common SAFE passcode field. The default is **OFF**.
- **Common SAFE passcode:** If you set a general passcode policy for all Samsung SAFE devices, enter that optional passcode in this field.
- **Wallpapers**

- **Define a home wallpaper:** Select whether to use a custom image for the home screen while in Kiosk mode. The default is **OFF**.
 - **Home image:** When you enable **Define a home wallpaper**, select the image file by clicking **Browse** and navigating to the file location.
- **Define a lock wallpaper:** Select whether to use a custom image for the lock screen while in Kiosk mode. The default is **OFF**. Applies only to MDM 4.0 and later.
 - **Lock image:** When you enable **Define a lock wallpaper**, select the image file by clicking **Browse** and navigating to the file location.
- **Apps:** For each app that you want to add to Kiosk mode, click **Add** and then do the following:
 - **New app to add:** Enter the full name of the app to add. For example, com.android.calendar lets users use the Android calendar app.
 - Click **Save** to add the app or click **Cancel** to cancel adding the app.

Note: To delete an existing app, hover over the line containing the listing and then click the trash icon on the right side. A confirmation dialog box appears. Click **Delete** to delete the listing or **Cancel** to keep the listing.

To edit an existing app, hover over the line containing the listing and then click the pen icon on the right side. Update the listing and then click **Save**. Or, click **Cancel** to leave the listing unchanged.

7. Configure deployment rules and choose delivery groups. For more information, see [Add a device policy](#).

Launcher configuration device policy for Android

Jun 19, 2017

Citrix Launcher lets you customize the user experience for Android devices deployed by XenMobile. You can add a Launcher Configuration policy to control these Citrix Launcher features:

- Manage Android devices so that users can access only the apps that you specify.
- Optionally specify a custom logo image for the Citrix Launcher icon and a custom background image for Citrix Launcher.
- Specify a password that users must enter to exit the launcher.

While Citrix Launcher enables you to apply those device-level restrictions, the launcher grants users the operational flexibility they need through built-in access to device settings such as WiFi settings, Bluetooth settings, and device passcode settings. Citrix Launcher isn't intended as an extra layer of security over what the device platform already provides.

After you deploy Citrix Launcher, XenMobile installs it, replacing the default Android launcher.

1. In the XenMobile console, click **Configure > Device Policies**. The **Device Policies** page appears.
2. Click **Add**. The **Add a New Policy** dialog box appears.
3. Start typing **Launcher** and then select **Launcher Configuration** from the list. The **Launcher Configuration Policy** page appears.
4. In the **Policy Information** pane, enter the following information:
 - **Policy Name:** Type a descriptive name for the policy.
 - **Description:** Optionally, type a description of the policy.
5. Click **Next**. The **Android Platform** information page appears.

Launcher Configuration Policy

1 Policy Info

2 Platforms

Android

3 Assignment

Policy Information

This policy lets you define a configuration of an Android device launcher.

Launcher app configuration

Define a logo image

Logo image

Define a background image

Background image

Allowed apps

App name	Package Name*	<input type="button" value="Add"/>
test	test.com	

Password

► **Deployment Rules**

6. Configure these settings:

- **Define a logo image:** Select whether to use a custom logo image for Citrix Launcher icon. The default is **OFF**.
- **Logo image:** When you enable **Define a logo image**, select the image file by clicking **Browse** and navigating to the file's location. Supported file types are PNG, JPG, JPEG, and GIF.
- **Define a background image:** Select whether to use a custom image for the Citrix Launcher background. The default is **OFF**.
- **Background image:** When you enable **Define a background image**, select the image file by clicking **Browse** and navigating to the file's location. Supported file types are PNG, JPG, JPEG, and GIF.
- **Allowed apps:** For each app that you want to allow in Citrix Launcher, click **Add** and then do the following:
 - **New app to add:** Enter the full name of the app to add. For example, com.android.calendar for the Android calendar app.
 - Click **Save** to add the app or click **Cancel** to cancel adding the app.

Note: To delete an existing app, hover over the line containing the listing and then click the trash can icon on the right side. A confirmation dialog box appears. Click **Delete** to delete the listing or **Cancel** to keep the listing.

To edit an existing app, hover over the line containing the listing and then click the pen icon on the right side. Make any changes to the listing and then click **Save** to save the changed listing or **Cancel** to leave the listing unchanged.

- **Password:** The password a user must enter to exit Citrix Launcher.

7. Configure deployment rules and choose delivery groups. For more information, see [Add a device policy](#).

LDAP device policy

Jun 19, 2017

You create an LDAP policy for iOS devices in XenMobile to provide information about an LDAP server to use, including any necessary account information. The policy also provides a set of LDAP search policies to use when querying the LDAP server.

You need the LDAP host name before configuring this policy.

[iOS settings](#)

[Mac OS X settings](#)

1. In the XenMobile console, click **Configure > Device Policies**. The **Device Policies** page appears.
2. Click **Add** to add a policy. The **Add a New Policy** dialog box appears.
3. Expand **More** and then, under **End user**, click **LDAP**. The **LDAP Policy** page appears.
4. In the **Policy Information** pane, enter the following information:
 - **Policy Name:** Type a descriptive name for the policy.
 - **Description:** Optionally, type a description of the policy.
5. Click **Next**. The **Policy Platforms** information page appears.
6. Under **Platforms**, select the platforms you want to add. If you are only configuring for one platform, clear the others.

When you finish configuring the settings for a platform, refer to Step 7 for how to set the deployment rules.

Configure iOS settings

Configure the following settings:

- **Account description:** Enter an optional account description.
- **Account user name:** Enter an optional user name.
- **Account password:** Enter an optional password. Use this field only with encrypted profiles.
- **LDAP host name:** Enter the LDAP server host name. This field is required.
- **Use SSL:** Select whether to use a Secure Socket Layer connection to the LDAP server. The default is **ON**.
- **Search Settings:** Add search settings to use when querying the LDAP server. You can enter as many search settings as you want, but you should add at least one search setting to make the account useful. Click **Add** and then do the following:
 - **Description:** Enter a description of the search setting. This field is required.
 - **Scope:** Choose **Base**, **One level**, or **Subtree** to define how deeply into the LDAP tree to search. The default is **Base**.
 - **Base** searches the node pointed to by Search base.
 - **One level** searches the Base node and one level below it.
 - **Subtree** searches the Base node, plus all its children, regardless of depth.
 - **Search base:** Enter the path to the node at which to start searching. For example, ou=people or O=example corp. This field is required.
 - Click **Save** to add the search setting or click **Cancel** to cancel adding the search setting.
 - Repeat these steps for each search setting that you want to add.

Note: To delete the search setting, hover over the line containing the listing and click the trash icon on the right side. A confirmation dialog box appears. Click Delete to delete the listing or Cancel to keep the listing.

To edit a search setting, hover over the line containing the listing and click the pen icon on the right side. Update the listing and then click **Save**. Or, click **Cancel** to leave the listing unchanged.

- Under **Policy Settings**, next to **Remove policy**, click either **Select date** or **Duration until removal (in hours)**.
- If you click **Select date**, click the calendar to select the specific date for removal.
- In the **Allow user to remove policy** list, click **Always**, **Password required**, or **Never**.
- If you click **Password required**, next to **Removal password**, type the necessary password.

Configure Mac OS X settings

The screenshot shows the XenMobile Configure interface for an LDAP Policy. The left sidebar has a 'Mac OS X' section selected. The main area is titled 'Policy Information' and contains several configuration sections:

- Account Information:** Fields for Account description, Account user name, Account password, and LDAP host name*.
- Use SSL:** A toggle switch currently set to 'ON'.
- Search Settings:** A table with columns for Description*, Scope, and Search base*, plus an 'Add' button.
- Policy Settings:** Includes 'Remove policy' options (Select date selected, Duration until removal (in days)), 'Allow user to remove policy' (set to Always), and 'Profile scope' (set to User).
- Deployment Rules:** A section for OS X 10.7+.

Navigation buttons 'Back' and 'Next >' are located at the bottom right.

Configure the following settings:

- **Account description:** Enter an optional account description.
- **Account user name:** Enter an optional user name.
- **Account password:** Enter an optional password. Use this field only with encrypted profiles.
- **LDAP host name:** Enter the LDAP server host name. This field is required.
- **Use SSL:** Select whether to use a Secure Socket Layer connection to the LDAP server. The default is **ON**.

- **Search Settings:** Add search settings to use when querying the LDAP server. You can enter as many search settings as you want, but you should add at least one search setting to make the account useful. Click **Add** and then do the following:
 - **Description:** Enter a description of the search setting. This field is required.
 - **Scope:** Choose **Base**, **One level**, or **Subtree** to define how deeply into the LDAP tree to search. The default is **Base**.
 - **Base** searches the node pointed to by Search base.
 - **One level** searches the Base node and one level below it.
 - **Subtree** searches the Base node, plus all its children, regardless of depth.
 - **Search base:** Enter the path to the node at which to start searching. For example, ou=people or O=example corp. This field is required.
 - Click **Save** to add the search setting or click **Cancel** to cancel adding the search setting.
 - Repeat these steps for each search setting you want to add.

Note: To delete an existing search setting, hover over the line containing the listing and click the trash icon on the right side. A confirmation dialog box appears. Click **Delete** to delete the listing or **Cancel** to keep the listing.

To edit an existing search setting, hover over the line containing the listing and click the pen icon on the right side. Update the listing and then click **Save** to save the changed listing or **Cancel** to leave the listing unchanged.

- Under **Policy Settings**, next to **Remove policy**, click either **Select date** or **Duration until removal (in hours)**.
- If you click **Select date**, click the calendar to select the specific date for removal.
- In the **Allow user to remove policy** list, click **Always**, **Password required**, or **Never**.
- If you click **Password required**, next to **Removal password**, type the necessary password.
- In **Profile scope**, click either **User** or **System**. The default is **User**. This option is available only on OS X 10.7 and later.

7. Configure deployment rules and choose delivery groups. For more information, see [Add a device policy](#).

Location device policy

Jun 19, 2017

You create location device policies in XenMobile to enforce geographic boundaries. When users breach the defined boundary, also called a *geofence*, XenMobile can perform certain actions. For example, you can configure the policy to issue a warning message to users when they breach the defined perimeter. You can also configure the policy to wipe users' corporate data when they breach a perimeter, right away or after a delay. For information about security actions, such as enabling tracking and locating a device, see the Perform Security Actions section in [Devices](#).

You can create location device policies for iOS and Android. Each platform requires a different set of values, which are described in this article.

1. In the XenMobile console, click **Configure > Device Policies**. The **Device Policies** page appears.

2. Click **Add**. The **Add a New Policy** dialog box appears.

3. Click **Location**. The **Location Policy** information page appears.

4. In the **Policy Information** pane, enter the following information:

- **Policy Name:** Type a descriptive name for the policy.
- **Description:** Type an optional description of the policy.

5. Click **Next**. The **Platforms** page appears.

6. Under **Platforms**, select the platforms you want to add. If you are only configuring for one platform, clear the others.

When you finish configuring the settings for a platform, refer to Step 7 for how to set that platform's deployment rules.

Configure iOS settings

Configure these settings:

- **Location timeout:** Type a numeral and then, in the list, click **Seconds** or **Minutes** to set how often XenMobile attempts to fix the device's location. Valid values are 60-900 seconds or 1-15 minutes. The default is 1 minute.
- **Tracking duration:** Type a numeral and then, in the list, click **Hours** or **Minutes** to set how long XenMobile tracks the device. Valid values are 1-6 hours or 10-360 minutes. The default is 6 hours.
- **Accuracy:** Type a numeral and then, in the list, click **Meters**, **Feet**, or **Yards** to set how close to a device XenMobile tracks the device. Valid values are 10-5000 yards or meters, or 30-15000 feet. The default is 328 feet.
- **Report if Location Services are disabled:** Select whether the device sends a report to XenMobile when GPS is disabled. The default is **OFF**.
- **Geofencing**

When you enable Geofencing, configure these settings:

- **Radius:** Type a numeral and then, in the list, click the units to be used to measure the radius. The default is 16,400 feet. Valid values for radius are:
 - 164-164000 feet
 - 50-50000 meters
 - 54-54680 yards
 - 1-31 miles
- **Center point latitude:** Type a latitude, such as 37.787454, to define the geofence center point's latitude.
- **Center point longitude:** Type a longitude, such as 122.402952, to define the geofence center point's longitude.
- **Warn user on perimeter breach:** Select whether to issue a warning message when users breach the defined perimeter. The default is **OFF**. No connection to XenMobile is required to display the warning message.
- **Wipe corporate data on perimeter breach:** Select whether to wipe users' devices when they breach the perimeter. The default is **OFF**. When you enable this option, the **Delay on local wipe field** appears.
 - Type a numeral and then, in the list, click **Seconds** or **Minutes** to set the length of time to delay before wiping corporate data from users' devices. This gives users an opportunity to return to the allowed location before XenMobile selectively wipes their devices. The default is 0 seconds.

Configure Android settings

The screenshot shows the XenMobile web interface. The top navigation bar includes 'XenMobile', 'Analyze', 'Manage', and 'Configure'. The 'Configure' section is active, with sub-tabs for 'Device Policies', 'Apps', 'Actions', 'ShareFile', and 'Delivery Groups'. The 'Location Policy' page is displayed, with a left sidebar containing '1 Policy Info', '2 Platforms', and '3 Assignment'. Under '2 Platforms', 'iOS' and 'Android' are listed, with 'Android' selected. The main content area is titled 'Policy Information' and contains the following settings:

- Device agent configuration**
 - Poll interval: 10 (input field) and Minutes (dropdown menu)
 - Report if Location Services is disabled: OFF (toggle)
 - Geofencing: OFF (toggle)
- Deployment Rules** (expandable section)

At the bottom right, there are 'Back' and 'Next >' buttons.

- **Poll interval:** Type a numeral and then, in the list, click **Minutes** or **Hours**, or **Days** to set how often XenMobile attempts to fix the device's location. Valid values are 1-1440 minutes, 1-24 hours, or any number of days. The default is 10 minutes. Setting this value to less than 10 minutes may adversely affect the device's battery life.
- **Report if Location Services are disabled:** Select whether the device sends a report to XenMobile when GPS is disabled. The default is **OFF**.
- **Geofencing**

Geofencing

Radius

Center point latitude*

Center point longitude*

Warn user on perimeter breach ?

Device connects to XenMobile for policy refresh

- Perform no action on perimeter breach
- Wipe corporate data on perimeter breach
- Lock device locally

When you enable Geofencing, configure these settings:

- **Radius:** Type a numeral and then, in the list, click the units to be used to measure the radius. The default is 16,400 feet. Valid values for radius are:
 - 164-164000 feet
 - 1-50 kilometers
 - 50-50000 meters
 - 54-54680 yards
 - 1-31 miles
- **Center point latitude:** Type a latitude, such as 37.787454, to define the geofence center point's latitude.
- **Center point longitude:** Type a longitude, such as 122.402952, to define the geofence center point's longitude.
- **Warn user on perimeter breach:** Select whether to issue a warning message when users breach the defined perimeter. The default is **OFF**. No connection to XenMobile is required to display the warning message.
- **Device connects to XenMobile for policy refresh:** Select one of the following options for when users breach the perimeter:
 - **Perform no action on perimeter breach:** Do nothing. This is the default.
 - **Wipe corporate data on perimeter breach:** Wipe corporate data after a specified length of time. When you enable this option, the **Delay on local wipe** field appears.
 - Type a numeral and then, in the list, click Seconds or Minutes to set the length of time to delay before wiping corporate data from users' devices. This gives users an opportunity to return to the allowed location before XenMobile selectively wipes their devices. The default is 0 seconds.
 - **Delay on lock:** Lock users' devices after a specified length of time. When you enable this option, the **Delay on lock field** appears.
 - Type a numeral and then, in the list, click Seconds or Minutes to set the length of time to delay before locking users' devices. This gives users an opportunity to return to the allowed location before XenMobile locks their devices. The default is 0 seconds.

7. Configure deployment rules and choose delivery groups. For more information, see [Add a device policy](#).

Mail device policy

Jun 19, 2017

You can add a mail device policy in XenMobile to configure an email account on iOS or macOS devices.

1. In the XenMobile console, click **Configure > Device Policies**. The **Device Policies** page appears.
2. Click **Add** to add a policy. The **Add a New Policy** dialog box appears.
3. Click **More** and then, under **End user**, click **Mail**. The **Mail Policy** page appears.
4. In the **Policy Information** pane, enter the following information:
 - **Policy Name:** Type a descriptive name for the policy.
 - **Description:** Optionally, type a description of the policy.
5. Click **Next**. The **Mail Policy Platforms** page appears.

XenMobile Analyze Manage **Configure** administrator

Device Policies Apps Actions ShareFile Enrollment Profiles Delivery Groups

Mail Policy

This configuration allows you to set email parameters. Note that when applied to a supervised device, you need to configure Email address and User name fields.

1 Policy Info

2 Platforms

- iOS
- Mac OS X

3 Assignment

Account description*

Account type IMAP

Path prefix

User display name*

Email address*

Incoming email

Email server host name*

Email server port* 143

User name*

Authentication type Password

Password

Use SSL OFF

Outgoing email

Email server host name*

Email server port*

User name*

Authentication type Password

Password

Outgoing password same as incoming OFF

Use SSL OFF

Policy

Authorize email move between accounts OFF iOS 5.0+

Sending email only from mail app OFF iOS 5.0+

Disable mail recents syncing OFF iOS 6.0+

Allow Mail Drop OFF iOS 9.2+

Enable S/MIME OFF iOS 5.0+

Policy Settings

- Under **Platforms**, select the platforms you want to add. If you are only configuring for one platform, clear the others. When you finish configuring the settings for a platform, refer to Step 8 for how to set platform deployment rules.
- Configure the following settings for the platforms you selected.

- **Account description:** Type an account description that appears in the Mail and Settings apps. This field is required.
- **Account type:** Choose either **IMAP** or **POP** to select the protocol to be used for user accounts. The default is **IMAP**. When you select **POP**, the following **Path** prefix option disappears.
- **Path prefix:** Type **INBOX** or your IMAP mail account path prefix. This field is required.
- **User display name:** Type the full user name to be used for messages and other purposes. This field is required.
- **Email address:** Type the full email address for the account. This field is required.
- **Incoming email settings**
 - **Email server host name:** Type the incoming mail server host name or IP address. This field is required.
 - **Email server port:** Type the incoming mail server port number. The default is **143**. This field is required.
 - **User name:** Type the user name for the email account. This name is generally the same as the email address up to the @ character. This field is required.
 - **Authentication type:** Choose the authentication type to be used. The default is **Password**. When **None** is selected, the following **Password** field disappears.
 - **Password:** Type an optional password for the incoming mail server.
 - **Use SSL:** Select whether the incoming mail server uses Secure Socket Layer authentication. The default is **OFF**.
- **Outgoing email settings**
 - **Email server host name:** Type the outgoing mail server host name or IP address. This field is required.
 - **Email server port:** Type the outgoing mail server port number. If no port, you do not enter a port number, the default port for the given protocol is used.
 - **User name:** Type the user name for the email account. This name is generally the same as the email address up to the @ character. This field is required.
 - **Authentication type:** Choose the authentication type to use. The default is **Password**.
 - **Password:** Type an optional password for the outgoing mail server.
 - **Outgoing password same as incoming:** Select whether the incoming and outgoing passwords are the same. The default is **OFF**, which means the passwords are different.
 - **Use SSL:** Select whether the outgoing mail server uses Secure Socket Layer authentication. The default is **OFF**.
- **Policy**
 - **Note:** For iOS settings, these options apply only to iOS 5.0 and later. There are no restrictions for macOS.
 - **Authorize email move between accounts:** Select whether to allow users to move email out of this account into another account and to forward and reply from a different account. The default is **OFF**.
 - **Sending email only from mail app:** Select whether to restrict users to the iOS mail app for sending email.
 - **Disable mail recents syncing:** Select whether to prevent users from syncing recent addresses. The default is **OFF**. This option applies only to iOS 6.0 and later.
 - **Allow Mail Drop:** Select whether to allow use of Apple Mail Drop for devices running iOS 9.2 and later. The default is **OFF**.
 - **Enable S/MIME:** Select whether this account supports S/MIME authentication and encryption. The default is **OFF**. When set to ON, the following two fields appear.
 - **Signing identity credential:** Choose the signing credential to use.
 - **Encryption identity credential:** Choose the encryption credential to use.
- **Policy Settings**
 - Next to **Remove policy**, click either **Select date** or **Duration until removal (in hours)**.
 - If you click **Select date**, click the calendar to select the specific date for removal.
 - In the **Allow user to remove policy** list, click **Always**, **Password required**, or **Never**.
 - If you click **Password required**, next to **Removal password**, type the password.
 - Next to **Profile scope**: Choose either **User** or **System**. The default is **User**. This option is available only on Mac OS X 10.7 and later.

8. Configure deployment rules and choose delivery groups. For more information, see [Add a device policy](#).

Managed domains device policy

Jun 19, 2017

You can define managed domains that apply to email and the Safari browser. Managed domains help you protect corporate data by controlling which apps can open documents downloaded from domains using Safari.

For iOS 8 and later supervised devices, you specify URLs or subdomains to control how users can open documents, attachments, and downloads from the browser. For iOS 9.3 and later supervised devices, you can specify the URLs from which users can save passwords in Safari.

For the steps on setting an iOS device to supervised mode, see [To place an iOS device in Supervised mode by using the Apple Configurator](#).

When a user sends email to a recipient whose domain is not on the managed email domains list, the message is flagged on the user's device to warn them that they are sending a message to someone outside your corporate domain.

For items such as documents, attachments, or downloads: When a user opens an item by using Safari from a web domain that is on the managed web domains list, the appropriate corporate app opens the item. If the item is not from a web domain on the managed web domains list, the user cannot open the item with a corporate app. They must use a personal, unmanaged app.

For supervised devices, even if you do not specify Safari password autofill domains: If the device is configured as ephemeral multi-user, users can't save passwords. However, if the device isn't configured as ephemeral multi-user, users can save all passwords.

1. In the XenMobile console, click **Configure > Device Policies**. The **Device Policies** page appears.
2. Click **Add**. The **Add New Policy** dialog box appears.
3. Expand **More** and then, under **Security**, click **Managed domains**. The **Managed Domains Policy** information page appears.
4. In the **Policy Information** pane, type the following information:
 - **Policy Name:** Type a descriptive name for the policy.
 - **Description:** Type an optional description of the policy.
5. Click **Next**. The **iOS Platform** page appears.

The screenshot shows the XenMobile configuration interface for the 'Managed Domains Policy'. The top navigation bar includes 'XenMobile', 'Analyze', 'Manage', and 'Configure'. The user is logged in as 'administrator'. The main navigation tabs are 'Device Policies', 'Apps', 'Actions', 'ShareFile', 'Enrollment Profiles', and 'Delivery Groups'. The left sidebar shows 'Managed Domains Policy' with sub-items: '1 Policy Info', '2 Platforms', '3 Assignment', and 'iOS' (which is selected). The main content area is titled 'Managed Domains Policy' and includes a description: 'This policy lets you define managed domains that apply to the Safari browser. The policy is supported only on iOS 8 and later devices.' Below this are three sections for adding domains: 'Unmarked Email Domains' with a 'Managed Email Domain' field and 'Add' button; 'Managed Safari Web Domains' with a 'Managed Web Domain' field and 'Add' button; and 'Safari Password AutoFill Domains' with a 'Safari Password AutoFill Domain' field and 'Add' button. The 'Policy Settings' section has 'Remove policy' options: 'Select date' (selected) and 'Duration until removal (in days)' with a date picker. There is also an 'Allow user to remove policy' dropdown set to 'Always'. At the bottom right are 'Back' and 'Next >' buttons.

6. Configure these settings:

- **Managed Domains**

- **Unmarked Email Domains:** For each email domain you want to include in the list, click **Add** and then do the following:
 - **Managed Email Domain:** Type the email domain.
 - Click **Save** to save the email domain or click **Cancel** to not save the email domain.
- **Managed Safari Web Domains:** For each web domain you want to include in the list, click **Add** and then do the following:
 - **Managed Web Domain:** Type the web domain.
 - Click **Save** to save the web domain or click **Cancel** to not save the web domain.
- **Safari Password AutoFill Domains:**

For each autofill domain you want to include in the list, click **Add** and then do the following:

 - **Safari Password AutoFill Domain:** Type the autofill domain.
 - Click **Save** to save the autofill domain or click **Cancel** to not save the autofill domain.

Note: To delete an existing domain, hover over the line containing the listing and then click the trash can icon on the right side. A confirmation dialog box appears. Click **Delete** to delete the listing or **Cancel** to keep the listing.

To edit an existing domain, hover over the line containing the listing and then click the pen icon on the right-hand side. Make any changes to the listing and then click **Save** to save the changed listing or **Cancel**.

- **Policy Settings**

- Under **Policy Settings**, next to **Remove policy**, click either **Select date** or **Duration until removal (in hours)**.
- If you click **Select date**, click the calendar to select the specific date for removal.
- In the **Allow user to remove policy** list, click **Always**, **Password required**, or **Never**.
- If you click **Password required**, next to **Removal password**, type the necessary password.

7. Configure deployment rules and choose delivery groups. For more information, see [Add a device policy](#).

MDM options device policy

Jun 19, 2017

You can create a device policy in XenMobile to manage Find My Phone/iPad Activation Lock on supervised iOS 7.0 and later phone devices. For the steps on setting an iOS device to supervised mode, see [To place an iOS device in Supervised mode by using the Apple Configurator](#).

Activation Lock is a feature of Find My iPhone/iPad that is designed to prevent reactivation of lost or stolen devices by requiring the user's Apple ID and password before anyone can turn off Find My iPhone, erase the device, or reactivate and use the device. In XenMobile, you can bypass the Apple ID and password requirement by enabling Activation Lock in the MDM Options device policy. When a user returns a device with Find My iPhone enabled, you can manage the device from the XenMobile console without their Apple credentials.

1. In the XenMobile console, click **Configure > Device Policies**. The **Device Policies** page appears.
2. Click **Add**. The **Add a New Policy** dialog box appears.
3. Expand **More** and then, under **End user**, click **MDM Options**. The **MDM Options Policy** information page appears.
4. In the **Policy Information** pane, type the following information:
 - **Policy Name:** Type a descriptive name for the policy.
 - **Description:** Type an optional description of the policy.
5. Click **Next**. The **iOS MDM Policy Platform** page appears.

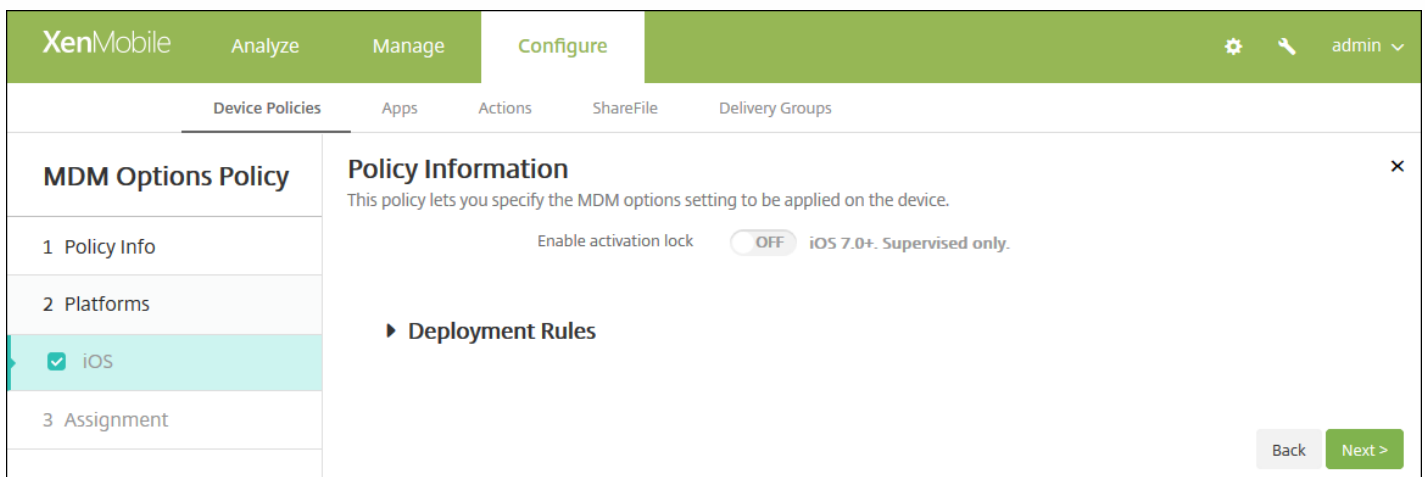

6. Configure this setting:
 - **Enable Activation Lock:** Select whether to enable Activation Lock on the devices to which you deploy this policy. The default is **OFF**.
7. Configure deployment rules and choose delivery groups. For more information, see [Add a device policy](#).

Microsoft Exchange ActiveSync device policy

Jun 19, 2017

You can use the Exchange ActiveSync device policy to configure an email client on user devices to let them access their corporate email hosted on Exchange. You can create policies for iOS, Mac OS X, Android HTC, Android TouchDown, Android for Work, Samsung SAFE, Samsung KNOX, Windows Phone, and Windows Tablet. Each platform requires a different set of values, which are described in detail in the following sections.

[iOS settings](#)

[Mac OS X settings](#)

[Android HTC settings](#)

[Android TouchDown settings](#)

[Android for Work settings](#)

[Samsung SAFE and Samsung KNOX settings](#)

[Windows Phone and Windows Desktop/Tablet settings](#)

To create this policy, you need the host name or IP address of the Exchange Server. For information about ActiveSync settings, see the Microsoft article [ActiveSync CSP](#).

1. In the XenMobile console, click **Configure > Device Policies**. The **Device Policies** page appears.
2. Click **Add**. The **Add a New Policy** dialog box appears:
3. Click **Exchange**. The **Exchange Policy** information page appears.
 - XenMobile Server configured in Enterprise (XME) or MDM mode
 - LDAP configured
 - If using local groups and local users:
 - One or more local groups.
 - Local users assigned to local groups.
 - Delivery groups are associated with local groups.
 - If using Active Directory:
 - Delivery groups are associated with Active Directory groups.

The screenshot shows the XenMobile configuration interface. At the top, there are tabs for 'Analyze', 'Manage', and 'Configure'. The 'Configure' tab is active. Below the tabs, there are sub-tabs for 'Device Policies', 'Apps', 'Actions', 'ShareFile', 'Enrollment Profiles', and 'Delivery Groups'. The 'Device Policies' sub-tab is selected. On the left, there is a sidebar for 'Exchange Policy' with three main sections: '1 Policy Info', '2 Platforms', and '3 Assignment'. Under '2 Platforms', several operating systems are listed with checked checkboxes: iOS, Mac OS X, Android HTC, Android TouchDown, Android for Work, Samsung SAFE, Samsung KNOX, Windows Phone, and Windows Desktop/Tablet. The '1 Policy Info' section is currently active, showing a 'Policy Information' dialog box. This dialog box contains a 'Policy Name*' text input field and a 'Description' text area. A note above these fields states: 'This policy configures Microsoft Exchange ActiveSync so users can run Exchange email on their devices. When you create this policy, you need the host name or IP address for the Exchange Server.'

4. In the **Policy Information** pane, type the following information:

- **Policy Name:** Type a descriptive name for the policy.
- **Description:** Type an optional description of the policy.

5. Under **Platforms**, select the platforms you want to add. If you are only configuring for one platform, clear the others.

When you finish configuring the settings for a platform, refer to Step 7 for how to set deployment rules.

Configure iOS settings

The screenshot shows the XenMobile configuration interface for an Exchange Policy. The top navigation bar includes 'XenMobile', 'Analyze', 'Manage', and 'Configure'. The 'Configure' tab is active, and the 'Exchange Policy' section is selected in the sidebar. The main configuration area contains the following fields and options:

- Exchange ActiveSync account name***: Text input field.
- Exchange ActiveSync host name***: Text input field.
- Use SSL**: Toggle switch set to **ON**.
- Domain**: Text input field.
- User**: Text input field.
- Email address**: Text input field.
- Password**: Text input field.
- Email sync interval**: Dropdown menu set to **3 days**.
- Identity credential (keystore or PKI credential)**: Dropdown menu set to **None**.
- Authorize email move between accounts**: Toggle switch set to **OFF**.
- Send email only from email app**: Toggle switch set to **OFF**.

Configure these settings:

- **Exchange ActiveSync account name:** Type the description of the email account that is displayed on user devices.
- **Exchange ActiveSync host name:** Type the address of the email server.
- **Use SSL:** Select whether to secure connections between user devices and the Exchange Server. The default is **ON**.
- **Domain:** Enter the domain in which the Exchange Server resides. You can use the system macro \$user.domainname in this field to automatically look up user domain names.
- **User:** Specify the user name for the Exchange user account. You can use the system macro \$user.username in this field to automatically look up user names.
- **Email address:** Specify the full email address. You can use the system macro \$user.mail in this field to automatically look up user email accounts.
- **Password:** Enter an optional password for the Exchange user account.
- **Email sync interval:** In the list, choose how often email is synced with the Exchange Server. The default is **3 days**.
- **Identity credential (keystore or PKI):** In the list, click an optional identity credential if you have configured an identity provider for XenMobile. This field is only required when Exchange requires a client certificate authentication. The default is **None**.
- **Authorize email move between accounts:** Select whether to allow users to move email out of this account into another account and to forward and reply from a different account. The default is **OFF**.
- **Send email only from email app:** Select whether to restrict users to the iOS mail app for sending email. The default is **OFF**.
- **Disable email recent syncing:** Select whether to prevent users from syncing recent addresses. The default is **OFF**. This option applies only to iOS 6.0 and later.
- **Enable S/MIME:** Select whether this account supports S/MIME authentication and encryption. The default is **OFF**. When set to **ON**, the following two fields appear:
 - **Signing identity credential.** The default is **None**.

- **Encryption identity credential.** The default is **None**.
- **Enable per message S/MIME switch:** Select whether to allow users to encrypt outgoing email on a per-message basis. The default is **OFF**.

Configure Mac OS X settings

- XenMobile Server configured in Enterprise (XME) or MDM mode
- LDAP configured
- If using local groups and local users:
 - One or more local groups.
 - Local users assigned to local groups.
 - Delivery groups are associated with local groups.
- If using Active Directory:
 - Delivery groups are associated with Active Directory groups.

The screenshot displays the 'Exchange Policy' configuration page in the XenMobile console. The left sidebar shows a list of platforms with checkboxes, where 'Mac OS X' is selected. The main content area is titled 'Exchange Policy' and includes a descriptive paragraph: 'This policy configures Microsoft Exchange ActiveSync so users can run Exchange email on their devices. When you create this policy, you need the host name or IP address for the Exchange Server.' Below this, there are several input fields: 'Exchange ActiveSync account name*', 'User*', 'Email address*', and 'Password'. There are also fields for 'Internal Exchange host', 'Internal server port', and 'Internal server path'. A toggle switch for 'Use SSL for internal Exchange host' is currently set to 'ON'. At the bottom, there are fields for 'External Exchange host', 'External server port', and 'External server path'.

Configure these settings:

- **Exchange ActiveSync account name:** Type the description of the email account that is displayed on user devices.
- **User:** Specify the user name for the Exchange user account. You can use the system macro \$user.username in this field to automatically look up user names.
- **Email address:** Specify the full email address. You can use the system macro \$user.mail in this field to automatically look up user email accounts.
- **Password:** Enter an optional password for the Exchange user account.

- **Internal Exchange host:** If you want your internal and external Exchange host names to be different, type an optional internal Exchange host name.
- **Internal server port:** If you want your internal and external Exchange server ports to be different, type an optional internal Exchange server port number.
- **Internal server path:** If you want your internal and external Exchange server paths to be different, type an optional internal Exchange server path.
- **Use SSL for internal Exchange host:** Select whether to secure connections between user devices and the internal Exchange host. The default is **ON**.
- **External Exchange host:** If you want your internal and external Exchange host names to be different, type an optional external Exchange host name.
- **External server port:** If you want your internal and external Exchange server ports to be different, type an optional external Exchange server port number.
- **External server path:** If you want your internal and external Exchange server paths to be different, type an optional external Exchange server path.
- **Use SSL for external Exchange host:** Select whether to secure connections between user devices and the internal Exchange host. The default is **ON**.
- **Allow Mail Drop:** Select whether to allow users to share files wirelessly between two Macs, without having to connect to an existing network. The default is **OFF**.

Configure Android HTC settings

The screenshot shows the XenMobile configuration interface for an Exchange Policy. The interface is divided into a sidebar and a main configuration area.

Sidebar:

- Exchange Policy
- 1 Policy Info
- 2 Platforms
 - iOS
 - Mac OS X
 - Android HTC**
 - Android TouchDown
 - Android for Work
 - Samsung SAFE
 - Samsung KNOX
 - Windows Phone
 - Windows Desktop/Tablet
- 3 Assignment

Main Configuration Area:

Exchange Policy
This policy configures Microsoft Exchange ActiveSync so users can run Exchange email on their devices. When you create this policy, you need the host name or IP address for the Exchange Server.

Configuration display name*

Server address*

User ID*

Password

Domain

Email address*

Use SSL ON

Deployment Rules

Configure these settings:

- **Configuration display name:** Type the name for this policy that appears on user devices.
- **Server address:** Type the Exchange Server host name or IP address.
- **User ID:** Specify the user name for the Exchange user account. You can use the system macro `$user.username` in this

field to automatically look up user names.

- **Password:** Enter an optional password for the Exchange user account.
- **Domain:** Enter the domain in which the Exchange Server resides. You can use the system macro \$user.domainname in this field to automatically look up user domain names.
- **Email address:** Specify the full email address. You can use the system macro \$user.mail in this field to automatically look up user email accounts.
- **Use SSL:** Select whether to secure connections between user devices and the Exchange Server. The default is **ON**.

Configure Android TouchDown settings

Exchange Policy

This policy configures Microsoft Exchange ActiveSync so users can run Exchange email on their devices. When you create this policy, you need the host name or IP address for the Exchange Server.

Server name or IP address*

Domain

User ID*

Password

Email address

Identity credential (keystore or PKI)

Policies and Apps

App Setting

Name	Value	Add
------	-------	-----

Policy

Name	Value	Add
------	-------	-----

► **Deployment Rules**

Configure these settings:

- **Server name or IP address:** Type the Exchange Server host name or IP address.
- **Domain:** Type the domain in which the Exchange Server resides. You can use the system macro \$user.domainname in this field to automatically look up user domain names.
- **User ID:** Specify the user name for the Exchange user account. You can use the system macro \$user.username in this field to automatically look up user names.
- **Password:** Type an optional password for the Exchange user account.
- **Email address:** Specify the full email address. You can use the system macro \$user.mail in this field to automatically look up user email accounts.
- **Identity credential (keystore or PKI):** In the list, click an optional identity credential if you have configured an identity provider for XenMobile. This field is only required when Exchange requires a client certificate authentication. The default is **None**.
- **App Setting:** Optionally, add TouchDown app settings for this policy.
- **Policy:** Optionally, add TouchDown policies for this policy.

Configure Android for Work

The screenshot shows the XenMobile configuration interface for an Exchange Policy. The navigation menu on the left includes 'Exchange Policy', '1 Policy Info', '2 Platforms', and '3 Assignment'. Under '2 Platforms', several operating systems are listed with checkboxes: iOS, Mac OS X, Android HTC, Android TouchDown, Android for Work (highlighted), Samsung SAFE, Samsung KNOX, Windows Phone, and Windows Desktop/Tablet. The main configuration area for the Exchange Policy includes a description: 'This policy configures Microsoft Exchange ActiveSync so users can run Exchange email on their devices. When you create this policy, you need the host name or IP address for the Exchange Server.' Below this are several input fields: 'Server name or IP address*', 'Domain', 'User ID*', 'Password', 'Email address', and 'Identity credential (keystore or PKI)' with a dropdown menu set to 'None'. A 'Deployment Rules' section is also visible.

Configure these settings:

- **Server name or IP address:** Type the Exchange Server host name or IP address.
- **Domain:** Type the domain in which the Exchange Server resides. You can use the system macro \$user.domainname in this field to automatically look up user domain names.
- **User ID:** Specify the user name for the Exchange user account. You can use the system macro \$user.username in this field to automatically look up user names.
- **Password:** Type an optional password for the Exchange user account.
- **Email address:** Specify the full email address. You can use the system macro \$user.mail in this field to automatically look up user email accounts.
- **Identity credential (keystore or PKI):** In the list, click an optional identity credential if you have configured an identity provider for XenMobile. This field is only required when Exchange requires a client certificate authentication. The default is **None**.

Configure Samsung SAFE and Samsung KNOX settings

The screenshot shows the XenMobile 'Configure' page for an 'Exchange Policy'. The top navigation bar includes 'XenMobile', 'Analyze', 'Manage', and 'Configure'. The user is logged in as 'administrator'. The main content area is titled 'Exchange Policy' and includes a description: 'This policy configures Microsoft Exchange ActiveSync so users can run Exchange email on their devices. When you create this policy, you need the host name or IP address for the Exchange Server.'

The configuration area contains the following fields and options:

- Server name or IP address***: Text input field.
- Domain**: Text input field.
- User ID***: Text input field.
- Password**: Text input field.
- Email address***: Text input field.
- Identity credential (keystore or PKI)**: Dropdown menu with 'None' selected.
- Use SSL connection**: Toggle switch (ON).
- Sync contacts**: Toggle switch (ON).
- Sync calendar**: Toggle switch (ON).
- Default account**: Toggle switch (ON).

The sidebar on the left shows a table of platform checkboxes:

Exchange Policy	
1	Policy Info
2	Platforms
<input checked="" type="checkbox"/>	iOS
<input checked="" type="checkbox"/>	Mac OS X
<input checked="" type="checkbox"/>	Android HTC
<input checked="" type="checkbox"/>	Android TouchDown
<input checked="" type="checkbox"/>	Android for Work
<input checked="" type="checkbox"/>	Samsung SAFE
<input checked="" type="checkbox"/>	Samsung KNOX
<input checked="" type="checkbox"/>	Windows Phone
<input checked="" type="checkbox"/>	Windows Desktop/Tablet
3	Assignment

Configure these settings:

- **Server name or IP address:** Type the Exchange Server host name or IP address.
- **Domain:** Type the domain in which the Exchange Server resides. You can use the system macro \$user.domainname in this field to automatically look up user domain names.
- **User ID:** Specify the user name for the Exchange user account. You can use the system macro \$user.username in this field to automatically look up user names.
- **Password:** Type an optional password for the Exchange user account.
- **Email address:** Specify the full email address. You can use the system macro \$user.mail in this field to automatically look up user email accounts.
- **Identity credential (keystore or PKI):** In the list, click an optional identity credential if you have configured an identity provider for XenMobile. This field is only required when Exchange requires a client certificate authentication.
- **Use SSL connection:** Select whether to secure connections between user devices and the Exchange Server. The default is **ON**.
- **Sync contacts:** Select whether to enable synchronization for user contacts between devices and the Exchange Server. The default is **ON**.
- **Sync calendar:** Select whether to enable synchronization for user calendars between devices and the Exchange Server. The default is **ON**.
- **Default account:** Select whether to make user Exchange accounts the default for sending email from their devices. The default is **ON**.

Configure Windows Phone and Windows Desktop/Tablet settings

Exchange Policy

This policy configures Microsoft Exchange ActiveSync so users can run Exchange email on their devices. When you create this policy, you need the host name or IP address for the Exchange Server.

Account name or display name* exchange

Server name or IP address* 170.10.10.10

Domain \$user.domainname

User ID or user name* \$user.samaccountname

Email address* \$user.mail

Use SSL connection ON

Sync items

Past days to sync Last 3 days

Sync scheduling

Frequency When item arrives

Logging level Disabled

► **Deployment Rules**

Configure these settings:

Note: This policy does not allow you to set the user password. Users must set that parameter from their devices after you push the policy.

- **Account name or display name:** Type the Exchange ActiveSync account name.
- **Server name or IP address:** Type the Exchange Server host name or IP address.
- **Domain:** Enter the domain in which the Exchange Server resides. You can use the system macro \$user.domainname in this field to automatically look up user domain names.
- **User ID or user name:** Specify the user name for the Exchange user account. You can use the system macro \$user.username in this field to automatically look up user names.
- **Email address:** Specify the full email address. You can use the system macro \$user.mail in this field to automatically look up user email accounts.
- **Use SSL connection:** Select whether to secure connections between user devices and the Exchange Server. The default is **OFF**.
- **Past days to sync:** In the list, click how many days into the past to sync all content on the device with the Exchange Server. The default is **All content**.
- **Frequency:** In the list, click the schedule to use when syncing data that is sent to the device from the Exchange Server. The default is **When it arrives**.
- **Logging level:** In the list, click **Disabled**, **Basic**, or **Advanced** to specify the level of detail when logging Exchange activity. The **default is Disabled**.

7. Configure deployment rules and choose delivery groups. For more information, see [Add a device policy](#).

Organization information device policy

Jun 19, 2017

You can add a device policy in XenMobile to specify your organization's information for alert messages that are pushed from XenMobile to iOS devices. The policy is available for iOS 7 and later devices.

1. In the XenMobile console, click **Configure** > **Device Policies**. The **Device Policies** page appears.
2. Click **Add**. The **Add a New Policy** dialog box appears.
3. Click **More** and then, under **End user**, click **Organization info**. The **Organization Info Policy** page appears.
4. In the **Policy Information** pane, enter the following information:
 - **Policy Name:** Type a descriptive name for the policy.
 - **Description:** If desired, type a description of the policy.
5. Click **Next**. The **iOS Platform Information** page appears.

The screenshot shows the XenMobile console interface. The top navigation bar includes 'XenMobile', 'Analyze', 'Manage', and 'Configure'. Below this is a sub-navigation bar with 'Device Policies', 'Apps', 'Actions', 'ShareFile', and 'Delivery Groups'. The main content area is titled 'Organization Info Policy' and is divided into three sections: '1 Policy Info', '2 Platforms', and '3 Assignment'. The '2 Platforms' section is expanded, showing 'iOS' selected with a checkmark. The 'Policy Information' pane is open, displaying a description and five input fields: 'Name', 'Address', 'Phone', 'Email', and 'Magic'. Each field has a question mark icon to its right. To the right of each field is the text 'iOS 7.0+'. At the bottom of the main area is a section titled 'Deployment Rules'. At the bottom right of the page are 'Back' and 'Next >' buttons.

Configure these settings:

- **Name:** Type the name of the organization running XenMobile.
- **Address:** Type the organization's address.

- **Phone:** Type the organization's support phone number.
- **Email:** Type the support email address.
- **Magic:** Type a word or phrase that describes the services managed by the organization.

7. Configure deployment rules and choose delivery groups. For more information, see [Add a device policy](#).

Passcode device policy

Jun 19, 2017

You create a passcode policy in XenMobile based on your organization's standards. You can require passcodes on users' devices and can set various formatting and passcode rules. You can create policies for iOS, Mac OS X, Android, Samsung KNOX, Android for Work, Windows Phone, and Windows desktop/tablet. Each platform requires a different set of values, which are described in this article.

[iOS settings](#)

[Mac OS X settings](#)

[Android settings](#)

[Samsung KNOX settings](#)

[Android for Work settings](#)

[Windows Phone settings](#)

[Windows Desktop/Tablet settings](#)

1. In the XenMobile console, click **Configure** > **Device Policies**. The **Device Policies** page appears.
2. Click **Add**. The Add New Policy page appears.
3. Click **Passcode**. The Passcode Policy information page appears.

XenMobile Analyze Manage **Configure** admin

Device Policies Apps Actions ShareFile Delivery Groups

Passcode Policy

- 1 Policy Info
- 2 Platforms
 - iOS
 - Mac OS X
 - Android
 - Samsung KNOX
 - Android for Work
 - Windows Phone
 - Windows Desktop/Tablet
- 3 Assignment

Policy Information

This policy creates a passcode policy based on the standards of your organization. You can require a code on the device and can set formatting rules and other passcode rules, such as the grace period before device lock.

Policy Name*

Description

Next >

4. In the **Policy Information** pane, enter the following information:

- **Policy Name:** Type a descriptive name for the policy.
- **Description:** Optionally, type a description of the policy.

5. Click **Next**. The **Platforms** page appears.

6. Under **Platforms**, select the platforms you want to add. If you are only configuring for one platform, clear the others.

When you finish configuring the settings for a platform, refer to Step 7 for how to set that platform's deployment rules.

The screenshot shows the XenMobile configuration interface for a Passcode Policy. The top navigation bar includes 'XenMobile', 'Analyze', 'Manage', and 'Configure'. Below this, there are tabs for 'Device Policies', 'Apps', 'Actions', 'ShareFile', and 'Delivery Groups'. The main content area is titled 'Passcode Policy' and is divided into two sections: 'Policy Information' and 'Passcode requirements'. The 'Policy Information' section includes a description and several settings: 'Passcode required' (ON), 'Minimum length' (6), 'Allow simple passcodes' (ON), 'Required characters' (OFF), 'Minimum number of symbols' (0), 'Device lock grace period (minutes of inactivity)' (None), 'Lock device after (minutes of inactivity)' (None), 'Passcode expiration in days (1-730)' (0), 'Previous passcodes saved (0-50)' (0), and 'Maximum failed sign-on attempts' (Not defined). The 'Passcode requirements' section is currently empty. At the bottom right, there are 'Back' and 'Next >' buttons.

Configure the following settings:

- **Passcode required:** Select this option to require a passcode and to display the configuration options for an iOS passcode device policy. The page expands to let you configure settings for passcode requirements, passcode security, and policy settings.
- **Passcode requirements**
 - **Minimum length:** In the list, click the minimum passcode length. The default is **6**.
 - **Allow simple passcodes:** Select whether to allow simple passcodes. Simple passcodes are a repeated or sequential set of characters. The default is **ON**.
 - **Required characters:** Select whether to require passcodes to have at least one letter. The default is **OFF**.
 - **Minimum number of symbols:** In the list, click the number of symbols the passcode must contain. The default is **0**.
- **Passcode security**
 - **Device lock grace period (minutes of inactivity):** In the list, click the length of time before users must enter a passcode to unlock a locked device. The default is **None**.
 - **Lock device after (minutes of inactivity):** In the list, click the length of time a device can be inactive before it is locked. The default is **None**.
 - **Passcode expiration in days (1-730):** Type the number of days after which the passcode expires. Valid values are 1-730. The default is **0**, which means the passcode never expires.
 - **Previous passwords saved (0-50):** Type the number of used passwords to save. Users are unable to use any

password found in this list. Valid values are 0-50. The default is 0, which means users can reuse passwords.

- **Maximum failed sign-on attempts:** In the list, click the number of times a user can fail to sign in successfully after which the device is fully wiped. The default is **Not defined**.
- **Policy Settings**
 - Next to **Remove policy**, click either **Select date** or **Duration until removal (in hours)**.
 - If you click **Select date**, click the calendar to select the specific date for removal.
 - In the **Allow user to remove policy** list, click **Always**, **Password required**, or **Never**.
 - If you click **Password required**, next to **Removal password**, type the necessary password.

Passcode Policy

This policy creates a passcode policy based on the standards of your organization. You can require a code on the device and can set formatting rules and other passcode rules, such as the grace period before device lock.

Passcode required

Passcode requirements

Minimum length 6

Allow simple passcodes

Required characters

Minimum number of symbols 0

Passcode security

Device lock grace period (minutes of inactivity) None

Lock device after (minutes of inactivity) None

Passcode expiration in days (1-730) 0

Previous passwords saved (0-50) 0

Maximum failed sign-on attempts Not defined

Back Next >

Configure these settings:

- **Passcode required:** Select this option to require a passcode and to display the configuration options for an iOS passcode device policy. The page expands to let you configure settings for passcode requirements, passcode security, and policy settings.
- If you do not enable **Passcode required**, next to **Delay after failed sign-on attempts, in minutes**, type the number of minutes to delay before allowing users to reenter their passcodes.
- If you enable **Passcode required**, configure the following settings:
- **Passcode requirements**
 - **Minimum length:** In the list, click the minimum passcode length. The default is **6**.
 - **Allow simple passcodes:** Select whether to allow simple passcodes. Simple passcodes are a repeated or sequential set of characters. The default is **ON**.
 - **Required characters:** Select whether to require passcodes to have at least one letter. The default is **OFF**.
 - **Minimum number of symbols:** In the list, click the number of symbols the passcode must contain. The default is **0**.
- **Passcode security**
 - **Device lock grace period (minutes of inactivity):** In the list, click the length of time before users must enter a

passcode to unlock a locked device. The default is **None**.

- **Lock device after (minutes of inactivity):** In the list, click the length of time a device can be inactive before it is locked. The default is **None**.
- **Passcode expiration in days (1-730):** Type the number of days after which the passcode expires. Valid values are 1-730. The default is **0**, which means the passcode never expires.
- **Previous passwords saved (0-50):** Type the number of used passwords to save. Users are unable to use any password found in this list. Valid values are 0-50. The default is **0**, which means users can reuse passwords.
- **Maximum failed sign-on attempts:** In the list, click the number of times a user can fail to sign in successfully after which the device is locked. The default is **Not defined**.
- **Delay after failed sign-on attempts, in minutes:** Type the number of minutes to delay before allowing a user to reenter a passcode.
- **Policy Settings**
 - Next to **Remove policy**, click either **Select date** or **Duration until removal (in hours)**.
 - If you click **Select date**, click the calendar to select the specific date for removal.
 - In the **Allow user to remove policy** list, click **Always**, **Password required**, or **Never**.
 - If you click **Password required**, next to **Removal password**, type the necessary password.
 - Next to **Profile scope**, click either **User** or **System**. The default is **User**. This option is available only on OS X 10.7 and later.

The screenshot shows the XenMobile Configure interface. The top navigation bar includes 'XenMobile', 'Analyze', 'Manage', and 'Configure'. Below this, there are tabs for 'Device Policies', 'Apps', 'Actions', 'ShareFile', and 'Delivery Groups'. The main content area is titled 'Passcode Policy' and includes a sidebar with navigation options: '1 Policy Info', '2 Platforms', and '3 Assignment'. The 'Platforms' section is expanded, showing checkboxes for 'iOS', 'Mac OS X', 'Android', 'Samsung KNOX', 'Android for Work', 'Windows Phone', and 'Windows Desktop/Tablet'. The 'Android' option is selected. The main content area shows the following settings:

- Passcode Required:** ON (toggle)
- Passcode requirements:**
 - Minimum length:** 6
 - Biometric recognition:** OFF (toggle)
 - Required characters:** No restriction
 - Advanced rules:** OFF (toggle) A 3.0+
- Passcode security:**
 - Lock device after (minutes of inactivity):** None
 - Passcode expiration in days (1-730):** 0
 - Previous passwords saved (0-50):** 0
 - Maximum failed sign-on attempts:** Not defined
- Encryption:** (empty field)

At the bottom right, there are 'Back' and 'Next >' buttons.

Configure these settings:

Note: The default setting for Android is **OFF**.

- **Passcode required:** Select this option to require a passcode and to display the configuration options for an Android passcode device policy. The page expands to let you configure settings for passcode requirements, passcode security,

encryption, and Samsung SAFE.

- **Passcode requirements**
 - **Minimum length:** In the list, click the minimum passcode length. The default is 6.
 - **Biometric recognition:** Select whether to enable biometric recognition. If you enable this option, the Required characters field is hidden. The default is **OFF**.
 - **Required characters:** In the list, click No Restriction, Both numbers and letters, Numbers only, or Letters only to configure how passcodes are composed. The default is No restriction.
 - **Advanced rules:** Select whether to apply advanced passcode rules. This option is available for Android 3.0 and later. The default is **OFF**.
 - When you enable **Advanced rules**, from each of the following lists, click the minimum number of each character type that a passcode must contain:
 - **Symbols:** The minimum number of symbols.
 - **Letters:** The minimum number of letters.
 - **Lowercase letters:** The minimum number of lowercase letters.
 - **Uppercase letters:** The minimum number of uppercase letters.
 - **Numbers or symbols:** The minimum number of numbers or symbols.
 - **Numbers:** The minimum number of numbers.
- **Passcode security**
 - **Lock device after (minutes of inactivity):** In the list, click the length of time a device can be inactive before it is locked. The default is **None**
 - **Passcode expiration in days (1-730):** Type the number of days after which the passcode expires. Valid values are 1-730. The default is **0**, which means the passcode never expires.
 - **Previous passwords saved (0-50):** Type the number of used passwords to save. Users are unable to use any password found in this list. Valid values are 0-50. The default is **0**, which means users can reuse passwords.
 - **Maximum failed sign-on attempts:** In the list, click the number of times a user can fail to sign in successfully after which the device is wiped. The default is **Not defined**.
- **Encryption**
 - **Enable encryption:** Select whether to enable encryption. This option is available for Android 3.0 and later. The option is available regardless of the **Passcode required** setting.

Note: To encrypt their devices, users must start with a charged battery and keep the device plugged in for the hour or more that encryption takes. If they interrupt the encryption process, they may lose some or all of the data on their devices. After a device is encrypted, the process cannot be reversed except by doing a factory reset, which erases all the data on the device.

- **Samsung SAFE**
 - **Use same passcode across all users:** Select whether to use the same passcode for all users. The default is **OFF**. This setting applies only to Samsung SAFE devices and is available regardless of the **Passcode required** setting.
 - When you enable **Use same passcode across all users**, type the passcode to be used by all users in the **Passcode** field.
 - When you enable **Passcode required**, configure the following Samsung SAFE settings:
 - **Changed characters:** Type the number of characters users must change from their previous passcode. The default is **0**.
 - **Number of times a character can occur:** Type the maximum number of times a character can occur in a passcode. The default is **0**.
 - **Alphabetic sequence length:** Type the maximum length of an alphabetic sequence in a passcode. The default is **0**.

- **Numeric sequence length:** Type the maximum length of a numeric sequence in a passcode. The default is 0.
- **Allow users to make password visible:** Select whether users can make their passcodes visible. The default is ON.
- **Forbidden strings:** You create forbidden strings to prevent users from using insecure strings that are easy to guess like "password", "pwd", "welcome", "123456", "111111", and so on. For each string you want to deny, click **Add** and then do the following:
 - **Forbidden strings:** Type the string users may not use.
 - Click **Save** to add the string or click **Cancel** to cancel adding the string.

Note: To delete an existing string, hover over the line containing the listing and click the trash can icon on the right-hand side. A confirmation dialog box appears. Click **Delete** to delete the listing or **Cancel** to keep the listing.

To edit an existing string, hover over the line containing the listing and click the pen icon on the right-hand side. Make any changes to the listing and then click **Save** to save the changed listing or **Cancel** to leave the listing unchanged.

The screenshot shows the 'Configure' page for a 'Passcode Policy' in XenMobile. The left sidebar has a navigation menu with sections: '1 Policy Info', '2 Platforms', and '3 Assignment'. Under '2 Platforms', several operating systems are listed with checkboxes: iOS, Mac OS X, Android, Samsung KNOX (highlighted), Android for Work, Windows Phone, and Windows Desktop/Tablet. The main content area is titled 'Passcode Policy' and includes a description: 'This policy creates a passcode policy based on the standards of your organization. You can require a code on the device and can set formatting rules and other passcode rules, such as the grace period before device lock.' Below this, there are several configuration sections:

- Passcode requirements:** 'Minimum length' is set to 6 in a dropdown menu. 'Allow users to make password visible' is a toggle switch set to 'OFF'.
- Forbidden Strings:** A table with one row labeled 'Forbidden strings' and an 'Add' button.
- Minimum number of:** Four input fields: 'Changed characters*' (0), 'Symbols*' (0).
- Maximum number of:** Three input fields: 'Number of times a character can occur*' (0), 'Alphabetic sequence length*' (0), 'Numeric sequence length*' (0).
- Passcode security:** A section with a horizontal line below it.

 At the bottom right, there are 'Back' and 'Next >' buttons.

Configure these settings:

- **Passcode requirements**
 - **Minimum length:** In the list, click the minimum passcode length. The default is 6.
 - **Allow users to make password visible:** Select whether to let users make the password visible.
 - **Forbidden strings:** You create forbidden strings to prevent users from using insecure strings that are easy to guess like "password", "pwd", "welcome", "123456", "111111", and so on. For each string you want to deny, click **Add** and then do the following:
 - **Forbidden strings:** Type the string users may not use.

- Click **Save** to add the string or click **Cancel** to cancel adding the string.

Note: To delete an existing string, hover over the line containing the listing and click the trash can icon on the right-hand side. A confirmation dialog box appears. Click **Delete** to delete the listing or **Cancel** to keep the listing.

To edit an existing string, hover over the line containing the listing and click the pen icon on the right-hand side. Make any changes to the listing and then click **Save** to save the changed listing or **Cancel** to leave the listing unchanged.

- **Minimum number of**
 - **Changed characters:** Type the number of characters users must change from their previous passcode. The default is 0.
 - **Symbols:** Type the minimum number of required symbols in a passcode. The default is 0.
- **Maximum number of**
 - **Number of times a character can occur:** Type the maximum number of times a character can occur in a passcode. The default is 0.
 - **Alphabetic sequence length:** Type the maximum length of an alphabetic sequence in a passcode. The default is 0.
 - **Numeric sequence length:** Type the maximum length of a numeric sequence in a passcode. The default is 0.
- **Passcode security**
 - **Lock device after (minutes of inactivity):** In the list, click the number of seconds a device can be inactive before it is locked. The default is **None**.
 - **Passcode expiration in days (1-730):** Type the number of days after which the passcode expires. Valid values are 1-730. The default is 0, which means the passcode never expires.
 - **Previous passwords saved (0-50):** Type the number of used passwords to save. Users are unable to use any password found in this list. Valid values are 0-50. The default is 0, which means users can reuse passwords.
 - **If the number of failed sign on attempts is exceeded, the device is locked:** In the list, click the number of times a user can fail to sign on successfully after which the device is locked. The default is **Not defined**.
 - **If the number of failed sign on attempts is exceeded, the device is wiped:** In the list, click the number of times a user can fail to sign on successfully, after which the KNOX container (along with the KNOX data) is wiped from the device. Users need to reinitialize the KNOX container after the wiping occurs. The default is **Not defined**.

Passcode Policy

Policy Information
This policy creates a passcode policy based on the standards of your organization. You can require a code on the device and can set formatting rules and other passcode rules, such as the grace period before device lock.

Passcode Required

Passcode requirements

- Minimum length:** 6
- Biometric recognition:** OFF
- Required characters:** No restriction
- Advanced rules:** OFF A 3.0+

Passcode security

- Lock device after (minutes of inactivity):** None
- Passcode expiration in days (1-730):** 0
- Previous passwords saved (0-50):** 0
- Maximum failed sign-on attempts:** Not defined

Configure these settings:

- **Passcode required:** Select this option to require a passcode and to display the configuration options for an Android for Work passcode device policy. The page expands to let you configure settings for passcode requirements and passcode security.
- **Passcode requirements**
 - **Minimum length:** In the list, click the minimum passcode length. The default is 6.
 - **Biometric recognition:** Select whether to enable biometric recognition. If you enable this option, the **Required characters** field is hidden. The default is **OFF**. Note that this feature is not currently supported.
 - **Required characters:** In the list, click **No Restriction**, **Both numbers and letters**, **Numbers only**, or **Letters only** to configure how passcodes are composed. The default is **No restriction**.
 - **Advanced rules:** Select whether to apply advanced passcode rules. This option is not available for Android devices earlier than Android 5.0. The default is **OFF**.
 - When you enable **Advanced rules**, from each of the following lists, click the minimum number of each character type that a passcode must contain:
 - **Symbols:** The minimum number of symbols.
 - **Letters:** The minimum number of letters.
 - **Lowercase letters:** The minimum number of lowercase letters.
 - **Uppercase letters:** The minimum number of uppercase letters.
 - **Numbers or symbols:** The minimum number of numbers or symbols.
 - **Numbers:** The minimum number of numbers.
- **Passcode security**
 - **Lock device after (minutes of inactivity):** In the list, click the number of minutes a device can be inactive before it is locked. The default is **None**
 - **Passcode expiration in days (1-730):** Type the number of days after which the passcode expires. Valid values are 1-730. The default is 0, which means the passcode never expires.
 - **Previous passwords saved (0-50):** Type the number of used passwords to save. Users are unable to use any

password found in this list. Valid values are 0-50. The default is 0, which means users can reuse passwords.

- **Maximum failed sign-on attempts:** In the list, click the number of times a user can fail to sign on successfully, after which the KNOX container (along with the KNOX data) is wiped from the device. Users need to reinitialize the KNOX container after the wiping occurs. The default is **Not defined**.

Configure these settings:

- **Passcode required:** Select this option to not require a passcode for Windows Phone devices. The default setting is ON, which requires a passcode. The page collapses and the following options disappear when you disable this setting.
- **Allow simple passcodes:** Select whether to allow simple passcodes. Simple passcodes are a repeated or sequential set of characters. The default is OFF.
- **Passcode requirements**
 - **Minimum length:** In the list, click the minimum passcode length. The default is 6.
 - **Characters required:** In the list, click **Numeric or alphanumeric**, **Letters only**, or **Numbers only** to configure how passcodes are composed. The default is **Letters only**.
 - **Minimum number of symbols:** In the list, click the number of symbols the passcode must contain. The default is 1.
- **Passcode security**
 - **Lock device after (minutes of inactivity):** Type the number of minutes a device can be inactive before it is locked. The default is 0.
 - **Passcode expiration in 0-730 days:** Type the number of days after which the passcode expires. Valid values are 0-730. The default is 0, which means the passcode never expires.
 - **Previous passwords saved (0-50):** Type the number of used passwords to save. Users are unable to use any password found in this list. Valid values are 0-50. The default is 0, which means users can reuse passwords.
 - **Maximum failed sign-on attempts before wipe (0-999):** Type the number of times a user can fail to sign on successfully after which corporate data is wiped from the device. The default is 0.

Configure these settings:

- **Disallow convenience logon:** Select whether to allow users to access their devices with picture passwords or biometric logons. The default is **OFF**.
- **Minimum passcode length:** In the list, click the minimum passcode length. The default is **6**.
- **Maximum passcode attempts before wipe:** In the list, click the number of times a user can fail to sign in successfully after which corporate data is wiped from the device. The default is **4**.
- **Passcode expiration in days (0-730):** Type the number of days after which the passcode expires. Valid values are 0-730. The default is **0**, which means the passcode never expires.
- **Passcode history: (1-24):** Type the number of used passcodes to save. Users are unable to use any passcode found in this list. Valid values are 1-24. You must enter a number between 1 and 24 in this field. The default is **0**.
- **Maximum inactivity before device lock in minutes (1-999):** Type the length of time in minutes that a device can be inactive before it is locked. Valid values are 1-999. You must enter a number between 1 and 999 in this field. The default is **0**.

7. Configure deployment rules and choose delivery groups. For more information, see [Add a device policy](#).

Personal hotspot device policy

Jun 19, 2017

You can allow users to connect to the Internet when they are not in range of a WiFi network by using the cellular data connection through their iOS devices' personal hotspot functionality. Available on iOS 7.0 and later.

1. In the XenMobile console, click **Configure** > **Device Policies**. The **Device Policies** page appears.
2. Click **Add**. The **Add a New Policy** page appears.
3. Expand **More**, and then under **Network Access**, click **Personal Hotspot**. The **Personal Hotspot Policy** information page appears.
4. In the **Policy Information** pane, enter the following information:
 - **Policy Name:** Type a descriptive name for the policy.
 - **Description:** Optionally, type a description of the policy.
5. Click **Next**. The **iOS Platform** information page appears.

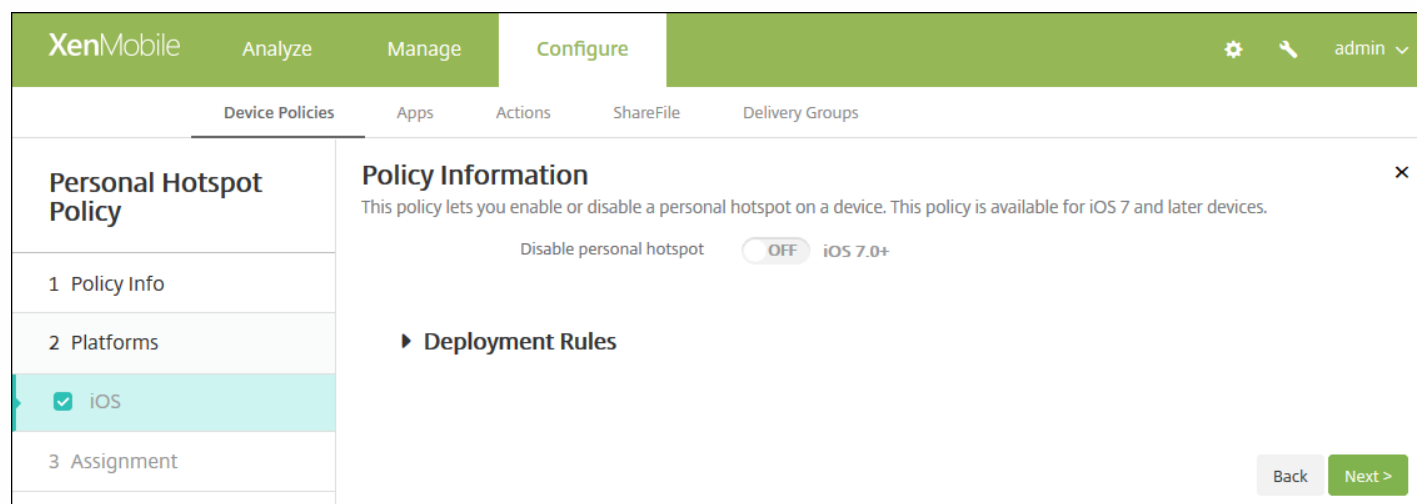

The screenshot shows the XenMobile console interface. The top navigation bar includes 'XenMobile', 'Analyze', 'Manage', and 'Configure' (which is active). On the right of the navigation bar are icons for settings, search, and a user profile labeled 'admin'. Below the navigation bar, there are tabs for 'Device Policies', 'Apps', 'Actions', 'ShareFile', and 'Delivery Groups'. The 'Device Policies' tab is selected, and a sidebar on the left shows a list of policy steps: '1 Policy Info', '2 Platforms', '3 Assignment', and '4 iOS' (which is highlighted in light blue). The main content area is titled 'Personal Hotspot Policy' and contains a 'Policy Information' section with a close button (X). The text in this section reads: 'This policy lets you enable or disable a personal hotspot on a device. This policy is available for iOS 7 and later devices.' Below this text is a toggle switch for 'Disable personal hotspot' which is currently set to 'OFF', followed by the text 'iOS 7.0+'. A 'Deployment Rules' section is partially visible below. At the bottom right of the main content area, there are 'Back' and 'Next >' buttons.

6. Configure this setting:
 - **Disable personal hotspot:** Select whether to disable the personal hotspot functionality on users' devices. The default is **OFF**, which switches off the personal hotspot on users devices. This policy does not disable the functionality; users can still use the personal hotspot on their devices, but when the policy is deployed, the personal hotspot is turned off so that it doesn't remain on by default.
7. Configure deployment rules and choose delivery groups. For more information, see [Add a device policy](#).

Profile Removal device policy

Jun 19, 2017

You can create an app profile removal device policy in XenMobile. The policy, when deployed, removes the app profile from users' iOS or Mac OS X devices.

1. In the XenMobile console, click **Configure** > **Device Policies**. The Device Policies page appears.
 2. Click **Add**. The **Add New Policy** dialog box appears.
 3. Expand **More** and then, under **Removal**, click **Profile Removal**. The **Profile Removal Policy** information page appears.
 4. In the **Policy Information** pane, type the following information:
 - **Policy Name:** Type a descriptive name for the policy.
 - **Description:** Type an optional description of the policy.
 5. Click **Next**. The **Platforms** page appears.
 6. Under **Platforms**, select the platforms you want to add. If you are only configuring for one platform, clear the others.
- When you finish configuring the settings for a platform, refer to Step 7 for how to set that platform's deployment rules.

The screenshot shows the XenMobile console interface. The top navigation bar includes 'XenMobile', 'Analyze', 'Manage', and 'Configure'. The 'Configure' section is active, showing 'Device Policies' as the selected category. The main content area is titled 'Profile Removal Policy' and contains a 'Policy Information' pane. This pane includes a description, a 'Profile ID*' field with a dropdown menu (showing 'This field is mandatory.'), and a 'Comment' text input field. Below this is a 'Deployment Rules' section. On the left, a sidebar shows the policy configuration steps: '1 Policy Info', '2 Platforms', and '3 Assignment'. The '2 Platforms' step is expanded, showing 'iOS' and 'Mac OS X' both selected with checkmarks. At the bottom right of the main content area, there are 'Back' and 'Next >' buttons.

Configure these settings:

- **Profile ID:** In the list, click the app profile ID. This field is required.
- **Comment:** Type an optional comment.

The screenshot shows the XenMobile configuration interface. At the top, there are navigation tabs: Analyze, Manage, and Configure (selected). Below these are sub-tabs: Device Policies, Apps, Actions, ShareFile, and Delivery Groups. The main content area is titled 'Profile Removal Policy' and contains a sidebar with three sections: '1 Policy Info', '2 Platforms', and '3 Assignment'. Under '2 Platforms', both 'iOS' and 'Mac OS X' are checked. The 'Mac OS X' option is highlighted. The main area is titled 'Policy Information' and includes a description: 'This policy lets you remove a profile for iOS or Mac OS X from a device.' Below this are three fields: 'Profile ID*' with a dropdown menu showing 'This field is mandatory.', 'Deployment scope' with a dropdown menu showing 'User' and a note 'OS X 10.7+', and a 'Comment' text input field. At the bottom right, there are 'Back' and 'Next >' buttons.

Configure these settings:

- **Profile ID:** In the list, click the app profile ID. This field is required.
- **Deployment scope:** In the list, click either **User** or **System**. The default is **User**. This option is available only on OS X 10.7 and later.
- **Comment:** Type an optional comment.

7. Configure deployment rules and choose delivery groups. For more information, see [Add a device policy](#).

Provisioning profile device policy

Jun 19, 2017

When you develop and code sign an iOS enterprise app, you usually include an enterprise distribution provisioning profile, which Apple requires for the app to run on an iOS device. If a provisioning profile is missing or has expired, the app crashes when a user taps to open it.

The primary problem with provisioning profiles is that they expire one year after they are generated on the Apple Developer Portal and you must keep track of the expiration dates for all your provisioning profiles on all iOS devices enrolled by your users. Tracking the expiration dates not only involves keeping track of the actual expiration dates, but also which users are using which version of the app. Two solutions are to email provisioning profiles to users or to put them on a web portal for download and installation. These solutions work, but they are prone to error because they require users to react to instructions in an email or to go to the web portal and download the correct profile and then install it.

To make this process transparent to users, in XenMobile you can install and remove provisioning profiles with device policies. Missing or expired profiles are removed as necessary and the up-to-date profiles are installed on users' devices, so that tapping an app simply opens it for use.

Before you can create a provisioning profile policy, you must create a provisioning profile file. For more information, see [Creating Provisioning Profiles](#) on the Apple Developer site.

1. In the XenMobile console, click **Configure** > **Device Policies**. The **Device Policies** page appears.
2. Click **Add**. The **Add a New Policy** page appears.
3. Expand **More** and then, under **Apps**, click **Provisioning Profile**. The **Provisioning Profile Policy** information page appears.

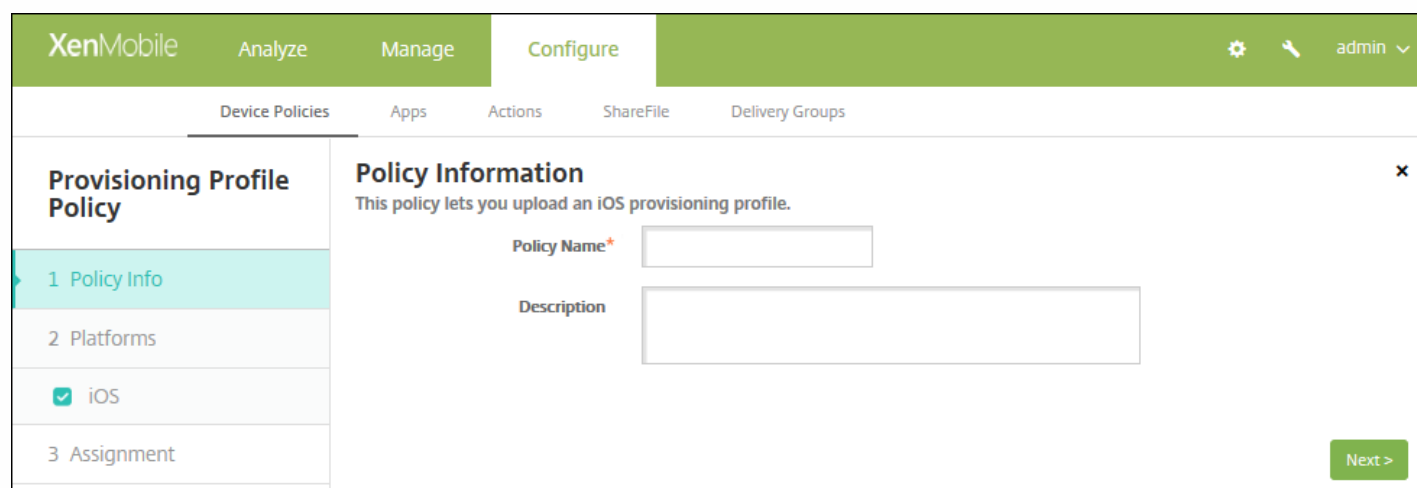

The screenshot shows the XenMobile console interface. The top navigation bar includes 'XenMobile', 'Analyze', 'Manage', and 'Configure'. The 'Configure' section is active, showing a breadcrumb trail: 'Device Policies' > 'Apps' > 'Actions' > 'ShareFile' > 'Delivery Groups'. The main content area is titled 'Provisioning Profile Policy' and contains a 'Policy Information' pane. This pane includes a sub-header 'Policy Information' and a description: 'This policy lets you upload an iOS provisioning profile.' Below this, there are two input fields: 'Policy Name*' and 'Description'. A 'Next >' button is located at the bottom right of the pane. On the left side of the main content area, there is a sidebar with three items: '1 Policy Info' (selected), '2 Platforms', and '3 Assignment'. The 'iOS' platform is checked under the '2 Platforms' section.

4. In the **Policy Information** pane, enter the following information:

- **Policy Name:** Type a descriptive name for the policy.
- **Description:** Optionally, type a description of the policy.

5. Click **Next**. The **iOS Platform** information page appears.

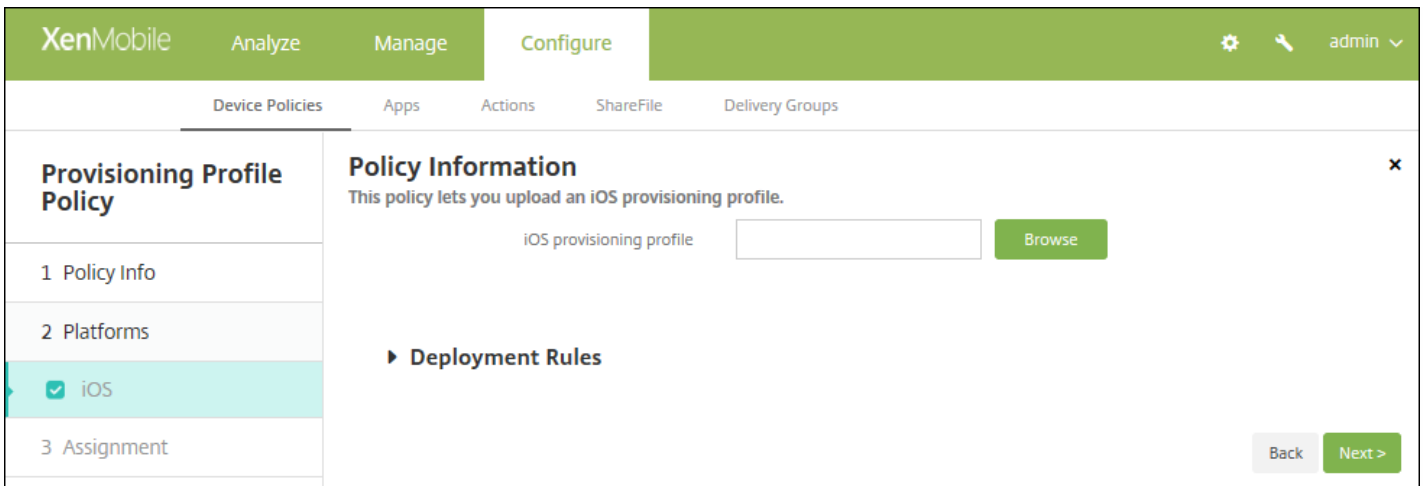

6. Configure this setting:

- **iOS provisioning profile:** Select the provisioning profile file to import by clicking **Browse** and then navigating to the file's location.

8. Click **Next**. The **Provisioning Profile Policy** assignment page appears.

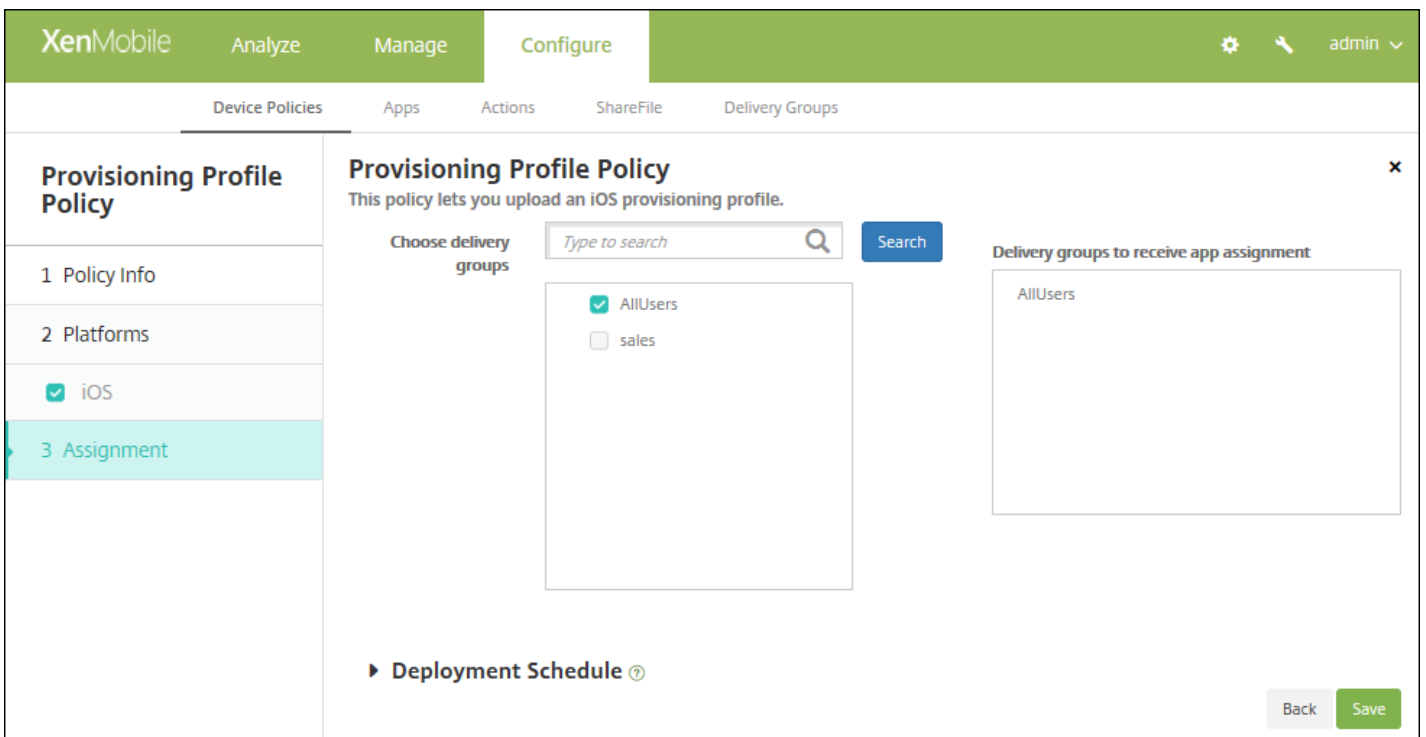

9. Next to **Choose delivery groups**, type to find a delivery group or select a group or groups in the list to which you want to assign the policy. The groups you select appear in the **Delivery groups to receive app assignment** list.

10. Expand **Deployment Schedule** and then configure the following settings:

- Next to **Deploy**, click **ON** to schedule deployment or click **OFF** to prevent deployment. The default option is **ON**. If you choose **OFF**, no other options need to be configured.
- Next to **Deployment schedule**, click **Now** or **Later**. The default option is **Now**.
- If you click **Later**, click the calendar icon and then select the date and time for deployment.
- Next to **Deployment condition**, click **On every connection** or click **Only when previous deployment has failed**. The default option is **On every connection**.
- Next to **Deploy for always-on connection**, click **ON** or **OFF**. The default option is **OFF**.

Note:

- This option applies when you have configured the scheduling background deployment key in **Settings >Server Properties**. The always-on option is not available for iOS devices.
- The deployment schedule you configure is the same for all platforms. Any changes you make apply to all platforms, except for **Deploy for always on connection**, which does not apply to iOS.

11. Click **Save**.

Provisioning profile removal device policy

Jun 19, 2017

You can remove iOS provisioning profiles with device policies. For more information on provisioning profiles, see [adding a provisioning profile](#).

1. In the XenMobile console, click **Configure** > **Device Policies**. The **Device Policies** page appears.
2. Click **Add**. The **Add a New Policy** page appears.
3. Expand **More** and then, under **Removal**, click **Provisioning Profile removal**. The **Provisioning Profile Removal Policy** information page appears.

The screenshot shows the XenMobile console interface. The top navigation bar includes 'XenMobile', 'Analyze', 'Manage', and 'Configure'. Below this, there are tabs for 'Device Policies', 'Apps', 'Actions', 'ShareFile', and 'Delivery Groups'. The main content area is titled 'Provisioning Profile Removal Policy' and contains a 'Policy Information' section. This section has a description: 'This policy lets remove a provisioning profile from an iOS device.' There are two input fields: 'Policy Name*' and 'Description'. A 'Next >' button is located at the bottom right of the form.

4. In the **Policy Information** pane, enter the following information:

- **Policy Name:** Type a descriptive name for the policy.
- **Description:** Optionally, type a description of the policy.

5. Click **Next**. The **iOS Platform** page appears.

The screenshot shows the XenMobile console interface. The top navigation bar includes 'XenMobile', 'Analyze', 'Manage', and 'Configure'. Below this, there are tabs for 'Device Policies', 'Apps', 'Actions', 'ShareFile', and 'Delivery Groups'. The main content area is titled 'Provisioning Profile Removal Policy' and contains a description: 'This policy lets remove a provisioning profile from an iOS device.' There are two input fields: 'iOS provisioning profile*' (a dropdown menu) and 'Comment'. A 'Deployment Rules' section is visible below. 'Back' and 'Next >' buttons are located at the bottom right of the form.

6. Configure these settings:

- **iOS provisioning profile:** In the list, click the provisioning profile you want to remove.
- **Comment:** Optionally, add a comment.

8. Click **Next**. The **Provisioning Profile Removal Policy** assignment page appears.

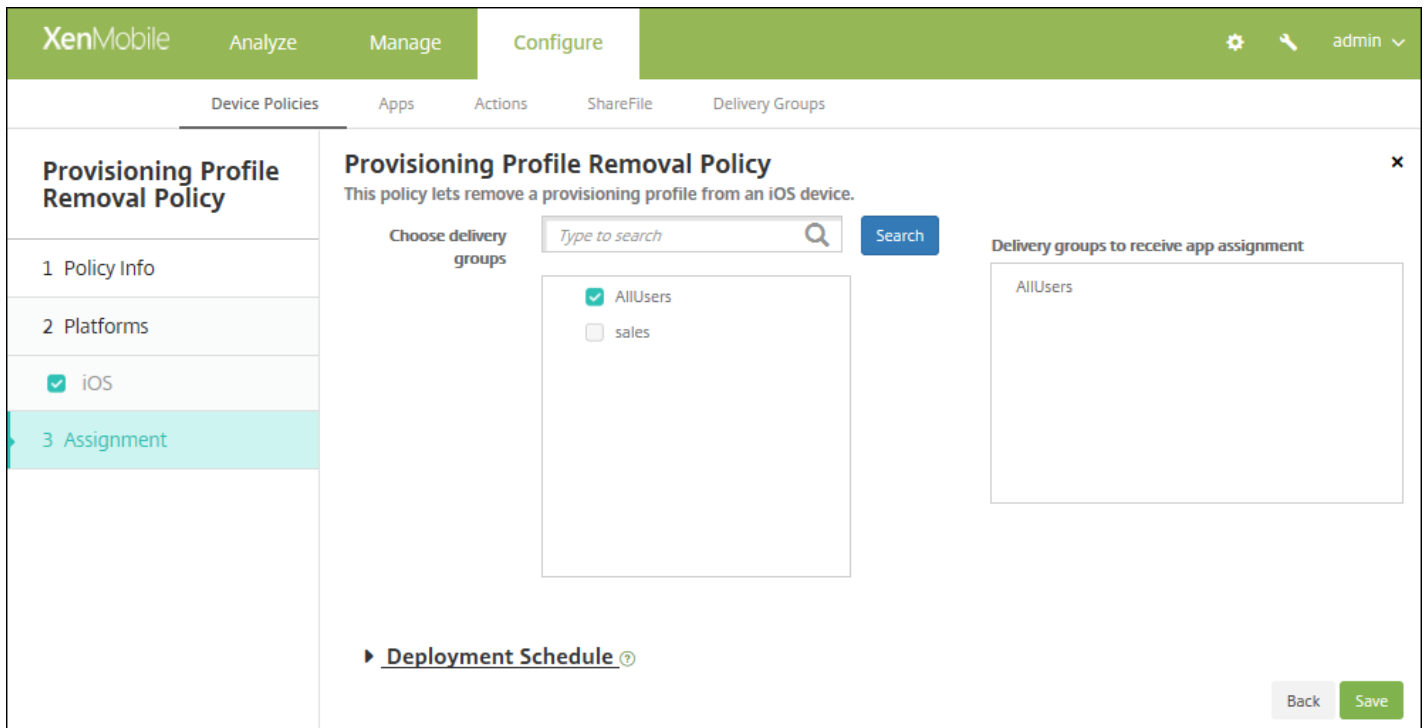

9. Next to **Choose delivery groups**, type to find a delivery group or select a group or groups in the list to which you want to assign the policy. The groups you select appear in the **Delivery groups to receive app assignment** list.

10. Expand **Deployment Schedule** and then configure the following settings:

- Next to **Deploy**, click **ON** to schedule deployment or click **OFF** to prevent deployment. The default option is **ON**. If you choose **OFF**, no other options need to be configured.
- Next to **Deployment schedule**, click **Now** or **Later**. The default option is **Now**.
- If you click **Later**, click the calendar icon and then select the date and time for deployment.
- Next to **Deployment condition**, click **On every connection** or click **Only when previous deployment has failed**. The default option is **On every connection**.
- Next to **Deploy for always-on connection**, click **ON** or **OFF**. The default option is **OFF**.

Note:

- This option applies when you have configured the scheduling background deployment key in **Settings > Server Properties**. The always-on option is not available for iOS devices.
- The deployment schedule you configure is the same for all platforms. Any changes you make apply to all platforms, except for **Deploy for always on connection**, which does not apply to iOS.

11. Click Save.

Proxy device policy

Jun 19, 2017

You can add a device policy in XenMobile to specify global HTTP proxy settings for devices running Windows Mobile/CE and iOS 6.0 or later. You can deploy only one global HTTP proxy policy per device.

Note: Before deploying this policy, be sure to set all iOS devices for which you want to set a global HTTP proxy into Supervised mode. For details, see [To place an iOS device in Supervised mode by using the Apple Configurator](#).

1. In the XenMobile console, click **Configure** > **Device Policies**. The **Device Policies** page appears.
2. Click **Add**. The **Add a New Policy** dialog box appears.
3. Click **More** and then, under **Network access**, click **Proxy**. The **Proxy Policy** page appears.

The screenshot shows the XenMobile console interface. At the top, there's a navigation bar with 'XenMobile', 'Analyze', 'Manage', and 'Configure' (highlighted). Below that, there are tabs for 'Device Policies', 'Apps', 'Actions', 'ShareFile', and 'Delivery Groups'. The main content area is titled 'Proxy Policy' and has a sidebar on the left with three sections: '1 Policy Info' (highlighted), '2 Platforms', and '3 Assignment'. Under '2 Platforms', there are two checked items: 'iOS' and 'Windows Mobile/CE'. The main area is titled 'Policy Information' and contains a description: 'This policy lets you configure a single, or global, HTTP proxy to be used by all apps that send traffic through HTTP. For iOS, the policy is available for iOS 6. You must also set the iOS device into supervised mode.' Below the description are two input fields: 'Policy Name*' (a text box) and 'Description' (a larger text area). At the bottom right of the main area, there is a green button labeled 'Next >'.

4. In the **Policy Information** pane, enter the following information:

- **Policy Name:** Enter a descriptive name for the policy.
- **Description:** Optionally, enter a description of the policy.

5. Click **Next**. The **Policy Platforms** page appears.

6. Under **Platforms**, select the platforms you want to add. If you are only configuring for one platform, clear the others.

When you finish configuring the settings for a platform, refer to Step 7 for how to set that platform's deployment rules.

Proxy Policy

1 Policy Info

2 Platforms

iOS

Windows Mobile/CE

3 Assignment

Policy Information

This policy lets you configure a single, or global, HTTP proxy to be used by all apps that send traffic through HTTP. For iOS, the policy is available for iOS 6. You must also set the iOS device into supervised mode.

Proxy configuration: Manual

Host name or IP address for the proxy server*

Port for the proxy server*

User name

Password

Allow bypassing proxy to access captive networks: OFF

Policy Settings

Remove policy: Select date, Duration until removal (in days)

Allow user to remove policy: Always

► Deployment Rules

Back Next >

Configure these settings:

- **Proxy configuration:** Click **Manual** or **Automatic** for how the proxy will be configured on users' devices.
 - If you click **Manual**, configure these settings:
 - **Hostname or IP address for the proxy server:** Type the host name or IP address of the proxy server. This field is required.
 - **Port for the proxy server:** Type the proxy server port number. This field is required.
 - **User name:** Type an optional user name to authenticate to the proxy server.
 - **Password:** Type an optional password to authenticate to the proxy server.
 - If you click **Automatic**, configure these settings:
 - **Proxy PAC URL:** Type URL of the PAC file that defines the proxy configuration.
 - **Allow direct connection if PAC is unreachable:** Select whether to allow users to connect directly to the destination if the PAC file is unreachable. The default is **ON**. This option is available only on iOS 7.0 and later.
- **Allow bypassing proxy to access captive networks:** Select whether to allow bypassing the proxy to access captive networks. The default is **OFF**.
- **Policy Settings**
 - Next to **Remove policy**, click either **Select date** or **Duration until removal (in hours)**.
 - If you click **Select date**, click the calendar to select the specific date for removal.
 - In the **Allow user to remove policy** list, click **Always**, **Password required**, or **Never**.
 - If you click **Password required**, next to **Removal password**, type the necessary password.

The screenshot shows the XenMobile configuration interface. At the top, there are tabs for 'Analyze', 'Manage', and 'Configure'. Below these are sub-tabs for 'Device Policies', 'Apps', 'Actions', 'ShareFile', and 'Delivery Groups'. The 'Proxy Policy' section is active, showing a sidebar with '1 Policy Info', '2 Platforms' (with 'iOS' and 'Windows Mobile/CE' checked), and '3 Assignment'. The main content area is titled 'Policy Information' and includes a description: 'This policy lets you configure a single, or global, HTTP proxy to be used by all apps that send traffic through HTTP. For iOS, the policy is available for iOS 6. You must also set the iOS device into supervised mode.' Below this are several configuration fields: 'Network' (set to 'Built-in office'), another 'Network' (set to 'HTTP'), 'Host name or IP address for the proxy server' (empty), 'Port for the proxy server' (set to '80'), 'User name' (empty), 'Password' (empty), 'Domain name' (empty), and an 'Enable' toggle switch (set to 'ON'). At the bottom right, there are 'Back' and 'Next >' buttons.

Configure these settings:

- **Network:** In the list, click the network type to use. The default is **Built-in office**. Possible options are:
 - User-defined office
 - User-defined Internet
 - Built-in office
 - Built-in Internet
- **Network:** In the list, click the network connection protocol to use. The default is **HTTP**. Possible options are:
 - HTTP
 - WAP
 - Socks 4
 - Socks 5
- **Hostname or IP address for the proxy server:** Type the host name or IP address of the proxy server. This field is required.
- **Port for the proxy server:** Type the proxy server port number. This field is required. The default is **80**.
- **User name:** Type an optional user name to authenticate to the proxy server.
- **Password:** Type an optional password to authenticate to the proxy server.
- **Domain name:** Type an optional domain name.
- **Enable:** Select whether to enable the proxy. The default is **ON**.

8. Click **Next**. The **Proxy Policy** assignment page appears.

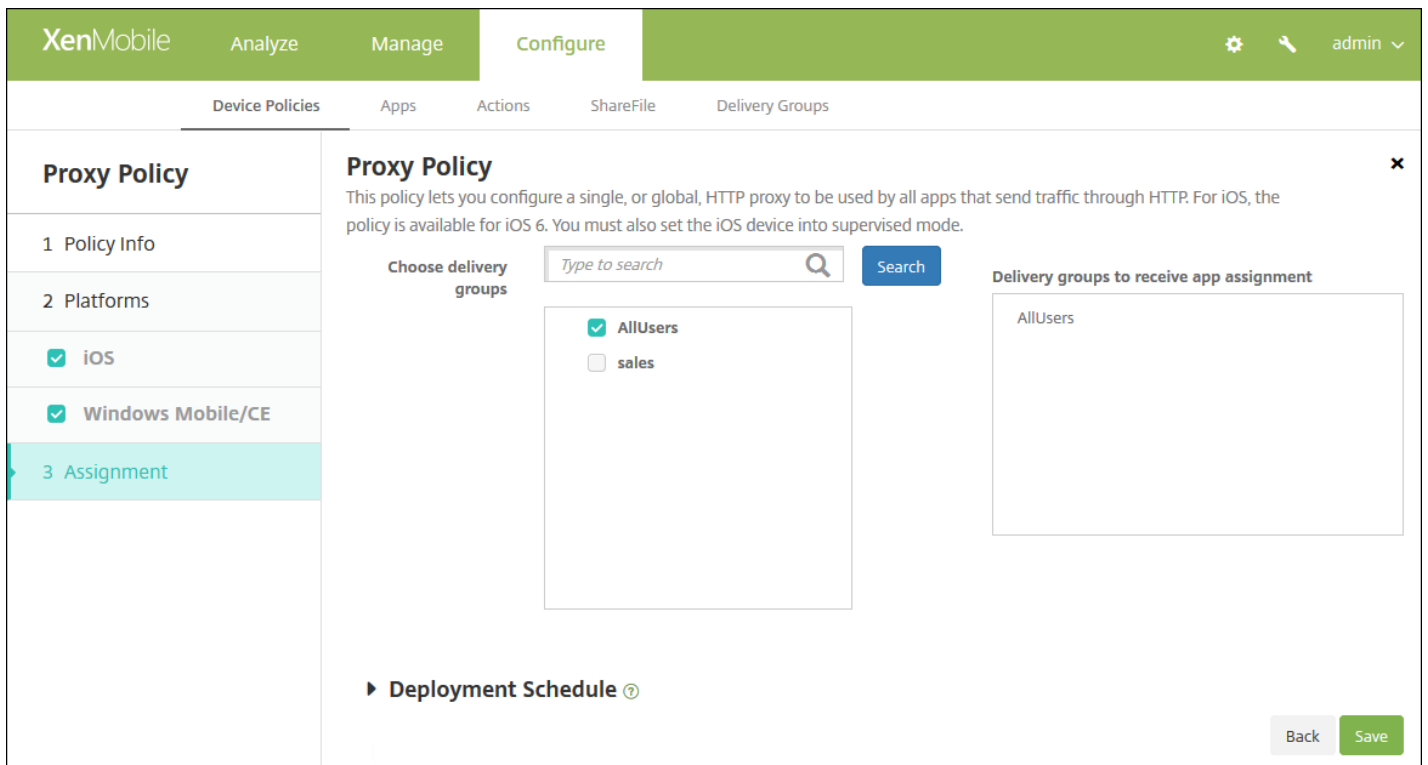

9. Next to **Choose delivery groups**, type to find a delivery group or select a group or groups in the list to which you want to assign the policy. The groups you select appear in the right-hand **Delivery groups to receive app assignment** list.

10. Expand **Deployment Schedule** and then configure the following settings:

- Next to **Deploy**, click **ON** to schedule deployment or click **OFF** to prevent deployment. The default option is **ON**. If you choose **OFF**, no other options need to be configured.
- Next to **Deployment schedule**, click **Now** or **Later**. The default option is **Now**.
- If you click **Later**, click the calendar icon and then select the date and time for deployment.
- Next to **Deployment condition**, click **On every connection** or click **Only when previous deployment has failed**. The default option is **On every connection**.
- Next to **Deploy for always-on connection**, click **ON** or **OFF**. The default option is **OFF**.

Note:

- This option applies when you have configured the scheduling background deployment key in **Settings > Server Properties**. The always-on option is not available for iOS devices.
- The deployment schedule you configure is the same for all platforms. Any changes you make apply to all platforms, except for **Deploy for always on connection**, which does not apply to iOS.

11. Click **Save**.

Registry device policy

Jun 19, 2017

The Windows Mobile/CE registry stores data about apps, drivers, user preferences, and configuration settings. In XenMobile, you can define the registry keys and values that let you administer Windows Mobile/CE devices.

1. In the XenMobile console, click **Configure** > **Device Policies**. The **Device Policies** page appears.
2. Click **Add**. The **Add a New Policy** dialog box appears.
3. Expand **More** and then, under **Custom**, click **Registry**. The **Registry Policy** information page appears.
4. In the **Policy Information** pane, type the following information:
 - **Policy Name:** Type a descriptive name for the policy.
 - **Description:** Type an optional description of the policy.
5. Click **Next**. The **Windows Mobile/CE Platform** page appears.

The screenshot shows the XenMobile console interface. The top navigation bar includes 'XenMobile', 'Analyze', 'Manage', and 'Configure'. The 'Configure' section is active, showing 'Device Policies', 'Apps', 'Actions', 'ShareFile', and 'Delivery Groups'. The 'Registry Policy' page is displayed, with a sidebar on the left containing '1 Policy Info', '2 Platforms', '3 Assignment', and '4 Windows Mobile/CE'. The main content area is titled 'Policy Information' and includes a description: 'This policy allows you to specify which registry keys and values need to be defined on the device. An empty value means that the entry is a registry key.' Below this is a table with columns for 'Registry key path*', 'Registry value name', 'Type', and 'Value', and an 'Add' button. A 'Deployment Rules' section is also visible, along with 'Back' and 'Next >' buttons at the bottom right.

6. Configure these settings:
 - For each registry key or registry key/value pair you want to add, click **Add** and do the following:
 - **Registry key path:** Type the full path for the registry key. For example, type `HKEY_LOCAL_MACHINE\Software\Microsoft\Windows` to specify the route to the Windows key from the HKEY_LOCAL_MACHINE root key.
 - **Registry value name:** Type the name for the registry key value. For example, type `ProgramFilesDir` to add that value name to the registry key path `HKEY_LOCAL_MACHINE\Software\Microsoft\Windows\CurrentVersion`. If you leave this field blank, it means that you are adding a registry key and not a registry key/value pair.
 - **Type:** In the list, click the data type for the value. The default is **DWORD**. Possible options are:
 - **DWORD:** A 32-bit unsigned integer.
 - **String:** Any string.
 - **Extended string:** A string value that can contain environment variables like `%TEMP%` or `%USERPROFILE%`.
 - **Binary:** Any arbitrary binary data.
 - **Value:** Type the value associated with Registry value name. For example, to specify the value of `ProgramFilesDir`, type

C:\Program Files.

- Click **Save** to save the registry key information or click **Cancel** to not save the registry key information.

Note: To delete an existing registry key, hover over the line containing the listing and then click the trash can icon on the right-hand side. A confirmation dialog box appears. Click **Delete** to delete the listing or **Cancel** to keep the listing.

To edit an existing registry key, hover over the line containing the listing and then click the pen icon on the right-hand side. Make any changes to the listing and then click **Save** to save the changed listing or **Cancel** to leave the listing unchanged.

7. Configure deployment rules and choose delivery groups. For more information, see [Add a device policy](#).

Remote support device policy

Jun 19, 2017

You create a remote support policy in XenMobile to give you remote access to users' Samsung KNOX devices. You can configure two types of support:

- **Basic**, which lets you view diagnostic information about the device, such as system information, processes that are running, task manager (memory and CPU usage), installed software folder contents, and so on.
- **Premium**, which lets you remotely control the device's screen, including control over colors (in either the main window, or in a separate, floating window), the ability to establish a Voice-over-IP session (VoIP) between the help desk and the user, to configure settings, and to establish a chat session between the help desk and the user.

Note: To implement this policy, you must do the following:

- Install the XenMobile Remote Support app in your environment.
- Configure a remote support app tunnel. For details, see [App tunneling device policies](#).
- Configure a Samsung KNOX remote support device policy as described in this topic.
- Deploy both the app tunnel remote support policy and the Samsung KNOX remote support policy to users' devices.

1. In the XenMobile console, click **Configure** > **Device Policies**. The **Device Policies** page appears.

2. Click **Add**. The **Add a New Policy** dialog box appears.

3. Expand **More** and then, under **Network access**, click **Remote Support**. The **Remote Support Policy** page appears.

4. In the **Policy Information** pane, enter the following information:

- **Policy Name**: Type a descriptive name for the policy.
- **Description**: Optionally, type a description of the policy.

5. Click **Next**. The **Samsung KNOX** platform information page appears.

The screenshot shows the XenMobile console interface. The top navigation bar includes 'XenMobile', 'Analyze', 'Manage', and 'Configure'. Below this, there are tabs for 'Device Policies', 'Apps', 'Actions', 'ShareFile', and 'Delivery Groups'. The main content area is titled 'Remote Support Policy' and contains a 'Policy Information' section with a description: 'This policy lets you enable premium remote support on Samsung KNOX devices to let administrators troubleshoot devices remotely.' Below this, there are radio buttons for 'Remote support' with 'Basic remote support' selected and 'Premium remote support' unselected. There is also a 'Deployment Rules' section. At the bottom right, there are 'Back' and 'Next >' buttons.

6. Configure this setting:

- **Remote support**: Select **Basic remote support** or **Premium remote support**. The default is **Basic remote support**.

7. Configure deployment rules and choose delivery groups. For more information, see [Add a device policy](#).

Restrictions device policy

Jun 27, 2017

The Restrictions device policy allows or restricts certain features or functionality on user devices, such as the camera. You can also set security restrictions, as well as restrictions on media content and restrictions on the types of apps users can and cannot install. Most of the restriction settings default to **ON**, or *allows*. The main exceptions are the iOS Security - Force feature and all Windows Tablet features, which default to **OFF**, or *restricts*.

Tip: Any option for which you select **ON** means that the user can perform the operation or use the feature. For example:

- **Camera.** If **ON**, the user can use the camera on their device. If **OFF**, the user cannot use the camera on their device.
- **Screen shots.** If **ON**, the user can take screen shots on their device. If **OFF**, the user cannot take screen shots on their device.

Note

For Windows 10 RS2 Phone: After a Custom XML policy or Restrictions policy that disables Internet Explorer deploys to the phone, the browser remains enabled. To work around this issue, restart the phone. This is a third-party issue.

1. In the XenMobile console, click **Configure > Device Policies**. The **Device Policies** page appears.
2. Click **Add**. The **Add a New Policy** page appears.
3. Click **Restrictions**. The restrictions **Policy information** page appears.
4. In the **Policy Information** pane, type the following information:
 - **Policy Name:** Type a descriptive name for the policy.
 - **Description:** Type an optional description of the policy.
4. Click **Next**. The **Policy Platforms** page appears.
5. Under **Platforms**, select the platform or platforms you want to add. You can then change the policy information for each platform you selected. Click to restrict any of the features in the following sections, which changes the setting to **OFF**. Unless otherwise noted, the default setting is to enable the feature.

If you selected:

[iOS, configure these settings](#)

[Mac OS X, configure these settings](#)

[Samsung SAFE, configure these settings](#)

[Samsung KNOX, configure these settings](#)

[Windows Phone, configure these settings](#)

[Windows Tablet, configure these settings](#)

[Amazon, configure these settings](#)

[Windows Mobile/CE, configure these settings](#)

When you finish setting the restrictions for a platform, refer to Step 7 later in this article for how to set that platform's deployment rules.

XenMobile Analyze Manage **Configure** administrator

Device Policies Apps Actions ShareFile Enrollment Profiles Delivery Groups

Restrictions Policy

This policy allows or restricts users from using certain features on their devices, such as the camera. You can also set security restrictions, as well as restrictions on media content and on certain types of apps users can and cannot install.

Allow hardware controls

- Camera: ON
- FaceTime: ⓘ
- Screen shots: ON
- Photo streams: ON iOS 5.0+
- Shared photo streams: ON iOS 6.0+
- Voice dialing: ON
- Siri: ON
 - Allow while device is locked
 - Siri profanity filter
- Installing apps: ON ⓘ
- Allow global background fetch while roaming: ON

1 Policy Info

2 Platforms

- iOS
- Mac OS X
- Samsung SAFE
- Samsung KNOX
- Windows Phone
- Windows Desktop/Tablet
- Amazon
- Windows Mobile/CE

3 Assignment

Note: Some of the iOS restrictions options apply only to specific versions of iOS (and, where applicable, these versions are noted on the XenMobile console page). For example, the capability to allow or block AirDrop is only supported on devices running iOS 7 and later. The capability to allow or block Photo streams is supported on devices running iOS 5 and later. Also, some options only apply if the device is placed in supervised mode. For the steps on setting an iOS device to supervised mode, see [To place an iOS device in Supervised mode by using the Apple Configurator](#).

- **Allow hardware controls**

- **Camera:** Allow users to use the camera on their devices.
 - **FaceTime:** Allow users to use FaceTime on their devices. This restriction is deprecated on unsupervised iOS 10 devices.
- **Screen shots:** Allow users to take screen shots on their devices.
- **Photo streams:** Allow users to use MyPhotoStream to share photos through iCloud to all their iOS devices (iOS 5.0 and later).
- **Shared photo streams:** Allow users to use iCloud Photo Sharing to share photos with coworkers, friends, and family (iOS 6.0 and later).
- **Voice dialing:** Enables voice dialing on user devices.
- **Siri:** Allows users to use Siri.
 - **Allow while device is locked:** Allow users to use Siri while their devices are locked.
 - **Siri profanity filter:** Enable the Siri profanity filter. The default is to restrict this feature, which means no profanity filtering is done.

For more information about Siri and security, see [Siri and dictation policies](#).

- **Installing apps:** Allow users to install apps. This restriction is deprecated on unsupervised iOS 10 devices.
- **Allow global background fetch while roaming:** Allow devices to automatically sync mail accounts to iCloud while the

device is roaming. When **OFF**, disables global background fetch activity when an iOS phone is roaming. Defaults to **ON**.

- **Allow apps**

- **iTunes Store**: Allow users to access the iTunes Store. This restriction is deprecated on unsupervised iOS 10 devices.
- **In-app purchases**: Allow users to make in-app purchases.
 - **Require iTunes password for purchases**: Require a password for in-app purchases. The default is to restrict this feature, which means no password is required for in-app purchases (iOS 5.0 and later).
- **Safari**: Allow users to access Safari. This restriction is deprecated on unsupervised iOS 10 devices.
 - **Autofill**: Allow users to set up autofill for user names and passwords on Safari.
 - **Force fraud warning**: If this setting is enabled and users visit a suspected phishing website, Safari alerts users. The default is to restrict this feature, which means no warnings are issued.
 - **Enable JavaScript**: Allow JavaScript to run on Safari.
 - **Block pop-ups**: Block pop-ups while viewing websites. The default is to restrict this feature, which means pop-ups are not blocked.
- **Accept cookies**: Set to what extent cookies are accepted. In the list, choose an option to allow or restrict cookies. The default option is **Always**, which allows all websites to save cookies in Safari. Other options are **Current website only**, **Never**, and **From visited sites only**.

- **Network - Allow iCloud actions**

- **iCloud documents and data**: Allow users to sync documents and data to iCloud (iOS 5.0 and later). This restriction is deprecated on unsupervised iOS 10 devices.
- **iCloud backup**: Allow users to back up their devices to iCloud (iOS 5.0 and later).
- **iCloud keychain**: Allow users to store passwords, WiFi network, credit card, and other information in the iCloud Keychain (iOS 7.0 and later).
- **Cloud photo library**: Allow users to access their iCloud photo library (iOS 9.0 and later).

- **Security - Force**

The default is to restrict the following features, which means no security features are enabled.

- **Encrypted backups**: Force backups to iCloud to be encrypted.
- **Limited ad tracking**: Block targeted ad tracking (iOS 7.0 and later).
- **Passcode on first AirPlay pairing**: Require that AirPlay-enabled devices are verified with a one-time onscreen code before they can use AirPlay (iOS 7.0 and later).
- **Paired Apple Watch to use Wrist Detection**: Require a paired Apple Watch to use **Wrist Detection** (iOS 8.2 and later).
- **Sharing managed documents using AirDrop**: AirDrop access is a supervised option. Setting this option to **ON** allows supervised devices to use AirDrop to share data and media with nearby iOS devices (iOS 9.0 and later).

- **Security - Allow**

- **Accepting untrusted SSL certificates**: Allow users to accept web sites' untrusted SSL certificates (iOS 5.0 and later).
- **Automatic update to certificate trust settings**: Allow trusted certificates to be updated automatically (iOS 7.0 and later).
- **Documents from managed apps in unmanaged apps**: Allow users to move data from managed (corporate) apps to unmanaged (personal) apps.
- **Documents from unmanaged apps in managed apps**: Allow users to move data from unmanaged (personal) apps to managed (corporate) apps.
- **Diagnostic submission to Apple**: Allow anonymous diagnostic data about users' devices to be sent to Apple.
- **Touch ID to unlock device**: Allow users to use their fingerprints to unlock their devices (iOS 7.0 and later).
- **Passbook notifications when locked**: Allow Passbook notifications to appear on the lock screen (iOS 6.0 and later).
- **Handoff**: Allow users to transfer activities from one iOS device to another nearby iOS device (iOS 8.0 and later).
- **iCloud sync for managed apps**: Allow users to sync managed apps to iCloud (iOS 8.0 and later).
- **Backup for enterprise books**: Allow enterprise books to be backed up to iCloud (iOS 8.0 and later).
- **Notes and highlights sync for enterprise books**: Allow notes and highlights users have added to enterprise books to be synced to iCloud (iOS 8.0 and later).
- **Enterprise app trust**: Allow enterprise applications to be trusted (iOS 9.0 and later).
- **Internet results in Spotlight**: Allow Spotlight to show search results from the Internet as well as the device (iOS 8.0 and later).

- **Supervised only settings - Allow**

These settings apply only to supervised devices. For the steps on setting an iOS device to supervised mode, see [To place an iOS device in Supervised mode by using the Apple Configurator](#).

- **Erase all content and settings:** Allow users to erase all content and settings from their devices (iOS 8.0 and later).
- **Configuring restrictions:** Allow users to configure parental controls on their devices (iOS 8.0 and later).
- **Podcasts:** Allow users to download and sync podcasts (iOS 8.0 and later).
- **Installing configuration profiles:** Allow users to install a configuration profile other than that the one deployed by you (iOS 6.0 and later).
- **Fingerprint modification:** Allow users to change or delete their Touch ID fingerprint (iOS 8.3 and later).
- **Installing apps from device:** (iOS 9.0 and later).
- **Keyboard shortcuts:** Allow users to create custom keyboard shortcuts for words or phrases that they use often (iOS 9.0 and later).
- **Paired Apple watch:** Allow users to pair an Apple Watch to a supervised device (iOS 9.0 and later).
- **Passcode modification:** Allow users to change the passcode on a supervised device (iOS 9.0 and later).
- **Device name modification:** Allow users to change the name of their device.
- **Wallpaper modification:** Allow user to change the wallpaper on their devices (iOS 9.0 and later).
- **Automatically downloading apps** (iOS 9.0 and later).
- **AirDrop:** Allow users to share photos, videos, websites, locations, and more with nearby iOS devices (iOS 7.0 and later).
- **iMessage:** Allow users to text over Wi-Fi with iMessage (iOS 6.0 and later).
- **Siri user-generated content:** Allow Siri to query user-generated content from the web. Consumers, not traditional journalists; produce user-generated content. For example, content found on Twitter or Facebook is user-generated. (iOS 7.0 and later).
- **iBooks:** Allow users to use the iBooks app (iOS 6.0 and later).
- **Removing apps:** Allow users to remove apps from their devices (iOS 7.0 and later).
- **Game Center:** Allow users to play online games through Game Center on their devices (iOS 6.0 and later).
 - **Add friends:** Allow users to send a notification to a friend to play a game.
 - **Multiplayer gaming:** Allow users to start multiplayer game play on their devices.
- **Modifying account settings:** Allow users to modify their device account settings (iOS 7.0 and later).
- **Modifying app cellular data settings:** Allow users to modify how apps use cellular data (iOS 7.0 and later).
- **Modifying Find My Friends settings:** Allow users to change their Find My Friends settings (iOS 7.0 and later).
- **Pairing with non-Configurator hosts:** Allow admin to control to which devices a user device can pair. Disabling this setting prevents pairing except with the supervising host running the Apple Configurator. If no supervising host certificate is configured, all pairing is disabled (iOS 7.0 and later).
- **Predictive keyboards:** Allow user devices to use the predictive keyboard for suggesting words as they type (iOS 8.1.3 and later). Disable this option in situations such as administering standardized tests where you do not want users to have access to suggested words.
- **Keyboard auto-corrections:** Allow user devices to use keyboard autocorrect (iOS 8.1.3 and later). Disable this option in situations such as administering standardized tests where you do not want users to have access to autocorrect.
- **Keyboard spell-check:** Allow user devices to use spell checking while typing (iOS 8.1.3 and later). Disable this option in situations such as administering standardized tests where you do not want users to have access to the spell-checker.
- **Definition lookup:** Allow user devices to use definition look-up while typing (iOS 8.1.3 and later). Disable this option in situations such as administering standardized tests where you do not want users to be able to look up definitions as they type.
- **Single App bundle ID:** Create a list of apps that are allowed to retain control over the device and prevent interaction with other apps or functions.

To add one or more apps, click **Add** and do the following:

- a. **App name:** Enter an app name.
- b. Click **Save** or **Cancel**.
- c. Repeat steps a and b for each app you want to add.

Tip: To delete an existing app, hover over the line containing the app name and then click the trashcan icon on the right-hand side. A confirmation dialog box appears. Click **Delete** to delete the listing or **Cancel** to keep the listing.

To edit an existing app, hover over the line containing the app name and then click the pen icon on the right-hand side.

- **News:** Allow users to use the News app (iOS 9.0 and later).
- **Apple Music service:** Allow users to use the Apple Music service (iOS 9.3 and later). If you don't allow Apple Music service, the

Music app runs in classic mode.

- **iTunes Radio**: Allow users to use iTunes Radio (iOS 9.3 and later).
- **Notifications modification**: Allow users to modify notification settings (iOS 9.3 and later).
- **Restricted App usage**: Allow users to use all apps or to use or not use apps, based on the bundle IDs you provide (iOS 9.3 and later). Applies only to supervised devices.

After you configure the Restrictions device policy to block some apps and then deploy the policy: If you later want to allow some or all of those apps, changing and deploying the Restrictions device policy doesn't change the restrictions. In this case, iOS doesn't apply the changes to the iOS profile. To proceed, use the Profile Removal policy to remove the iOS Profile and then deploy the updated Restrictions device policy.

- **Diagnostic submission modification**: Allow users to modify the diagnostic submission and app analytics settings in the Diagnostics & Usage pane in Settings (iOS 9.3.2 and later).
- **Bluetooth modification**: Allow users to modify Bluetooth settings (iOS 10.0 and later).
- **Security - Show in lock screen**
 - **Control Center**: Allow access to Control Center on the lock screen, which lets users easily modify Airplane Mode, WiFi, Bluetooth, Do Not Disturb Mode, and Lock Rotation settings (iOS 7.0 and later).
 - **Notification**: Allow notifications on the lock screen (iOS 7.0 and later).
 - **Today view**: Allow Today View, which aggregates information such as the weather and the current day's calendar items, on the lock screen.
- **Media content - Allow**
 - **Explicit music, podcasts, and iTunes U material**: Allow explicit material on users' devices.
 - **Explicit sexual content in iBooks**: Allow explicit material to be downloaded from iBooks (iOS 6.0 and later).
 - **Ratings region**: Set the region from which parental control ratings are obtained. In the list, click a country to set the ratings region. The default is **United States**.
 - **Movies**: Set whether movies are allowed on users' devices. If movies are allowed, optionally set the ratings level for movies. In the list, click an option to allow or restrict movies on the device. The default is Allow all movies.
 - **TV Shows**: Set whether TV shows are allowed on users' devices. If TV shows are allowed, optionally set the ratings level for TV shows. In the list, click an option to allow or restrict TV shows on the device. The default is Allow all TV Shows.
 - **Apps**: Set whether apps are allowed on users' devices. If apps are allowed, optionally set the ratings level for apps. In the list, click an option to allow or restrict apps on the device. The default is Allow all apps.
- **Policy Settings**
 - Next to **Remove policy**, click either **Select date** or **Duration until removal (in hours)**.
 - If you click **Select date**, click the calendar to select the specific date for removal.
 - In the **Allow user to remove policy** list, click **Always**, **Password required**, or **Never**.
 - If you click **Password required**, next to **Removal password**, type the necessary password.

XenMobile Analyze Manage **Configure** ⚙️ 🔍 admin ▾

Device Policies Apps Actions ShareFile Delivery Groups

Restrictions Policy

- 1 Policy Info
- 2 Platforms
 - iOS
 - Mac OS X
 - Samsung SAFE
 - Samsung KNOX
 - Windows Phone
 - Windows Tablet
 - Amazon
 - Windows Mobile/CE
- 3 Assignment

Policy Information

This policy allows or restricts users from using certain features on their devices, such as the camera. You can also set security restrictions, as well as restrictions on media content and on certain types of apps users can and cannot install.

Preferences

- Restrict items in System Preferences OFF

Apps

- Allow use of Game Center ON OS X 10.11+
- Allow adding Game Center friends ON
- Allow multiplayer gaming ON
- Allow Game Center account modification ON
- Allow App Store adoption ON
- Allow Safari AutoFill ON
- Require admin password to install or update apps OFF

Back Next >

- **Preferences**

- **Restrict items in System Preferences:** Allow or restrict user access to System Preferences. The default is **OFF**, which allows users full access to System Preferences. If enabled, configure the following settings.
 - **System Preference Pane:** Select whether the settings you select are enabled or disabled. The default is to enable all settings, which are **ON** by default
 - Users & Groups
 - General
 - Accessibility
 - App Store
 - Software Update
 - Bluetooth
 - CDs & DVDs
 - Date & Time
 - Desktop & Screen Saver
 - Displays
 - Dock
 - Energy Saver
 - Extensions
 - FibreChannel
 - iCloud
 - Ink
 - InternetAccounts
 - Keyboard

- Language & Text
- Mission Control
- Mouse
- Network
- Notifications
- Parental Controls
- Printers & Scanners
- Profiles
- Security & Privacy
- Sharing
- Sound
- Diction & Speech
- Spotlight
- Startup Disk
- Time Machine
- Trackpad
- Xsan
- **Apps**
 - **Allow use of Game Center:** Allow users to play online games through Game Center. The default is **ON**.
 - **Allow adding Game Center friends:** Allow users to send a notification to a friend to play a game. The default is **ON**.
 - **Allow multiplayer gaming:** Allow users to initiate multiplayer game play. The default is **ON**.
 - **Allow Game Center account modification:** Allow users to modify their Game Center account settings. The default is **ON**.
 - **Allow App Store adoption:** Allow or restrict apps that preexist in OS X to be adopted by the App Store. The default is **ON**.
 - **Allow Safari Autofill:** Allow Safari to automatically populate fields on websites with passwords, addresses, and other basic information that it has stored. The default is **ON**.
 - **Require admin password to install or update apps:** Require an administrator password to install or update apps. The default is **OFF**, which means no administrator password is required.
 - **Restrict App Store to software update only:** Restrict the App Store to updates only, which disables all tabs in the App Store except Updates. The default is **OFF**, which allows full App Store access.
 - **Restrict which apps are allowed to open:** Restrict or allow apps users can use. The default is **OFF**, which allows all apps to be used. If enabled, configure the following settings:
 - **Allowed Apps:** Click **Add**, enter the name and bundle ID for an app allowed to launch, and then click **Save**. Repeat this step for each app allowed to launch.
 - **Disallowed Folders:** Click **Add**, type the file path to a folder to which you want to restrict user access (for example, /Applications/Utilities), and then click **Save**. Repeat this step for all folders you do not want users to be able to access.
 - **Allowed folders:** Click **Add**, type the file path to a folder to which you want to grant user access, and then click **Save**. Repeat this step for all folders you want users to be able to access.
- **Widgets**
 - **Allow only the following Dashboard widgets to run:** Allow or restrict which Dashboard widgets, such as World Clock or Calculator, users are allowed to run. The default is **OFF**, which allows users to run all widgets. If enabled, configure the following setting:
 - **Allowed Widgets:** Click **Add**, type the name and ID of a widget that is allowed to run, and then click **Save**. Repeat this step for each widget you want to run on the Dashboard.
- **Media**
 - **Allow AirDrop:** Allow users to share photos, videos, web sites, locations, and more with nearby iOS devices.
- **Sharing**
 - **Automatically enable new sharing services:** Select whether to automatically enable sharing services.
 - **Mail:** Select whether to allow a shared mailbox.
 - **Facebook:** Select whether to allow a shared Facebook account.
 - **Video Services - Flickr, Vimeo, Tudou and Youku:** Select whether to allow shared video services.
 - **Add to Aperture:** Select whether to allow shared ability to add to Aperture.
 - **Sina Weibo:** Select whether to allow a shared Sina Weibo microblogging account.
 - **Twitter:** Select whether to allow a shared Twitter account.

- **Messages:** Select whether to allow shared access to messages.
- **Add to iPhoto:** Select whether to allow shared ability to add to iPhoto.
- **Add to Reading List:** Select whether to allow shared ability to add to Reading List.
- **AirDrop:** Select whether to allow a shared AirDrop account.
- **Functionality**
 - **Lock desktop picture:** Select whether users can change the desktop picture. The default is **OFF**, which means users can change the desktop picture.
 - **Allow use of camera:** Select whether users can use the camera on their Macs. The default is **OFF**, which means users cannot use the camera.
 - **Allow Apple Music:** Allow users to use the Apple Music service (macOS 10.12 and later). If you don't allow Apple Music service, the Music app runs in classic mode. Applies only to supervised devices. Defaults to **ON**.
 - **Allow Spotlight Suggestions:** Select whether users can use Spotlight Suggestions to search their Mac and to provide Spotlight Suggestions from the Internet, iTunes, and the App Store. The default is **OFF**, which prevents users from using Spotlight Suggestions. For more information about Spotlight Suggestions, see Apple's [Spotlight Suggestions](#) page.
 - **Allow Look Up:** Select whether users can look up the definitions of words with the context menu or the Spotlight search menu. The default is **OFF**, which prevents users from using Look Up on their Macs.
 - **Allow use of iCloud password for local accounts:** Select whether users can use their Apple ID and iCloud password to sign on to their Macs. Enabling this means that user will use only one ID and password for *a//*login screens on their Macs. The default is **ON**, which allows users to use their Apple ID and iCloud password to access their Macs.
 - **Allow iCloud documents & data:** Select whether to allow users to access documents and data stored on iCloud on their Macs. The default is **OFF**, which prevents users from using iCloud documents and data on their Macs. For more information, see Apple's [iCloud documents and Data](#) page.
 - **Allow iCloud Desktop and Documents:** (macOS 10.12.4 and later) The default is selected.
 - **Allow iCloud Keychain Sync:** Allow iCloud Keychain sync (macOS 10.12 and later). The default is **ON**.
 - **Allow iCloud Mail:** Allow users to use iCloud Mail (macOS 10.12 and later). The default is **ON**.
 - **Allow iCloud Contacts:** Allow users to use iCloud Contacts (macOS 10.12 and later). The default is **ON**.
 - **Allow iCloud Calendars:** Allow users to use iCloud Calendars (macOS 10.12 and later). The default is **ON**.
 - **Allow iCloud Reminders:** Allow users to use iCloud Reminders (macOS 10.12 and later). The default is **ON**.
 - **Allow iCloud Bookmarks:** Allow users to sync with iCloud Bookmarks (macOS 10.12 and later). The default is **ON**.
 - **Allow iCloud Notes:** Allow users to use Cloud Notes (macOS 10.12 and later). The default is **ON**.
 - **Allow iCloud Photos:** If you change this setting to **Off**, any photos not fully downloaded from the iCloud Photo Library are removed from local device storage (macOS 10.12 and later). The default is **ON**.
 - **Allow Auto Unlock:** For information about this option and Apple Watch, see <http://www.imore.com/auto-unlock> (macOS 10.12 and later). The default is **ON**.
 - **Allow Touch ID To Unlock Mac:** (macOS 10.12.4 and later). The default is **ON**.
- **Policy Setting**
 - Next to **Remove policy**, click either **Select date** or **Duration until removal (in hours)**
 - If you click **Select date**, click the calendar to select the specific date for removal
 - In the **Allow user to remove policy** list, click **Always**, **Password required**, or **Never**
 - If you click **Password required**, next to **Removal password**, type the necessary password.
 - In the **Profile Scope** list, click **User** or **System** (OS X 10.7 and later).

Note: Some options are available only under specific Samsung Mobile Device Management APIs; they are marked with the relevant version information.

- **Allow hardware controls**
 - **Enable ODE Trusted Boot Verification:** Use ODE trusted boot verification to establish a chain of trust from the bootloader to the system image.
 - **Allow Development Mode:** Allow users to enable the developer settings on their devices.
 - **Allow Emergency Call Only:** Allow users to enable Emergency Call Only mode on their devices.
 - **Allow Firmware Recovery:** Allow users to recover the firmware on their devices.
 - **Allow Fast Encryption:** Allow encryption of only used memory space. This is in contrast to full disk encryption, which encrypts all data, including settings, application data, downloaded files and applications, media, and other files.
 - **Common Criteria Mode:** Place device into Common Criteria Mode. The Common Criteria configuration enforces stringent security processes.
 - **Factory Reset:** Allow users to do a factory reset on their devices.
 - **Date Time Change:** Allow users to change the date and time on their devices.
 - **DOD reboot banner:** Display a DoD approved system use notification message or banner when users' devices are restarted.
 - **Settings changes:** Allow users to change settings on their devices.
 - **Backup:** Allow users to back up application and system data on their devices.
 - **Over The Air Upgrade:** Allow users' devices to receive software updates wirelessly (MDM 3.0 and later).
 - **Background data:** Allow apps to sync data in the background.
 - **Camera:** Allow users to use the camera on their devices.
 - **Clipboard:** Allow users to copy data to the clipboard on their devices.
 - **Clipboard share:** Allow users to share clipboard content between their devices and a computer (MDM 4.0 and later).
 - **Home key:** Allow users to use the Home key on their devices.

- **Microphone:** Allow users to use the microphone on their devices.
- **Mock location:** Allow users to fake their GPS location.
- **NFC:** Allow users to use NFC (Near Field Communication) on their devices (MDM 3.0 and later).
- **Power off:** Allow users to turn off their devices (MDM 3.0 and later).
- **Screenshot:** Allow users to take screen shots on their devices.
- **SD card:** Allow users to use an SD card, if available, with their devices.
- **Voice Dialer:** Allow users to use the voice dialer on their devices (MDM 4.0 and later).
- **SBeam:** Allow users to share content with others using NFC and Wi-Fi Direct (MDM 4.0 and later).
- **SVoice:** Allow users to use the intelligent personal assistant and knowledge navigator on their devices (MDM 4.0 and later).
- **Allow apps**
 - **Browser:** Allow users to use the web browser.
 - **Youtube:** Allow users to access YouTube.
 - **Google Play/Marketplace:** Allow users to access Google Play and the Google Apps Marketplace.
 - **Allow Non-Google Play apps:** Allow users to download apps from sites other than Google Play and the Google Apps Marketplace.
 - **Stop system app:** Allow users to disable pre-installed system apps (MDM 4.0 and later).
- **Network**
 - **Incoming Mms:** Allow users to receive MMS messages.
 - **Incoming Sms:** Allow users to receive SMS messages.
 - **Outgoing Mms:** Allow users to send MMS messages.
 - **Outgoing Sms:** Allow users send SMS messages.
 - **User Add profiles Vpn:**
 - **Bluetooth:** Allow users to use Bluetooth.
 - **Tethering:** Allow users to share a mobile data connection with another device using their Bluetooth connection.
 - **WiFi:** Allow users to connect to WiFi networks.
 - **Tethering:** Allow users to share a mobile data connection with another device using their WiFi connection.
 - **Direct:** Allow users to connect directly to another device through their WiFi connection (MDM 4.0 and later).
 - **State Change:** Allow apps to change WiFi connectivity state.
 - **User Policy Changes:** Allow users to change WiFi policies. If not selected, users can change only the WiFi user name and password. If selected, users can change all WiFi policies.
 - **Tethering:** Allow users to share a mobile data connection with another device.
 - **Cellular data:** Allow users to use their cellular connection for data.
 - **Allow roaming:** Allow users to use cellular data while roaming. The default is OFF, which disables roaming on users' devices.
 - **Only secure connections:** Allow users to only use secure connections (MDM 4.0 and later).
 - **Android beam:** Allow users to send web pages, photos, videos, or other content from their devices to another device using NFC (MDM 4.0 and later).
 - **Audio record:** Allow users to record audio with their devices (MDM 4.0 and later).
 - **Video record:** Allow users to record video with their devices (MDM 4.0 and later).
 - **Location services:** Allow users to turn on GPS on their devices.
 - **Limit by day (MB):** Enter the number of MB of mobile data users can use each day. The default is 0, which disables this feature (MDM 4.0 and later).
 - **Limit by week (MB):** Enter the number of MB of mobile data users can use each week. The default is 0, which disables this feature (MDM 4.0 and later).
 - **Limit by month (MB):** Enter the number of MB of mobile data users can use each month. The default is 0, which disables this feature (MDM 4.0 and later).
- **Allow USB actions** Allow USB connection between users' devices and a computer.
 - **Debugging:** Allow debugging over USB.
 - **Host storage:** Allow users' devices to act as the USB host when a USB device connects to their devices. Users' devices then supply power to the USB device.
 - **Mass storage:** Allow transfer of large data files between users' devices and a computer over a USB connection.
 - **Kies media player:** Allow users to use the Samsung Kies tool to sync files between their devices and a computer.
 - **Tethering:** Allow users to share a mobile data connection with another device through a USB connection.

XenMobile Analyze Manage Configure admin

Device Policies Apps Actions ShareFile Enrollment Profiles Delivery Groups

Restrictions Policy

This policy allows or restricts users from using certain features on their devices, such as the camera. You can also set security restrictions, as well as restrictions on media content and on certain types of apps users can and cannot install.

- 1 Policy Info
- 2 Platforms
 - iOS
 - Mac OS X
 - Samsung SAFE
 - Samsung KNOX
 - Windows Phone
 - Windows Desktop/Tablet
 - Amazon
 - Windows Mobile/CE
- 3 Assignment

Allow use of camera **ON**

Enable Revocation Check **ON**

Move Apps To Container **ON**

Enforce Multifactor Authentication **ON**

Enable TIMA Key store **ON**

Enforce Auth For Container **ON**

Share List **ON**

Enable Audit Log **ON**

Use Secure Keypad **ON**

Enable Google Apps **ON**

Authentication Smart Card Browser **ON**

► Deployment Rules

Back Next >

Note: These options are available only under Samsung KNOX Premium (KNOX 2.0).

- **Allow Use of Camera:** Allow users to use the camera on their devices.
- **Allow Revocation Check:** Enable checking for revoked certificates.
- **Move Apps To Container:** Allow users to move apps between the KNOX container and the personal area on their devices.
- **Enforce Multifactor Authentication:** Users must use a fingerprint and one other authentication method, such as password or PIN, to open their devices.
- **Enable TIMA Key store:** The TIMA KeyStore provides TrustZone-based secure key storage for the symmetric keys. RSA key pairs and certificates are routed to the default key store provider for storage.
- **Enforce Auth For Container:** Use separate, and different, authentication to open the KNOX container from that used to unlock the device.
- **Share List:** Allow users to share content between apps in the Share Via list
- **Enable Audit Log:** Enable creation of event audit logs for forensic analysis of a device.
- **Use Secure Keypad:** Force users to use a secure keyboard inside the KNOX container.
- **Enable Google Apps:** Allow users to download apps from Google Mobile Services into the KNOX container.
- **Authentication Smart Card Browser:** Enable browser authentication on devices equipped with a smart card reader.

XenMobile Analyze Manage **Configure** ⚙️ 🔍 admin ▾

Device Policies Apps Actions ShareFile Delivery Groups

Restrictions Policy

- Policy Info
- Platforms
 - iOS
 - Mac OS X
 - Samsung SAFE
 - Samsung KNOX
 - Windows Phone
 - Windows Tablet
 - Amazon
 - Windows Mobile/CE
- Assignment

Policy Information

This policy allows or restricts users from using certain features on their devices, such as the camera. You can also set security restrictions, as well as restrictions on media content and on certain types of apps users can and cannot install.

WiFi Settings

- Allow WiFi
- Allow Internet sharing
- Allow auto-connect to WiFi Sense hotspots
- Allow hotspot reporting
- Allow manual configuration

Connectivity

- Allow NFC
- Allow bluetooth
- Allow VPN over cellular
- Allow VPN over cellular while roaming

Back Next >

- **WiFi Settings**
 - **Allow WiFi:** Allow a device to connect to a WiFi network.
 - **Allow Internet sharing:** Allow a device to share its internet connection with other devices by turning it into a WiFi hotspot.
 - **Allow auto-connect to WiFi Sense hotspots:** Allow a device to connect automatically to WiFi Sense hotspots. Location services must be enabled for this option to work. For more information about WiFi Sense, see the Windows Phone [WiFi Sense FAQ](#).
 - **Allow manual configuration:** Allow users to manually configure WiFi connections.
- **Connectivity**
 - **Allow NFC:** Allow device to communicate with an NFC (Near Field Communication) tag or another NFC-enabled transmitting device.
 - **Allow bluetooth:** Allow device to connect through Bluetooth.
 - **Allow VPN over cellular:** Allow the device to connect over VPN to a cellular network.
 - **Allow VPN over cellular while roaming:** Allow the device to connect over VPN when the device roams over cellular networks.
 - **Allow USB connection:** Allow a desktop to access a device's storage through a USB connection.
 - **Allow cellular data roaming:** Allow users to use cellular data while roaming.
- **Accounts**
 - **Allow Microsoft account connection:** Allow the device to use a Microsoft account for non-email related connection authentication and services.
 - **Allow non-Microsoft email:** Allow user to add non-Microsoft email accounts.
- **Search**
 - **Allow search to use location:** Allow searches to use the device's location service.

- **Filter adult content:** Allow adult content. The default is **OFF**, which means adult content is not filtered.
- **Allow Bing Vision to store images:** Allow Bing Vision to store images captured when performing Bing Vision searches.
- **System**
 - **Allow storage card:** Allow the device to use a storage card.
 - **Allow location services:** Allow location services.
 - **Allow use of camera:** Allow users to use their device's camera.
 - **Telemetry:** In the list, click an option to allow or restrict the device from sending telemetry information. The default is **Allowed**. Other options are **Not allowed** and **Allowed, except for secondary data request**.
- **Security**
 - **Allow manual root certificate installation:** Allow users to manually install a root certificate.
 - **Require device encryption:** Require device encryption. Note that after encryption is enabled on a device, it cannot be disabled. The default is **OFF**.
 - **Allow copy and paste:** Allow users to copy and paste data on their devices.
 - **Allow screen capture:** Allow users to create screen captures on their devices.
 - **Allow voice recording:** Allow users to use voice recording on their devices.
 - **Allow Save As of Office files:** Allow users to save Office files with Save As.
 - **Allow action center notifications:** Allow Action Center notifications on the device's lock screen.
 - **Allow Cortana:** Allow users access to Cortana, the intelligent personal assistant and knowledge navigator.
 - **Allow sync of device settings:** Allow users to sync settings between Windows Phone 8.1 devices when roaming.
- **Apps**
 - **Allow store access:** Allow users to access the Microsoft Store.
 - **Allow developer unlock:** Allow users to register their devices with Microsoft and develop or install apps that are not in the Windows Phone app store.
 - **Allow web browser access:** Allow Internet Explorer on the device.

Restrictions Policy

1 Policy Info

2 Platforms

- iOS
- Mac OS X
- Samsung SAFE
- Samsung KNOX
- Windows Phone
- Windows Tablet
- Amazon
- Windows Mobile/CE

3 Assignment

Policy Information

This policy allows or restricts users from using certain features on their devices, such as the camera. You can also set security restrictions, as well as restrictions on media content and on certain types of apps users can and cannot install.

Network

Roaming data OFF

Security

User account control

Enable Windows error reporting OFF

Enable smart screen OFF

Other

Enterprise client sync product's URL enable OFF

Enterprise client sync product's URL

Deployment Rules

Back Next >

Note: The default for the following settings is **OFF**.

- **Network**
 - **Roaming data:** Allow users to use cellular data while roaming.
- **Security**
 - **User account control:** Set the level of notification users receive when apps try to make changes to devices. In the list, click an option to set what kind of notification users receive. The default is **Always notify**, which means any change dims the device's screen and triggers a notice that requires users to respond before they can continue. Other options are **Notify app changes**, **Notify app changes (no dim)**, and **Never notify**.
 - **Enable Windows error reporting:** Allows Windows Error Reporting to report device problems to Microsoft.
 - **Enable smart screen:** Enable Windows SmartScreen to check downloaded files and web content within apps for malicious software and potentially unsafe web content.
- **Other**
 - **Enterprise client sync product's URL enable:** Enable enterprise client sync on the device.
 - **Enterprise client sync product's URL:** When Enterprise client sync product's URL enabled is **ON**, type a valid URL address.

XenMobile Analyze Manage **Configure** ⚙️ 🔍 admin ▾

Device Policies Apps Actions ShareFile Delivery Groups

Restrictions Policy

- 1 Policy Info
- 2 Platforms
 - iOS
 - Mac OS X
 - Samsung SAFE
 - Samsung KNOX
 - Windows Phone
 - Windows Tablet
 - Amazon
 - Windows Mobile/CE
- 3 Assignment

Policy Information

This policy allows or restricts users from using certain features on their devices, such as the camera. You can also set security restrictions, as well as restrictions on media content and on certain types of apps users can and cannot install.

Allow hardware controls

- Factory reset
- Profiles

Allow apps

- Non-Amazon Appstore apps
- Social networks

Network

- Bluetooth
- WiFi switch
- WiFi settings
- Cellular data

Back Next >

- **Allow hardware controls**
 - **Factory reset:** Allow users to do a factory reset on their devices
 - **Profiles:** Allow users to change the hardware profile on their devices.
- **Allow apps**
 - **Non-Amazon Appstore apps:** Allow users to install non-Amazon Appstore apps on their devices.
 - **Social networks:** Allow users to access social networks from their devices.
- **Network**
 - **Bluetooth:** Allow users to use Bluetooth.
 - **WiFi switch:** Allow apps to change WiFi connectivity state.
 - **WiFi settings:** Allow users to change WiFi settings.
 - **Cellular data:** Allow users to use their cellular connection for data.
 - **Roaming data:** Allow users to use cellular data while roaming.
 - **Location services:** Allow users to use GPS.
- **USB actions:**
 - **Debugging:** Allow users' devices to connect through USB to a computer for debugging.

XenMobile Analyze Manage **Configure** ⚙️ 🔍 admin ▾

Device Policies Apps Actions ShareFile Delivery Groups

Restrictions Policy

- 1 Policy Info
- 2 Platforms
 - iOS
 - Mac OS X
 - Samsung SAFE
 - Samsung KNOX
 - Windows Phone
 - Windows Tablet
 - Amazon
 - Windows Mobile/CE
- 3 Assignment

Policy Information

This policy allows or restricts users from using certain features on their devices, such as the camera. You can also set security restrictions, as well as restrictions on media content and on certain types of apps users can and cannot install.

- Bluetooth/infrared beaming (Obex)
- Camera
- WiFi switch
- Bluetooth

Deployment Rules

Back Next >

- **Bluetooth/infrared beaming (Obex):** Enable OBEX (OBject EXchange protocol) over Bluetooth or infrared to exchange data between devices.
- **Camera:** Enable the camera on users' devices.
- **WiFi switch:** Allow users to switch WiFi networks.
- **Bluetooth:** Enable Bluetooth on users' devices.

7. Configure deployment rules and choose delivery groups. For more information, see [Add a device policy](#).

Roaming device policy

Jun 19, 2017

You can add a device policy in XenMobile to configure whether to allow voice and data roaming on users' iOS and Windows Mobile/CE devices. When voice roaming is disabled, data roaming is automatically disabled. For iOS, this policy is available only on iOS 5.0 and later devices.

1. In the XenMobile console, click **Configure** > **Device Policies**. The **Device Policies** page appears.
 2. Click **Add**. The **Add a New Policy** dialog box appears.
 3. Click **More** and then, under **Network access**, click **Roaming**. The **Roaming Policy** information page appears.
 4. In the **Policy Information** pane, enter the following information:
 - **Policy Name:** Type a descriptive name for the policy.
 - **Description:** Optionally, type a description of the policy.
 5. Click **Next**. The **Platforms** page appears.
 6. Under **Platforms**, select the platforms you want to add. If you are only configuring for one platform, clear the others.
- When you finish configuring the settings for a platform, refer to Step 7 for how to set that platform's deployment rules.

The screenshot shows the XenMobile console interface for configuring a Roaming Policy. The top navigation bar is green and contains 'XenMobile', 'Analyze', 'Manage', 'Configure', and 'admin'. Below the navigation bar, there are tabs for 'Device Policies', 'Apps', 'Actions', 'ShareFile', and 'Delivery Groups'. The main content area is titled 'Roaming Policy' and has a 'Policy Information' section. The 'Policy Information' section contains two toggle switches: 'Disable voice roaming' (set to OFF) and 'Disable data roaming' (set to OFF). Below these is a 'Deployment Rules' section. The left sidebar shows a list of steps: '1 Policy Info', '2 Platforms', and '3 Assignment'. The 'Platforms' section is currently active, showing 'iOS' and 'Windows Mobile/CE' selected with checkmarks. The bottom right corner has 'Back' and 'Next >' buttons.

Configure these settings:

- **Disable voice roaming:** Select whether to disable voice roaming. When this option is enabled, data roaming is automatically disabled. The default is **OFF**, which allows voice roaming.
- **Disable data roaming:** Select whether to disable data roaming. This option is available only when voice roaming is enabled. The default is **OFF**, which allows data roaming.

The screenshot shows the XenMobile configuration interface for a Roaming Policy. The top navigation bar includes 'XenMobile', 'Analyze', 'Manage', and 'Configure'. Below this, there are tabs for 'Device Policies', 'Apps', 'Actions', 'ShareFile', and 'Delivery Groups'. The left sidebar shows the 'Roaming Policy' section with sub-items: '1 Policy Info', '2 Platforms' (with 'iOS' and 'Windows Mobile/CE' checked), and '3 Assignment'. The main content area is titled 'Policy Information' and contains a description: 'This policy lets you limit the device from using voice and data roaming. For iOS, the policy applies to iOS 5 and later devices.' Below this, there are five settings under the 'While roaming' section, each with a toggle switch set to 'OFF':

- Use on-demand connection only
- Block all cellular connections except the ones managed by XenMobile
- Block all cellular connections managed by XenMobile
- Block all cellular connections to XenMobile
- Ignore domestic roaming

 At the bottom of the main area, there is a 'Deployment Rules' section with a right-pointing arrow, and 'Back' and 'Next >' buttons.

Configure these settings:

- **While roaming**
 - **Use on-demand connection only:** The device only connects to XenMobile if users manually trigger the connection on their devices, or if a mobile application requests a forced connection (such as a push mail request if the Exchange Server has been set accordingly). Note that this option temporarily disables the default device connection schedule policy.
 - **Block all cellular connections except the ones managed by XenMobile:** Except for the data traffic officially declared in a XenMobile application tunnel or other XenMobile device management task, no other data is sent or received by the device. For example, this option disables all connections to the Internet through the device's web browser.
 - **Block all cellular connections managed by XenMobile:** All application data transiting through a XenMobile tunnel is blocked (including XenMobile Remote Support). The data traffic related to pure device management, however, is not blocked.
 - **Block all cellular connections to XenMobile:** In this case, until the device is either reconnected through USB, WiFi, or its default mobile operator cellular network, there is no traffic transiting between the device and XenMobile.
- **While domestic roaming**
 - **Ignore domestic roaming:** No data is blocked while users roam domestically.

7. Configure deployment rules and choose delivery groups. For more information, see [Add a device policy](#).

Samsung MDM license key device policy

Jun 19, 2017

XenMobile supports and extends both Samsung for Enterprise (SAFE) and Samsung KNOX policies. SAFE is a family of solutions that provides security and feature enhancements for business use through integration with mobile device management solutions. Samsung KNOX is a solution within the SAFE program that provides a more secure Android platform for enterprise use.

You must enable the SAFE APIs by deploying the built-in Samsung Enterprise License Management (ELM) key to a device before you can deploy SAFE policies and restrictions. To enable the Samsung KNOX API, you also need to purchase a Samsung KNOX Workspace license using the Samsung KNOX License Management System (KLMS), in addition to deploying the Samsung ELM key. The Samsung KLMS provisions valid licenses to mobile device management solutions to enable them to activate Samsung KNOX APIs on mobile devices. These licenses must be obtained from Samsung and are not provided by Citrix.

You must deploy Secure Hub along with the Samsung ELM key to enable the SAFE and Samsung KNOX APIs. You can verify that the SAFE APIs are enabled by checking the device properties. When the Samsung ELM key is deployed, the **Samsung MDM API available** setting is set to **True**.

1. In the XenMobile console, click **Configure > Device Policies**. The **Device Policies** page appears.
 2. Click **Add**. The **Add a New Policy** dialog appears.
 3. Click **More** and then, under **Security**, click **Samsung MDM License Key**. The **Samsung MDM License Key Policy** information page appears.
 4. In the **Policy Information** pane, enter the following information:
 - **Policy Name**: Type a descriptive name for the policy.
 - **Description**: Type an optional description of the policy.
 5. Click **Next**. The **Platforms** page appears.
 6. Under **Platforms**, select the platforms you want to add. If you are only configuring for one platform, clear the others.
- When you finish configuring the settings for a platform, refer to Step 7 for how to set that platform's deployment rules.

The screenshot shows the XenMobile configuration interface for a Samsung MDM License Key Policy. The top navigation bar includes 'XenMobile', 'Analyze', 'Manage', and 'Configure'. Below this, there are tabs for 'Device Policies', 'Apps', 'Actions', 'ShareFile', and 'Delivery Groups'. The main content area is titled 'Policy Information' and includes a description: 'This policy lets you generate a Samsung ELM license key.' A form field labeled 'ELM license key*' contains the text '\${elm.license.key}'. Below this is a section for 'Deployment Rules'. On the left, a sidebar shows the policy configuration steps: '1 Policy Info', '2 Platforms', and '3 Assignment'. Under '2 Platforms', 'Samsung SAFE' and 'Samsung KNOX' are both checked. At the bottom right, there are 'Back' and 'Next >' buttons.

Configure this setting:

- **ELM License key:** This field should already contain the macro that generates the ELM license key. If the field is blank, type the macro `${elm.license.key}`.

This screenshot is similar to the previous one, showing the configuration page for the Samsung MDM License Key Policy. However, the 'KNOX license key*' field is currently empty. A help icon (question mark) is visible to the right of the input field. The 'Deployment Rules' section and the sidebar configuration remain the same as in the previous screenshot.

Configure this setting:

- **KNOX License key:** Type the KNOX license key that you obtained from Samsung.

7. Configure deployment rules and choose delivery groups. For more information, see [Add a device policy](#).

Samsung SAFE firewall device policy

Jun 19, 2017

This policy lets you configure the firewall settings for Samsung devices. You enter IP addresses, ports, and host names that you want to allow devices to access or that you want to block devices from accessing. You can also configure proxy and proxy reroute settings.

1. In the XenMobile console, click **Configure** > **Device Policies**. The **Device Policies** page appears.
2. Click **Add**. The **Add a New Policy** dialog box appears.
3. Expand **More** and then, under **Network access**, click **Samsung Firewall**. The **Samsung Firewall Policy** page appears.
4. In the **Policy Information** pane, enter the following information:
 - **Policy Name:** Type a descriptive name for the policy.
 - **Description:** Optionally, type a description of the policy.
5. Click **Next**. The **Samsung SAFE** platform information page appears.

The screenshot shows the XenMobile console interface. The top navigation bar includes 'XenMobile', 'Analyze', 'Manage', and 'Configure'. Below this, there are tabs for 'Device Policies', 'Apps', 'Actions', 'ShareFile', and 'Delivery Groups'. The main content area is titled 'Samsung Firewall Policy' and is divided into a sidebar and a main pane. The sidebar contains a list of items: '1 Policy Info', '2 Platforms', '3 Assignment', and 'Samsung SAFE' (which is selected). The main pane is titled 'Policy Information' and contains a description of the policy. Below the description are three sections: 'Allow/Deny hosts', 'Reroute configuration', and 'Proxy Configuration'. The 'Allow/Deny hosts' section has a table with columns for 'Host name/IP range*', 'Port/port range*', and 'Allow/deny rule filter', and an 'Add' button. The 'Reroute configuration' section has a table with columns for 'Host name/IP address/IP range*', 'Port/port range*', 'Proxy IP*', and 'Proxy Port*', and an 'Add' button. The 'Proxy Configuration' section has input fields for 'Proxy IP' and 'Port'. At the bottom right, there are 'Back' and 'Next >' buttons.

6. Configure these settings:

- **Allow/Deny hosts**
 - For each host to which you want to allow or deny access, click **Add** and do the following:
 - **Host name/IP range:** Type the host name or IP address range of the site you want to affect.
 - **Port/port range:** Type the port or port range.
 - **Allow/deny rule filter:** Select **Whitelist** to allow access or click **Blacklist** to deny access to the site.

- Click **Save** or **Cancel**.
- **Reroute configuration**
 - For each proxy you want to configure, click **Add** and do the following:
 - **Host name/IP range**: Type the host name or IP address range for the proxy reroute.
 - **Port/port range**: Type the port or port range.
 - **Proxy IP**: Type the proxy IP address.
 - **Proxy port**: Type the proxy port.
 - Click **Save** or **Cancel**.

Note: To delete an existing item, hover over the line containing the listing and then click the trash can icon on the right-hand side. A confirmation dialog box appears. Click **Delete** to delete the listing or **Cancel** to keep the listing.

To edit an existing item, hover over the line containing the listing and then click the pen icon on the right-hand side. Make any changes to the listing and then click **Save** to save the changed listing or **Cancel** to leave the listing unchanged.

- **Proxy Configuration**
 - **Proxy IP**: Type the IP address of the proxy server.
 - **Port**: Type the proxy server port.

7. Configure deployment rules and choose delivery groups. For more information, see [Add a device policy](#).

SCEP device policy

Jun 19, 2017

This policy allows you to configure iOS and Mac OS X devices to retrieve a certificate using Simple Certificate Enrollment Protocol (SCEP) from an external SCEP server. If you want to deliver a certificate to the device using SCEP from a PKI that is connected to XenMobile, you should create a PKI entity and a PKI provider in distributed mode. For details, see [PKI Entities](#).

[iOS settings](#)

[Mac OS X settings](#)

1. In the XenMobile console, click **Configure** > **Device Policies**. The **Device Policies** page appears.
 2. Click **Add**. The **Add New Policy** dialog box appears.
 3. Expand **More** and then, under **Security**, click **SCEP**. The **SCEP Policy** information page appears.
 4. In the **Policy Information** pane, type the following information:
 - **Policy Name**: Type a descriptive name for the policy.
 - **Description**: Type an optional description of the policy.
 5. Click **Next**. The **Platforms** page appears.
 6. Under **Platforms**, select the platforms you want to add. If you are only configuring for one platform, clear the others.
- When you finish configuring the settings for a platform, refer to Step 7 for how to set that platform's deployment rules.

XenMobile Analyze Manage **Configure** ⚙️ 🔍 admin ▾

Device Policies Apps Actions ShareFile Delivery Groups

SCEP Policy

- 1 Policy Info
- 2 Platforms
 - iOS
 - Mac OS X
 - Windows Phone
 - Windows Tablet
- 3 Assignment

Policy Information

This policy lets you create an Simple Certificate Enrollment Protocol (SCEP) profile to enable devices to obtain certificates from a Certificate Authority. For Windows Phone/Tablet, the payloads are supported only on Windows 10 and later supervised devices.

URL base*

Instance name*

Subject X.500 name (RFC 2253)

Subject alternative names type

Maximum retries

Retry delay

Challenge password

Key size (bits)

Use as digital signature

Use for key encipherment

SHA1/MD5 fingerprint (hexadecimal string)

Policy Settings

Remove policy Select date Duration until removal (in days)

Allow user to remove policy

Deployment Rules

Configure these settings:

- **URL base:** Type the address of the SCEP server to define where SCEP requests are sent, over HTTP or HTTPS. The private key isn't sent with the Certificate Signing Request (CSR), so it may be safe to send the request unencrypted. If, however, the one-time password is allowed to be reused, you should use HTTPS to protect the password. This step is required.
- **Instance name:** Type any string that the SCEP server recognizes. For example, it could be a domain name like example.org. If a CA has multiple CA certificates, you can use this field to distinguish the required domain. This step is required.
- **Subject X.500 name (RFC 2253):** Type the representation of a X.500 name represented as an array of Object Identifier (OID) and value. For example, /C=US/O=Apple Inc./CN=foo/1.2.5.3=bar, which would translate to: [["C", "US"]

], [["O", "Apple Inc."], ..., [["1.2.5.3", "bar"]]]. You can represent OIDs as dotted numbers with shortcuts for country (C), locality (L), state (ST), organization (O), organizational unit (OU), and common name (CN).

- **Subject alternative names type:** In the list, click an alternative name type. The SCEP policy can specify an optional alternative name type that provides values required by the CA for issuing a certificate. You can specify **None**, **RFC 822 name**, **DNS name**, or **URI**.
- **Maximum retries:** Type the number of times a device should retry when the SCEP server sends a PENDING response. The default is 3.
- **Retry delay:** Type the number of seconds to wait between subsequent retries. The first retry is attempted without delay. The default is 10.
- **Challenge password:** Enter a pre-shared secret.
- **Key size (bits):** In the list, click the key size in bits, either **1024** or **2048**. The default is **1024**.
- **Use as digital signature:** Specify whether you want the certificate to be used as a digital signature. If someone is using the certificate to verify a digital signature, such as verifying whether a certificate was issued by a CA, the SCEP server would verify that the certificate can be used in this manner prior to using the public key to decrypt the hash.
- **Use for key encipherment:** Specify whether you want the certificate to be used for key encipherment. If a server is using the public key in a certificate provided by a client to verify that a piece of data was encrypted using the private key, the server would first check to see whether the certificate can be used for key encipherment. If not, the operation fails.
- **SHA1/MD5 fingerprint (hexadecimal string):** If your CA uses HTTP, use this field to provide the fingerprint of the CA certificate, which the device uses to confirm authenticity of the CA response during enrollment. You can enter a SHA1 or MD5 fingerprint, or you can select a certificate to import its signature.
- **Policy Settings**
 - Under **Policy Settings**, next to **Remove policy**, click either **Select date** or **Duration until removal (in hours)**.
 - If you click **Select date**, click the calendar to select the specific date for removal.
 - In the **Allow user to remove policy** list, click **Always**, **Password required**, or **Never**.
 - If you click **Password required**, next to **Removal password**, type the necessary password.

XenMobile Analyze Manage **Configure** ⚙️ 🔍 admin ▾

Device Policies Apps Actions ShareFile Delivery Groups

SCEP Policy

- Policy Info
- Platforms
 - iOS
 - Mac OS X
 - Windows Phone
 - Windows Tablet
- Assignment

Policy Information

This policy lets you create an Simple Certificate Enrollment Protocol (SCEP) profile to enable devices to obtain certificates from a Certificate Authority. For Windows Phone/Tablet, the payloads are supported only on Windows 10 and later supervised devices.

URL base*

Instance name*

Subject X.500 name (RFC 2253)

Subject alternative names type

Maximum retries

Retry delay

Challenge password

Key size (bits)

Use as digital signature

Use for key encipherment

SHA1/MD5 fingerprint (hexadecimal string)

Certificate expiration notification threshold

Policy Settings

Remove policy Select date Duration until removal (in days)

Allow user to remove policy

Profile scope OS X 10.7+

► Deployment Rules

Configure these settings:

- **URL base:** Type the address of the SCEP server to define where SCEP requests are sent, over HTTP or HTTPS. The private key isn't sent with the Certificate Signing Request (CSR), so it may be safe to send the request unencrypted. If, however, the one-time password is allowed to be reused, you should use HTTPS to protect the password. This step is required.
- **Instance name:** Type any string that the SCEP server recognizes. For example, it could be a domain name like example.org. If a CA has multiple CA certificates, you can use this field to distinguish the required domain. This step is

required.

- **Subject X.500 name (RFC 2253):** Type the representation of a X.500 name represented as an array of Object Identifier (OID) and value. For example, /C=US/O=Apple Inc./CN=foo/1.2.5.3=bar, which would translate to: [["C", "US"], ["O", "Apple Inc."], ..., [["1.2.5.3", "bar"]]]. You can represent OIDs as dotted numbers with shortcuts for country (C), locality (L), state (ST), organization (O), organizational unit (OU), and common name (CN).
- **Subject alternative names type:** In the list, click an alternative name type. The SCEP policy can specify an optional alternative name type that provides values required by the CA for issuing a certificate. You can specify **None**, **RFC 822 name**, **DNS name**, or **URI**.
- **Maximum retries:** Type the number of times a device should retry when the SCEP server sends a PENDING response. The default is 3.
- **Retry delay:** Type the number of seconds to wait between subsequent retries. The first retry is attempted without delay. The default is 10.
- **Challenge password:** Type a pre-shared secret.
- **Key size (bits):** In the list, click the key size in bits, either 1024 or 2048. The default is 1024.
- **Use as digital signature:** Specify whether you want the certificate to be used as a digital signature. If someone is using the certificate to verify a digital signature, such as verifying whether a certificate was issued by a CA, the SCEP server would verify that the certificate can be used in this manner prior to using the public key to decrypt the hash.
- **Use for key encipherment:** Specify whether you want the certificate to be used for key encipherment. If a server is using the public key in a certificate provided by a client to verify that a piece of data was encrypted using the private key, the server would first check to see whether the certificate can be used for key encipherment. If not, the operation fails.
- **SHA1/MD5 fingerprint (hexadecimal string):** If your CA uses HTTP, use this field to provide the fingerprint of the CA certificate, which the device uses to confirm authenticity of the CA response during enrollment. You can enter a SHA1 or MD5 fingerprint, or you can select a certificate to import its signature.
- **Policy Settings**
 - Under **Policy Settings**, next to **Remove policy**, click either **Select date** or **Duration until removal (in hours)**.
 - If you click **Select date**, click the calendar to select the specific date for removal.
 - In the **Allow user to remove policy** list, click **Always**, **Password required**, or **Never**.
 - If you click **Password required**, next to **Removal password**, type the necessary password.
 - Next to **Profile scope**, click either **User** or **System**. The default is **User**. This option is available only on OS X 10.7 and later.

7. Configure deployment rules and choose delivery groups. For more information, see [Add a device policy](#).

Siri and dictation policies

Jun 19, 2017

When users ask Siri something or dictate text on managed iOS devices, Apple collects the voice data for purposes of improving Siri. The voice data passes through Apple's cloud-based services, and therefore exists outside the secure XenMobile container. The text that results from dictation, however, remains within the container.

XenMobile allows you to block Siri and dictation services, as your security needs require.

In MAM deployments, the **Block dictation** policy for each app is **On** by default, which disables the device's microphone. Set it to **Off** if you want to allow dictation. You can find the policy in the XenMobile console at **Configure > Apps**. Select the app, click **Edit**, then click **iOS**.

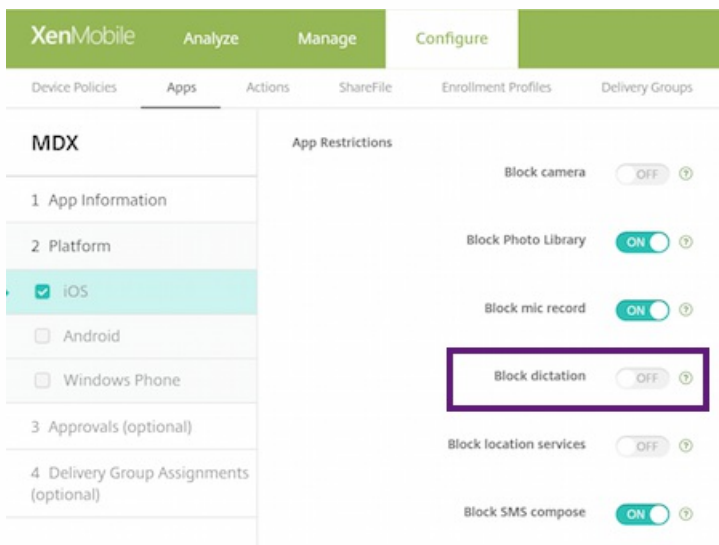

In MDM deployments, you can also disable Siri with the Siri policy at **Configure > Device Policies > Restrictions Policy > iOS**. The use of Siri is allowed by default.

XenMobile Analyze Manage Configure ⚙️ 🔍 admin ▾

Device Policies Apps Actions ShareFile Enrollment Profiles Delivery Groups

Restrictions Policy

1 Policy Info

2 Platforms

- iOS
- Mac OS X
- Samsung SAFE
- Samsung KNOX
- Windows Phone
- Windows Desktop/Tablet
- Amazon
- Windows Mobile/CE

3 Assignment

Restrictions Policy

This policy allows or restricts users from using certain features on their devices, such as the camera. You can also set security restrictions, as well as restrictions on media content and on certain types of apps users can and cannot install.

Allow hardware controls

- Camera ON
- FaceTime
- Screen shots ON
- Photo streams ON iOS 5.0+
- Shared photo streams ON iOS 6.0+
- Voice dialing ON
- Siri ON
- Allow while device is locked
- Siri profanity filter

Back Next >

A few points to keep in mind when deciding whether to allow Siri and dictation:

- According to information that Apple has made public, Apple keeps Siri and dictation voice clip data for up to two years. The data is assigned a random number to represent the user, and voice files are associated with this random number. For more information, see this Wired article, [Apple reveals how long Siri keeps your data](#).
- You can review the Apple privacy policy by going to **Settings > General > Keyboards** on any iOS device and tapping the link under **Enable Dictation**.

SSO account device policy

Jun 19, 2017

You create single sign-on (SSO) accounts in XenMobile to let users sign on one-time only to access XenMobile and your internal company resources from various apps. Users do not need to store any credentials on the device. The SSO account enterprise user credentials are used across apps, including apps from the App Store. This policy is designed to work with a Kerberos authentication backend.

Note: This policy applies only to iOS 7.0 and later.

1. In the XenMobile console, click **Configure > Device Policies**. The **Device Policies** page appears.
2. Click **Add**. The **Add a New Policy** dialog box appears.
3. Click **More** and then, under **End user**, click **SSO Account**. The **SSO Account Policy** page appears.
4. In the **SSO Account Policy information** pane, enter the following information:
 - **Policy Name:** Type a descriptive name for the policy.
 - **Description:** Optionally, type a description of the policy.
5. Click **Next**. The **iOS Platform** information page appears.

SSO Account Policy

1 Policy Info

2 Platforms

iOS

3 Assignment

Policy Information

This policy lets you create a single sign-on (SSO) account profile for iOS 7 and later users.

Account name*

Kerberos principal name*

Identity credential (Keystore or PKI credential) None

Kerberos realm*

Permitted URLs

Permitted URL Add

App Identifiers

App Identifier Add

Policy Settings

Remove policy Select date Duration until removal (in days)

Calendar icon

Allow user to remove policy Always

► Deployment Rules

Back Next >

6. Configure these settings:

- **Account name:** Enter the Kerberos SSO account name that appears on users' devices. This field is required.
- **Kerberos principal name:** Enter the Kerberos principal name. This field is required.
- **Identity credential (Keystore or PKI credential):** In the list, click an optional identity credential that can be used to renew the Kerberos credential without user interaction.
- **Kerberos realm:** Enter the Kerberos realm for this policy. This is typically your domain name in all capital letters (for example, EXAMPLE.COM). This field is required.
- **Permitted URLs:** For each URL for which you want to require SSO, click **Add** and then do the following:
 - **Permitted URL:** Enter a URL that you want to require SSO when a user visits the URL from the iOS device. For example, when a user tries to browse to a site and the web site initiates a Kerberos challenge, if that site is not in the URL list, the iOS device does not attempt SSO by providing the Kerberos token that Kerberos might have cached on the device from a previous Kerberos logon. The match has to be exact on the host part of the URL; for example, http://shopping.apple.com is valid, but http://*.apple.com is not. Also, if Kerberos is not activated based on host matching, the URL still falls back to a standard HTTP call. This could mean almost anything including a standard password challenge or an HTTP error if the URL is only configured for SSO using Kerberos.
 - Click **Add** to add the URL or click **Cancel** to cancel adding the URL.
- **App Identifiers:** For each app that is allowed to use this login, click **Add** and then do the following:
 - **App Identifier:** Enter an app identifier for an app that is allowed to use this login. If you do not add any app

identifiers, this login matches **all** app identifiers.

- Click **Add** to add the app identifier or click **Cancel** to cancel adding the app identifier.

Note: To delete an existing URL or app identifier, hover over the line containing the listing and then click the trash can icon on the right-hand side. A confirmation dialog box appears. Click **Delete** to delete the listing or **Cancel** to keep the listing.

To edit an existing URL or app identifier, hover over the line containing the listing and click the pen icon on the right-hand side. Make any changes to the listing and then click **Save** to save the changed listing or **Cancel** to leave the listing unchanged.

- **Policy Settings**

- Next to **Remove policy**, click either **Select date** or **Duration until removal (in hours)**.
- If you click **Select date**, click the calendar to select the specific date for removal.
- In the **Allow user to remove policy** list, click **Always**, **Password required**, or **Never**.
- If you click **Password required**, next to **Removal password**, type the necessary password.

7. Configure deployment rules and choose delivery groups. For more information, see [Add a device policy](#).

Storage encryption device policy

Jun 19, 2017

You create storage encryption device policies in XenMobile to encrypt internal and external storage, and, depending on the device, to prevent users from using a storage card on their devices.

You can create policies for Samsung SAFE, Windows Phone, and Android Sony devices. Each platform requires a different set of values, which are described in detail in this article.

[Samsung SAFE settings](#)

[Windows Phone settings](#)

[Android Sony settings](#)

Note: For Samsung SAFE devices, before configuring this policy, make sure the following requirements are met:

- You must set the Screen Lock option on users' devices.
- Users' devices must be plugged in and 80% charged.
- The device must require a password containing both numbers and letters or symbols.

1. In the XenMobile console, click **Configure** > **Device Policies**. The **Device Policies** page appears.

2. Click **Add**. The **Add a New Policy** dialog box appears.

3. Click **More** and then, under **Security**, click **Storage Encryption**. The **Storage Encryption Policy** information page appears.

4. In the **Policy Information** pane, type the following information:

- **Policy Name:** Type a descriptive name for the policy.
- **Description:** Type an optional description of the policy.

5. Click **Next**. The **Policy Platforms** page appears.

6. Under **Platforms**, select the platforms you want to add. If you are only configuring for one platform, clear the others.

When you finish configuring the settings for a platform, refer to Step 7 for how to set that platform's deployment rules.

The screenshot shows the XenMobile configuration interface for a Storage Encryption Policy. The left sidebar contains a navigation menu with sections: 1 Policy Info, 2 Platforms, and 3 Assignment. Under '2 Platforms', three options are listed: Samsung SAFE, Windows Phone, and Android Sony, all of which are checked. The main content area is titled 'Policy Information' and includes a descriptive paragraph. Below the text are two toggle switches: 'Encrypt internal storage' (set to ON) and 'Encrypt external storage' (set to ON). A 'Deployment Rules' section is visible below the toggles. At the bottom right, there are 'Back' and 'Next >' buttons.

Configure these settings:

- **Encrypt internal storage:** Select whether to encrypt internal storage on users' devices. Internal storage includes device memory and internal storage. The default is **ON**.
- **Encrypt external storage:** Select whether to encrypt external storage on users' devices. The default is **ON**.

This screenshot shows the same XenMobile configuration interface, but with different settings. The 'Policy Information' section now features two toggle switches: 'Require device encryption' (set to OFF) and 'Disable storage card' (set to OFF). The 'Deployment Rules' section remains visible below. The 'Back' and 'Next >' buttons are still present at the bottom right.

Configure these settings:

- **Require device encryption:** Select whether to encrypt users' devices. The default is **OFF**.
- **Disable storage card:** Select whether to prevent users from using a storage card on their devices. The default is **OFF**.

The screenshot shows the XenMobile configuration interface. At the top, there are navigation tabs: 'Analyze', 'Manage', and 'Configure' (which is active). Below these are sub-tabs: 'Device Policies', 'Apps', 'Actions', 'ShareFile', and 'Delivery Groups'. The main content area is titled 'Storage Encryption Policy' and is divided into three sections: '1 Policy Info', '2 Platforms', and '3 Assignment'. Under '2 Platforms', three options are listed with checkboxes: 'Samsung SAFE', 'Windows Phone', and 'Android Sony' (which is selected). Under '3 Assignment', there are no options listed. The 'Policy Information' section contains the text: 'This policy lets you encrypt stored data and prevent storage card usage depending on the device platform. For Samsung SAFE devices, the Screen Lock option must also be set on the device in order for this policy to work.' Below this text is a toggle switch for 'Encrypt external storage' which is currently turned 'ON'. A 'Deployment Rules' section is partially visible below the toggle. At the bottom right of the main area, there are 'Back' and 'Next >' buttons.

Configure this setting:

- **Encrypt external storage:** Select whether to encrypt external storage on users' devices. The device must require a password containing both numbers and letters or symbols. The default is **ON**.

7. Configure deployment rules and choose delivery groups. For more information, see [Add a device policy](#).

Store device policy

Jun 19, 2017

You can create a policy in XenMobile to specify whether iOS, Android, or Windows Tablet devices display a XenMobile Store webclip on the devices' home screen.

1. In the XenMobile console, click **Configure** > **Device Policies**. The **Device Policies** page appears.
2. Click **Add**. The **Add a New Policy** dialog box appears.
3. Expand **More**, and then under **Apps**, click **Store**. The **Store Policy** page appears.
4. In the **Policy Information** pane, enter the following information:
 - **Policy Name:** Type a descriptive name for the policy.
 - **Description:** If desired, type a description of the policy.
5. Click **Next**. The **Platforms** page appears.

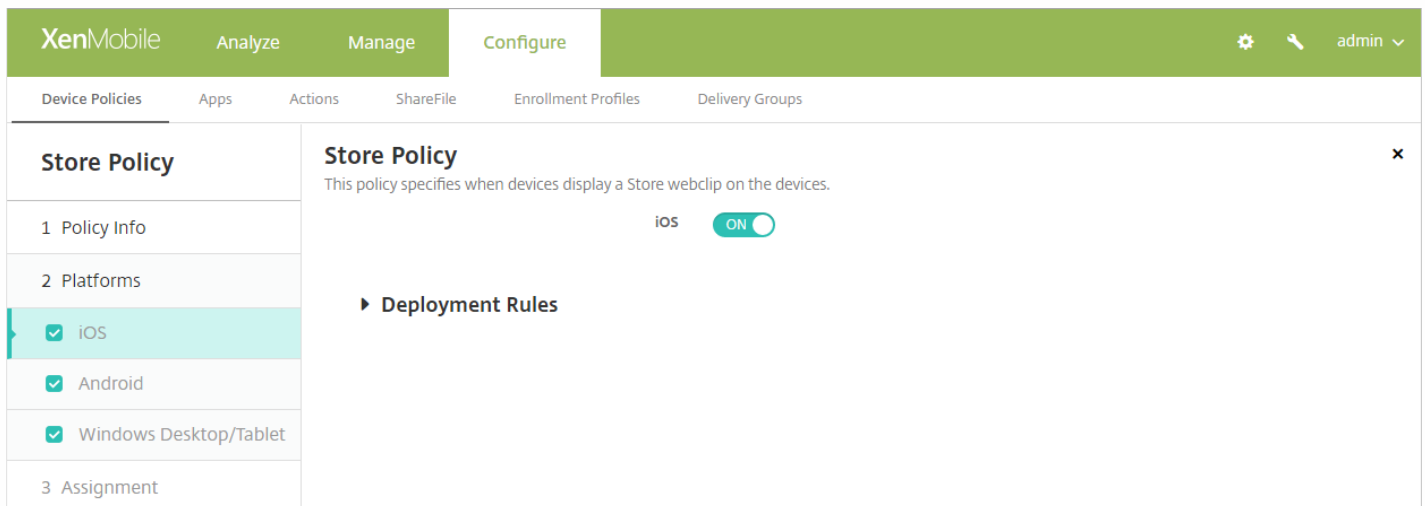

6. Under **Platforms**, select the platforms you want to add. If you are only configuring for one platform, clear the others.
7. For each platform that you configure, select whether a XenMobile Store webclip appears on users' devices. The default is **ON**.

After you configure each platform, refer to Step 8 for how to set that platform's deployment rules.

7. Configure deployment rules and choose delivery groups. For more information, see [Add a device policy](#).

Subscribed calendars device policy

Jun 19, 2017

You can add a device policy in XenMobile to add a subscribed calendar to the calendars list on users' iOS devices. The list of public calendars to which you can subscribe is available at www.apple.com/downloads/macosx/calendars.

Note: You must have subscribed to a calendar before you can add it to the subscribed calendars list on users' devices.

1. In the XenMobile console, click **Configure** > **Device Policies**. The **Device Policies** page appears.
2. Click **Add**. The **Add a New Policy** dialog box appears.
3. Click **More** and then, under **End user**, click **Subscribed Calendars**. The **Subscribed Calendars Policy** page appears.
4. In the **Policy Information** pane, enter the following information:
 - **Policy Name:** Type a descriptive name for the policy.
 - **Description:** Optionally, type a description of the policy.
5. Click **Next**. The **iOS Platform Information** page appears.

The screenshot shows the XenMobile console interface. The top navigation bar includes 'XenMobile', 'Analyze', 'Manage', and 'Configure'. The 'Configure' section is active, showing 'Device Policies', 'Apps', 'Actions', 'ShareFile', and 'Delivery Groups'. The 'Subscribed Calendars Policy' page is displayed, with a sidebar on the left containing '1 Policy Info', '2 Platforms', '3 Assignment', and 'iOS' (selected). The main content area is titled 'Policy Information' and contains the following fields and settings:

- Description***: Text input field.
- URL***: Text input field with a help icon.
- User name***: Text input field.
- Password**: Text input field with a password icon.
- Use SSL**: Toggle switch set to 'OFF'.
- Policy Settings**:
 - Remove policy**: Radio buttons for 'Select date' (selected) and 'Duration until removal (in days)'. A date picker is visible below.
 - Allow user to remove policy**: Dropdown menu set to 'Always'.
- Deployment Rules**: Section header with a right-pointing arrow.

At the bottom right, there are 'Back' and 'Next >' buttons.

6. Configure these settings:

- **Description:** Enter a description of the calendar. This field is required.

- **URL:** Enter the calendar URL. You can enter a webcal:// URL or an http:// link to an iCalendar file (.ics). This field is required.
 - **User name:** Enter the user's logon name. This field is required.
 - **Password:** Enter an optional user password.
 - **Use SSL:** Select whether to use a Secure Socket Layer connection to the calendar. The default is Off.
 - **Policy Settings**
 - Next to **Remove policy**, click either **Select date** or **Duration until removal (in hours)**.
 - If you click **Select date**, click the calendar to select the specific date for removal.
 - In the **Allow user to remove policy** list, click **Always**, **Password required**, or **Never**.
 - If you click **Password required**, next to **Removal password**, type the necessary password.
7. Configure deployment rules and choose delivery groups. For more information, see [Add a device policy](#).

Terms and conditions device policy

Jun 19, 2017

You create terms and conditions device policies in XenMobile when you want users to accept your company's specific policies governing connections to the corporate network. When users enroll their devices with XenMobile, they are presented with the terms and conditions and must accept them to enroll their devices. Declining the terms and conditions cancels the enrollment process.

You can create different policies for terms and conditions in different languages if your company has international users and you want them to accept terms and conditions in their native languages. You must provide a file for each platform and language combination you plan to deploy. For Android and iOS devices, you must supply PDF files. For Windows devices, you must supply text (.txt) files and accompanying image files.

[iOS and Android settings](#)

[Windows Phone and Windows Tablet settings](#)

1. In the XenMobile console, click **Configure > Device Policies**. The **Device Policies** page appears.
2. Click **Add**. The **Add a New Policy** dialog box appears.
3. Click **Terms & Conditions**. The **Terms & Conditions Policy** page appears.
4. In the **Policy Information** pane, enter the following information:
 - **Policy Name**: Type a descriptive name for the policy.
 - **Description**: Optionally, type a description of the policy.
5. Click **Next**. The **Terms & Conditions Platforms** information page appears.

XenMobile Analyze Manage **Configure** admin

Device Policies Apps Actions ShareFile Delivery Groups

Terms & Conditions Policy

This policy lets you upload your own Terms & Conditions file in a preferred language for users to view and accept on their devices. You can upload files in additional languages as well. For Windows Phone/Tablet, the payloads are supported only on Windows 10 and later supervised devices.

File to be imported*

Default Terms & Conditions OFF

Back

Terms & Conditions Policy

- 1 Policy Info
- 2 Platforms
 - iOS
 - Android
 - Windows Phone
 - Windows Tablet
- 3 Assignment

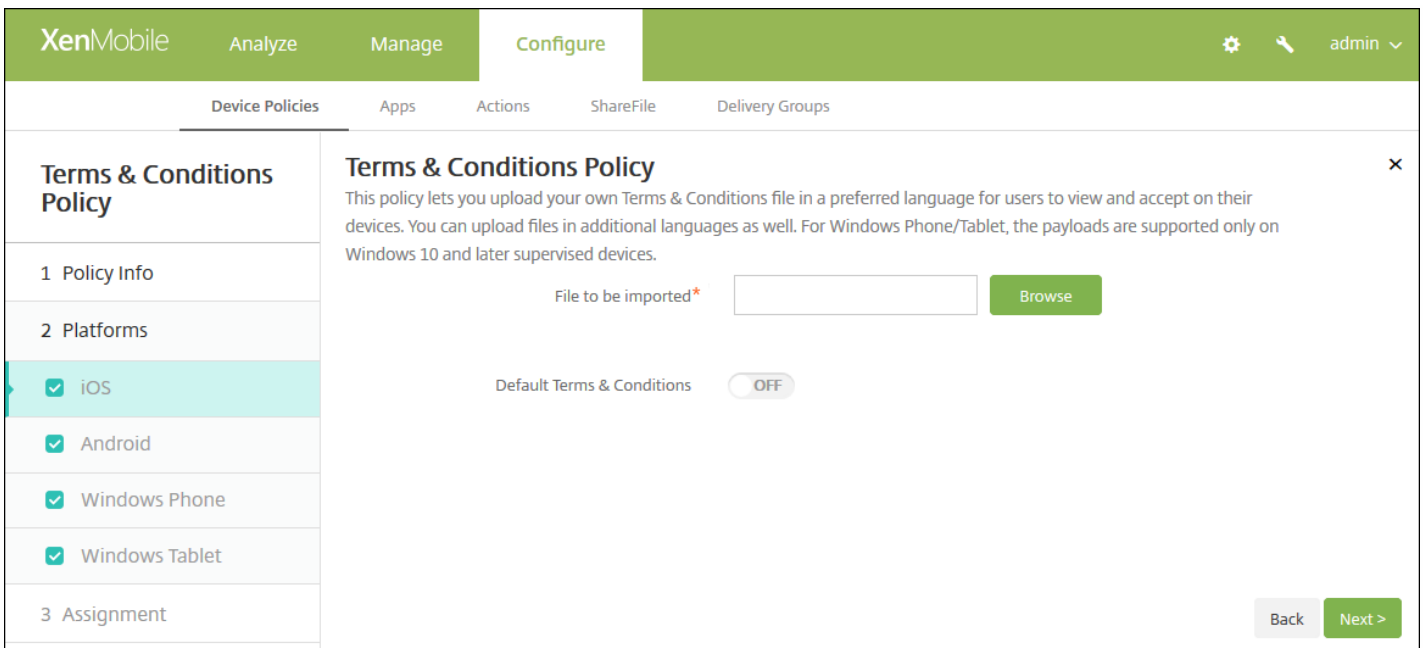

Configure these settings:

- **File to be imported:** Select the terms and conditions file to import by clicking **Browse** and then navigating to the file's location.
- **Default Terms & Conditions:** Select whether this file is the default document for users who are members of multiple groups with different terms and conditions. The default is **OFF**.

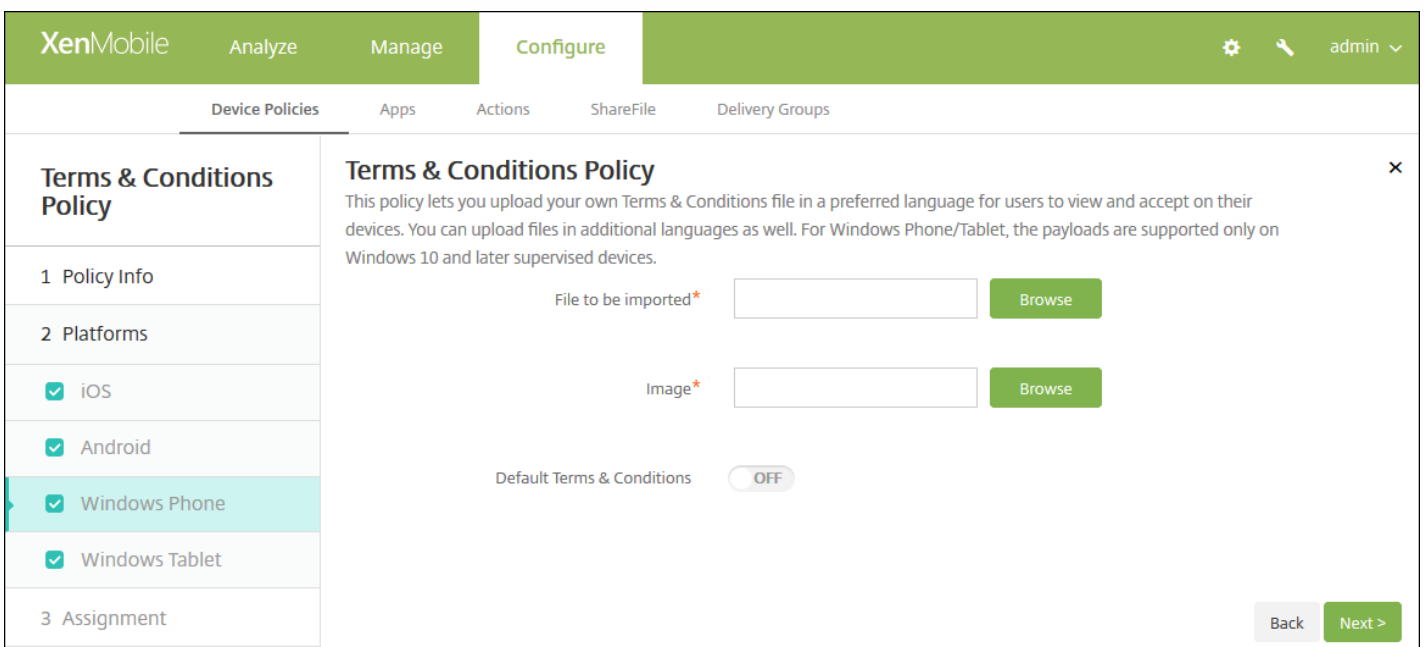

Configure these settings:

- **File to be imported:** Select the terms and conditions file to import by clicking **Browse** and then navigating to the file's

location.

- **Image:** Select the image file to import by clicking **Browse** and then navigating to the file's location.
- **Default Terms & Conditions:** Select whether this file is the default document for users who are members of multiple groups with different terms and conditions. The default is **OFF**.

6. Click **Next**. The **Terms & Conditions Policy** assignment page appears.

The screenshot shows the XenMobile interface for configuring a Terms & Conditions Policy. The top navigation bar includes 'XenMobile', 'Analyze', 'Manage', and 'Configure'. The main content area is titled 'Terms & Conditions Policy' and contains a description of the policy. The left sidebar shows a navigation menu with '1 Policy Info', '2 Platforms', and '3 Assignment'. The '2 Platforms' section is expanded, showing 'iOS', 'Android', 'Windows Phone', and 'Windows Tablet' all selected. The '3 Assignment' section is also expanded, showing a 'Choose delivery groups' section with a search box and a list of groups: 'AllUsers' (checked), 'Sales', and 'RG'. To the right, there is a 'Delivery groups to receive app assignment' list containing 'AllUsers'. At the bottom, there is a 'Deployment Schedule' link and 'Back' and 'Save' buttons.

7. Next to **Choose delivery groups**, type to find a delivery group or select a group or groups in the list to which you want to assign the policy. The groups you select appear in the right-hand **Delivery groups to receive app assignment** list.

8. Click **Save**.

VPN device policy

Jun 28, 2017

You can add a device policy in XenMobile to configure virtual private network (VPN) settings that enable users' devices to connect securely to corporate resources. You can configure the VPN policy for the following platforms: iOS, Android (which includes devices enabled for Android for Work), Samsung SAFE, Samsung KNOX, Windows Tablet, Windows Phone, and Amazon. Each platform requires a different set of values, which are described in detail in this article.

[iOS settings](#)

[Mac OS X settings](#)

[Android settings](#)

[Samsung SAFE settings](#)

[Samsung KNOX settings](#)

[Windows Phone settings](#)

[Windows Tablet settings](#)

[Amazon settings](#)

1. In the XenMobile console, click **Configure** > **Device Policies**. The **Device Policies** page appears.
2. Click **Add**. The **Add a New Policy** dialog box appears.
3. Click **VPN**. The **VPN Policy** page appears.
4. In the **Policy Information** pane, enter the following information:
 - **Policy Name:** Type a descriptive name for the policy.
 - **Description:** Type an optional description of the policy.
5. Click **Next**. The **Policy Platforms** page appears. When the **Policy Platform** page appears, all platforms are selected and you see the iOS platform first.
6. Under **Platforms**, select the platform or platforms you want to add. Clear those platforms that you do not want to configure.

When you finish configuring the settings for a platform, refer to Step 7 for how to set that platform's deployment rules.

XenMobile Analyze Manage **Configure** admin

Device Policies Apps Actions ShareFile Delivery Groups

VPN Policy

- Policy Info
- Platforms
 - iOS
 - Mac OS X
 - Android
 - Samsung SAFE
 - Samsung KNOX
 - Windows Phone
 - Windows Tablet
 - Amazon
- Assignment

Policy Information

This policy lets you configure a VPN connection to provide a device-level encrypted connection to the intranet. For Windows Phone, the payloads are supported only on Windows 10 and later supervised devices.

Connection name

Connection type **L2TP**

Server name or IP address*

User account

Password authentication
 RSA SecureID authentication

Shared secret

Send all traffic **OFF**

Proxy

Proxy configuration **None**

Policy Settings

Remove policy Select date
 Duration until removal (in days)

Allow user to remove policy **Always**

Deployment Rules

Back Next >

Configure these settings

- **Connection name:** Type a name for the connection.
- **Connection type:** In the list, click the protocol to be used for this connection. The default is **L2TP**.
 - **L2TP:** Layer 2 Tunneling Protocol with pre-shared key authentication.
 - **PPTP:** Point-to-Point Tunneling.
 - **IPSec:** Your corporate VPN connection.
 - **Cisco AnyConnect:** Cisco AnyConnect VPN client. This connection type requires that the Cisco AnyConnect VPN client is installed on the user device.
 - **Juniper SSL:** Juniper Networks SSL VPN client.
 - **F5 SSL:** F5 Networks SSL VPN client.
 - **SonicWALL Mobile Connect:** Dell unified VPN client for iOS.
 - **Ariba VIA:** Ariba Networks Virtual Internet Access client.
 - **IKEv2 (iOS only):** Internet Key Exchange version 2 for iOS only.
 - **Citrix VPN:** Citrix VPN client for iOS.

- **Custom SSL:** Custom Secure Socket Layer.

The following sections list the configuration options for each of the preceding connection types.

Configure L2TP Protocol

- **Server name or IP address:** Type the server name or IP address for the VPN server.
- **User Account:** Type an optional user account.
- Select either **Password authentication** or **RSA SecureID authentication**.
- **Shared secret:** Type the IPSec shared secret key.
- **Send all traffic:** Select whether to send all traffic over the VPN. The default is **OFF**.

Configure PPTP Protocol

- **Server name or IP address:** Type the server name or IP address for the VPN server.
- **User Account:** Type an optional user account.
- Select either **Password authentication** or **RSA SecureID authentication**.
- **Encryption level:** In the list, click an encryption level. The default is **None**.
 - **None:** Use no encryption.
 - **Automatic:** Use the strongest encryption level supported by the server.
 - **Maximum (128-bit):** Always use 128-bit encryption.
- **Send all traffic:** Select whether to send all traffic over the VPN. The default is **OFF**.

Configure IPSec Protocol

- **Server name or IP address:** Type the server name or IP address for the VPN server.
- **User Account:** Type an optional user account.
- **Authentication type for the connection:** In the list, click either **Shared Secret** or **Certificate** for the type of authentication for this connection. The default is **Shared Secret**.
- If you enable **Shared Secret**, configure these settings:
 - **Group name:** Type an optional group name.
 - **Shared secret:** Type an optional shared secret key.
 - **Use hybrid authentication:** Select whether to use hybrid authentication. With hybrid authentication, the server first authenticates itself to the client, and then the client authenticates itself to the server. The default is **OFF**.
 - **Prompt for password:** Select whether to prompt users for their passwords when they connect to the network. The default is **OFF**.
- If you enable **Certificate**, configure these settings:
 - **Identity credential:** In the list, click the identity credential to use. The default is **None**.
 - **Prompt for PIN when connecting:** Select whether to require users to enter their PIN when connecting to the network. The default is **OFF**.
 - **Enable VPN on demand:** Select whether to enable triggering a VPN connection when users connect to the network. The default is **OFF**. For information on configuring settings when **Enable VPN on demand** is **ON**, see [Configure Enable VPN on demand options](#).
- **Enable per-app VPN:** Select whether to enable per-app VPN. The default is **OFF**. Available only on iOS 9.0 and later.
- **On-demand match app enabled:** Select whether per-app VPN connections are triggered automatically when apps linked to the per-app VPN service initiate network communication. The default is **OFF**.
- **Safari domains:** Click **Add** to add a Safari domain name.

Configure Cisco AnyConnect Protocol

- **Server name or IP address:** Type the server name or IP address for the VPN server.
- **User Account:** Type an optional user account.
- **Group:** Type an optional group name.
- **Authentication type for the connection:** In the list, click either **Password** or **Certificate** for the type of authentication for this connection. The default is **Password**.
 - If you enable **Password**, type an optional authentication password in the **Auth password** field.
 - If you enable **Certificate**, configure these settings:
 - **Identity credential:** In the list, click the identity credential to use. The default is **None**.
 - **Prompt for PIN when connecting:** Select whether to prompt users for their PIN when they connect to the network. The default is **OFF**.
 - **Enable VPN on demand:** Select whether to enable triggering a VPN connection when users connect to the network. The default is **OFF**. For information on configuring settings when **Enable VPN on demand** is **ON**, see [Configure Enable VPN on demand options](#).
- **Per-app VPN:** Select whether to enable per-app VPN. The default is **OFF**. Available only on iOS 7.0 and later. If you enable this option, configure these settings:
 - **On-demand match enabled:** Select whether per-app VPN connections are triggered automatically when apps linked to the per-app VPN service initiate network communication. The default is **OFF**.
 - **Safari domains:** For each Safari domains that can trigger a per-app VPN connection you want to include, click **Add** and do the following:
 - **Domain:** Type the domain to be added.
 - Click **Save** to save the domain or click **Cancel** to not save the domain.

Note: To delete an existing domain, hover over the line containing the listing and then click the trash can icon on the right-hand side. A confirmation dialog box appears. Click **Delete** to delete the listing or **Cancel** to keep the listing.

To edit an existing domain, hover over the line containing the listing and then click the pen icon on the right-hand side. Make any changes to the listing and then click **Save** to save the changed listing or **Cancel** to leave the listing unchanged.

Configure Juniper SSL Protocol

- **Server name or IP address:** Type the server name or IP address for the VPN server.
- **User account:** Type an optional user account.
- **Realm:** Type an optional realm name.
- **Role:** Type an optional role name.
- **Authentication type for the connection:** In the list, click either **Password** or **Certificate** for the type of authentication for this connection. The default is **Password**.
 - If you enable **Password**, type an optional authentication password in the **Auth password** field.
 - If you enable **Certificate**, configure these settings:
 - **Identity credential:** In the list, click the identity credential to use. The default is **None**.
 - **Prompt for PIN when connecting:** Select whether to prompt users for their PIN when they connect to the network. The default is **OFF**.
 - **Enable VPN on demand:** Select whether to enable triggering a VPN connection when users connect to the network. The default is **OFF**. For information on configuring settings when **Enable VPN on demand** is **ON**, see [Configure Enable VPN on demand settings](#).
- **Per-app VPN:** Select whether to enable per-app VPN. The default is **OFF**. Available only on iOS 7.0 and later. If you enable this option, configure these settings:
 - **On-demand match enabled:** Select whether per-app VPN connections are triggered automatically when apps linked to the per-app VPN service initiate network communication. The default is **OFF**.
 - **Safari domains:** For each Safari domains that can trigger a per-app VPN connection you want to include, click **Add** and do the

following:

- **Domain:** Type the domain to be added.
- Click **Save** to save the domain or click **Cancel** to not save the domain.

Note: To delete an existing domain, hover over the line containing the listing and then click the trash can icon on the right-hand side. A confirmation dialog box appears. Click **Delete** to delete the listing or **Cancel** to keep the listing.

To edit an existing domain, hover over the line containing the listing and then click the pen icon on the right-hand side. Make any changes to the listing and then click **Save** to save the changed listing or **Cancel** to leave the listing unchanged.

Configure F5 SSL Protocol

- **Server name or IP address:** Type the server name or IP address for the VPN server.
- **User Account:** Type an optional user account.
- **Authentication type for the connection:** In the list, click either **Password** or **Certificate** for the type of authentication for this connection. The default is **Password**.
 - If you enable **Password**, type an optional authentication password in the **Auth password** field.
 - If you enable **Certificate**, configure these settings:
 - **Identity credential:** In the list, click the identity credential to use. The default is **None**.
 - **Prompt for PIN when connecting:** Select whether to prompt users for their PIN when they connect to the network. The default is **OFF**.
 - **Enable VPN on demand:** Select whether to enable triggering a VPN connection when users connect to the network. The default is **OFF**. For information on configuring settings when **Enable VPN on demand** is **ON**, see [Configure Enable VPN on demand settings](#).
- **Per-app VPN:** Select whether to enable per-app VPN. The default is **OFF**. Available only on iOS 7.0 and later. If you enable this option, configure these settings:
 - **On-demand match enabled:** Select whether per-app VPN connections are triggered automatically when apps linked to the per-app VPN service initiate network communication.
 - **Safari domains:** For each Safari domains that can trigger a per-app VPN connection you want to include, click **Add** and do the following:
 - **Domain:** Type the domain to be added.
 - Click **Save** to save the domain or click **Cancel** to not save the domain.

Note: To delete an existing domain, hover over the line containing the listing and then click the trash can icon on the right-hand side. A confirmation dialog box appears. Click **Delete** to delete the listing or **Cancel** to keep the listing.

To edit an existing domain, hover over the line containing the listing and then click the pen icon on the right-hand side. Make any changes to the listing and then click **Save** to save the changed listing or **Cancel** to leave the listing unchanged.

Configure SonicWALL Protocol

- **Server name or IP address:** Type the server name or IP address for the VPN server.
- **User Account:** Type an optional user account.
- **Logon group or domain:** Type an optional logon group or domain.
- **Authentication type for the connection:** In the list, click either **Password** or **Certificate** for the type of authentication for this connection. The default is **Password**.
 - If you enable **Password**, type an optional authentication password in the **Auth password** field.
 - If you enable **Certificate**, configure these settings:
 - **Identity credential:** In the list, click the identity credential to use. The default is **None**.
 - **Prompt for PIN when connecting:** Select whether to prompt users for their PIN when they connect to the network. The

default is **OFF**.

- **Enable VPN on demand:** Select whether to enable triggering a VPN connection when users connect to the network. The default is **OFF**. For information on configuring settings when **Enable VPN on demand** is **ON**, see [Configure Enable VPN on demand settings](#).
- **Per-app VPN:** Select whether to enable per-app VPN. The default is **OFF**. Available only on iOS 7.0 and later. If you set this option to **ON**, configure these settings:
 - **On-demand match enabled:** Select whether per-app VPN connections are triggered automatically when apps linked to the per-app VPN service initiate network communication.
 - **Safari domains:** For each Safari domains that can trigger a per-app VPN connection you want to include, click **Add** and do the following:
 - **Domain:** Type the domain to be added.
 - Click **Save** to save the domain or click **Cancel** to not save the domain.

Note: To delete an existing domain, hover over the line containing the listing and then click the trash can icon on the right-hand side. A confirmation dialog box appears. Click **Delete** to delete the listing or **Cancel** to keep the listing.

To edit an existing domain, hover over the line containing the listing and then click the pen icon on the right-hand side. Make any changes to the listing and then click **Save** to save the changed listing or **Cancel** to leave the listing unchanged.

Configure Ariba VIA protocol

- **Server name or IP address:** Type the server name or IP address for the VPN server.
- **User Account:** Type an optional user account.
- **Authentication type for the connection:** In the list, click either **Password** or **Certificate** for the type of authentication for this connection. The default is **Password**.
 - If you enable **Password**, type an optional authentication password in the **Auth password** field.
 - If you enable **Certificate**, configure these settings:
 - **Identity credential:** In the list, click the identity credential to use. The default is **None**.
 - **Prompt for PIN when connecting:** Select whether to prompt users for their PIN when they connect to the network. The default is **OFF**.
 - **Enable VPN on demand:** Select whether to enable triggering a VPN connection when users connect to the network. The default is **OFF**. For information on configuring settings when **Enable VPN on demand** is **ON**, see [Configure Enable VPN on demand settings](#).
- **Per-app VPN:** Select whether to enable per-app VPN. The default is **OFF**. Available only on iOS 7.0 and later. If you enable this option, configure these settings:
 - **On-demand match enabled:** Select whether per-app VPN connections are triggered automatically when apps linked to the per-app VPN service initiate network communication.
 - **Safari domains:** For each Safari domains that can trigger a per-app VPN connection you want to include, click **Add** and do the following:
 - **Domain:** Type the domain to be added.
 - Click **Save** to save the domain or click **Cancel** to not save the domain.

Note: To delete an existing domain, hover over the line containing the listing and then click the trash can icon on the right-hand side. A confirmation dialog box appears. Click **Delete** to delete the listing or **Cancel** to keep the listing.

To edit an existing domain, hover over the line containing the listing and then click the pen icon on the right-hand side. Make any changes to the listing and then click **Save** to save the changed listing or **Cancel** to leave the listing unchanged.

Configure IKEv2 protocols

This section includes settings used for the IKEv2, AlwaysOn IKEv2, and AlwaysOn IKEv2 Dual Configuration protocols.

- **Allow user to disable automatic connection:** For the AlwaysOn protocols. Select whether to allow users to turn off automatic connection to the network on their devices. The default is **OFF**.
- **Host name or IP address for server:** Type the server name or IP address for the VPN server.
- **Local Identifier:** The FQDN or IP address for the IKEv2 client. This field is required.
- **Remote Identifier:** The FQDN or IP address for the VPN server. This field is required.
- **Machine Authentication:** Choose **Shared Secret** or **Certificate** for the type of authentication for this connection. The default is **Shared Secret**.
 - If you choose **Shared Secret**, type an optional shared secret key.
 - If you choose **Certificate**, choose an **Identity credential** to use. The default is **None**.
- **Extended Authentication Enabled:** Select whether to enable Extended Authentication Protocol (EAP). If you choose **ON**, type the **User account** and **Authentication password**. (iOS 8.0 and later)
- **Dead Peer Detection Interval:** Choose how often a peer device is contacted to ensure that the peer device remains reachable. The default is **None**. Options are: (iOS 8.0 and later)
 - **None:** Disable dead peer detection.
 - **Low:** Contact peer every 30 minutes.
 - **Medium:** Contact peer every 10 minutes.
 - **High:** Contact peer every 1 minute.
- **Disable Mobility and Multihoming:** Choose whether to disable this feature. (iOS 9.0+)
- **Use IPv4/IPv6 internal subnet attributes:** Choose whether to enable this feature. (iOS 9.0+)
- **Disable redirects:** Choose whether to disable redirects. (iOS 9.0+)
- **Enable NAT keepalive while the device is asleep:** For the AlwaysOn protocols. Keepalive packets maintain NAT mappings for IKEv2 connections. The chip sends these packets at regular interval when the device is awake. If this setting is on, the chip sends keepalive packets even while the device is asleep. The default interval is 20 seconds over WiFi and 110 seconds over cellular. You can change the interval by using the NAT keepalive interval parameter. (iOS 9.0+)
- **NAT keepalive Interval (seconds):** Defaults to 20 seconds. (iOS 9.0+)
- **Enable Perfect Forward Secrecy:** Choose whether to enable this feature. (iOS 9.0+)
- **DNS server IP addresses:** Optional. A list of DNS server IP address strings. These IP addresses can include a mixture of IPv4 and IPv6 addresses. Click **Add** to type an address.
- **Domain name:** Optional. The primary domain of the tunnel. (iOS 10.0+)
- **Search domains:** Optional. A list of domain strings used to qualify single-label host names fully.
- **Append supplemental match domains to resolver's list:** Optional. Determines whether to append the domains in the

supplemental match domains list to the list of search domains for the resolver. 0 means append; 1 means don't append. Default is 0.

- **Supplemental match domains:** Optional. A list of domain strings used to determine which DNS queries are to use the DNS resolver settings contained in the DNS server addresses. This key creates a split DNS configuration where only hosts in certain domains get resolved by using the DNS resolver of the tunnel. Hosts not in one of the domains in this list get resolved by using the default resolver of the system.

If this parameter contains an empty string, that string is used as the default domain. This is how a split-tunnel configuration can direct all DNS queries first to the VPN DNS servers before the primary DNS servers. If the VPN tunnel becomes the default route of the network, the DNS servers listed become the default resolver. In that case, the supplemental match domains list is ignored.

- **IKE SA Parameters and Child SA Parameters.** Configure these settings for each Security Association (SA) parameters option:
 - **Encryption Algorithm:** In the list, click the IKE encryption algorithm to use. The default is **3DES**.
 - **Integrity Algorithm:** In the list, click the integrity algorithm to use. The default is **SHA1-96**.
 - **Diffie Hellman Group:** In the list, click the Diffie Hellman group number. The default is **2**.
 - **LifeTime in Minutes:** Type an integer between 10 and 1440 representing the SA lifetime (rekey interval). The default is **1440** minutes.
- **Service Exceptions:** For the AlwaysOn protocols. Service exceptions are system services that are exempt from AlwaysOn VPN. Configure these service exceptions settings:
 - **Voice Mail:** In the list, click how to handle the voice mail exception. The default is **Allow traffic via tunnel**.
 - **AirPrint:** In the list, click how to handle the AirPrint exception. The default is **Allow traffic via tunnel**.
 - **Allow traffic from captive web sheet outside the VPN tunnel:** Select whether to allow users to connect to public hotspots outside the VPN tunnel. The default is **OFF**.
 - **Allow traffic from all captive networking apps outside the VPN tunnel:** Select whether to allow all hotspot networking apps outside the VPN tunnel. The default is **OFF**.
 - **Captive networking app bundle identifiers:** For each hotspot networking app bundle identifier that users are allowed to access, click **Add** and type the hotspot networking app **Bundle Identifier**. Click **Save** to save the app bundle identifier.

Note: To delete an existing app bundle identifier, hover over the line containing the listing and then click the trashcan icon on the right side. A confirmation dialog box appears. Click **Delete** to delete the listing or **Cancel** to keep the listing.

To edit an existing app bundle identifier, hover over the line containing the listing and then click the pen icon on the right side. Update the listing and then click **Save** to save the changed listing or **Cancel** to leave the listing unchanged.

- **Proxy configuration:** Choose how the VPN connection routes through a proxy server. Default is **None**.

Configure Citrix VPN protocol

The Citrix VPN client is available in the Apple Store [here](#).

- **Server name or IP address:** Type the server name or IP address for the VPN server.
- **User Account:** Type an optional user account.

- **Authentication type for the connection:** In the list, click either **Password** or **Certificate** for the type of authentication for this connection. The default is **Password**.
 - If you enable **Password**, type an optional authentication password in the **Auth password** field.
 - If you enable **Certificate**, configure these settings:
 - **Identity credential:** In the list, click the identity credential to use. The default is **None**.
 - **Prompt for PIN when connecting:** Select whether to prompt users for their PIN when they connect to the network. The default is **OFF**.
 - **Enable VPN on demand:** Select whether to enable triggering a VPN connection when users connect to the network. The default is **OFF**. For information on configuring settings when **Enable VPN on demand** is **ON**, see [Configure Enable VPN on demand settings](#).
- **Per-app VPN:** Select whether to enable per-app VPN. The default is **OFF**. Available only on iOS 7.0 and later. If you set this option to **ON**, configure the following settings:
 - **On-demand match enabled:** Select whether per-app VPN connections are triggered automatically when apps linked to the per-app VPN service initiate network communication.
 - **Safari domains:** For each Safari domains that can trigger a per-app VPN connection you want to include, click **Add** and do the following:
 - **Domain:** Type the domain to be added.
 - Click **Save** to save the domain or click **Cancel** to not save the domain.

Note: To delete an existing domain, hover over the line containing the listing and then click the trash can icon on the right-hand side. A confirmation dialog box appears. Click **Delete** to delete the listing or **Cancel** to keep the listing.

To edit an existing domain, hover over the line containing the listing and then click the pen icon on the right-hand side. Make any changes to the listing and then click **Save** to save the changed listing or **Cancel** to leave the listing unchanged.

- **Custom XML:** For each custom XML parameter you want to add, click **Add** and specify the key/value pairs. Available parameters are:
 - **disableL3:** Disables system level VPN. Allows only per app VPN. No **Value** is needed.
 - **useragent:** Associates with this device policy any NetScaler policies that are targeted to VPN plugin clients. The **Value** for this key is automatically appended to the VPN plugin for the requests initiated by the plugin.

Note: To delete an existing parameter, hover over the line containing the listing and then click the trash can icon on the right-hand side. A confirmation dialog box appears. Click **Delete** to delete the listing or **Cancel** to keep the listing.

To edit an existing parameter, hover over the line containing the listing and then click the pen icon on the right-hand side. Make any changes to the listing and then click **Save** to save the changed listing or **Cancel** to leave the listing unchanged.

Configure Custom SSL protocol

- **Custom SSL identifier (reverse DNS format):** Set to the bundle identifier.
- **Provider Bundle Identifier:** If the app specified in **Custom SSL identifier** has multiple VPN providers of the same type (App proxy or Packet tunnel), then specify this bundle identifier.
- **Server name or IP address:** Type the server name or IP address for the VPN server.
- **User Account:** Type an optional user account.
- **Authentication type for the connection:** In the list, click either **Password** or **Certificate** for the type of authentication for this connection. The default is **Password**.
 - If you enable **Password**, type an optional authentication password in the **Auth password** field.
 - If you enable **Certificate**, configure these settings:
 - **Identity credential:** In the list, click the identity credential to use. The default is **None**.
 - **Prompt for PIN when connecting:** Select whether to prompt users for their PIN when they connect to the network. The default is **OFF**.
 - **Enable VPN on demand:** Select whether to enable triggering a VPN connection when users connect to the network. The

default is **OFF**. For information on configuring settings when **Enable VPN on demand** is **ON**, see [Configure Enable VPN on demand settings](#).

- **Per-app VPN:** Select whether to enable per-app VPN. The default is **OFF**. Available only on iOS 7.0 and later. If you set this option to **ON**, configure the following settings:
 - **On-demand match enabled:** Select whether per-app VPN connections are triggered automatically when apps linked to the per-app VPN service initiate network communication.
 - **Provider Type:** A provider type indicates whether the provider is a VPN service or proxy service. For VPN service, choose **Packet tunnel**. For proxy service, choose **App proxy**.
 - **Safari domains:** For each Safari domains that can trigger a per-app VPN connection you want to include, click **Add** and do the following:
 - **Domain:** Type the domain to be added.
 - Click **Save** to save the domain or click **Cancel** to not save the domain.

Note: To delete an existing domain, hover over the line containing the listing and then click the trash can icon on the right-hand side. A confirmation dialog box appears. Click **Delete** to delete the listing or **Cancel** to keep the listing.

To edit an existing domain, hover over the line containing the listing and then click the pen icon on the right-hand side. Make any changes to the listing and then click **Save** to save the changed listing or **Cancel** to leave the listing unchanged.

- **Custom XML:** For each custom XML parameter you want to add, click **Add** and do the following:
 - **Parameter name:** Type the name of the parameter to be added.
 - **Value:** Type the value associated with **Parameter name**.
 - Click **Save** to save the parameter or click **Cancel** to not save the parameter.

Note: To delete an existing parameter, hover over the line containing the listing and then click the trash can icon on the right-hand side. A confirmation dialog box appears. Click **Delete** to delete the listing or **Cancel** to keep the listing.

To edit an existing parameter, hover over the line containing the listing and then click the pen icon on the right-hand side. Make any changes to the listing and then click **Save** to save the changed listing or **Cancel** to leave the listing unchanged.

Configure Enable VPN on demand options

- **Proxy**
 - **Proxy configuration:** In the list, click how the VPN connection routes through a proxy server. The default is **None**.
 - If you enable **Manual**, configure these settings:
 - **Host name or IP address for the proxy server:** Type the host name or IP address for the proxy server. This field is required.
 - **Port for the proxy server:** Type the proxy server port number. This field is required.
 - **User name:** Type an optional proxy server user name.
 - **Password:** Type an optional proxy server password.
 - If you configure **Automatic**, configure this setting:
 - **Proxy server URL:** Type the URL for the proxy server. This field is required.
- **Policy Settings**
 - Under **Policy Settings**, next to **Remove policy**, click either **Select date** or **Duration until removal (in hours)**.
 - If you click **Select date**, click the calendar to select the specific date for removal.
 - In the **Allow user to remove policy** list, click **Always**, **Password required**, or **Never**.
 - If you click **Password required**, next to **Removal password**, type the necessary password.

Configure a per-app VPN

Per-app VPN options for iOS are available for these connection types: Cisco AnyConnect, Juniper SSL, F5 SSL, SonicWALL Mobile Connect, Ariba VIA, Citrix VPN, and Custom SSL.

To configure a per-app VPN:

1. In **Configure > Device Policies**, create a VPN policy. For example:

A per-app VPN policy for Secure Hub has the following setting requirements:

- **Connection Name:** Set to **XenMobile**. XenMobile uses the Connection Name as the VPN provider localized description. Secure Hub uses the VPN localized description to differentiate the device-wide provider from the per-app provider.
 - **Connection type:** Set to **Custom SSL**.
 - **Custom SSL Identifier:** Set to the bundle identifier of Secure Hub.
 - **Provider Bundle Identifier:** Set to the bundle identifier of the Secure Hub network extension. That bundle identifier is the Secure Hub bundle identifier, specified in **Custom SSL identifier**, with **.NE** appended.
 - **Provider Type:** Set to **Packet tunnel**.
2. In **Configure > Device Policies**, create an App Attributes policy to associate an app to the per-app VPN policy. For **Per-app VPN identifier**, choose the name of the VPN policy created in Step 1. For **Managed app bundle ID**, choose from the app list or type the app bundle ID. (If you deploy an iOS App Inventory policy, the app list contains apps.)

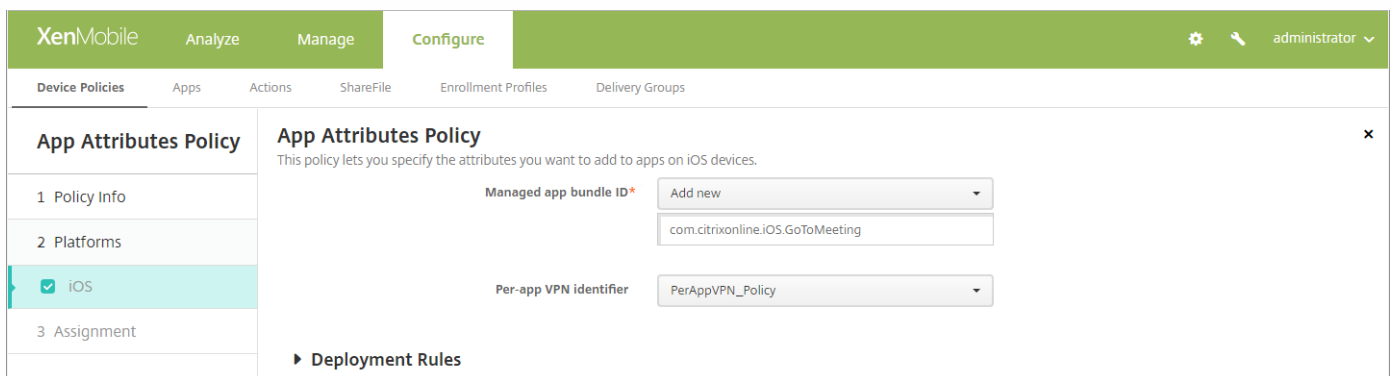

XenMobile Analyze Manage **Configure** ⚙️ 🔍 admin ▾

Device Policies Apps Actions ShareFile Delivery Groups

VPN Policy

- 1 Policy Info
- 2 Platforms
 - iOS
 - Mac OS X
 - Android
 - Samsung SAFE
 - Samsung KNOX
 - Windows Phone
 - Windows Tablet
 - Amazon
- 3 Assignment

Policy Information

This policy lets you configure a VPN connection to provide a device-level encrypted connection to the intranet. For Windows Phone, the payloads are supported only on Windows 10 and later supervised devices.

Connection name

Connection type **L2TP**

Server name or IP address*

User account

Password authentication
 RSA SecureID authentication
 Kerberos authentication
 CryptoCard authentication

Shared secret

Send all traffic **OFF**

Proxy

Proxy configuration **None**

Policy Settings

Remove policy Select date
 Duration until removal (in days)

Allow user to remove policy **Always**

Profile scope **User** OS X 10.7+

Deployment Rules

Back Next >

Configure these settings:

- **Connection name:** Type a name for the connection.
- **Connection type:** In the list, click the protocol to be used for this connection. The default is L2TP.
 - **L2TP:** Layer 2 Tunneling Protocol with pre-shared key authentication.
 - **PPTP:** Point-to-Point Tunneling.
 - **IPSec:** Your corporate VPN connection.
 - **Cisco AnyConnect:** Cisco AnyConnect VPN client.
 - **Juniper SSL:** Juniper Networks SSL VPN client.
 - **F5 SSL:** F5 Networks SSL VPN client.
 - **SonicWALL Mobile Connect:** Dell unified VPN client for iOS.

- **Ariba VIA:** Ariba Networks Virtual Internet Access client.
- **Citrix VPN:** Citrix VPN client.
- **Custom SSL:** Custom Secure Socket Layer.

The following sections list the configuration options for each of the preceding connection types.

Configure L2TP Protocol

- **Server name or IP address:** Type the server name or IP address for the VPN server.
- **User Account:** Type an optional user account.
- Select one of **Password authentication**, **RSA SecureID authentication**, **Kerberos authentication**, **CryptoCard authentication**. The default is **Password authentication**.
- **Shared secret:** Type the IPSec shared secret key.
- **Send all traffic:** Select whether to send all traffic over the VPN. The default is **OFF**.

Configure PPTP Protocol

- **Server name or IP address:** Type the server name or IP address for the VPN server.
- **User Account:** Type an optional user account.
- Select one of **Password authentication**, **RSA SecureID authentication**, **Kerberos authentication**, **CryptoCard authentication**. The default is **Password authentication**.
- **Encryption level:** Select the desired encryption level. The default is **None**.
 - **None:** Use no encryption.
 - **Automatic:** Use the strongest encryption level supported by the server.
 - **Maximum (128-bit):** Always use 128-bit encryption.
- **Send all traffic:** Select whether to send all traffic over the VPN. The default is **OFF**.

Configure IPSec Protocol

- **Server name or IP address:** Type the server name or IP address for the VPN server.
- **User account:** Type an optional user account.
- **Authentication type for the connection:** In the list, click either **Shared Secret** or **Certificate** for the type of authentication for this connection. The default is **Shared Secret**.
 - If you enable **Shared Secret** authentication, configure these settings:
 - **Group name:** Type an optional group name.
 - **Shared secret:** Type an optional shared secret key.
 - **Use hybrid authentication:** Select whether to use hybrid authentication. With hybrid authentication, the server first authenticates itself to the client, and then the client authenticates itself to the server. The default is **OFF**.
 - **Prompt for password:** Select whether to prompt users for their passwords when they connect to the network. The default is **OFF**.
 - If you enable **Certificate** authentication, configure these settings:
 - **Identity credential:** In the list, click the identity credential to use. The default is **None**.
 - **Prompt for PIN when connecting:** Select whether to require users to enter their PIN when connecting to the network. The default is **OFF**.
 - **Enable VPN on demand:** Select whether to enable triggering a VPN connection when users connect to the network. The default is **OFF**. For information on configuring settings when **Enable VPN on demand** is **ON**, see [Configure Enable VPN on demand options](#).

Configure Cisco AnyConnect Protocol

- **Server name or IP address:** Type the server name or IP address for the VPN server.
- **User account:** Type an optional user account.
- **Group:** Type an optional group name.
- **Authentication type for the connection:** In the list, click either **Password** or **Certificate** for the type of authentication for this connection. The default is **Password**.
 - If you enable **Password**, type an optional authentication password in the **Auth password** field.
 - If you enable **Certificate**, configure these settings:
 - **Identity credential:** In the list, click the identity credential to use. The default is **None**.
 - **Prompt for PIN when connecting:** Select whether to prompt users for their PIN when they connect to the network. The default is **OFF**.
 - **Enable VPN on demand:** Select whether to enable triggering a VPN connection when users connect to the network. The default is **OFF**. For information on configuring settings when **Enable VPN on demand** is **ON**, see [Configure Enable VPN on demand options](#).
- **Per-app VPN:** Select whether to enable per-app VPN. The default is **OFF**. If you enable this option, configure these settings:
 - **On-demand match enabled:** Select whether per-app VPN connections are triggered automatically when apps linked to the per-app VPN service initiate network communication. The default is **OFF**.
 - **Safari domains:** For each Safari domains that can trigger a per-app VPN connection you want to include, click **Add** and do the following:
 - **Domain:** Type the domain to be added.
 - Click **Save** to save the domain or click **Cancel** to not save the domain.

Note: To delete an existing domain, hover over the line containing the listing and then click the trash can icon on the right-hand side. A confirmation dialog box appears. Click **Delete** to delete the listing or **Cancel** to keep the listing.

To edit an existing domain, hover over the line containing the listing and then click the pen icon on the right-hand side. Make any changes to the listing and then click **Save** to save the changed listing or **Cancel** to leave the listing unchanged.

Configure Juniper SSL Protocol

- **Server name or IP address:** Type the server name or IP address for the VPN server.
- **User account:** Type an optional user account.
- **Realm:** Type an optional realm name.
- **Role:** Type an optional role name.
- **Authentication type for the connection:** In the list, click either **Password** or **Certificate** for the type of authentication for this connection. The default is **Password**.
 - If you enable **Password**, type an optional authentication password in the **Auth password** field.
 - If you enable **Certificate**, configure these settings:
 - **Identity credential:** In the list, click the identity credential to use. The default is **None**.
 - **Prompt for PIN when connecting:** Select whether to prompt users for their PIN when they connect to the network. The default is **OFF**.
 - **Enable VPN on demand:** Select whether to enable triggering a VPN connection when users connect to the network. The default is **OFF**. For information on configuring settings when **Enable VPN on demand** is **ON**, see [Configure Enable VPN on demand settings](#).
- **Per-app VPN:** Select whether to enable per-app VPN. The default is **OFF**. If you enable this option, configure the following settings:
 - **On-demand match enabled:** Select whether per-app VPN connections are triggered automatically when apps linked to the per-app VPN service initiate network communication. The default is **OFF**.

- **Safari domains:** For each Safari domains that can trigger a per-app VPN connection you want to include, click **Add** and do the following:
 - **Domain:** Type the domain to be added.
 - Click **Save** to save the domain or click **Cancel** to not save the domain.

Note: To delete an existing domain, hover over the line containing the listing and then click the trash can icon on the right-hand side. A confirmation dialog box appears. Click **Delete** to delete the listing or **Cancel** to keep the listing.

To edit an existing domain, hover over the line containing the listing and then click the pen icon on the right-hand side. Make any changes to the listing and then click **Save** to save the changed listing or **Cancel** to leave the listing unchanged.

Configure F5 SSL Protocol

- **Server name or IP address:** Type the server name or IP address for the VPN server.
- **User account:** Type an optional user account.
- **Authentication type for the connection:** In the list, click either **Password** or **Certificate** for the type of authentication for this connection. The default is **Password**.
 - If you enable **Password**, type an optional authentication password in the **Auth password** field.
 - If you enable **Certificate**, configure these settings:
 - **Identity credential:** In the list, click the identity credential to use. The default is **None**.
 - **Prompt for PIN when connecting:** Select whether to prompt users for their PIN when they connect to the network. The default is **OFF**.
 - **Enable VPN on demand:** Select whether to enable triggering a VPN connection when users connect to the network. The default is **OFF**. For information on configuring settings when **Enable VPN on demand** is **ON**, see [Configure Enable VPN on demand settings](#).
- **Per-app VPN:** Select whether to enable per-app VPN. The default is **OFF**. If you enable this option, configure these settings:
 - **On-demand match enabled:** Select whether per-app VPN connections are triggered automatically when apps linked to the per-app VPN service initiate network communication. The default is **OFF**.
 - **Safari domains:** For each Safari domains that can trigger a per-app VPN connection you want to include, click **Add** and do the following:
 - **Domain:** Type the domain to be added.
 - Click **Save** to save the domain or click **Cancel** to not save the domain.

Note: To delete an existing domain, hover over the line containing the listing and then click the trash can icon on the right-hand side. A confirmation dialog box appears. Click **Delete** to delete the listing or **Cancel** to keep the listing.

To edit an existing domain, hover over the line containing the listing and then click the pen icon on the right-hand side. Make any changes to the listing and then click **Save** to save the changed listing or **Cancel** to leave the listing unchanged.

Configure SonicWALL Protocol

- **Server name or IP address:** Type the server name or IP address for the VPN server.
- **User account:** Type an optional user account.
- **Logon group or domain:** Type an optional logon group or domain.
- **Authentication type for the connection:** In the list, click either **Password** or **Certificate** for the type of authentication for this connection. The default is **Password**.
 - If you enable **Password**, type an optional authentication password in the **Auth password** field.
 - If you enable **Certificate**, configure these settings:
 - **Identity credential:** In the list, click the identity credential to use. The default is **None**.
 - **Prompt for PIN when connecting:** Select whether to prompt users for their PIN when they connect to the network. The

default is **OFF**.

- **Enable VPN on demand:** Select whether to enable triggering a VPN connection when users connect to the network. The default is **OFF**. For information on configuring settings when **Enable VPN on demand** is **ON**, see [Configure Enable VPN on demand settings](#).
- **Per-app VPN:** Select whether to enable per-app VPN. The default is **OFF**. If you enable this option, configure these settings:
 - **On-demand match enabled:** Select whether per-app VPN connections are triggered automatically when apps linked to the per-app VPN service initiate network communication. The default is **OFF**.
 - **Safari domains:** For each Safari domains that can trigger a per-app VPN connection you want to include, click **Add** and do the following:
 - **Domain:** Type the domain to be added.
 - Click **Save** to save the domain or click **Cancel** to not save the domain.

Note: To delete an existing domain, hover over the line containing the listing and then click the trash can icon on the right-hand side. A confirmation dialog box appears. Click **Delete** to delete the listing or **Cancel** to keep the listing.

To edit an existing domain, hover over the line containing the listing and then click the pen icon on the right-hand side. Make any changes to the listing and then click **Save** to save the changed listing or **Cancel** to leave the listing unchanged.

Configure Ariba VIA protocol

- **Server name or IP address:** Type the server name or IP address for the VPN server.
- **User account:** Type an optional user account.
- **Authentication type for the connection:** In the list, click either **Password** or **Certificate** for the type of authentication for this connection. The default is **Password**.
 - If you enable **Password**, type an optional authentication password in the **Auth password** field.
 - If you enable **Certificate**, configure these settings:
 - **Identity credential:** In the list, click the identity credential to use. The default is **None**.
 - **Prompt for PIN when connecting:** Select whether to prompt users for their PIN when they connect to the network. The default is **OFF**.
 - **Enable VPN on demand:** Select whether to enable triggering a VPN connection when users connect to the network. The default is **OFF**. For information on configuring settings when **Enable VPN on demand** is **ON**, see [Configure Enable VPN on demand settings](#).
- **Per-app VPN:** Select whether to enable per-app VPN. The default is **OFF**. If you enable this option, configure these settings:
 - **On-demand match enabled:** Select whether per-app VPN connections are triggered automatically when apps linked to the per-app VPN service initiate network communication. The default is **OFF**.
 - **Safari domains:** For each Safari domains that can trigger a per-app VPN connection you want to include, click **Add** and do the following:
 - **Domain:** Type the domain to be added.
 - Click **Save** to save the domain or click **Cancel** to not save the domain.

Note: To delete an existing domain, hover over the line containing the listing and then click the trash can icon on the right-hand side. A confirmation dialog box appears. Click **Delete** to delete the listing or **Cancel** to keep the listing.

To edit an existing domain, hover over the line containing the listing and then click the pen icon on the right-hand side. Make any changes to the listing and then click **Save** to save the changed listing or **Cancel** to leave the listing unchanged.

Configure Citrix VPN protocol

The Citrix VPN client is available in the Apple Store [here](#).

- **Server name or IP address:** Type the server name or IP address for the VPN server.
- **User account:** Type an optional user account.
- **Authentication type for the connection:** In the list, click either **Password** or **Certificate** for the type of authentication for this connection. The default is **Password**.
 - If you enable **Password**, type an optional authentication password in the **Auth password** field.
 - If you enable **Certificate**, configure these settings:
 - **Identity credential:** In the list, click the identity credential to use. The default is **None**.
 - **Prompt for PIN when connecting:** Select whether to prompt users for their PIN when they connect to the network. The default is **OFF**.
 - **Enable VPN on demand:** Select whether to enable triggering a VPN connection when users connect to the network. The default is **OFF**. For information on configuring settings when **Enable VPN on demand** is **ON**, see [Configure Enable VPN on demand settings](#).
- **Per-app VPN:** Select whether to enable per-app VPN. The default is **OFF**. Available only on iOS 7.0 and later. If you enable this option, configure these settings:
 - **On-demand match enabled:** Select whether per-app VPN connections are triggered automatically when apps linked to the per-app VPN service initiate network communication.
 - **Safari domains:** For each Safari domains that can trigger a per-app VPN connection you want to include, click **Add** and do the following:
 - **Domain:** Type the domain to be added.
 - Click **Save** to save the domain or click **Cancel** to not save the domain.

Note: To delete an existing domain, hover over the line containing the listing and then click the trash can icon on the right-hand side. A confirmation dialog box appears. Click **Delete** to delete the listing or **Cancel** to keep the listing.

To edit an existing domain, hover over the line containing the listing and then click the pen icon on the right-hand side. Make any changes to the listing and then click **Save** to save the changed listing or **Cancel** to leave the listing unchanged.

- **Custom XML:** For each custom XML parameter you want to add, click **Add** and specify the key/value pairs. Available parameters are:
 - **disableL3:** Disables system level VPN. Allows only per app VPN. No **Value** is needed.
 - **useragent:** Associates with this device policy any NetScaler policies that are targeted to VPN plugin clients. The **Value** for this key is automatically appended to the VPN plugin for the requests initiated by the plugin.

Note: To delete an existing parameter, hover over the line containing the listing and then click the trash can icon on the right-hand side. A confirmation dialog box appears. Click **Delete** to delete the listing or **Cancel** to keep the listing.

To edit an existing parameter, hover over the line containing the listing and then click the pen icon on the right-hand side. Make any changes to the listing and then click **Save** to save the changed listing or **Cancel** to leave the listing unchanged.

Configure Custom SSL protocol

- **Custom SSL identifier (reverse DNS format):** Type the SSL identifier in reverse DNS format. This field is required.
- **Server name or IP address:** Type the server name or IP address for the VPN server. This field is required.
- **User account:** Type an optional user account.
 - **Authentication type for the connection:** In the list, click either **Password** or **Certificate** for the type of authentication for this connection. The default is **Password**.
 - If you enable **Password**, type an optional authentication password in the **Auth password** field.
 - If you enable **Certificate**, configure these settings:
 - **Identity credential:** In the list, click the identity credential to use. The default is **None**.
 - **Prompt for PIN when connecting:** Select whether to prompt users for their PIN when they connect to the network. The default is **OFF**.
 - **Enable VPN on demand:** Select whether to enable triggering a VPN connection when users connect to the network. The

default is **OFF**. For information on configuring settings when **Enable VPN on demand** is **ON**, see [Configure Enable VPN on demand settings](#).

- **Per-app VPN:** Select whether to enable per-app VPN. The default is **OFF**. If you enable this option, configure these settings:
 - **On-demand match enabled:** Select whether per-app VPN connections are triggered automatically when apps linked to the per-app VPN service initiate network communication.
 - **Safari domains:** For each Safari domains that can trigger a per-app VPN connection you want to include, click **Add** and do the following:
 - **Domain:** Type the domain to be added.
 - Click **Save** to save the domain or click **Cancel** to not save the domain.

Note: To delete an existing domain, hover over the line containing the listing and then click the trash can icon on the right-hand side. A confirmation dialog box appears. Click **Delete** to delete the listing or **Cancel** to keep the listing.

To edit an existing domain, hover over the line containing the listing and then click the pen icon on the right-hand side. Make any changes to the listing and then click **Save** to save the changed listing or **Cancel** to leave the listing unchanged.

- **Custom XML:** For each custom XML parameter you want to add, click **Add** and do the following:
 - **Parameter name:** Type the name of the parameter to be added.
 - **Value:** Type the value associated with **Parameter name**.
 - Click **Save** to save the domain or click **Cancel** to not save the domain.

Note: To delete an existing parameter, hover over the line containing the listing and then click the trash can icon on the right-hand side. A confirmation dialog box appears. Click **Delete** to delete the listing or **Cancel** to keep the listing.

To edit an existing parameter, hover over the line containing the listing and then click the pen icon on the right-hand side. Make any changes to the listing and then click **Save** to save the changed listing or **Cancel** to leave the listing unchanged.

Configure Enable VPN on demand options

- **On Demand Domain:** For each domain and associated action to be taken when users connect to them that you want to add, click **Add** to and do the following:
 - **Domain:** Type the domain to be added.
 - **Action:** In the list click one of the possible actions:
 - **Always establish:** The domain always triggers a VPN connection.
 - **Never establish:** The domain never triggers a VPN connection.
 - **Establish if necessary:** The domain triggers a VPN connection attempt if domain name resolution fails, such as when the DNS server cannot resolve the domain, redirects to a different server, or times out.
 - Click **Save** to save the domain or click **Cancel** to not save the domain.
- **On demand rules**
 - **Action:** In the list, click the action to be taken. The default is **EvaluateConnection**. Possible actions are:
 - **Allow:** Allow VPN on demand to connect when triggered.
 - **Connect:** Unconditionally initiate a VPN connection.
 - **Disconnect:** Remove the VPN connection and do not reconnect on demand as long as the rule matches.
 - **EvaluateConnection:** Evaluate the **ActionParameters** array for each connection.
 - **Ignore:** Leave any existing VPN connection up, but do not reconnect on demand as long as the rule matches.
 - **DNSDomainMatch:** For each domain against which a user device's search domain list can match that you want to add, click **Add** to and do the following:
 - **DNS Domain:** Type the domain name. You can use the wildcard "*" prefix for matching multiple domains. For example, *.example.com matches mydomain.example.com, yourdomain.example.com, and herdomain.example.com.
 - Click **Save** to save the domain or click **Cancel** to not save the domain.

- **DNSServerAddressMatch:** For each IP address to which any of the network's specified DNS servers can match that you want to add, click **Add** and do the following:
 - **DNS Server Address:** Type the DNS server address you want to add. You can use the wildcard "*" suffix for matching DNS servers. For example, 17.* matches any DNS server in the class A subnet.
 - Click **Save** to save the DNS server address or click **Cancel** to not save the DNS server address.
- **InterfaceTypeMatch:** In the list, click the type of primary network interface hardware in use. The default is **Unspecified**. Possible values are:
 - **Unspecified:** Matches any network interface hardware. This is the default.
 - **Ethernet:** Matches only Ethernet network interface hardware.
 - **WiFi:** Matches only WiFi network interface hardware.
 - **Cellular:** Matches only Cellular network interface hardware.
- **SSIDMatch:** For each SSID to match against the current network that you want to add, click **Add** and do the following.
 - **SSID:** Type the SSID to add. If the network is not a WiFi network, or if the SSID does not appear, the match fails. Leave this list empty to match any SSID.
 - Click **Save** to save the SSID or click **Cancel** to not save the SSID.
- **URLStringProbe:** Type a URL to fetch. If this URL is successfully fetched without redirection, this rule matches.
- **ActionParameters : Domains:** For each domain that EvaluateConnection checks that you want to add, click **Add** and do the following:
 - **Domain:** Type the domain to be added.
 - Click **Save** to save the domain or click **Cancel** to not save the domain.
- **ActionParameters : DomainAction:** In the list, click the VPN behavior for the specified **ActionParameters : Domains** domains. The default is **ConnectIfNeeded**. Possible actions are:
 - **ConnectIfNeeded:** The domain triggers a VPN connection attempt if domain name resolution fails, such as when the DNS server cannot resolve the domain, redirects to a different server, or times out.
 - **NeverConnect:** The domain never triggers a VPN connection.
- **ActionParameters: RequiredDNSServers:** For each DNS server IP address to be used for resolving the specified domains, click **Add** and do the following:
 - **DNS Server:** Valid only when **ActionParameters : DomainAction = ConnectIfNeeded**. Type the DNS server to add. This server need not be part of the device's current network configuration. If the DNS server is not reachable, a VPN connection is established in response. This DNS server should be either an internal DNS server or a trusted external DNS server.
 - Click **Save** to save the DNS server or click **Cancel** to not save the DNS server.
- **ActionParameters : RequiredURLStringProbe:** Optionally, type an HTTP or HTTPS (preferred) URL to probe, using a GET request. If the URL's hostname cannot be resolved, if the server is unreachable, or if the server does not respond with a 200 HTTP status code, a VPN connection is established in response. Valid only when **ActionParameters : DomainAction = ConnectIfNeeded**.
- **OnDemandRules : XML content:** Type, or copy and paste, XML configure on demand rules.
 - Click **Check Dictionary** to validate the XML code. You will see Valid XML in green text below the XML content text box if the XML is valid; otherwise, you will see an error message in orange text describing the error.

Proxy

- **Proxy configuration:** In the list, click how the VPN connection routes through a proxy server. The default is **None**.
 - If you enable **Manual**, configure these settings:
 - **Host name or IP address for the proxy server:** Type the host name or IP address for the proxy server. This field is required.
 - **Port for the proxy server:** Type the proxy server port number. This field is required.
 - **User name:** Type an optional proxy server user name.
 - **Password:** Type an optional proxy server password.
 - If you configure **Automatic**, configure this setting:
 - **Proxy server URL:** Type the URL for the proxy server. This field is required.
- **Policy Settings**

- Under **Policy Settings**, next to **Remove policy**, click either **Select date** or **Duration until removal (in hours)**.
- If you click **Select date**, click the calendar to select the specific date for removal.
- In the **Allow user to remove policy** list, click **Always**, **Password required**, or **Never**.
- If you click **Password required**, next to **Removal password**, type the necessary password.
- Next to **Profile scope**, click either **User** or **System**. The default is **User**. This option is available only on OS X 10.7 and later.

VPN Policy

This policy lets you configure a VPN connection to provide a device-level encrypted connection to the intranet. For Windows Phone, the policy is supported only on Windows 10 and later supervised devices.

Connection name*

Server name or IP address*

Connection type

Authentication type for the connection

User name

Password

Identity credential

Per-app VPN

Enable per-app VPN

Custom XML

Custom parameters

Parameter name*	Value	Add
		<input type="button" value="Add"/>

Configure these settings for **Citrix VPN**:

- **Connection name:** Type a name for the VPN connection. This field is required.
- **Server name or IP address:** Type the FQDN or IP address of the NetScaler Gateway.
- **Authentication type for the connection:** Choose an authentication type and complete any of these fields that appear for the type:
 - **User name and Password:** Type your VPN credentials for the **Authentication types** of **Password** or **Password and Certificate**. Optional. If you don't provide the VPN credentials, the Citrix VPN app prompts for a user name and password.
 - **Identity credential:** Appears for the **Authentication types** of **Certificate** or **Password and Certificate**.
- **Enable per-app VPN:** Select whether to enable per-app VPN. If you don't enable per-app VPN, all traffic goes through the Citrix VPN tunnel. If you enable per-app VPN, specify the following settings. The default is **OFF**.
- **Whitelist or Blacklist:** Choose a setting. If **Whitelist**, all apps in the whitelist tunnel through this VPN. If **Blacklist**, all

apps except those on the blacklist tunnel through this VPN.

- **Application List:** Specify the whitelisted or blacklisted apps. Click **Add** and then type a comma-separated list of app package names.
- **Custom XML:** Click **Add** and then type custom parameters. XenMobile supports these parameters for Citrix VPN:
 - **disableL3Mode:** Optional. To enable this parameter, type **Yes** for the **Value**. If enabled, XenMobile doesn't display user-added VPN connections and the user cannot add a new connection. This is a global restriction and applies to all VPN profiles.
 - **userAgent:** A string value. You can specify a custom User Agent string to send in each HTTP request. The specified user agent string gets appended to the existing Citrix VPN user agent.

Configure these settings for **Cisco AnyConnect VPN**:

- **Connection name:** Type a name for the Cisco AnyConnect VPN connection. This field is required.
- **Server name or IP address:** Type the name or IP address of the VPN server. This field is required.
- **Backup VPN server:** Type the backup VPN server information.
- **User group:** Type the user group information.
- **Identity credential:** In the list, select an identity credential.
- **Trusted Networks**
 - **Automatic VPN policy:** Enable or disable this option to set how the VPN reacts to trusted and untrusted networks. If enabled, configure these settings:
 - **Trusted network policy:** In the list, click the desired policy. The default is **Disconnect**. Possible options are:
 - **Disconnect:** The client terminates the VPN connection in the trusted network. This is the default.
 - **Connect:** The client initiates a VPN connection in the trusted network.
 - **Do Nothing:** The client takes no action.
 - **Pause:** Suspends the VPN session (rather than disconnecting it) when a user enters a network configured as trusted after establishing a VPN session outside the trusted network. When the user leaves the trusted network again, the session resumes. This eliminates the need to establish a new VPN session after leaving a trusted network.
 - **Untrusted network policy:** In the list, click the desired policy. The default is **Connect**. Possible options are:
 - **Connect:** The client initiates a VPN connection in the untrusted network.
 - **Do Nothing:** The client starts a VPN connection in the untrusted network. This option disables always-on VPN.
 - **Trusted domains:** For each domain suffix that the network interface may have when the client is in the trusted network, click **Add** to do the following:
 - **Domain:** Type the domain to be added.
 - Click **Save** to save the domain or click **Cancel** to not save the domain.
 - **Trusted servers:** For each server address that a network interface may have when the client is in the trusted network, click **Add** and do the following:
 - **Servers:** Type the server to be added.
 - Click **Save** to save the server or click **Cancel** to not save the server.

Note: To delete an existing server, hover over the line containing the listing and then click the trash can icon on the right-hand side. A confirmation dialog box appears. Click **Delete** to delete the listing or **Cancel** to keep the listing.

To edit an existing server, hover over the line containing the listing and then click the pen icon on the right-hand

side. Make any changes to the listing and then click **Save** to save the changed listing or **Cancel** to leave the listing unchanged.

The screenshot shows the XenMobile configuration interface. At the top, there are tabs for 'Analyze', 'Manage', and 'Configure'. Below these are sub-tabs for 'Device Policies', 'Apps', 'Actions', 'ShareFile', and 'Delivery Groups'. The main content area is titled 'VPN Policy' and is divided into three sections: '1 Policy Info', '2 Platforms', and '3 Assignment'. The '2 Platforms' section is expanded, showing a list of operating systems and devices with checkboxes: iOS, Mac OS X, Android, Samsung SAFE (highlighted), Samsung KNOX, Windows Phone, Windows Tablet, and Amazon. The 'Policy Information' section contains the following fields: 'Connection name*' (text input), 'Vpn Type' (dropdown menu set to 'L2TP with pre-shared key'), 'Host name*' (text input), 'User name' (text input), 'Password' (password input), and 'Pre-shared key*' (password input). Below this is the 'Deployment Rules' section, which is currently empty. At the bottom right, there are 'Back' and 'Next >' buttons.

Configure these settings:

- **Connection name:** Type a name for the connection.
- **Vpn type:** In the list, click the protocol to be used for this connection. The default is **L2TP with pre-shared key**. Possible options are:
 - **L2TP with pre-shared key:** Layer 2 Tunneling Protocol with pre-shared key authentication. This is the default setting.
 - **L2TP with certificate:** Layer 2 Tunneling Protocol with certificate.
 - **PPTP:** Point-to-Point Tunneling.
 - **Enterprise:** Your corporate VPN connection. Applicable to SAFE versions earlier than 2.0.
 - **Generic:** A generic VPN connection. Applicable to SAFE versions 2.0 or higher.

The following sections list the configuration options for each of the preceding VPN types.

Configure L2TP with pre-shared key protocol

- **Host name:** Type the name of the VPN host. This option is required.
- **User name:** Type an optional user name.
- **Password:** Type an optional password.
- **Pre-shared key:** Type the pre-shared key. This option is required.

Configure L2TP with certificate protocol

- **Host name:** Type the name of the VPN host. This option is required.
- **User name:** Type an optional user name.
- **Password:** Type an optional password.
- **Identity credential:** In the list, click the identity credential to be used. The default is **None**.

Configure PPTP protocol

- **Host name:** Type the name of the VPN host. This option is required.
- **User name:** Type an optional user name.
- **Password:** Type an optional password.
- **Enable encryption:** Select whether to enable encryption on the VPN connection.

Configure Enterprise protocol

- **Host name:** Type the name of the VPN host. This option is required.
- **Enable backup server:** Select whether to enable a backup VPN server. If enabled, in **Backup VPN server**, type the FQDN or IP address of the backup VPN server.
- **Enable user authentication:** Select whether to require user authentication. If enabled, configure the following settings:
 - **User name:** Type a user name.
 - **Password:** Type the user password.
- **Group name:** Type an optional group name.
- **Authentication method:** In the list, click the authentication method to be used. Possible options are:
 - **Certificate:** Use certificate authentication. This is the default. If selected, in the Identity credential list, click the credential to use. The default is **None**.
 - **Pre-shared key:** Use a pre-shared key. If selected, in the Pre-shared key field, type the shared secret key.
 - **Hybrid RSA:** Use hybrid authentication using RSA certificates.
 - **EAP MD5:** Authenticate the EAP peer to the EAP server, but does no mutual authentication.
 - **EAP MSCHAPV2:** Use Microsoft's challenge-handshake authentication for mutual authentication.
- **CA certificate:** In the list, click the certificate to be used. The default is **None**.
- **Enable default route:** Select whether to enable a default route to the VPN server. The default is **OFF**.
- **Enable smartcard authentication:** Select whether to allow users to authenticate by using smart cards. The default is **OFF**.
- **Enable mobile option:** Select whether to enable mobile option. The default is **OFF**.
- **Diffie-Hellman group value (key strength):** In the list, click the key strength to be used. The default is 0.
- **Split tunnel type:** In the list, click the type of split tunnel to use. The default is **Auto**. Possible options are:
 - **Auto:** Split tunneling is used automatically.
 - **Manual:** Split tunneling is used over the IP address and port specified on the VPN server.
 - **Disabled:** Split tunneling is not used.
- **SuiteB type:** In the list, click the level of NSA Suite B encryption to use. The default is **GCM-128**. Possible options are:
 - **GCM-128:** Use 128-bit AES-GCM encryption
 - **GMAC-128:** Use 128-bit AES-GMAC encryption.
 - **GMAC-256:** Use 256-bit AES-GMAC encryption.
 - **None:** Use no encryption.
- **Forward routes:** If your corporate VPN server supports forwarding routes, for each forwarding route to use, click **Add** and do the following:
 - **Forward route:** Type the IP address for the forwarding route.
 - Click **Save** to save the route or click **Cancel** to not save the route.

Configure Generic protocol

- **Host name:** Type the name of the VPN host. This option is required.
- **Enable user authentication:** Select whether to require user authentication. If enabled, in **Password**, type the user password.
- **User name:** Type a user name.
- **Package Name Agent VPN:** The package name, or ID, of the VPN installed on the device; for example, Mocana or Pulse Secure.
- **Vpn Connection type:** In the list, click either **IPSEC** or **SSL** for the connection type to be used. The default is **IPSEC**. The following sections describe the configuration settings for each connection type.

Configure IPSEC connection type settings

- **Identity:** Type an optional identifier for this configuration.
- **IPsec group ID type:** In the list, click the IPsec group ID type to use. The default is **Default**. Possible options are:
 - **Default**
 - **IPv4 address**
 - **Fully qualified domain name (FQDN)**
 - **User FQDN**
 - **IKE key ID**
- **IKE version:** In the list, click the Internet Key Exchange version to use. The default is **IKEv1**.
- **Authentication method:** In the list, click the authentication method to be used. The default is **Certificate**. Possible options are:
 - **Certificate:** Use certificate authentication. If selected, in the **Identity credential** list, click the credential to use. The default is **None**.
 - **Pre-shared key:** Use a pre-shared key. If selected, in the **Pre-shared key** field, type the shared secret key.
 - **Hybrid RSA:** Use hybrid authentication using RSA certificates.
 - **EAP MD5:** Authenticate the EAP peer to the EAP server, but does no mutual authentication.
 - **EAP MSCHAPv2:** Use Microsoft's challenge-handshake authentication for mutual authentication.
 - **CAC based Authentication:** Use a Common Access Card (CAC) for authentication.
- **Identity credential:** In the list click the identity credential to use. The default is **None**.
- **CA certificate:** In the list, click the certificate to be used.
- **Enable dead peer detection:** Select whether to contact a peer to ensure that it remains alive. The default is **OFF**.
- **Enable default route:** Select whether to enable a default route to the VPN server.
- **Enable mobile option:** Select whether to enable mobile option.
- **Ike LifeTime in Minutes:** Type the number of minutes before the VPN connection must be reestablished. The default is 1440 minutes (24 hours).
- **Diffie-Hellman group value (key strength):** In the list, click the key strength to be used. The default is 0.
- **IKE Phase 1 key exchange mode:** Select either **Main** or **Aggressive** for the IKE Phase 1 negotiation mode. The default is **Main**.
 - **Main:** No information is exposed to potential attackers during negotiation, but is slower than **Aggressive** mode.
 - **Aggressive:** Some information (for example, the identity of the negotiating peers) is exposed to potential attackers during negotiation, but is faster than **Main** mode.
- **Perfect forward secrecy (PFS) value:** Select whether to use PFS to require a new key exchange renegotiating a connection.
- **Split tunnel type:** In the list, click the type of split tunnel to use. Possible options are:
 - **Auto:** Split tunneling is automatically used.
 - **Manual:** Split tunneling is used over the IP address and port specified on the VPN server.
 - **Disabled:** Split tunneling is not used.
- **IPSEC Encryption algorithm:** A VPN configuration that the IPsec protocol uses.
- **IKE Encryption Algorithm:** A VPN configuration that the IPsec protocol uses.
- **IKE Integrity Algorithm:** A VPN configuration that the IPsec protocol uses.
- **Vendor:** A personal profile for generic agents that communicate with the KNOX API.
- **Forward routes:** If your corporate VPN server supports forwarding routes, for each forwarding route to use, click **Add** and do the following:
 - **Forward route:** Type the IP address for the forwarding route.
 - Click **Save** to save the route or click **Cancel** to not save the route.

- **Per App Vpn:** For each per-app VPN you want to add, click **Add** and do the following:
 - **Per App Vpn:** The VPN configuration that the app uses to communicate.
 - Click **Save** to save the per-app VPN or click **Cancel** to not save the per-app VPN.

Configure SSL connection type settings

- **Authentication method:** In the list, click the authentication method to be used. The default is **Not Applicable**. Possible options are:
 - **Not Applicable**
 - **Certificate:** Use certificate authentication. If selected, in the **Identity credential** list, click the credential to use. The default is **None**.
 - **CAC based Authentication:** Use a Common Access Card (CAC) for authentication.
- **CA certificate:** In the list, click the certificate to be used.
- **Enable default route:** Select whether to enable a default route to the VPN server.
- **Enable mobile option:** Select whether to enable mobile option.
- **Split tunnel type:** In the list, click the type of split tunnel to use. Possible options are:
 - **Auto:** Split tunneling is automatically used.
 - **Manual:** Split tunneling is used over the IP address and port specified on the VPN server.
 - **Disabled:** Split tunneling is not used.
- **SSL Algorithm:** Type the SSL algorithm to use for client-server negotiation.
- **Vendor:** A personal profile for generic agents that communicate with the KNOX API.
- **Forward routes:** If your corporate VPN server supports forwarding routes, for each forwarding route to use, click **Add** and do the following:
 - **Forward route:** Type the IP address for the forwarding route.
 - Click **Save** to save the route or click **Cancel** to not save the route.
- **Per App Vpn:** For each per-app VPN you want to add, click **Add** and do the following:
 - **Per App Vpn:** The VPN configuration that the app uses to communicate.
 - Click **Save** to save the per-app VPN or click **Cancel** to not save the per-app VPN.

XenMobile Analyze Manage **Configure** ⚙️ 🔍 admin ▾

Device Policies Apps Actions ShareFile Delivery Groups

VPN Policy

- 1 Policy Info
- 2 Platforms
 - iOS
 - Mac OS X
 - Android
 - Samsung SAFE
 - Samsung KNOX**
 - Windows Phone
 - Windows Tablet
 - Amazon
- 3 Assignment

Policy Information

This policy lets you configure a VPN connection to provide a device-level encrypted connection to the intranet. For Windows Phone, the payloads are supported only on Windows 10 and later supervised devices.

Vpn Type: Enterprise

Connection name*:

Host name*:

Enable backup server: OFF

Enable user authentication: OFF

Group name:

Authentication method: Certificate

Identity credential: None

CA certificate: Select certificate

Enable default route: OFF

Enable smartcard authentication: OFF

Enable mobile option: OFF

Diffie-Hellman group value (key strength): 0

Split tunnel type: Auto

SuiteB Type: GCM-128

Forward routes

Forward route

Forward route	Add
	<input type="button" value="Add"/>

► **Deployment Rules**

Back Next >

Note: When you configure any policy for Samsung KNOX, it applies only inside the Samsung KNOX container.

Configure these settings:

- **Vpn Type:** In the list, click the type of VPN connection to configure, either **Enterprise** (applicable to KNOX versions earlier than 2.0) or **Generic** (applicable to KNOX versions 2.0 or higher). The default is **Enterprise**.

The following sections list the configuration options for each of the preceding connection types.

Configure Enterprise protocol

- **Connection name:** Type a name for the connection. This field is required.
- **Host name:** Type the name of the VPN host. This option is required.
- **Enable backup server:** Select whether to enable a backup VPN server. If enabled, in **Backup VPN server**, type the FQDN or IP address of the backup VPN server.
- **Enable user authentication:** Select whether to require user authentication. If enabled, configure the following settings:
 - **User name:** Type a user name.
 - **Password:** Type the user password.
- **Group name:** Type an optional group name.
- **Authentication method:** In the list, click the authentication method to be used. Possible options are:
 - **Certificate:** Use certificate authentication. This is the default. If selected, in the Identity credential list, click the credential to use. The default is None.
 - **Pre-shared key:** Use a pre-shared key. If selected, in the Pre-shared key field, type the shared secret key.
 - **Hybrid RSA:** Use hybrid authentication using RSA certificates.
 - **EAP MD5:** Authenticate the EAP peer to the EAP server, but does no mutual authentication.
 - **EAP MSCHAPv2:** Use Microsoft's challenge-handshake authentication for mutual authentication.
- **CA certificate:** In the list, click the certificate to be used.
- **Enable default route:** Select whether to enable a default route to the VPN server.
- **Enable smartcard authentication:** Select whether to allow users to authenticate by using smart cards. The default is **OFF**.
- **Enable mobile option:** Select whether to enable mobile option.
- **Diffie-Hellman group value (key strength):** In the list, click the key strength to be used. The default is **0**.
- **Split tunnel type:** In the list, click the type of split tunnel to use. Possible options are:
 - **Auto:** Split tunneling is automatically used.
 - **Manual:** Split tunneling is used over the IP address and port specified on the VPN server.
 - **Disabled:** No split tunneling is used.
- **Suite B type:** In the list, click the level of NSA Suite B encryption to use. Possible options are:
 - **GCM-128:** Use 128-bit AES-GCM encryption: This is the default.
 - **GCM-256:** Use 256-bit AES-GCM encryption.
 - **GMAC-128:** Use 128-bit AES-GMAC encryption.
 - **GMAC-256:** Use 256-bit AES-GMAC encryption.
 - **None:** Use no encryption.
- **Forward routes:** Click **Add** to add any optional forwarding routes if your corporate VPN server supports multiple route tables.

Configure generic protocol

- **Connection name:** Type a name for the connection. This field is required.
- **Package Name Agent VPN:** The package name, or ID, of the VPN installed on the device; for example, Mocana or Pulse Secure.
- **Host name:** Type the name of the VPN host. This option is required.
- **Enable user authentication:** Select whether to require user authentication. If enabled, configure the following settings:
 - **User name:** Type a user name.
 - **Password:** Type the user password.
- **Identity:** Type an optional identifier for this configuration. Only applies when **Vpn Connection type** = **IPSEC**.
- **Vpn Connection type:** In the list, click either **IPSEC** or **SSL** for the connection type to be used. The default is **IPSEC**. The following sections describe the configuration settings for each connection type.
- **Configure IPSEC connection settings**
 - **Identity:** Type an optional identifier for this configuration.
 - **IPsec group ID type:** In the list, click the IPsec group ID type to use. The default is **Default**. Possible options are:
 - **Default**
 - **IPv4 address**

- Fully qualified domain name (FQDN)
- User FQDN
- IKE key ID
- **IKE version:** In the list, click the Internet Key Exchange version to use. The default is **IKEv1**.
- **Authentication method:** In the list, click the authentication method to be used. The default is **Certificate**. Possible options are:
 - **Certificate:** Use certificate authentication. If selected, in the **Identity credential** list, click the credential to use. The default is **None**.
 - **Pre-shared key:** Use a pre-shared key. If selected, in the **Pre-shared key** field, type the shared secret key.
 - **Hybrid RSA:** Use hybrid authentication using RSA certificates.
 - **EAP MD5:** Authenticate the EAP peer to the EAP server, but does no mutual authentication.
 - **EAP MSCHAPv2:** Use Microsoft's challenge-handshake authentication for mutual authentication.
 - **CAC based Authentication:** Use a Common Access Card (CAC) for authentication.
- **CA certificate:** In the list, click the certificate to be used.
- **Enable dead peer detection:** Select whether to contact a peer to ensure that it remains alive. The default is **OFF**.
- **Enable default route:** Select whether to enable a default route to the VPN server.
- **Enable mobile option:** Select whether to enable mobile option.
- **Ike LifeTime in Minutes:** Type the number of minutes before the VPN connection must be reestablished. The default is 1440 minutes (24 hours).
- **ipsec LifeTime in Minutes:** Type the number of minutes before the VPN connection must be reestablished. The default is 1440 minutes (24 hours).
- **Diffie-Hellman group value (key strength):** In the list, click the key strength to be used. The default is 0.
- **IKE Phase 1 key exchange mode:** Select either **Main** or **Aggressive** for the IKE Phase 1 negotiation mode. The default is **Main**.
 - **Main:** No information is exposed to potential attackers during negotiation, but is slower than **Aggressive** mode.
 - **Aggressive:** Some information (for example, the identity of the negotiating peers) is exposed to potential attackers during negotiation, but is faster than **Main** mode.
- **Perfect forward secrecy (PFS) value:** Select whether to use PFS to require a new key exchange renegotiating a connection.
- **Split tunnel type:** In the list, click the type of split tunnel to use. Possible options are:
 - **Auto:** Split tunneling is automatically used.
 - **Manual:** Split tunneling is used over the IP address and port specified on the VPN server.
 - **Disabled:** Split tunneling is not used.
- **SuiteB Type:** In the list, click the level of NSA Suite B encryption to use. The default is **GCM-128**. Possible options are:
 - **GCM-128:** Use 128-bit AES-GCM encryption.
 - **GCM-256:** Use 256-bit AES-GCM encryption.
 - **GMAC-128:** Use 128-bit AES-GMAC encryption.
 - **GMAC-256:** Use 256-bit AES-GMAC encryption.
 - **None:** Use no encryption.
- **IPSEC Encryption algorithm:** VPN configuration that the IPsec protocol uses.
- **IKE Encryption Algorithm:** VPN configuration that the IPsec protocol uses.
- **IKE Integrity Algorithm:** VPN configuration that the IPsec protocol uses.
- **Knox:** Configurations for Samsung KNOX only.
- **Vendor:** A personal profile for generic agents that communicate with the KNOX API.
- **Forward routes:** If your corporate VPN server supports forwarding routes, for each forwarding route to use, click **Add** and do the following:
 - **Forward route:** Type the IP address for the forwarding route.
 - Click **Save** to save the route or click **Cancel** to not save the route.
- **Per App Vpn:** For each per-app VPN you want to add, click **Add** and do the following:
 - **Per App Vpn:** The VPN configuration the app uses to communicate.
 - Click **Save** to save the per-app VPN or click **Cancel** to not save the per-app VPN.
- **Configure SSL connection settings**
 - **Authentication method:** In the list, click the authentication method to use. Possible options are:

- **Not Applicable:** No authentication method applies. This is the default.
- **Certificate:** Use certificate authentication. This is the default. If selected, in the Identity credential list, click the credential to use. The default is None.
- **CAC based Authentication:** Use a Common Access Card (CAC) for authentication.
- **CA certificate:** In the list, click the certificate to be used.
- **Enable default route:** Select whether to enable a default route to the VPN server.
- **Enable mobile option:** Select whether to enable mobile option.
- **Split tunnel type:** In the list, click the type of split tunnel to use. Possible options are:
 - **Auto:** Split tunneling is automatically used.
 - **Manual:** Split tunneling is used over the IP address and port specified.
 - **Disabled:** No split tunneling is used.
- **SuiteB Type:** In the list, click the level of NSA Suite B encryption to use. The default is GCM-128. Possible options are:
 - **GCM-128:** Use 128-bit AES-GCM encryption.
 - **GCM-256:** Use 256-bit AES-GCM encryption.
 - **GMAC-128:** Use 128-bit AES-GMAC encryption.
 - **GMAC-256:** Use 256-bit AES-GMAC encryption.
 - **None: Use no encryption:** Type the SSL algorithm to use for client-server negotiation.
- **SSL Algorithm:** Type the SSL algorithm to use for client-server negotiation.
- **Knox:** Configurations for Samsung KNOX only.
- **Vendor:** A personal profile for generic agents that communicate with the KNOX API.
- **Forward routes:** If your corporate VPN server supports forwarding routes, for each forwarding route to use, click **Add** and do the following:
 - **Forward route:** Type the IP address for the forwarding route.
 - Click **Save** to save the route or click **Cancel** to not save the route.
- **Per App Vpn:** For each per-app VPN you want to add, click **Add** and do the following:
 - **Per App Vpn:** The VPN configuration the app uses to communicate.
 - Click **Save** to save the per-app VPN or click **Cancel** to not save the per-app VPN.

XenMobile Analyze Manage **Configure** ⚙️ 🔍 admin ▾

Device Policies Apps Actions ShareFile Delivery Groups

VPN Policy

- Policy Info
- Platforms
 - iOS
 - Mac OS X
 - Android
 - Samsung SAFE
 - Samsung KNOX
 - Windows Phone
 - Windows Tablet
 - Amazon
- Assignment

Policy Information

This policy lets you configure a VPN connection to provide a device-level encrypted connection to the intranet. For Windows Phone, the payloads are supported only on Windows 10 and later supervised devices.

Connection name*

Profile type Native ▾

VPN server name*

Tunneling protocol* L2TP ▾

Authentication method* EAP ▾

EAP method* TLS ▾

DNS suffix

Trusted networks

Require smart card certificate OFF

Automatically select client certificate OFF

Remember credential OFF

Always-on VPN OFF

Bypass For Local OFF

► **Deployment Rules**

Back Next >

Note: These settings are supported only on Windows 10 and later supervised phones.

Configure these settings:

- **Connection name:** Enter a name for the connection. This field is required.
- **Profile type:** In the list, click either **Native** or **Plugin**. The default is **Native**. The following sections describe the settings for each of these options.
- **Configure Native profile type settings** - These settings apply to the VPN built into users' Windows phones.
 - **VPN server name:** Type the FQDN or IP address for the VPN server. This field is required.
 - **Tunneling protocol:** In the list, click the type of VPN tunnel to use. The default is **L2TP**. Possible options are:
 - **L2TP:** Layer 2 Tunneling Protocol with pre-shared key authentication.
 - **PPTP:** Point-to-Point Tunneling.
 - **IKEv2:** Internet Key Exchange version 2.
 - **Authentication method:** In the list, click the authentication method to use. The default is **EAP**. Possible options are:
 - **EAP:** Extended Authentication Protocol.

- **MSChapV2:** Use Microsoft challenge-handshake authentication for mutual authentication. This option is not available when you select IKEv2 for the tunnel type. When you choose MSChapV2, an **Automatically use Windows credentials** option appears; the default is **OFF**.
- **EAP method:** In the list, click the EAP method to be used. The default is **TLS**. This field is not available when MSChapV2 authentication is enabled. Possible options are:
 - **TLS:** Transport Layer Security
 - **PEAP:** Protected Extensible Authentication Protocol
- **DNS Suffix:** Type the DNS suffix.
- **Trusted networks:** Type a list of networks separated by commas that do not require a VPN connection for access. For example, when users are on your company wireless network, they can access protected resources directly.
- **Require smart card certificate:** Select whether to require a smart card certificate. The default is **OFF**.
- **Automatically select client certificate:** Select whether to automatically choose the client certificate to use for authentication. The default is **OFF**. This option is unavailable when Require smart card certificate is enabled.
- **Remember credential:** Select whether to cache the credential. The default is **OFF**. When enabled, credentials are cached whenever possible.
- **Always on VPN:** Select whether the VPN is always on. The default is **OFF**. When enabled, the VPN connection remains on until the user manually disconnects.
- **Bypass For Local:** Type the address and port number to allow local resources to bypass the proxy server.
- **Configure Plugin protocol type** - These settings apply to VPN plug-ins obtained from the Windows Store and installed on users' devices.
 - **Server address:** Type the URL, host name, or IP address for the VPN server.
 - **Client app ID:** Type the package family name for the VPN plug-in.
 - **Plugin Profile XML:** Select the custom VPN plugin profile to be used by clicking Browse and navigating to the file's location. Contact the plugin provider for format and details.
 - **DNS Suffix:** Type the DNS suffix.
 - **Trusted networks:** Type a list of networks separated by commas that do not require a VPN connection for access. For example, when users are on your company wireless network, they can access protected resources directly.
 - **Remember credential:** Select whether to cache the credential. The default is **OFF**. When enabled, credentials are cached whenever possible.
 - **Always on VPN:** Select whether the VPN is always on. The default is **OFF**. When enabled, the VPN connection remains on until the user manually disconnects.
 - **Bypass For Local:** Type the address and port number to allow local resources to bypass the proxy server.

XenMobile Analyze Manage **Configure** ⚙️ 🔍 admin ▾

Device Policies Apps Actions ShareFile Delivery Groups

VPN Policy

- Policy Info
- Platforms
 - iOS
 - Mac OS X
 - Android
 - Samsung SAFE
 - Samsung KNOX
 - Windows Phone
 - Windows Tablet**
 - Amazon
- Assignment

Policy Information

This policy lets you configure a VPN connection to provide a device-level encrypted connection to the intranet. For Windows Phone, the payloads are supported only on Windows 10 and later supervised devices.

OS version*

Connection name*

Profile type

Server address*

Remember credential

DNS suffix

Tunnel type*

Authentication method*

EAP method*

Trusted networks

Require smart card certificate

Automatically select client certificate

Always-on VPN

Bypass For Local

► **Deployment Rules**

[Back](#) [Next >](#)

<https://web.mail.comcast.net/zimbra/mail?app=mail#1>

Configure these settings:

Configure Windows 10 settings

- **Connection name:** Enter a name for the connection. This field is required.
- **Profile type:** In the list, click either **Native** or **Plugin**. The default is **Native**.
- **Configure Native profile type** - These settings apply to the VPN built into users' Windows devices.
 - **Server address:** Type the FQDN or IP address for the VPN server. This field is required.
 - **Remember credential:** Select whether to cache the credential. The default is **OFF**. When enabled, credentials are cached whenever possible.
 - **DNS Suffix:** Type the DNS suffix.
 - **Tunnel type:** In the list, click the type of VPN tunnel to use. The default is **L2TP**. Possible options are:
 - **L2TP:** Layer 2 Tunneling Protocol with pre-shared key authentication.
 - **PPTP:** Point-to-Point Tunneling.
 - **IKEv2:** Internet Key Exchange version 2.

- **Authentication method:** In the list, click the authentication method to use. The default is **EAP**. Possible options are:
 - **EAP:** Extended Authentication Protocol.
 - **MSChapV2:** Use Microsoft's challenge-handshake authentication for mutual authentication. This option is not available when you select **IKEv2** for the tunnel type.
- **EAP method:** In the list, click the EAP method to be used. The default is **TLS**. This field is not available when **MSChapV2** authentication is enabled. Possible options are:
 - **TLS:** Transport Layer Security
 - **PEAP:** Protected Extensible Authentication Protocol
- **Trusted networks:** Type a list of networks separated by commas that do not require a VPN connection for access. For example, when users are on your company wireless network, they can access protected resources directly.
- **Require smart card certificate:** Select whether to require a smart card certificate. The default is **OFF**.
- **Automatically select client certificate:** Select whether to automatically choose the client certificate to use for authentication. The default is **OFF**. This option is unavailable when you enable **Require smart card certificate**.
- **Always on VPN:** Select whether the VPN is always on. The default is **OFF**. When enabled, the VPN connection remains on until the user manually disconnects.
- **Bypass For Local:** Type the address and port number to allow local resources to bypass the proxy server.
- **Configure Plugin profile type** - These settings apply to VPN plug-ins obtained from the Windows Store and installed on users' devices.
 - **Server address:** Type the FQDN or IP address for the VPN server. This field is required.
 - **Remember credential:** Select whether to cache the credential. The default is **OFF**. When enabled, credentials are cached whenever possible.
 - **DNS Suffix:** Type the DNS suffix.
 - **Client app ID:** Type the package family name for the VPN plug-in.
 - **Plugin Profile XML:** Select the custom VPN plugin profile to be used by clicking **Browse** and navigating to the file's location. Contact the plugin provider for format and details.
 - **Trusted networks:** Type a list of networks separated by commas that do not require a VPN connection for access. For example, when users are on your company wireless network, they can access protected resources directly.
 - **Always on VPN:** Select whether the VPN is always on. The default is **OFF**. When enabled, the VPN connection remains on until the user manually disconnects.
 - **Bypass For Local:** Type the address and port number to allow local resources to bypass the proxy server.

The screenshot shows the XenMobile configuration interface. At the top, there are tabs for 'Analyze', 'Manage', and 'Configure'. Below these are sub-tabs for 'Device Policies', 'Apps', 'Actions', 'ShareFile', and 'Delivery Groups'. The main content area is titled 'VPN Policy' and is divided into three sections: '1 Policy Info', '2 Platforms', and '3 Assignment'. Under '2 Platforms', several operating systems are listed with checkboxes: iOS, Android, Samsung SAFE, Samsung KNOX, Windows Tablet, Windows Phone, and Amazon. The 'Amazon' option is currently selected. To the right of the sidebar is the 'Policy Information' section, which includes a description: 'This policy lets you configure a VPN connection to provide a device-level encrypted connection to the intranet.' Below this description are several configuration fields: 'Connection name*' (text input), 'Vpn Type' (dropdown menu set to 'L2TP PSK'), 'Server address*' (text input), 'User name' (text input), 'Password' (text input), 'L2TP Secret' (text input), 'IPSec Identifier' (text input), 'IPSec pre-shared key' (text input), 'DNS search domains' (text input), 'DNS servers' (text input), and 'Forwarding routes' (text input). At the bottom of the configuration area, there is a 'Deployment Rules' section and two buttons: 'Back' and 'Next >'.

Configure these settings:

- **Connection name:** Enter a name for the connection.
- **Vpn type:** Click the connection type. Possible options are:
 - **L2TP PSK:** Layer 2 Tunneling Protocol with pre-shared key authentication. This is the default.
 - **L2TP RSA:** Layer 2 Tunneling Protocol with RSA authentication.
 - **IPSEC XAUTH PSK:** Internet Protocol Security with pre-shared key and extended authentication.
 - **IPSEC HYBRID RSA:** Internet Protocol Security with hybrid RSA authentication.
 - **PPTP:** Point-to-Point Tunneling.

The following sections list the configuration options for each of the preceding connection types.

Configure L2TP PSK settings

- **Server address:** Type the IP address for the VPN server.
- **User name:** Type an optional user name.
- **Password:** Type an optional password.
- **L2TP Secret:** Type the shared secret key.
- **IPSec Identifier:** Type the name of the VPN connection that users see on their devices when connecting.

- **IPSec pre-shared key:** Type the secret key.
- **DNS search domains:** Type the domains against which a user device's search domain list can match.
- **DNS servers:** Type the IP addresses of DNS servers to be used for resolving the specified domains.
- **Forwarding routes:** If your corporate VPN server supports forwarding routes, for each forwarding route to use, click **Add** and do the following:
 - **Forward route:** Type the IP address for the forwarding route.
 - Click **Save** to save the route or click **Cancel** to not save the route.

Configure L2TP RSA settings

- **Server address:** Type the IP address for the VPN server.
- **User name:** Type an optional user name.
- **Password:** Type an optional password.
- **L2TP Secret:** Type the shared secret key.
- **DNS search domains:** Type the domains against which a user device's search domain list can match.
- **DNS servers:** Type the IP addresses of DNS servers to be used for resolving the specified domains.
- **Server certificate:** In the list, click the server certificate to be used.
- **CA certificate:** In the list, click the CA certificate to be used.
- **Identity credential:** In the list, click the identity credential to be used.
- **Forwarding routes:** If your corporate VPN server supports forwarding routes, for each forwarding route to use, click **Add** and do the following:
 - **Forward route:** Type the IP address for the forwarding route.
 - Click **Save** to save the route or click **Cancel** to not save the route.

Configure IPSEC XAUTH PSK settings

- **Server address:** Type the IP address for the VPN server.
- **User name:** Type an optional user name.
- **Password:** Type an optional password.
- **IPSec Identifier:** Type the name of the VPN connection that users see on their devices when connecting.
- **IPSec pre-shared key:** Type the shared secret key.
- **DNS search domains:** Type the domains against which a user device's search domain list can match.
- **DNS servers:** Type the IP addresses of DNS servers to be used for resolving the specified domains.
- **Forwarding routes:** If your corporate VPN server supports forwarding routes, for each forwarding route to use, click **Add** and do the following:
 - **Forward route:** Type the IP address for the forwarding route.
 - Click **Save** to save the route or click **Cancel** to not save the route.

Configure IPSEC AUTH RSA settings

- **Server address:** Type the IP address for the VPN server.
- **User name:** Type an optional user name.
- **Password:** Type an optional password.
- **DNS search domains:** Type the domains against which a user device's search domain list can match.
- **DNS servers:** Type the IP addresses of DNS servers to be used for resolving the specified domains.
- **Server certificate:** In the list, click the server certificate to be used.
- **CA certificate:** In the list, click the CA certificate to be useg.
- **Identity credential:** In the list, click the identity credential to be useg.

- **Forwarding routes:** If your corporate VPN server supports forwarding routes, for each forwarding route to use, click **Add** and do the following:
 - **Forward route:** Type the IP address for the forwarding route.
 - Click **Save** to save the route or click **Cancel** to not save the route.

Configure IPSEC HYBRID RSA settings

- **Server address:** Type the IP address for the VPN server.
- **User name:** Type an optional user name.
- **Password:** Type an optional password.
- **DNS search domains:** Type the domains against which a user device's search domain list can match.
- **DNS servers:** Type the IP addresses of DNS servers to be used for resolving the specified domains.
- **Server certificate:** In the list, click the server certificate to be used.
- **CA certificate:** In the list, click the CA certificate to be used.
- **Forwarding routes:** If your corporate VPN server supports forwarding routes, for each forwarding route to use, click **Add** and do the following:
 - **Forward route:** Type the IP address for the forwarding route.
 - Click **Save** to save the route or click **Cancel** to not save the route.

Configure PPTP settings

- **Server address:** Type the IP address for the VPN server.
- **User name:** Type an optional user name.
- **Password:** Type an optional password.
- **DNS search domains:** Type the domains against which a user device's search domain list can match.
- **DNS servers:** Type the IP addresses of DNS servers to be used for resolving the specified domains.
- **PPP encryption (MPPE):** Select whether to enable data encryption with Microsoft Point-to-Point Encryption (MPPE). The default is **OFF**.
- **Forwarding routes:** If your corporate VPN server supports forwarding routes, for each forwarding route to use, click **Add** and do the following:
 - **Forward route:** Type the IP address for the forwarding route.
 - Click **Save** to save the route or click **Cancel** to not save the route.

7. Configure deployment rules and choose delivery groups. For more information, see [Add a device policy](#).

Wallpaper device policy

Jun 19, 2017

You can add a .png or .jpg file to set wallpaper on an iOS device lock screen, home screen, or both. Available in iOS 7.1.2 and later. To use different wallpaper on iPads and iPhones, you need to create different wallpaper policies and deploy them to the appropriate users.

The following table lists Apple's recommended image dimensions for iOS devices.

Device		Image dimensions in pixels
iPhone	iPad	
4, 4s		640 x 960
5, 5c, 5s		640 x 1136
6, 6s		750 x 1334
6 Plus		1080 x 1920
	Air, 2	1536 x 2048
	4, 3	1536 x 2048
	Mini 2, 3	1536 x 2048
	Mini	768 x 1024

1. In the XenMobile console, click **Configure > Device Policies**. The **Device Policies** page appears.
2. Click **Add**. The **Add a New Policy** dialog box appears.
3. Expand **More** and then, under **End User**, click **Wallpaper**. The **Wallpaper Policy** page appears.

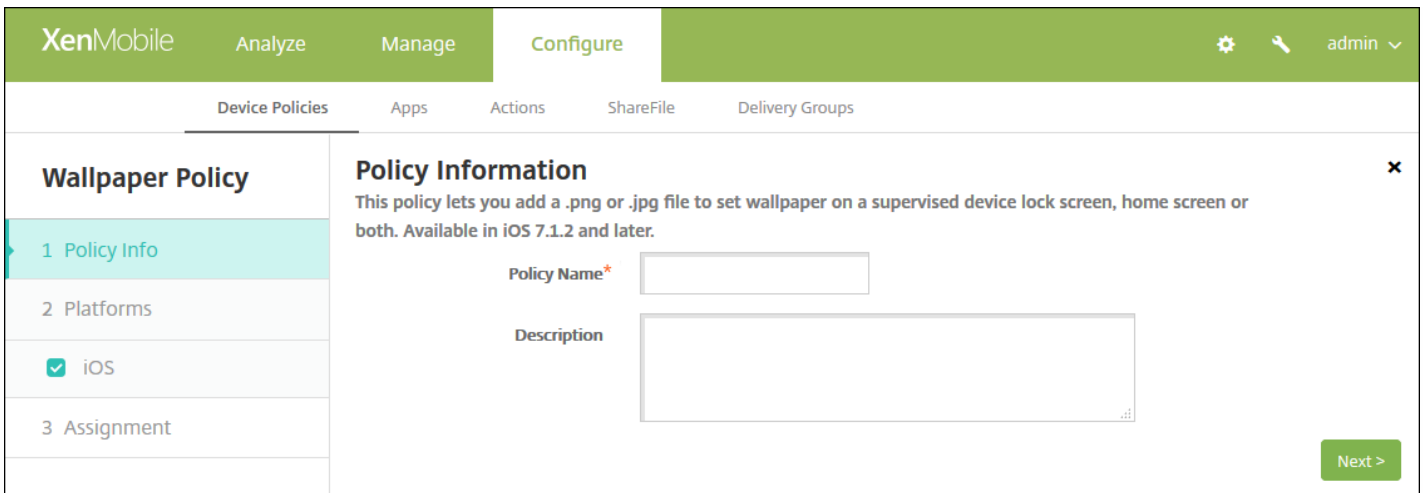

4. In the **Policy Information** pane, enter the following information:

- **Policy Name:** Type a descriptive name for the policy.
- **Description:** Type an optional description of the policy.

5. Click **Next**. The **Policy Platforms** page appears.

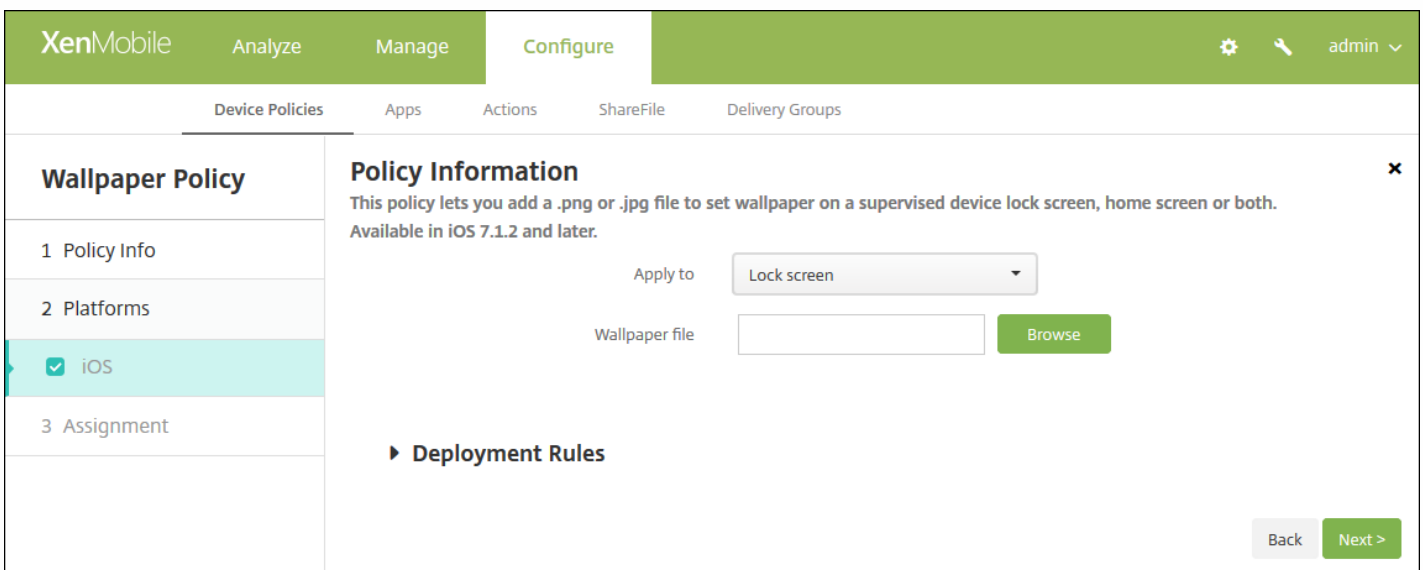

Configure these settings:

- **Apply to:** In the list, select **Lock screen**, **Home (icon list) screen**, or **Lock and home screens** to set where the wallpaper is to appear.
- **Wallpaper file:** Select the wallpaper file by clicking **Browse** and navigating to the file's location.

7. Configure deployment rules and choose delivery groups. For more information, see [Add a device policy](#).

Web content filter device policy

Jun 28, 2017

You can add a device policy in XenMobile to filter web content on iOS devices by using Apple's auto-filter function in conjunction with specific sites that you add to whitelists and blacklists. This policy is available only on iOS 7.0 and later devices in Supervised mode. For information about placing an iOS device into Supervised mode, see [To place an iOS device in Supervised mode by using the Apple Configurator](#).

1. In the XenMobile console, click **Configure > Device Policies**. The **Device Policies** page appears.
2. Click **Add**. The **Add a New Policy** dialog box appears.
3. Click **More** and then, under **Security**, click **Web Content Filter**. The **Web Content Filter Policy** page appears.
4. In the **Policy Information** pane, enter the following information:
 - **Policy Name:** Type a descriptive name for the policy.
 - **Description:** Optionally, type a description of the policy.
5. Click **Next**. The **iOS Platform** information page appears.

The screenshot shows the XenMobile console interface. The top navigation bar includes 'XenMobile', 'Analyze', 'Manage', and 'Configure'. The 'Configure' tab is active, and the 'Device Policies' sub-tab is selected. The main content area is titled 'Web Content Filter Policy' and 'Policy Information'. The 'Policy Information' section includes a description: 'This policy lets you whitelist and blacklist specific URLs. The policy is supported only on iOS 7 and later supervised devices.' The 'Web Content Filter' section has a 'Filter type' dropdown set to 'Built-in' and an 'Auto filter enabled' toggle set to 'OFF'. Below this are sections for 'Permitted URLs' and 'Blacklisted URLs', each with an 'Add' button. The 'Bookmark Whitelist' section has a table with columns for 'URL*', 'Bookmark Folder', and 'Title*', and an 'Add' button. The 'Policy Settings' section has a 'Remove policy' section with radio buttons for 'Select date' (selected) and 'Duration until removal (in days)', and a date picker. There is also an 'Allow user to remove policy' dropdown set to 'Always'. At the bottom right, there are 'Back' and 'Next >' buttons.

6. Configure these settings:

- **Filter type:** In the list, click either **Built-in** or **Plug-in**, and then follow the procedures that follow for the option you choose. The default is **Built-in**.

Built-in filter type settings

- **Web Content Filter**
 - **Auto filter enabled:** Select whether to use Apple's auto-filter function to analyze websites for inappropriate content. The default is **OFF**.
 - **Permitted URLs:** This list is ignored when **Auto filter enabled** is set to **OFF**. When **Auto filter enabled** is set to **ON**, the items in this list are always accessible regardless of whether the auto filter allows access. For each URL you want to add to the whitelist, click **Add** and do the following:
 - Type the URL of the permitted website. You must add **http://** or **https://** before the web address.
 - Click **Save** to save the website to the whitelist or click **Cancel** not to save it.
 - **Blacklisted URLs:** Items in this list are always blocked. For each URL you want to add to the blacklist, click **Add** and do the following:
 - Enter the URL of the website to be blocked. You must add **http://** or **https://** before the web address.
 - Click **Save** to save the website to the blacklist or click **Cancel** not to save it.
- **Bookmark whitelist**
 - **Bookmark Whitelist:** Items in this list are the only sites accessible to users. For each web site you want to add to the bookmark whitelist, click **Add** and do the following:
 - **URL:** Type the URL of the website to be bookmarked. You must add **http://** or **https://** before the web address. This field is required.
 - **Bookmark folder:** Enter an optional bookmark folder name. If this field is left blank, the bookmark is added to the default bookmarks directory.
 - **Title:** Enter a descriptive title for the website. For example, type "Google" for the URL **http://google.com**.
 - Click **Save** to save the website to the blacklist or click **Cancel** not to save it.

Note: To delete an existing website, hover over the line containing the listing and then click the trash can icon on the right-hand side. A confirmation dialog box appears. Click **Delete** to delete the listing or **Cancel** to keep the listing.

To edit an existing website, hover over the line containing the listing and then click the pen icon on the right-hand side. Make any changes to the listing and then click **Save** to save the changed listing or **Cancel** to leave the listing unchanged.

Plug-in filter type settings

- **Filter name:** Enter a unique name for the filter.
- **Identifier:** Enter the bundle ID of the plugin that provides the filtering service.
- **Service address:** Enter an optional server address. Valid formats are IP address, host name, or URL.
- **User name:** Enter an optional user name for the service.
- **Password:** Enter an optional password for the service.
- **Certificate:** In the list, click an optional identity certificate to be used to authenticate the user to the service. The default is **None**.
- **Filter WebKit traffic:** Select whether to filter WebKit traffic.
- **Filter Socket traffic:** Select whether to filter socket traffic.
- **Custom Data:** For each custom key you want to add to the web filter, click **Add** and then do the following:
 - **Key:** Type the custom key.

- **Value:** Type a value for the custom key.
- Click **Save** to save the custom key or click **Cancel** not to save it.

Note: To delete an existing key, hover over the line containing the listing and then click the trash can icon on the right-hand side. A confirmation dialog box appears. Click **Delete** to delete the listing or **Cancel** to keep the listing.

To edit an existing key, hover over the line containing the listing and then click the pen icon on the right-hand side. Make any changes to the listing and then click **Save** to save the changed listing or **Cancel** to leave the listing unchanged.

Policy Settings

- Next to **Remove policy**, click either **Select date** or **Duration until removal (in hours)**.
- If you click **Select date**, click the calendar to select the specific date for removal.
- In the **Allow user to remove policy** list, click **Always**, **Password required**, or **Never**.
- If you click **Password required**, next to **Removal password**, type the necessary password.

7. Configure deployment rules and choose delivery groups. For more information, see [Add a device policy](#).

Webclip device policy

Jun 19, 2017

You can place shortcuts, or webclips, to websites to appear alongside apps on users' devices. You can specify your own icons to represent the webclips for iOS, Mac OS X, and Android devices; Windows tablet only requires a label and a URL.

[iOS settings](#)

[Mac OS X settings](#)

[Android settings](#)

[Windows Desktop/Tablet settings](#)

1. In the XenMobile console, click **Configure > Device Policies**. The **Device Policies** page appears.
 2. Click **Add**. The **Add a New Policy** dialog box appears.
 3. Expand **More** and then, under **Apps**, click **Webclip**. The **Webclip Policy** page appears.
 4. In the **Policy Information** pane, enter the following information:
 - **Policy Name**: Type a descriptive name for the policy.
 - **Description**: Type an optional description of the policy.
 5. Click **Next**. The **Policy Platforms** page appears.
 6. Under **Platforms**, select the platforms you want to add. If you are only configuring for one platform, clear the others.
- When you finish configuring the settings for a platform, refer to Step 7 for how to set that platform's deployment rules.

XenMobile Analyze Manage **Configure**

Device Policies Apps Actions ShareFile Enrollment Profiles Delivery Groups

Webclip Policy

This policy lets you place shortcuts, or webclips, to websites to appear alongside apps on devices.

1 Policy Info

2 Platforms

- iOS
- Mac OS X
- Android
- Windows Desktop/Tablet

3 Assignment

Webclip Policy

Label*

URL* ?

Removable OFF

Icon to be updated **Browse**

Precomposed icon OFF

Full screen OFF

Policy Settings

Remove policy

- Select date
- Duration until removal (in days)

Allow user to remove policy ?

Configure these settings:

- **Label:** Type the label that is to appear with the webclip.
- **URL:** Type the URL associated with the webclip. The URL must begin with a protocol, for example, http://server.
- **Removable:** Select whether users can remove the webclip. The default is **OFF**.
- **Icon to be updated:** Select the icon to be used for the webclip by clicking **Browse** and navigating to the file's location.
- **Precomposed icon:** Select whether the icon has effects (rounded corners, drop shadow, and reflective shine) applied to it. The default is **OFF**, which adds the effects.
- **Full screen:** Select whether the linked web page opens in full-screen mode. The default is **OFF**.
- **Policy Settings**
 - Next to **Remove policy**, click either **Select date** or **Duration until removal (in hours)**.
 - If you click **Select date**, click the calendar to select the specific date for removal.
 - In the **Allow user to remove policy** list, click **Always**, **Password required**, or **Never**.
 - If you click **Password required**, next to **Removal password**, type the necessary password.

XenMobile Analyze Manage **Configure**

Device Policies Apps Actions ShareFile Enrollment Profiles Delivery Groups

Webclip Policy

This policy lets you place shortcuts, or webclips, to websites to appear alongside apps on devices.

1 Policy Info

2 Platforms

iOS

Mac OS X

Android

Windows Desktop/Tablet

3 Assignment

Label*

URL* ⓘ

Icon to be updated **Browse**

Policy Settings

Remove policy Select date Duration until removal (in days)

ⓘ

Allow user to remove policy ⓘ

► **Deployment Rules**

Configure these settings:

- **Label:** Type the label that is to appear with the webclip.
- **URL:** Type the URL associated with the webclip. The URL must begin with a protocol, for example, http://server.
- **Icon to be updated:** Select the icon to be used for the webclip by clicking Browse and navigating to the file's location.
- **Policy Settings**
 - Next to **Remove policy**, click either **Select date** or **Duration until removal (in hours)**.
 - If you click **Select date**, click the calendar to select the specific date for removal.
 - In the **Allow user to remove policy** list, click **Always**, **Password required**, or **Never**.
 - If you click **Password required**, next to **Removal password**, type the necessary password.
 - In the **Profile scope** list, click **User** or **System**. This option is available on OS X 10.7 and later.

XenMobile Analyze Manage **Configure**

Device Policies Apps Actions ShareFile Enrollment Profiles Delivery Groups

Webclip Policy

This policy lets you place shortcuts, or webclips, to websites to appear alongside apps on devices.

1 Policy Info

2 Platforms

iOS

Mac OS X

Android

Windows Desktop/Tablet

3 Assignment

Rule Add Remove

Label*

URL*

Define an icon OFF

► **Deployment Rules**

Configure these settings:

- **Rule:** Select whether this policy adds or removes a webclip. The default is **Add**.
- **Label:** Type the label that is to appear with the webclip.
- **URL:** Type the URL associated with the webclip.
- **Define an icon:** Select whether to use an icon file. The default is **OFF**.
- **Icon file:** If **Define an icon** is **ON**, select the icon file to use by clicking **Browse** and navigating to the file's location.

XenMobile Analyze Manage **Configure**

Device Policies Apps Actions ShareFile Enrollment Profiles Delivery Groups

Webclip Policy

This policy lets you place shortcuts, or webclips, to websites to appear alongside apps on devices.

1 Policy Info

2 Platforms

iOS

Mac OS X

Android

Windows Desktop/Tablet

3 Assignment

Name*

URL*

► **Deployment Rules**

Configure these settings:

- **Name:** Type the label that is to appear with the webclip.
- **URL:** Type the URL associated with the webclip.

7. Configure deployment rules and choose delivery groups. For more information, see [Add a device policy](#).

8. Click **Next**. The **Webclip Policy** assignment page appears.

XenMobile Analyze Manage **Configure**

Device Policies Apps Actions ShareFile Enrollment Profiles Delivery Groups

Webclip Policy

This policy lets you place shortcuts, or webclips, to websites to appear alongside apps on devices.

Choose delivery groups

- AllUsers
- DG- [redacted]
- DG- [redacted]

► **Deployment Schedule**

9. Next to **Choose delivery groups**, type to find a delivery group or select a group or groups in the list to which you want to assign the policy. The groups you select appear in the **Delivery groups to receive app assignment** list.

10. Expand **Deployment Schedule** and then configure the following settings:

- Next to **Deploy**, click **ON** to schedule deployment or click **OFF** to prevent deployment. The default option is **ON**. If you choose **OFF**, no other options need to be configured.
- Next to **Deployment schedule**, click **Now** or **Later**. The default option is **Now**.
- If you click **Later**, click the calendar icon and then select the date and time for deployment.
- Next to **Deployment condition**, click **On every connection** or click **Only when previous deployment has failed**. The default option is **On every connection**.
- Next to **Deploy for always-on connection**, click **ON** or **OFF**. The default option is **OFF**.

Note:

- This option applies when you have configured the scheduling background deployment key in **Settings > Server**

Properties. The always-on option is not available for iOS devices.

- The deployment schedule you configure is the same for all platforms. Any changes you make apply to all platforms, except for **Deploy for always on connection**, which does not apply

11. Click **Save** to save the policy.

WiFi device policy

Jul 06, 2017

You create new or edit existing WiFi device policies in XenMobile by using the **Configure > Device Policies** page. WiFi policies let you manage how users connect their devices to WiFi networks by defining the following items:

- Network names and types
- Authentication and security policies
- Proxy server use
- Other WiFi-related details

You can configure WiFi settings for users for the following platforms. Each platform requires a different set of values, which are described in detail in this article.

[iOS settings](#)

[Mac OS X settings](#)

[Android settings](#) (includes devices enabled for Android for Work)

[Windows Phone settings](#)

[Windows Desktop/Tablet settings](#)

Important

Before you create a policy, be sure that you complete these steps:

- Create any delivery groups that you plan to use.
- Know the network name and type.
- Know any authentication or security types that you plan to use.
- Know any proxy server information that you might need.
- Install any necessary CA certificates.
- Have any necessary shared keys.
- Create the PKI entity for certificate-based authentication.
- Configure credential providers.

For more information, see [Authentication](#) and its subarticles.

1. In the XenMobile console, click **Configure > Device Policies**. The **Device Policies** page appears.
2. Click **Add**. The **Add a New Policy** dialog box appears.
3. Click **WiFi**. The **WiFi Policy** page appears.
4. In the **Policy Information** pane, type the following information:
 - **Policy Name:** Type a descriptive name for the policy.
 - **Description:** Optionally, type a description of the policy.

5. Click **Next**. The **Platforms** page appears.

6. Under **Platforms**, select the platforms you want to add. If you are only configuring for one platform, clear the others.

When you finish configuring the settings for a platform, refer to Step 7 to set deployment rules for that platform.

XenMobile Analyze Manage **Configure** ⚙️ 🔍 admin ▾

Device Policies Apps Actions ShareFile Enrollment Profiles Delivery Groups

WiFi Policy

This policy lets you configure a WiFi profile for devices.

1 Policy Info

2 Platforms

- iOS
- Mac OS X
- Android
- Windows Phone
- Windows Desktop/Tablet
- Windows Mobile/CE

3 Assignment

WiFi Policy

Network type: Standard

Network name*:

Hidden network (enable if network is open or off): OFF

Auto join (automatically join this wireless network): ON

Security type: None

Proxy server settings: Proxy configuration: None

Policy Settings

Remove policy: Select date Duration until removal (in days)

Allow user to remove policy: Always

► Deployment Rules

Back Next >

Configure these settings:

- **Network type:** In the list, choose **Standard**, **Legacy Hotspot**, or **Hotspot 2.0** to set the network type you plan to use.
- **Network Name:** Type the SSID that is seen in the list of available networks for the device. Does not apply to **Hotspot 2.0**.
- **Hidden network (enable if network is open or off):** Choose whether the network is hidden.
- **Auto Join (automatically join this wireless network):** Choose whether the network is joined automatically. The default is **ON**.
- **Security type:** In the list, choose the security type you plan to use. Does not apply to **Hotspot 2.0**.
 - None - Requires no further configuration.
 - WEP
 - WPA/WPA2 Personal
 - Any (Personal)
 - WEP Enterprise
 - WPA/WPA2 Enterprise: For the latest release of Windows 10, use of WPA-2 Enterprise requires that you configure SCEP. XenMobile can then send the certificate to devices to authenticate to the WiFi server. To configure SCEP, go

to Distribution page of **Settings > Credential Providers**. For more information, see [Credential providers](#).

- Any (Enterprise)

The following sections list the options you configure for each of the preceding connection types.

WPA, WPA Personal, Any (Personal)

Password: Type an optional password. If you leave this field blank, users might be prompted for their passwords when they log on.

WEP Enterprise, WPA Enterprise, WPA2 Enterprise, Any (Enterprise)

Note: When you choose any of these settings, their settings are listed after **Proxy server settings**.

- **Protocols, accepted EAP types:** Enable the EAP types you want to support and then configure the associated settings. The default is **OFF** for each of the available EAP type.
- **Inner authentication (TTLS):** *Required only when you enable TTLS.* In the list, choose the inner authentication method to use. Options are: **PAP**, **CHAP**, **MSCHAP**, or **MSCHAPv2**. The default is **MSCHAPv2**.
- **Protocols, EAP-FAST:** Choose whether to use protected access credentials (PACs).
 - If you choose **Use PAC**, choose whether to use a provisioning PAC.
 - If you choose **Provisioning PAC**, choose whether to allow an anonymous TLS handshake between the end-user client and XenMobile.
 - **Provisioning PAC anonymously**
- **Authentication:**
 - **User name:** Type a user name.
 - **Per-connection password:** Choose whether to require a password each time that users log on.
 - **Password:** Type an optional password. If you leave this field blank, users might be prompted for their passwords when they log on.
 - **Identity credential (Keystore or PKI credential):** In the list, choose the type of identity credential. The default is **None**.
 - **Outer identity:** *Required only when you enable PEAP, TTLS, or EAP-FAST.* Type the externally visible user name. You can increase security by typing a generic term such as "anonymous" so that the user name isn't visible.
 - **Require a TLS certificate:** Choose whether to require a TLS certificate.
- **Trust**
 - **Trusted certificates:** To add a trusted certificate, click **Add** and, for each certificate you want to add, do the following:
 - **Application:** In the list, choose the application you want to add.
 - Click **Save** to save the certificate or click **Cancel**.
 - **Trusted server certificate names:** To add trusted server certificate common names, click **Add** and, for each name you want to add, do the following:
 - **Certificate:** Type the name of the server certificate. You can use wildcards to specify the name, such as `wpa.*.example.com`.
 - Click **Save** to save the certificate name or click **Cancel**.

To delete an item, hover over the line containing the listing and click the trash icon on the right side. A confirmation dialog box appears. Click **Delete** to delete the listing or **Cancel** to keep the listing.

To edit an item, hover over the line containing the listing and click the pen icon on the right side. Update the listing and then click **Save**.

- **Allow trust exceptions:** Choose whether the certificate trust dialog appears on users devices when a certificate is untrusted. The default is **ON**.

- **Proxy server settings**

- **Proxy configuration:** In the list, choose **None**, **Manual**, or **Automatic** to set how the VPN connection routes through a proxy server and then configure any additional options. The default is **None**, which requires no further configuration.
- If you choose **Manual**, configure these settings:
 - **Hostname/IP address:** Type the host name or IP address of the proxy server.
 - **Port:** Type the proxy server port number.
 - **User name:** Type an optional user name to authenticate to the proxy server.
 - **Password:** Type an optional password to authenticate to the proxy server.
- If you choose **Automatic**, configure these settings:
 - **Server URL:** Type URL of the PAC file that defines the proxy configuration.
 - **Allow direct connection if PAC is unreachable:** Choose whether to allow users to connect directly to the destination if the PAC file is unreachable. The default is **ON**. This option is available only on iOS 7.0 and later.

- **Policy Settings**

- Next to **Remove policy**, choose either **Select date** or **Duration until removal (in hours)**.
- If you choose **Select date**, click the calendar to choose the specific date for removal.
- In the **Allow user to remove policy** list, choose **Always**, **Password required**, or **Never**.
- If you choose **Password required**, next to **Removal password**, type the necessary password.

Configure these settings:

- **Network type:** In the list, choose **Standard**, **Legacy Hotspot**, or **Hotspot 2.0** to set the network type you plan to use.
- **Network Name:** Type the SSID that is seen in the list of available networks for the device. Does not apply to **Hotspot 2.0**.
- **Hidden network (enable if network is open or off):** Choose whether the network is hidden.
- **Auto Join (automatically join this wireless network):** Choose whether the network is joined automatically. The default is **ON**.
- **Security type:** In the list, choose the security type you plan to use. Does not apply to **Hotspot 2.0**.
 - None - Requires no further configuration.
 - WEP
 - WPA/WPA2 Personal
 - Any (Personal)
 - WEP Enterprise
 - WPA/WPA2 Enterprise
 - Any (Enterprise)

The following sections list the options you configure for each of the preceding connection types.

WPA, WPA Personal, WPA 2 Personal, Any (Personal)

- **Password:** Type an optional password. If you leave this field blank, users might be prompted for their passwords when they log on.

WEP Enterprise, WPA Enterprise, WPA2 Enterprise, Any (Enterprise)

Note: When you choose any of these settings, their settings are listed after **Proxy server settings**.

- **Protocols, accepted EAP types:** Enable the EAP types you want to support and then configure the associated settings. The default is **OFF** for each of the available EAP type.
- **Inner authentication (TTLS):** *Required only when you enable TTLS.* In the list, choose the inner authentication method to use. Options are: **PAP**, **CHAP**, **MSCHAP**, or **MSCHAPv2**. The default is **MSCHAPv2**.
- **Protocols, EAP-FAST:** Choose whether to use protected access credentials (PACs).
 - If you select **Use PAC**, choose whether to use a provisioning PAC.
 - If you choose **Provisioning PAC**, choose whether to allow an anonymous TLS handshake between the end-user client and XenMobile.
 - **Provisioning PAC anonymously**
- **Authentication:**
 - **User name:** Type a user name.
 - **Per-connection password:** Choose whether to require a password each time users log on.
 - **Password:** Type an optional password. If you leave this field blank, users might be prompted for their passwords when they log on.
 - **Identity credential (Keystore or PKI credential):** In the list, choose the type of identity credential. The default is **None**.
 - **Outer identity:** *Required only when you enable PEAP, TTLS, or EAP-FAST.* Type the externally visible user name. You can increase security by typing a generic term like "anonymous" so that the user name isn't visible.
 - **Require a TLS certificate:** Choose whether to require a TLS certificate.
- **Trust**
 - **Trusted certificates:** To add a trusted certificate, click **Add** and, for each certificate you want to add, do the following:
 - **Application:** In the list, choose the application you want to add.
 - Click **Save** to save the certificate or click **Cancel**.
 - **Trusted server certificate names:** To add trusted server certificate common names, click **Add** and, for each name you want to add, do the following:

- **Certificate:** Type the name of the server certificate you want to add. You can use wildcards to specify the name, such as wpa.*.example.com.
- Click **Save** to save the certificate name or click **Cancel**.

To delete an item, hover over the line containing the listing and click the trash icon on the right side. A confirmation dialog box appears. Click **Delete** to delete the listing or **Cancel** to keep the listing.

To edit an item, hover over the line containing the listing and click the pen icon on the right side. Update the listing and then click **Save**.

- **Allow trust exceptions:** Choose whether the certificate trust dialog appears on user devices when a certificate is untrusted. The default is **ON**.

Use as a Login Window configuration: Choose whether to use the same credentials entered at the login window to • authenticate the user.

- **Proxy server settings**

- **Proxy configuration:** In the list, choose **None**, **Manual**, or **Automatic** to set how the VPN connection routes through a proxy server and then configure any additional options. The default is **None**, which requires no further configuration.
- If you choose **Manual**, configure these settings:
 - **Hostname/IP address:** Type the host name or IP address of the proxy server.
 - **Port:** Type the proxy server port number.
 - **User name:** Type an optional user name to authenticate to the proxy server.
 - **Password:** Type an optional password to authenticate to the proxy server.
- If you choose **Automatic**, configure these settings:
 - **Server URL:** Type URL of the PAC file that defines the proxy configuration.
 - **Allow direct connection if PAC is unreachable:** Choose whether to allow users to connect directly to the destination if the PAC file is unreachable. The default is **ON**. This option is available only on iOS 7.0 and later.

- **Policy Settings**

- Next to **Remove policy**, choose either **Select date** or **Duration until removal (in hours)**.
- If you choose **Select date**, click the calendar to choose the specific date for removal.
- In the **Allow user to remove policy** list, choose **Always**, **Password required**, or **Never**.
- If you choose **Password required**, next to **Removal password**, type the necessary password.
- Next to **Profile scope**, choose either **User** or **System**. The default is **User**. This option is available only for OS X 10.7 and later.

The screenshot shows the XenMobile configuration interface. At the top, there are navigation tabs: XenMobile, Analyze, Manage, and Configure. Below these are sub-tabs: Device Policies, Apps, Actions, ShareFile, Enrollment Profiles, and Delivery Groups. The main content area is titled 'WiFi Policy' and includes a sidebar with sections: 1 Policy Info, 2 Platforms, and 3 Assignment. Under '2 Platforms', several operating systems are listed with checkboxes: iOS, Mac OS X, Android (highlighted), Windows Phone, Windows Desktop/Tablet, and Windows Mobile/CE. The main configuration area contains the following fields:

- Network name***: A text input field with an information icon.
- Authentication**: A dropdown menu currently set to 'Open'.
- Encryption**: A dropdown menu currently set to 'WEP'.
- Password***: A text input field.
- Hidden network (enable if network is open or off)**: A toggle switch currently set to 'OFF'.
- Deployment Rules**: A section header with a right-pointing arrow.

At the bottom right of the configuration area, there are 'Back' and 'Next >' buttons.

Configure these settings:

- **Network name:** Type the SSID that is in the list of available networks on the user device.
- **Authentication:** In the list, choose the type of security to use with the WiFi connection.
 - Open
 - Shared
 - WPA
 - WPA-PSK
 - WPA2
 - WPA2-PSK
 - 802.1x EAP

The following sections list the options you configure for each of the preceding connection types.

Open, Shared

- **Encryption:** In the list, choose either **Disabled** or **WEP**. The default is **WEP**.
- **Password:** Type an optional password.

WPA, WPA-PSK, WPA2, WPA2-PSK

- **Encryption:** In the list, choose either TKIP or AES. The default is TKIP.
- **Password:** Type an optional password.

802.1x

- **EAP Type:** In the list, choose PEAP, TLS, or TTLS. The default is PEAP.
- **Password:** Type an optional password.
- **Authentication phase 2:** In the list, choose None, PAP, MSCHAP, MSCHAPPv2, or GTC. The default is PAP.
- **Identity:** Type the optional user name and domain.
- **Anonymous:** Type the optional, externally visible user name. You can increase security by typing a generic term like "anonymous" so that the user name isn't visible.
- **CA certificate:** In the list, choose the certificate to use.
- **Identity credential:** In the list, choose the identity credential to use. The default is None.

Hidden network (Enable if network is open or off): Choose whether the network is hidden. ●

The screenshot shows the XenMobile configuration interface. The top navigation bar includes 'XenMobile', 'Analyze', 'Manage', and 'Configure'. Below this, there are tabs for 'Device Policies', 'Apps', 'Actions', 'ShareFile', 'Enrollment Profiles', and 'Delivery Groups'. The main content area is titled 'WiFi Policy' and includes a sub-header 'WiFi Policy' with a description: 'This policy lets you configure a WiFi profile for devices.' On the left, a sidebar lists policy sections: '1 Policy Info', '2 Platforms', and '3 Assignment'. Under '2 Platforms', several operating systems are listed with checkboxes: iOS, Mac OS X, Android, Windows Phone (checked), Windows Desktop/Tablet (checked), and Windows Mobile/CE. The '3 Assignment' section is currently empty. The main configuration area on the right contains the following settings:

- Network name***: WiFi_24G
- Authentication**: WPA-2 Enterprise
- Encryption**: AES
- EAP Type**: TLS
- Connect if hidden**: OFF
- Connect automatically**: ON
- Push certificate via SCEP**: ON
- Credential provider for SCEP***: certsrv-cpwifi
- Proxy server settings**:
 - Host name or IP address**: [Empty text box]
 - Port**: [Empty text box]

Configure these settings:

- **Network name:** Type the SSID that is in the list of available networks on the user device.
- **Authentication:** In the list, choose the type of security to use with the WiFi connection.
 - Open
 - WPA Personal
 - WPA-2 Personal
 - WPA-2 Enterprise: For the latest release of Windows 10, use of WPA-2 Enterprise requires that you configure SCEP. SCEP configuration enables XenMobile to send the certificate to devices to authenticate to the WiFi server. To configure SCEP, go to **Distribution** page of **Settings > Credential Providers**. For more information, see [Credential providers](#).

The following sections list the options you configure for each of the preceding connection types.

Open

- **Connect if hidden:** Choose whether to connect when the network is hidden.
- **Connect automatically:** Choose whether to connect to the network automatically.

WPA Personal, WPA-2 Personal

- **Encryption:** In the list, choose either **AES** or **TKIP** to set the type of encryption. The default is **AES**.
- **Connect if hidden:** Choose whether to connect when the network is hidden.
- **Connect automatically:** Choose whether to connect to the network automatically.

WPA-2 Enterprise

- **Encryption:** In the list, choose either **AES** or **TKIP** to set the type of encryption. The default is **AES**.
- **EAP Type:** in the list, choose either **PEAP-MSCHAPv2** or **TLS** to set the EAP type. The default is **PEAP-MSCHAPv2**.
- **Connect if hidden:** Choose whether to connect when the network is hidden.
- **Connect automatically:** Choose whether to connect to the network automatically.
- **Push certificate via SCEP:** Choose whether to push the certificate to user devices via Simple Certificate Enrollment Protocol (SCEP).
- **Credential provider for SCEP:** In the list, choose the SCEP credential provider. The default is **None**.

Proxy server settings

- **Host name or IP address:** Type the name or IP address of the proxy server.
- **Port:** Type the port number for the proxy server.

XenMobile Analyze Manage **Configure**

Device Policies Apps Actions ShareFile Enrollment Profiles Delivery Groups

WiFi Policy

This policy lets you configure a WiFi profile for devices.

1 Policy Info

2 Platforms

- iOS
- Mac OS X
- Android
- Windows Phone
- Windows Desktop/Tablet
- Windows Mobile/CE

3 Assignment

OS version* 10

Network name* WiFi_24G ⓘ

Authentication WPA-2 Enterprise

Encryption AES

EAP Type PEAP-MSCHAPv2

Hidden network (enable if network is open or off) OFF

Connect automatically ON

Enable SCEP? ON

Credential provider for SCEP* certsrv-cpwifi

Proxy server settings

Host name or IP address

Port

Configure the following settings:

Windows 10 settings

- **Authentication:** In the list, click the type of security to use with the WiFi connection.
 - Open
 - WPA Personal
 - WPA-2 Personal
 - WPA Enterprise
 - WPA-2 Enterprise: For the latest release of Windows 10, use of WPA-2 Enterprise requires that you configure SCEP. SCEP configuration enables XenMobile to send the certificate to devices to authenticate to the WiFi server. To configure SCEP, go to **Distribution** page of **Settings > Credential Providers**. For more information, see [Credential providers](#).

The following sections list the options you configure for each of the preceding connection types.

Open

- **Hidden network (Enable if network is open or off):** Choose whether the network is hidden.
- **Connect automatically:** Choose whether to connect to the network automatically.

WPA Personal, WPA-2 Personal

- **Encryption:** In the list, choose either **AES** or **TKIP** to set the type of encryption. The default is **AES**.
- **Hidden network (Enable if network is open or off):** Choose whether the network is hidden.
- **Connect automatically:** Choose whether to connect to the network automatically.

WPA-2 Enterprise

- **Encryption:** In the list, choose either **AES** or **TKIP** to set the type of encryption. The default is **AES**.
- **EAP Type:** in the list, choose either **PEAP-MSCHAPv2** or **TLS** to set the EAP type. The default is **PEAP-MSCHAPv2**.
- **Connect if hidden:** Choose whether the network is hidden.
- **Connect automatically:** Choose whether to connect to the network automatically.
- **Push certificate via SCEP:** Choose whether to push the certificate to user devices by using Simple Certificate Enrollment Protocol (SCEP).
- **Credential provider for SCEP:** In the list, choose the SCEP credential provider. The default is **None**.

The screenshot shows the XenMobile configuration interface for a WiFi Policy. The top navigation bar includes 'XenMobile', 'Analyze', 'Manage', and 'Configure'. Below this, there are tabs for 'Device Policies', 'Apps', 'Actions', 'ShareFile', 'Enrollment Profiles', and 'Delivery Groups'. The main content area is titled 'WiFi Policy' and contains a sidebar with a list of platforms (iOS, Mac OS X, Android, Windows Phone, Windows Desktop/Tablet, Windows Mobile/CE) and a 'Policy Info' section. The main configuration area includes fields for 'Network name*', 'Device-to-device connection (ad-hoc)' (OFF), 'Network' (Internet), 'Authentication' (Open), 'Encryption' (WEP), 'Key provided (automatic)' (OFF), 'Password', and 'Key index' (1). There is also a 'Deployment Rules' section. At the bottom right, there are 'Back' and 'Next >' buttons.

Configure these settings:

- **Network name:** Type the SSID that is in the list of available networks on the user device.

- **Device-to-device connection (ad-hoc):** Allows two devices to connect directly. Default is **Off**.
- **Network:** Choose whether the device is connected to an external internet source or an Office intranet.
- **Authentication:** In the list, choose the type of security to use with the WiFi connection.
 - Open
 - WPA Personal
 - WPA-2 Personal
 - WPA-2 Enterprise

The following sections list the options you configure for each of the preceding connection types.

Open

- **Hidden network (Enable if network is open or off):** Choose whether the network is hidden.
- **Connect automatically:** Choose whether to connect to the network automatically.

WPA Personal, WPA-2 Personal

- **Encryption:** In the list, choose either **AES** or **TKIP** to set the type of encryption. The default is **AES**.
- **Hidden network (Enable if network is open or off):** Choose whether the network is hidden.
- **Connect automatically:** Choose whether to connect to the network automatically.

WPA-2 Enterprise

- **Encryption:** In the list, choose either **AES** or **TKIP** to set the type of encryption. The default is **AES**.
- **EAP Type:** in the list, choose either **PEAP-MSCHAPv2** or **TLS** to set the EAP type. The default is **PEAP-MSCHAPv2**.
- **Connect if hidden:** Choose whether the network is hidden.
- **Connect automatically:** Choose whether to connect to the network automatically.
- **Push certificate via SCEP:** Choose whether to push the certificate to user devices by using Simple Certificate Enrollment Protocol (SCEP).
- **Credential provider for SCEP:** In the list, choose the SCEP credential provider. The default is **None**.

Key provided (automatic): Choose whether the key is automatically provided. Default is **Off**. •

- **Password:** Type the password in this field.
- **Key index:** Choose the key index. Available options are **1, 2, 3, and 4**.

7. Configure deployment rules and choose delivery groups. For more information, see [Add a device policy](#).

Windows CE certificate device policy

Jun 19, 2017

You can create a device policy in XenMobile to create and deliver Windows Mobile/CE certificates from an external PKI to users' devices. See [Certificates](#) for more information about Certificates and PKI entities.

1. In the XenMobile console, click **Configure > Device Policies**. The **Device Policies** page appears.
2. Click **Add**. The **Add New Policy** dialog box appears.
3. Expand **More** and then, under **Security**, click **Windows CE Certificate**. The **Windows CE Certificate Policy** information page appears.
4. In the **Policy Information** pane, type the following information:
 - **Policy Name:** Type a descriptive name for the policy.
 - **Description:** Type an optional description of the policy.
5. Click **Next**. The **Windows CE Certificate Policy Platform** information page appears.

The screenshot shows the XenMobile console interface. The top navigation bar includes 'XenMobile', 'Analyze', 'Manage', and 'Configure'. The 'Configure' section is active, showing 'Device Policies', 'Apps', 'Actions', 'ShareFile', and 'Delivery Groups'. The main content area is titled 'Windows CE Certificate Policy' and contains a 'Policy Information' section. This section includes a description and four configuration fields: 'Credential Provider' (set to 'None'), 'Password of generated PKCS#12', 'Destination folder' (set to '%My Documents%'), and 'Destination file name'. Below these fields is a 'Deployment Rules' section. At the bottom right, there are 'Back' and 'Next >' buttons.

6. Configure these settings:

- **Credential provider:** In the list, click the credential provider. The default is **None**.
- **Password of generated PKCS#12:** Type the password used to encrypt the credential.
- **Destination folder:** In the list, click the destination folder for the credential or click **Add new** to add a folder not already in the list. The predefined options are:
 - %Flash Storage%\
 - %XenMobile Folder%\
 - %Program Files%\
 - %My Documents%\

- %Windows%\
- **Destination file name:** Type the name of the credential file.

7. Configure deployment rules and choose delivery groups. For more information, see [Add a device policy](#).

8. Click **Next**. The **Windows CE Certificate Policy** assignment page appears.

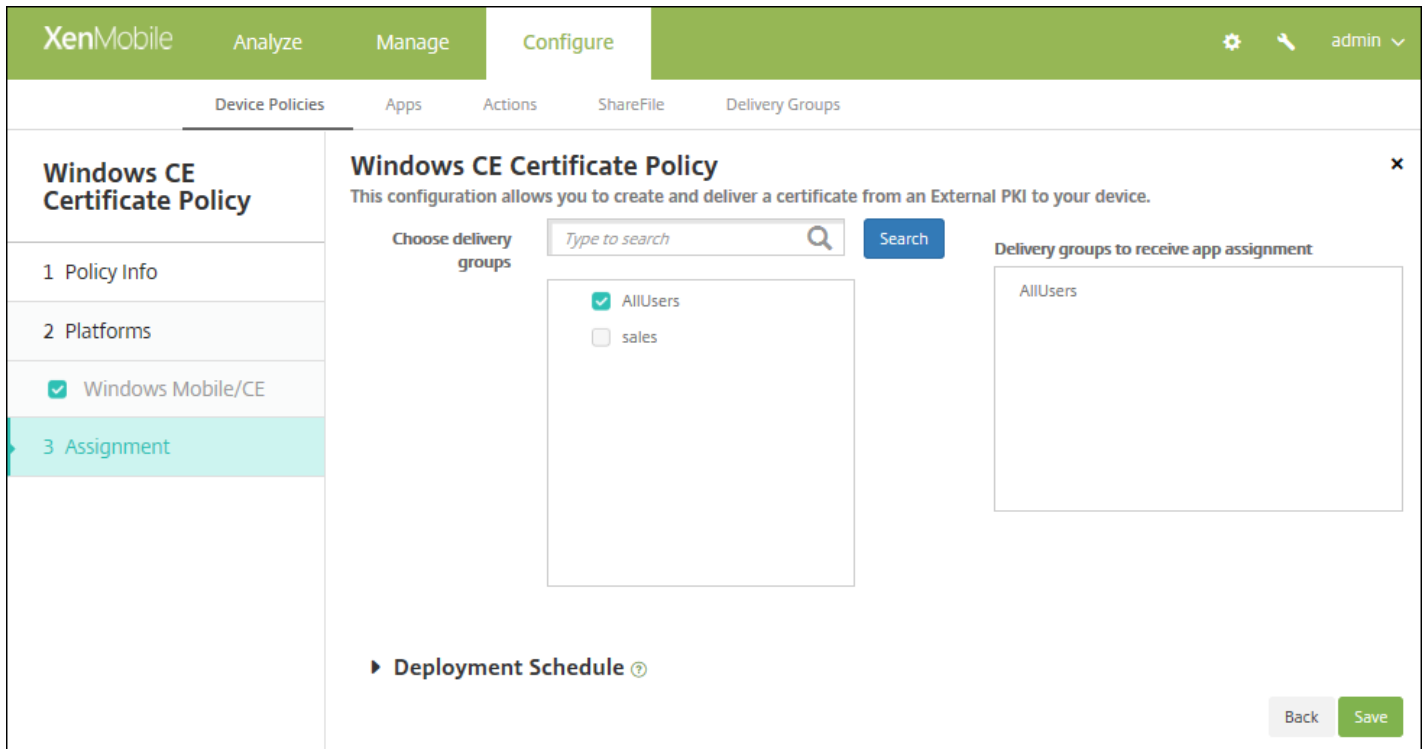

9. Next to **Choose delivery groups**, type to find a delivery group or select a group or groups in the list to which you want to assign the policy. The groups you select appear in the **Delivery groups to receive app assignment** list.

10. Expand **Deployment Schedule** and then configure the following settings:

- Next to **Deploy**, click **ON** to schedule deployment or click **OFF** to prevent deployment. The default option is **ON**. If you choose **OFF**, no other options need to be configured.
- Next to **Deployment schedule**, click **Now** or **Later**. The default option is **Now**.
- If you click **Later**, click the calendar icon and then select the date and time for deployment.
- Next to **Deployment condition**, click **On every connection** or click **Only when previous deployment has failed**. The default option is **On every connection**.
- Next to **Deploy for always-on connection**, click **ON** or **OFF**. The default option is **OFF**.

Note:

- This option applies when you have configured the scheduling background deployment key in **Settings > Server Properties**. The always-on option is not available for iOS devices.
- The deployment schedule you configure is the same for all platforms. Any changes you make apply to all platforms, except for **Deploy for always on connection**, which does not apply to iOS.

11. Click **Save**.

Windows Information Protection device policy

Jun 19, 2017

Windows Information Protection (WIP), previously known as enterprise data protection (EDP), is a Windows technology that protects against the potential leakage of enterprise data. Data leakage can occur through sharing of enterprise data to non-enterprise protected apps, between apps, or outside of the organization network. For more information, see [Protect your enterprise data using Windows Information Protection \(WIP\)](#) on Microsoft TechNet.

You can create a device policy in XenMobile to specify the apps that require Windows Information Protection at the enforcement level you set. The Windows Information Protection policy is for Windows 10 version 1607 and later supervised Phone, Tablet, and Desktop.

XenMobile includes some common apps and you can add others. You specify for the policy an enforcement level that affects the user experience. For example, you can:

- Block any inappropriate data sharing.
- Warn about inappropriate data sharing and allow users to override the policy.
- Run WIP silently while logging and permitting inappropriate data sharing.

To exclude apps from Windows Information Protection, define the apps in Microsoft AppLocker XML files and then import those files into XenMobile.

1. In the XenMobile console, click **Configure** > **Device Policies**. The **Device Policies** page appears.
2. Click **Add**. The **Add a New Policy** dialog box appears.
3. Start typing **Windows Information Protection** and then click that name in the search results. The **Windows Information Protection Policy information** page appears.

The screenshot shows the XenMobile console interface. At the top, there is a navigation bar with 'XenMobile' and tabs for 'Analyze', 'Manage', and 'Configure'. Below this is a sub-navigation bar with 'Device Policies', 'Apps', 'Actions', 'ShareFile', 'Enrollment Profiles', and 'Delivery Groups'. The main content area is titled 'Windows Information Protection Policy' and has a sidebar with three sections: '1 Policy Info', '2 Platforms', and '3 Assignment'. The 'Policy Info' section is active, showing 'Policy Name*' with the value 'WIP' and a 'Description' text area. The 'Platforms' section shows 'Windows Phone' and 'Windows Desktop/Tablet' both checked. The 'Policy Information' pane on the right contains the following text: 'Policy Information' followed by 'This policy lets you specify the apps that require Windows Information Protection at the enforcement level you set. The policy is supported only on Windows 10 (RS1 and above).'

4. In the **Policy Information** pane, enter the following information:

- **Policy Name:** Type a descriptive name for the policy.
- **Description:** Optionally, type a description of the policy.

- Click **Next**. The **Policy Platforms** pane appears.
- Under **Platforms**, select the platforms you want to add. If you are only configuring for one platform, clear the others.

The screenshot shows the XenMobile Configure page for the "Windows Information Protection Policy". The left sidebar has "Platforms" selected, with "Windows Desktop/Tablet" checked. The main area displays a table of Desktop Apps with columns for File name, Publisher, Product name, Version, Allowed, and an Add button.

File name*	Publisher*	Product name*	Version*	Allowed	Add
ieexplore.exe	O=Microsoft Corporation, L=Redmond, S=Washington, C=US	*	*	Allowed	
notepad.exe	O=Microsoft Corporation, L=Redmond, S=Washington, C=US	*	*	Allowed	
onedrive.exe	O=Microsoft Corporation, L=Redmond, S=Washington, C=US	*	*	Allowed	
*	O=Microsoft Corporation, L=Redmond, S=Washington, C=US	Microsoft Office 2016	*	Allowed	

Below the Desktop App table is the "Store App" section with a similar table:

Publisher*	Product name*	Version*	Allowed	Add
CN=Microsoft Corporation, O=Microsoft Corporation, L=Redmond, S=Washington, C=US	Microsoft.MicrosoftEdge	*	Allowed	
CN=Microsoft Corporation, O=Microsoft Corporation, L=Redmond, S=Washington, C=US	Microsoft.Office.Word	*	Allowed	
CN=Microsoft Corporation, O=Microsoft Corporation, L=Redmond, S=Washington, C=US	Microsoft.Office.Excel	*	Allowed	
CN=Microsoft Corporation, O=Microsoft Corporation, L=Redmond, S=Washington, C=US	Microsoft.Office.PowerPoint	*	Allowed	
CN=Microsoft Corporation, O=Microsoft Corporation, L=Redmond, S=Washington, C=US	Microsoft.Office.OneNote	*	Allowed	
CN=Microsoft Corporation, O=Microsoft Corporation, L=Redmond, S=Washington, C=US	microsoft.windowscommunicationsapps	*	Allowed	
CN=AA827FA5-A4F1-46AD-B820-8A79D9C08518	D50536CD.ShareFile	*	Allowed	
CN=Microsoft Corporation, O=Microsoft Corporation, L=Redmond, S=Washington, C=US	microsoft.microsoftskydrive	*	Exempt	

At the bottom, there is an "AppLocker policy file" field with the value "_WIP_denylist.xml" and a "Browse" button.

The screenshot shows the "Enterprise Network Description" and "Windows Information Protection Settings" sections of the XenMobile Configure page.

Enterprise Network Description:

- Enforcement level: 2-Override
- Protected domain names*: testcorp.net
- Data recovery certificate*: CN=yimgd, Serial:56371
- Network domain names*: testcorp.net
- IP range*: 10.0.0.0-10.255.255.255
- IP ranges list is authoritative: ON
- Proxy servers: (empty)
- Internal proxy servers: (empty)
- Cloud resources: citrix.sharefile.com, |citrixdemo-my.sharepoint.com | outlook

Windows Information Protection Settings:

- Revoke WIP certificate on unenroll: ON
- Show overlay icons: OFF

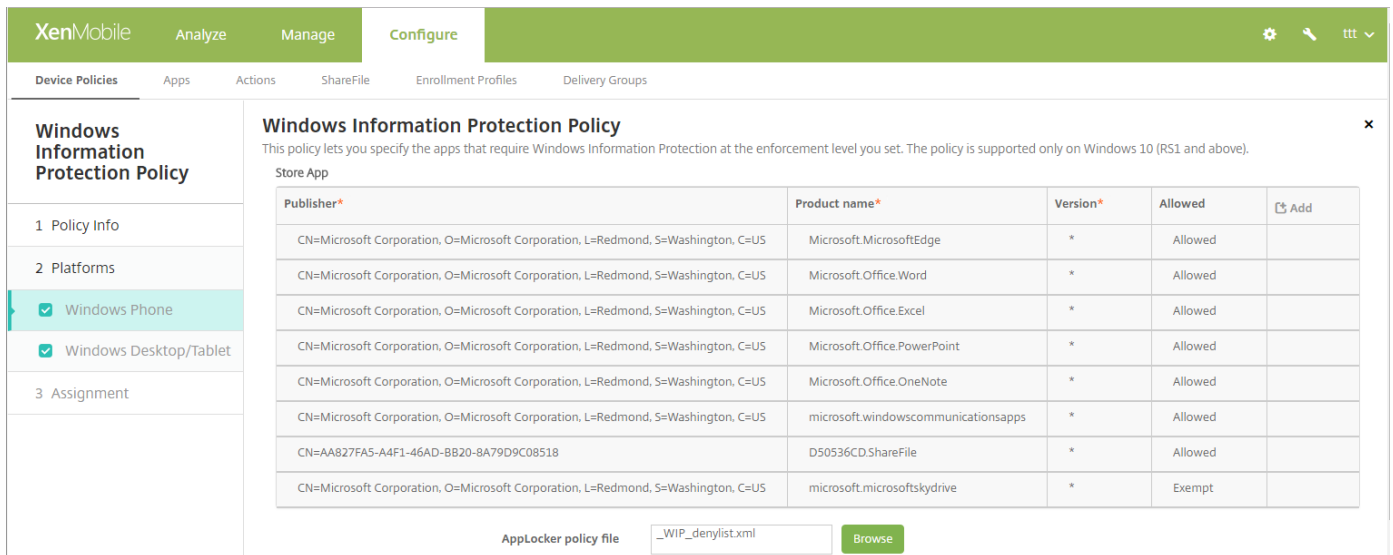

Configure the settings for each platform that you choose:

- **Desktop App (Windows 10 Tablet), Store App (Windows 10 Phone and Tablet):** XenMobile includes some common apps, as shown in the sample above. You can edit or remove those apps as needed.

To add other apps: In the **Desktop App** or **Store App** table, click **Add** and provide the app information.

CN=AA827FA5-A4F1-46AD-BB20-8A79D9C08518	D50536CD.ShareFile	*	Allowed	
CN=Microsoft Corporation, O=Microsoft Corporation, L=Redmond, S=Washington, C=US	microsoft.microsoftskydrive	*	Exempt	
<input type="text"/>	<input type="text"/>	<input type="checkbox"/>	<input checked="" type="radio"/> Allowed <input type="radio"/> Denied <input type="radio"/> Exempt	<input type="button" value="Save"/> <input type="button" value="Cancel"/>

Allowed apps can read, create, and update enterprise data. **Denied** apps can't access enterprise data. **Exempt** apps can read enterprise data but can't create or modify the data.

- **AppLocker XML:** Microsoft provides a list of Microsoft apps that have known compatibility issues with WIP. To exclude those apps from WIP, click **Browse** to upload the list. XenMobile combines the uploaded AppLocker XML and the configured desktop and store apps in the policy sent to the device. For more information, see [Recommended deny list for Windows Information Protection](#).
- **Enforcement level:** Select an option to specify how you want Windows Information Protection to protect and manage data sharing. Defaults to **Off**.
 - **0-Off** - WIP is off and doesn't protect or audit your data.
 - **1-Silent** - WIP runs silently, logs inappropriate data sharing, and doesn't block anything. You can access logs through [Reporting CSP](#).
 - **2-Override** - WIP warns users about potentially unsafe data sharing. Users can override warnings and share the data. This mode logs actions, including user overrides, to your audit log.
 - **3-Block** - WIP prevents users from completing potentially unsafe data sharing.

- **Protected domain names:** The domains that your enterprise uses for its user identities. This list of managed identity domains, along with the primary domain, make up the identity of your managing enterprise. The first domain in the list is the primary corporate identity used in the Windows UI. Use "|" to separate list items. For example: domain1.com | domain2.com
- **Data recovery certificate:** Click **Browse** and then select a recovery certificate to use for data recovery of encrypted files. This certificate is the same as the data recovery agent (DRA) certificate for the encrypting file system (EFS), only delivered through MDM instead of Group Policy. If a recovery certificate isn't available, create it. For information, see "Create a data recovery certificate" in this section.
- **Network domain names:** A list of domains that comprise the boundaries of the enterprise. WIP protects all traffic to the fully qualified domains in this list. This setting, with the **IP range** setting, detects whether a network endpoint is enterprise or personal on private networks. Use a comma to separate list items. For example: corp.example.com,region.example.com
- **IP range:** A list of the enterprise IPv4 and IPv6 ranges that define the computers in the enterprise network. WIP considers these locations as a safe destination for enterprise data sharing. Use commas to separate list items. For example: 10.0.0.0-10.255.255.255, 2001:4898::-2001:4898:7fff:ffff:ffff:ffff:ffff:ffff
- **IP ranges list is authoritative:** To prevent auto-detection of IP ranges by Windows, change this setting to **ON**. Defaults to **OFF**.
- **Proxy servers:** A list of the proxy servers that the enterprise can use for corporate resources. This setting is required if you use a proxy in your network. Without a proxy server, enterprise resources might be unavailable when a client is behind a proxy. For example, resources might be unavailable from certain WiFi hotspots at hotels and restaurants. Use commas to separate list items. For example: proxy.example.com:80;157.54.11.118:443
- **Internal proxy servers:** A list of the proxy servers that your devices go through to reach your cloud resources. Using this server type indicates that the cloud resources you're connecting to are enterprise resources. Don't include in this list any of the servers in the **Proxy servers** setting, which are used for non-WIP-protected traffic. Use commas to separate list items. For example: example.internalproxy1.com;10.147.80.50
- **Cloud resources:** A list of cloud resources protected by WIP. For each cloud resource, you can also optionally specify a proxy server in the **Proxy servers** list to route traffic for this cloud resource. All traffic routed through the **Proxy servers** is treated as enterprise traffic. Use commas to separate list items. For example: domain1.com:InternalProxy.domain1.com, domain2.com:InternalProxy.domain2.com
- **Set Require protection under lock:** Windows 10 Phone only. If **ON**, the Passcode device policy is also required. Otherwise, the Windows Information Protection policy deployment fails. Also, if this policy is **ON**, the setting **Require protection under lock** appears. Default is **OFF**.
- **Require protection under lock:** Windows 10 Phone only. Specifies whether to encrypt enterprise data using a key that's protected by an employee PIN on a locked device. Apps can't read corporate data on a locked device. Defaults to **ON**.
- **Revoke WIP certificate on unenroll:** Specifies whether to revoke local encryption keys from a user device when it's unenrolled from Windows Information Protection. After the encryption keys are revoked, a user can't access

encrypted corporate data. If **OFF**, the keys aren't revoked and the user continues to have access to protected files after unenrollment. Defaults to **ON**.

- **Show overlay icons:** Specifies whether to include the Windows Information Protection icon overlay on corporate files in Explorer and enterprise only app tiles in the Start menu. Defaults to **OFF**.

Note

For general information about configuring policies, see [Add a device policy](#).

A data recover certificate is required to enable the **Windows Information Protection** policy.

1. On the XenMobile Server, open a command prompt and navigate to a folder (other than Windows\System32) where you want to create a certificate.

2. Run this command:

```
cipher /r:ESFDRA
```

3. When prompted, enter a password to protect the private key file.

The cipher command creates a .cer and a .pfx file.

4. In the XenMobile console, go to **Settings > Certificates** and import the .cer file, which applies to both Windows 10 tablets and phones.

When Windows Information Protection is in effect, apps and files include an icon:

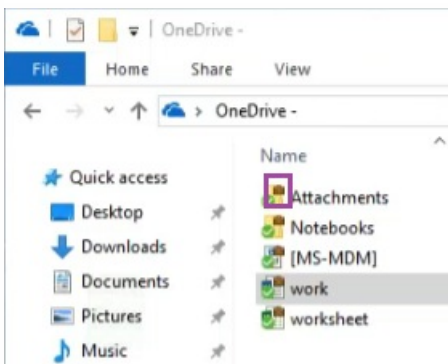
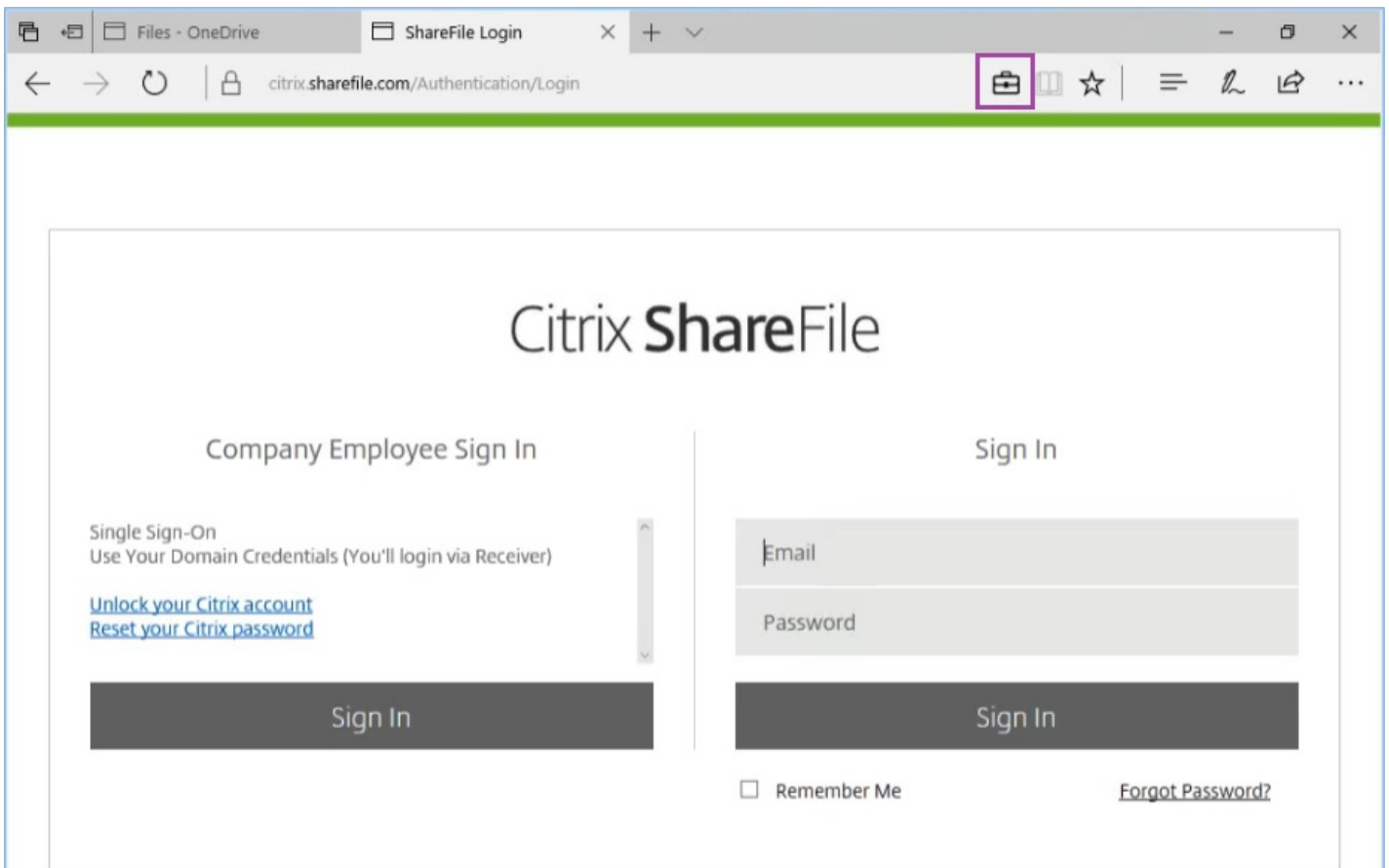

If a user copies or saves a protected file to a non-protected location, the following notification appears, depending on the enforcement level configured.

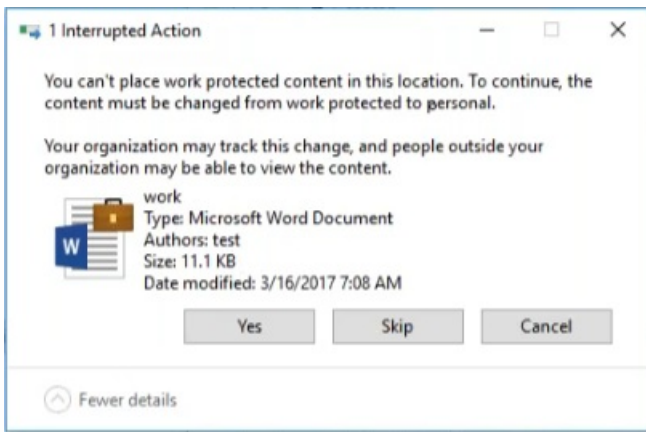

XenMobile options device policy

Jun 19, 2017

You add a XenMobile options policy to configure Secure Hub behavior when connecting to XenMobile from Android and Windows Mobile/CE devices.

1. In the XenMobile console, click **Configure > Device Policies**. The **Device Policies** page appears.
 2. Click **Add**. The **Add a New Policy** dialog box appears.
 3. Expand **More** and then, under **XenMobile agent**, click **XenMobile Options**. The **XenMobile Options Policy** page appears.
 4. In the **Policy Information** pane, enter the following information:
 - **Policy Name:** Type a descriptive name for the policy.
 - **Description:** Type an optional description of the policy.
 5. Click **Next**. The **Policy Platforms** page appears.
 6. Under **Platforms**, select the platforms you want to add. If you are only configuring for one platform, clear the others.
- When you finish configuring the settings for a platform, refer to Step 7 for how to set that platform's deployment rules.

The screenshot displays the XenMobile console interface for configuring a policy. The main content area is titled "XenMobile Options Policy" and includes a sub-header "This policy lets you configure parameters for connections to XenMobile." Below this, there are three main configuration sections: "Device agent configuration", "Remote support", and "Deployment Rules".

- Device agent configuration:**
 - "Traybar notification - hide traybar icon" is set to **OFF**.
 - "Connection time-out(s)*" is set to **20**.
 - "Keep-alive interval(s)*" is set to **120**.
- Remote support:**
 - "Prompt the user before allowing remote control" is set to **OFF**.
 - "Before a file transfer" is set to **Do not warn the user**.
- Deployment Rules:** This section is currently collapsed.

The left sidebar shows the "XenMobile Options Policy" page with three steps: "1 Policy Info", "2 Platforms", and "3 Assignment". The "2 Platforms" step is selected, and the "Android" and "Windows Mobile/CE" platforms are checked. The top navigation bar shows "XenMobile" and "Configure" tabs, and the user "admin" is logged in.

Configure these settings:

- **Traybar notification - hide traybar icon:** Select whether the traybar icon is hidden or visible. The default is **OFF**.

- **Connection: time-out(s):** Type the length of time in seconds that a connection can be idle before the connection times out. The default is 20 seconds.
- **Keep-alive interval(s):** Type the length of time in seconds to keep a connection open. The default is 120 seconds.
- **Prompt the user before allowing remote control:** Select whether to prompt the user before allowing remote support control. The default is **OFF**.
- **Before a file transfer:** In the list, click whether to warn the user about a file transfer or whether to ask the user for permission. Available values: **Do not warn the user**, **Warn the user**, and **Ask for user permission**. The default is **Do not warn the user**.

The screenshot shows the XenMobile Configure interface. The top navigation bar includes 'XenMobile', 'Analyze', 'Manage', and 'Configure'. Below this, there are tabs for 'Device Policies', 'Apps', 'Actions', 'ShareFile', and 'Delivery Groups'. The main content area is titled 'XenMobile Options Policy' and includes a sidebar with '1 Policy Info', '2 Platforms' (with 'Android' and 'Windows Mobile/CE' selected), and '3 Assignment'. The main configuration area is divided into sections: 'Device agent configuration' with settings for backup configuration (Disabled), connecting to office and Internet networks (all ON), and built-in networks (all ON); 'Remote support' with 'Prompt the user before allowing remote control' (OFF) and 'Before a file transfer' (Do not warn the user); and 'Deployment Rules'. At the bottom right, there are 'Back' and 'Next >' buttons.

Configure these settings:

- **Device agent configuration**
 - **XenMobile backup configuration:** In the list, click an option for backing up the XenMobile configuration on the users' devices. The default is **Disabled**. Available options are:
 - Disabled
 - At first connection after XenMobile installation
 - At first connection after each device reboot

- **Connect to the office network**
- **Connect to the Internet network**
- **Connect to the built-in office network:** When set to **ON**, XenMobile automatically detects the network.
- **Connect to the built-in Internet network:** When set to **ON**, XenMobile automatically detects the network.
- **Traybar notification - hide traybar icon:** Select whether the traybar icon is hidden or visible. The default is **OFF**.
- **Connection time-out(s):** Type the length of time in seconds that a connection can be idle before the connection times out. The default is 20 seconds.
- **Keep-alive interval(s):** Type the length of time in seconds to keep a connection open. The default is 120 seconds.
- **Remote support**
 - **Prompt the user before allowing remote control:** Select whether to prompt the user before allowing remote support control. The default is **OFF**.
 - **Before a file transfer:** In the list, click whether to warn the user about a file transfer or whether to ask the user for permission. Available values: **Do not warn the user**, **Warn the user**, and **Ask for user permission**. The default is **Do not warn the user**.

7. Configure deployment rules and choose delivery groups. For more information, see [Add a device policy](#).

XenMobile uninstall device policy

Jun 19, 2017

You can add a device policy in XenMobile to uninstall XenMobile from Android and Window Mobile/CE devices. When deployed, this policy removes XenMobile from all devices in the deployment group.

1. In the XenMobile console, click **Configure > Device Policies**. The **Device Policies** page appears.
 2. Click **Add**. The **Add a New Policy** dialog box appears.
 3. Expand **More** and then, under **XenMobile agent**, click **XenMobile Uninstall**. The **XenMobile Uninstall Policy** page appears.
 4. In the **Policy Information** pane, enter the following information:
 - **Policy Name:** Type a descriptive name for the policy.
 - **Description:** Optionally, type a description of the policy.
 5. Click **Next**. The **Policy Platforms** information page appears.
 6. Under **Platforms**, select the platforms you want to add. If you are only configuring for one platform, clear the others.
- When you finish configuring the settings for a platform, refer to Step 7 for how to set that platform's deployment rules.

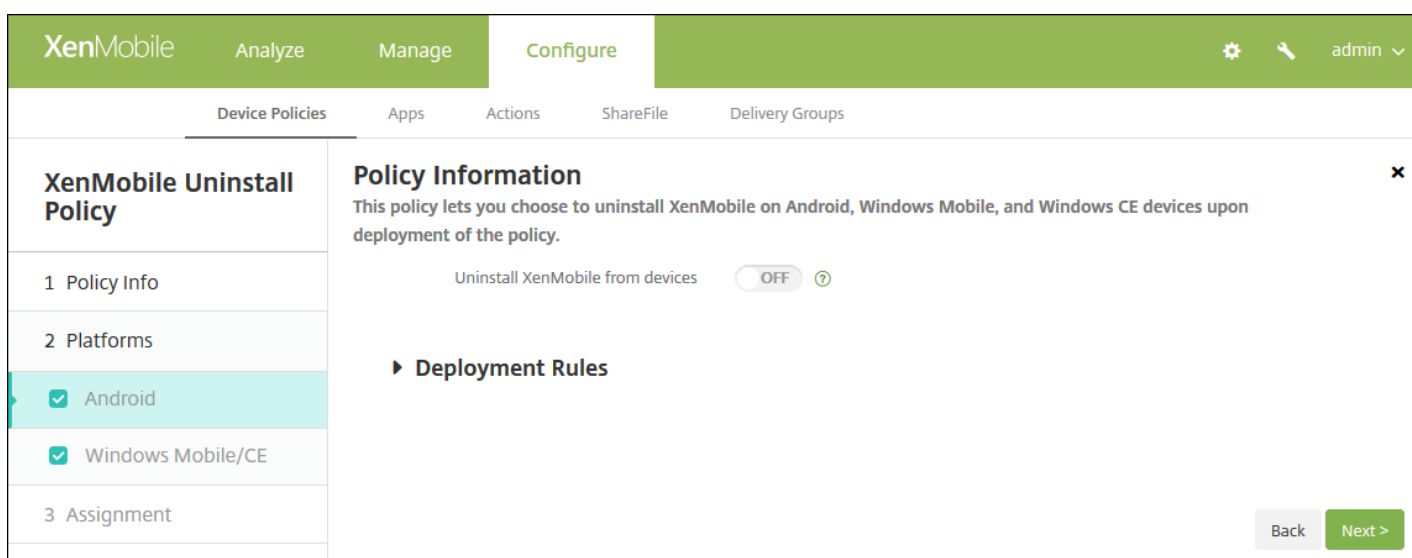

Configure this setting for each platform you choose:

- **Uninstall XenMobile from devices:** Select whether to uninstall XenMobile from every device to which you deploy this policy. The default is **OFF**.
7. Configure deployment rules and choose delivery groups. For more information, see [Add a device policy](#).

Add apps

Jun 19, 2017

You add apps to XenMobile for management. You add the apps to the XenMobile console, where you can then arrange the apps in categories and deploy the apps to users.

You can add the following types of apps to XenMobile:

- **MDX.** These apps are wrapped with the MDX Toolkit. You deploy MDX apps that you get from internal and public stores.
- **Public App Store.** These apps include free or paid apps available in a public app store, such as iTunes or Google Play. For example, GoToMeeting.
- **Web and SaaS.** These apps include apps accessed from an internal network (web apps) or over a public network (SaaS). You can create your own apps, or choose from a set of app connectors for single sign-on authentication to existing Web apps. For example, GoogleApps_SAML.
- **Enterprise.** These apps are native apps that are not wrapped with the MDX Toolkit and do not contain the policies associated with MDX apps.
- **Web Link.** These apps are Web addresses (URLs) to public or private sites, or to web apps that don't require single sign-on.

Note

Citrix supports the silent installation of iOS and Samsung Android apps. Silent installation means that users are not prompted to install apps that you deploy to the device. The apps install silently in the background.

Prerequisites to implement silent installation:

- For iOS apps, put the managed iOS device in supervised mode. For details, see [Import iOS & Mac OS X Profile device policies](#).
- For Android apps, enable Samsung for Enterprise (SAFE) or KNOX policies on the device. To do so, you set the Samsung MDM license key device policy to generate Samsung ELM and KNOX license keys. For details, see [Samsung MDM license key device policies](#).

XenMobile supports iOS, Android, and Windows apps, including XenMobile Apps, such as Secure Hub, Secure Mail and Secure Web, and the use of MDX policies. Using the XenMobile console, you can upload apps and then deliver the apps to user devices. In addition to the XenMobile Apps, you can add the following types of apps:

- Apps you develop for your users.
- Apps in which you want to allow or restrict device features by using MDX policies.

To distribute XenMobile Apps for iOS and Android, follow these general steps:

1. Download the public-store MDX files from Citrix.
2. Upload those files to the XenMobile console (**Configure > Apps**), updating MDX policies as needed.
3. Upload the MDX files to the public app stores. For more information, see [Add an MDX app](#) in this article.

To distribute XenMobile Apps for Windows, follow these general steps:

1. Download the app files from Citrix.
2. Wrap the app files using the MDX Toolkit.
3. Upload the wrapped apps to the XenMobile console, modifying the MDX policies as needed.
4. Deliver the apps to user devices through delivery groups. For details, see [Public App Store Delivery of XenMobile Apps](#) in the XenMobile Apps documentation.

The MDX Toolkit wraps apps for iOS, Android, and Windows devices with Citrix logic and policies. The tool can securely wrap an app that was created within your organization or an app created outside the company.

XenMobile comes with a set of application connectors, which are templates that you can configure for single sign-on to web and SaaS apps. Sometimes you can configure the templates for user account creation and management. XenMobile includes Security Assertion Markup Language (SAML) connectors. SAML connectors are used for web applications that support SAML protocol for SSO and user account management. XenMobile supports SAML 1.1 and SAML 2.0.

You can also build your own enterprise SAML connectors.

For more information, see [Add a Web or SaaS app](#) in this article.

Enterprise applications typically reside in your internal network. Users can connect to the apps by using Secure Hub. When you add an enterprise app, XenMobile creates the app connector for it. For more information, see [Add an enterprise app](#) in this article.

You can configure settings to retrieve app names and descriptions from the Apple App Store, Google Play, and the Windows Store. When you retrieve the app information from the store, XenMobile overwrites the existing name and description. For more information, see [Add a public app store app](#) in this article.

A web link is a web address to an internet or intranet site. A web link can also point to a web application that doesn't require SSO. When you finish configuring a web link, the link appears as an icon in the XenMobile Store. When users log on with Secure Hub, the link appears with the list of available apps and desktops. For more information, see [Add a Web Link app](#) in this article.

Add an MDX app

When you receive a wrapped MDX mobile app for an iOS, Android, or Windows Phone device, you can upload the app to XenMobile. After you upload the app, you can configure app details and policy settings. For more information about the app policies that are available for each device platform type, see [MDX Policies at a Glance](#). Detailed policy descriptions also in that section.

1. In the XenMobile console, click **Configure > Apps**. The **Apps** page appears.

The screenshot shows the XenMobile console interface. The top navigation bar includes 'XenMobile', 'Analyze', 'Manage', and 'Configure'. Below this, there are tabs for 'Device Policies', 'Apps', 'Actions', 'ShareFile', 'Enrollment Profiles', and 'Delivery Groups'. The 'Apps' tab is active, displaying a list of apps. At the top of the app list, there are buttons for 'Add', 'Category', and 'Export', along with a search bar. The app list table has the following data:

Icon	App Name	Type	Category	Created On	Last Updated	Disable
	hh viber	Public App Store	Default	10/18/16 7:55 AM	10/18/16 7:55 AM	<input type="checkbox"/>
	hh ebay	Public App Store	Default	10/18/16 8:04 AM	10/18/16 8:04 AM	<input type="checkbox"/>
	hh green	Enterprise	Default	10/18/16 8:07 AM	10/18/16 8:07 AM	<input type="checkbox"/>
	hh pink	Enterprise	Default	10/18/16 8:08 AM	10/18/16 8:08 AM	<input type="checkbox"/>
	hh web & saas	Web & SaaS	Default	10/18/16 8:09 AM	10/18/16 8:09 AM	<input type="checkbox"/>
	hh weblink	Web Link	Default	10/18/16 8:10 AM	10/18/16 8:10 AM	<input type="checkbox"/>
	MRF Android Enterprise TD	Enterprise	Default	10/18/16 8:12 AM	10/18/16 8:12 AM	<input type="checkbox"/>
	hh UWH	Enterprise	Default	10/18/16 8:17 AM	10/18/16 8:17 AM	<input type="checkbox"/>
	hh WW	MDX	Default	10/18/16 8:18 AM	10/18/16 8:18 AM	<input type="checkbox"/>

2. Click **Add**. The **Add App** dialog box appears.

The 'Add App' dialog box contains the following information:

Click an app type and then follow the steps to add a deployable app. The app appears in the app table after you complete the steps.

- MDX**
Apps wrapped with the MDX Toolkit to include app policies. You can deploy MDX apps obtained from internal and public stores.
Example: WorxMail
- Public App Store**
Free or paid apps available in a public app store, such as iTunes or Google Play, for download.
Example: GoToMeeting
- Web & SaaS**
Apps accessed from an internal network (Web apps) or over a public network (SaaS). You can create your own apps or choose from a set of app connectors for single sign-on authentication to web apps.
Example: GoogleApps_SAML
- Enterprise**
Native apps not wrapped with the MDX Toolkit and that do not contain the policies found in MDX apps.
Example: Quick-iLaunch
- Web Link**
A Web address (URL) to a public or private site or to a Web app that doesn't require single sign-on.

3. Click **MDX**. The **MDX App Information** page appears.

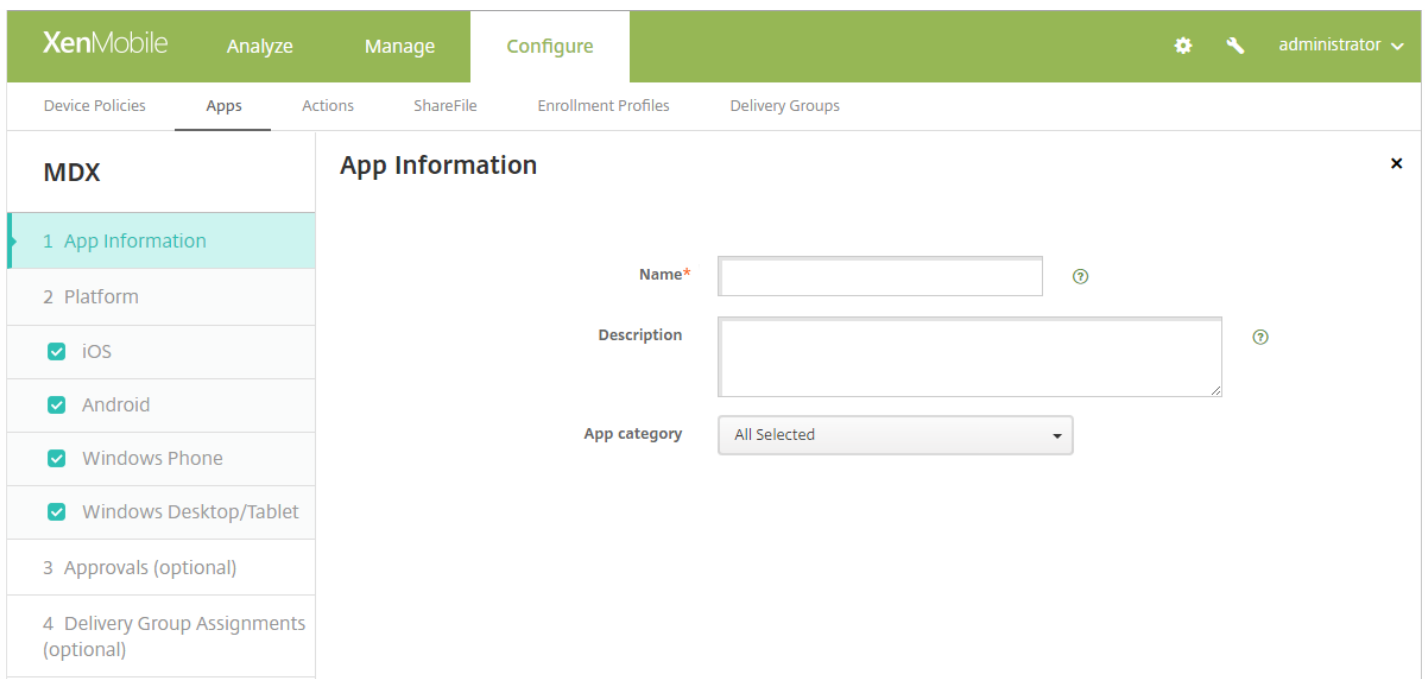

4. On the **App Information** pane, type the following information:

- **Name:** Type a descriptive name for the app. The name appears under **App Name** on the **Apps** table.
- **Description:** Type an optional description of the app.
- **App category:** Optionally, in the list, click the category to which you want to add the app. For more information about app categories, see [Create app categories](#).

5. Click **Next**. The **App Platforms** page appears.

6. Under **Platforms**, select the platforms you want to add. If you are only configuring for one platform, clear the others.

When you finish configuring the settings for a platform, see Step 11 for how to set the platform deployment rules.

7. Select an MDX file to upload by clicking **Upload** and navigating to the file location.

- If you are adding an iOS VPP B2B app, click **Your application is a VPP B2B application?**. Then, in the list, click the B2B VPP account to use.

8. Click **Next**. The app details page appears.

9. Configure these settings:

- **File name:** Type the file name associated with the app.
- **App Description:** Type a description for the app.
- **App version:** Optionally, type the app version number.
- **Minimum OS version:** Optionally, type the oldest operating system version that the device can run to use the app.
- **Maximum OS version:** Optionally, type the most recent operating system that the device must run to use the app.
- **Excluded devices:** Optionally, type the manufacturer or models of devices that cannot run the app.
- **Remove app if MDM profile is removed:** Select whether to remove the app from a device when the MDM profile is removed. The default is **ON**.
- **Prevent app data backup:** Select whether to prevent users from backing up app data. The default is **ON**.

- **Force app to be managed:** Select whether, when the app is installed unmanaged, to prompt users to allow the app to be managed on unsupervised devices. The default is **ON**. Available in iOS 9.0 and later.

10. Configure the **MDX Policies**. MDX policies vary by platform and include options for such policy areas as Authentication, Device Security, Encryption, App Interaction, and App Restrictions. In the console, each of the policies has a tooltip that describes the policy.

For more information about app policies for MDX apps, see [MDX Policies at a Glance](#). That article includes a table showing which policies apply to each platform.

11. Configure the deployment rules.

12. Expand **XenMobile Store Configuration**.

Store Configuration

App FAQ

Add a new FAQ question and answer

App screenshots

Choose File

Choose File

Choose File

Choose File

Choose File

Allow app ratings

Allow app comments

Optionally, you can add an FAQ for the app or screen captures that appear in the XenMobile Store. You can also set whether users can rate or comment on the app.

- Configure these settings:
 - **App FAQ:** Add FAQ questions and answers for the app.

- **App screenshots:** Add screen captures to help classify the app in the XenMobile Store. The graphic you upload must be a PNG. You cannot upload a GIF or JPEG image.
- **Allow app ratings:** Select whether to permit a user to rate the app. The default is **ON**.
- **Allow app comments:** Select whether to permit users to comment about the selected app. The default is **ON**.

13. Click **Next**. The **Approvals** page appears.

The screenshot shows the XenMobile configuration interface. The top navigation bar includes 'XenMobile', 'Analyze', 'Manage', and 'Configure'. Below this, there are tabs for 'Device Policies', 'Apps', 'Actions', 'ShareFile', 'Enrollment Profiles', and 'Delivery Groups'. The 'Apps' tab is active, and the 'MDX' app is selected. The 'Approvals (optional)' page is displayed, with a sidebar on the left showing the configuration steps: 1 App Information, 2 Platform, 3 Approvals (optional) (highlighted), and 4 Delivery Group Assignments (optional). The main content area shows the 'Approvals (optional)' title, a subtitle 'Apply an existing workflow or create a new workflow to require approval before allowing users to access the app.', and a 'Workflow to Use' dropdown menu currently set to 'None'.

You use workflows when you need approval when creating user accounts. If you don't need to set up approval workflows, you can skip to Step 15.

Configure this setting if you need assign or create a workflow:

- **Workflow to Use:** In the list, click an existing workflow or click **Create a new workflow**. The default is **None**.
- If you select **Create a new workflow**, configure these settings. For more information, see [Create and manage workflows](#).
 - **Name:** Type a unique name for the workflow.
 - **Description:** Optionally, type a description for the workflow.
 - **Email Approval Templates:** In the list, select the email approval template to be assigned. When you click the eye icon to the right of this field, a dialog box appears where you can preview the template.
 - **Levels of manager approval:** In the list, select the number of levels of manager approval required for this workflow. The default is 1 level. Possible options are:
 - Not Needed
 - 1 level
 - 2 levels
 - 3 levels
 - **Select Active Directory domain:** In the list, select the appropriate Active Directory domain to be used for the workflow.
 - **Find additional required approvers:** Type the name of the additional required person in the search field and then click **Search**. Names originate in Active Directory.

- When the name appears in the field, select the check box next to the name. The name and email address appear in the **Selected additional required approvers** list.
- To remove a person from the **Selected additional required approvers** list, do one of the following:
 - Click **Search** to see a list of all the persons in the selected domain.
 - Type a full or partial name in the search box, and then click **Search** to limit the search results.
 - Persons in the **Selected additional required approvers** list have check marks next to their name in the search results list. Scroll through the list and clear the check box next to each name you want to remove.

14. Click **Next**. The **Delivery Group Assignment** page appears.

The screenshot shows the XenMobile configuration interface. The top navigation bar includes 'XenMobile', 'Analyze', 'Manage', and 'Configure'. The 'Configure' tab is active, and the 'Delivery Groups' sub-tab is selected. The main content area is titled 'Delivery Group Assignments (optional)' and includes a search box and a list of delivery groups. The 'AllUsers' group is selected, and it is listed in the 'Delivery groups to receive app assignment' list. The 'Deployment Schedule' section is expanded, showing options for 'Deploy', 'Deployment schedule', 'Deployment condition', and 'Deploy for always-on connection'.

15. Next to **Choose delivery groups**, type to find a delivery group or select a group or groups in the list. The groups you select appear in the **Delivery groups to receive app assignment** list.

16. Expand **Deployment Schedule** and then configure the following settings:

- Next to **Deploy**, click **ON** to schedule deployment or click **OFF** to prevent deployment. The default option is **ON**.
- Next to **Deployment schedule**, click **Now** or **Later**. The default option is **Now**.
- If you click **Later**, click the calendar icon and then select the date and time for deployment.
- Next to **Deployment condition**, click **On every connection** or click **Only when previous deployment has failed**. The default option is **On every connection**.
- Next to **Deploy for always-on connection**, click **ON** or **OFF**. The default option is **OFF**.

Note:

- This option applies when you have configured the scheduling background deployment key in **Settings > Server Properties**. The always-on option is not available for iOS devices.
- The deployment schedule you configure is the same for all platforms. Any changes you make apply to all platforms, except for **Deploy for always on connection**, which does not apply to iOS.

17. Click **Save**.

Create app categories

When users log on to Secure Hub, they receive a list of the apps, web links, and stores that you set up in XenMobile. You can use app categories to let users access only certain apps, stores, or web links. For example, you can create a Finance category and then add apps to the category that only pertain to finance. Or, you can configure a Sales category to which you assign sales apps.

You configure categories on the **Apps** page in the XenMobile console. Then, when you add or edit an app, web link, or store, you can add the app to one or more of the configured categories.

1. In the XenMobile console, click **Configure > Apps**. The **Apps** page appears.
2. Click **Category**. The **Categories** dialog box appears.

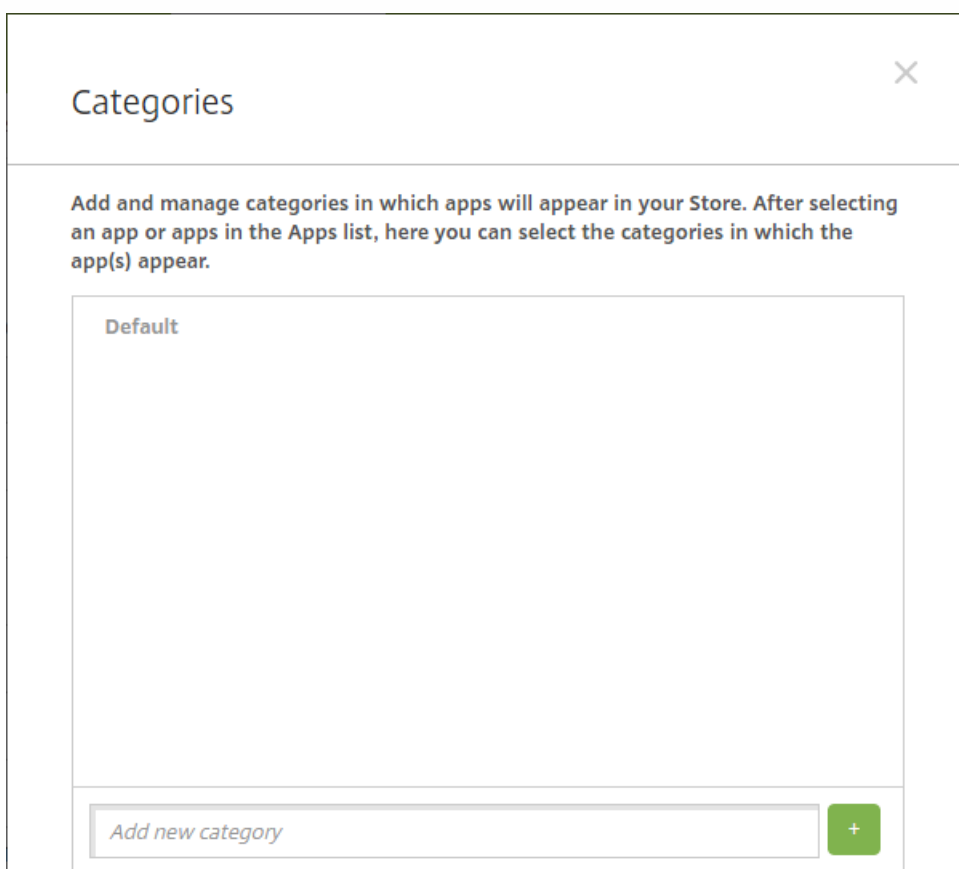

3. For each category you want to add, do the following:

- Type the name of the category you want to add in the **Add a new category** field at the bottom of the dialog box. For example, you might type Enterprise Apps to create a category for enterprise apps.
- Click the plus sign (+) to add the category. The newly created category is added and appears in the **Categories** dialog box.

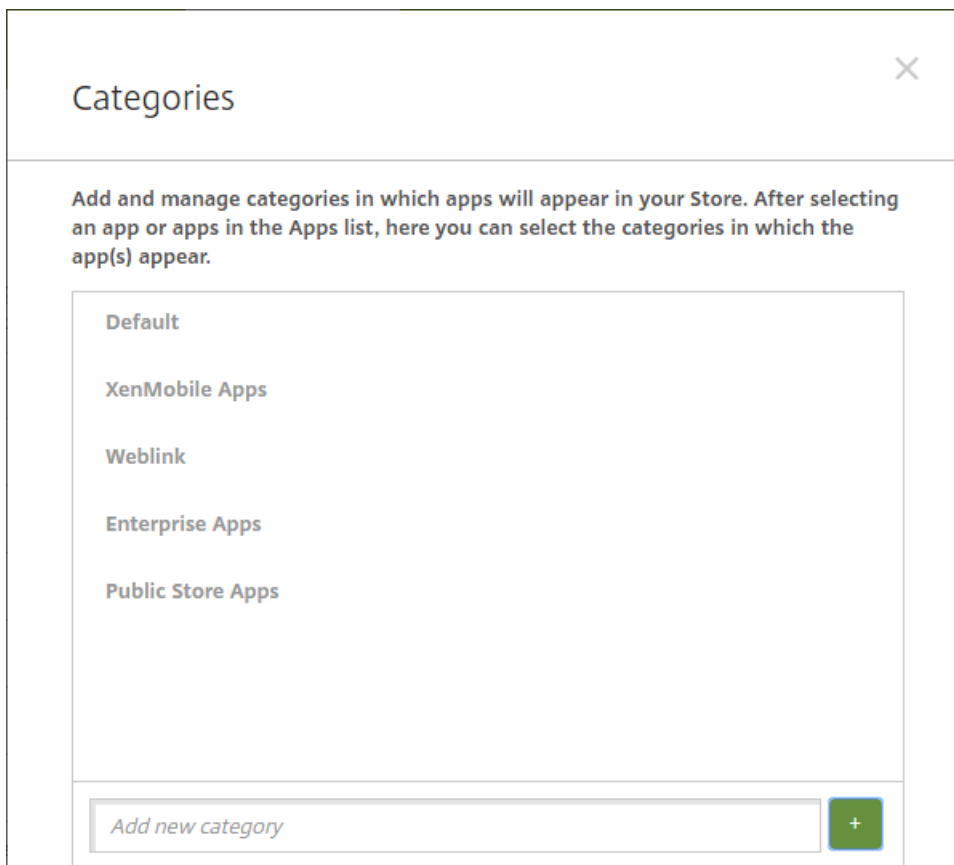

4. When you're done adding categories, close the **Categories** dialog box.
5. On the **Apps** page, you can place an existing app into a new category.
 - Select the app you want to categorize.
 - Click **Edit**. The **App Information** page appears.
 - In the **App category** list, apply the new category by selecting the category check box. Clear the check boxes for any existing categories that you don't want to apply to the app.
 - Click the **Delivery Groups Assignments** tab or click **Next** on each of the following pages to step through the remaining app set-up pages.
 - Click **Save** on the **Delivery Groups Assignments** page to apply the new category. The new category is applied to the app and appears in the **Apps** table.

Add a public app store app

You can add free or paid apps to XenMobile that are available in a public app store, such as iTunes or Google Play. For example, GoToMeeting. Also, when you add a paid public app store app for an Android for Work, you can review the Bulk Purchase licensing status. That status is the total number of licenses available, the number currently in use, and the email address of each user consuming the licenses. The Bulk Purchase plan for Android for Work simplifies the process of finding, buying, and distributing apps and other data in bulk for an organization.

1. In the XenMobile console, click **Configure** > **Apps**. The **Apps** page appears.

XenMobile Analyze Manage **Configure** administrator

Device Policies **Apps** Actions ShareFile Enrollment Profiles Delivery Groups

Apps Show filter

Add | Category | Export

<input type="checkbox"/>	Icon	App Name	Type	Category	Created On	Last Updated	Disable	▼
<input type="checkbox"/>		hh viber	Public App Store	Default	10/18/16 7:55 AM	10/18/16 7:55 AM		
<input type="checkbox"/>		hh ebay	Public App Store	Default	10/18/16 8:04 AM	10/18/16 8:04 AM		
<input type="checkbox"/>		hh green	Enterprise	Default	10/18/16 8:07 AM	10/18/16 8:07 AM		
<input type="checkbox"/>		hh pink	Enterprise	Default	10/18/16 8:08 AM	10/18/16 8:08 AM		
<input type="checkbox"/>		hh web & saas	Web & SaaS	Default	10/18/16 8:09 AM	10/18/16 8:09 AM		
<input type="checkbox"/>		hh weblink	Web Link	Default	10/18/16 8:10 AM	10/18/16 8:10 AM		
<input type="checkbox"/>		MRF Android Enterprise TD	Enterprise	Default	10/18/16 8:12 AM	10/18/16 8:12 AM		
<input type="checkbox"/>		hh UWH	Enterprise	Default	10/18/16 8:17 AM	10/18/16 8:17 AM		
<input type="checkbox"/>		hh WW	MDX	Default	10/18/16 8:18 AM	10/18/16 8:18 AM		

2. Click **Add**. The **Add App** dialog box appears.

Add App ✕

Click an app type and then follow the steps to add a deployable app. The app appears in the app table after you complete the steps.

MDX

Apps wrapped with the MDX Toolkit to include app policies. You can deploy MDX apps obtained from internal and public stores.

Example: WorxMail

Public App Store

Free or paid apps available in a public app store, such as iTunes or Google Play, for download.

Example: GoToMeeting

Web & SaaS

Apps accessed from an internal network (Web apps) or over a public network (SaaS). You can create your own apps or choose from a set of app connectors for single sign-on authentication to web apps.

Example: GoogleApps_SAML

Enterprise

Native apps not wrapped with the MDX Toolkit and that do not contain the policies found in MDX apps.

Example: Quick-iLaunch

Web Link

A Web address (URL) to a public or private site or to a Web app that doesn't require single sign-on.

3. Click **Public App Store**. The **App Information** page appears.

4. On the **App Information** pane, type the following information:

- **Name:** Type a descriptive name for the app. This name appears under **App Name** on the **Apps** table.
- **Description:** Type an optional description of the app.
- **App category:** Optionally, in the list, click the category to which you want to add the app. For more information about app categories, see [Create app categories](#).

5. Click **Next**. The **App Platforms** page appears.

6. Under **Platforms**, select the platforms you want to add. If you are only configuring for one platform, clear the others.

When you finish configuring the settings for a platform, see Step 10 for how to set the platform deployment rules.

7. Select an app to add by typing the app name in the search box and clicking **Search**. Apps matching the search criteria appear. The following figure shows the result of searching for **podio**.

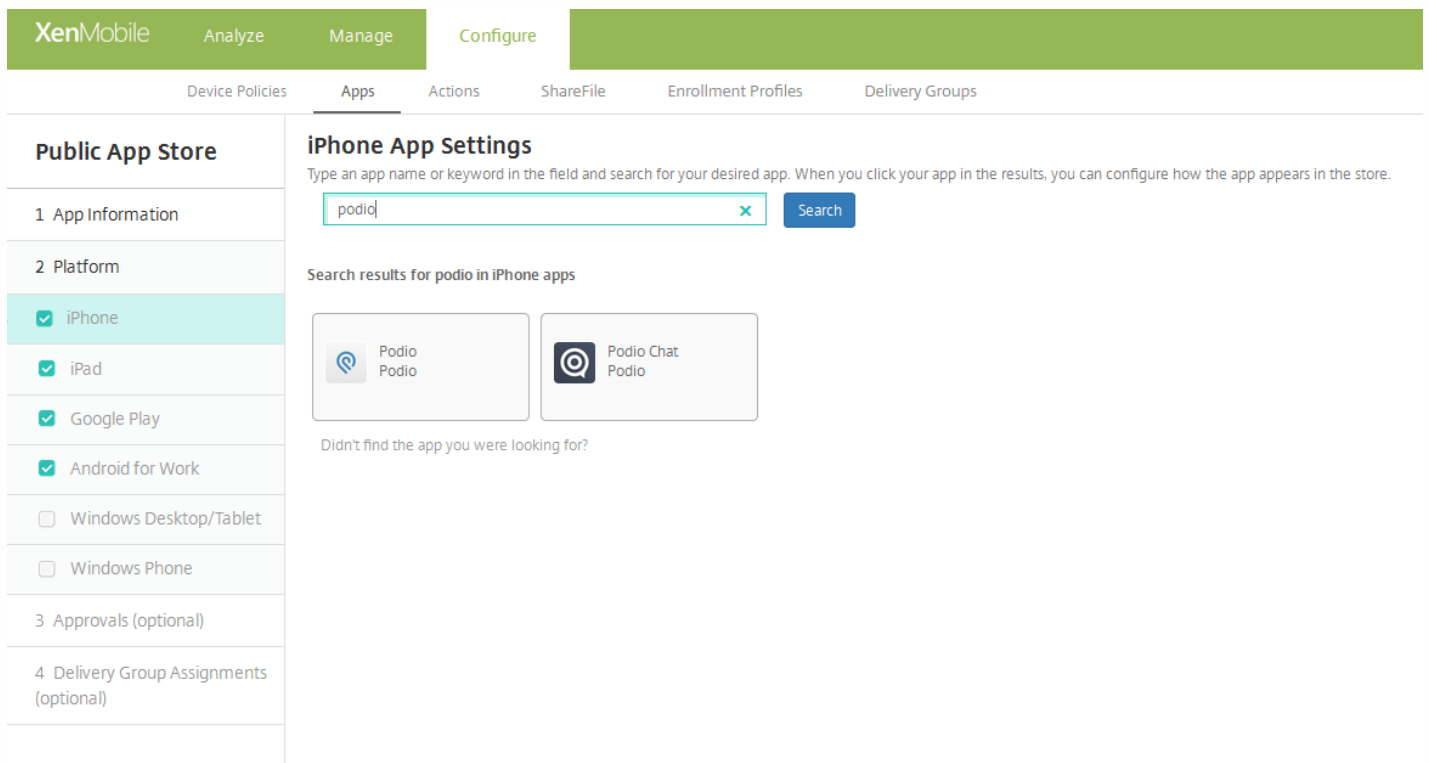

8. Click the app you want to add. The **App Details** fields are pre-populated with information related to the chosen app (including the name, description, version number, and associated image).

App Details

Name*	<input type="text" value="Podio"/>
Description*	<div style="border: 1px solid #ccc; padding: 5px;"><p>The ultimate companion app for Podio – enabling you to run your projects and collaborate with your team from anywhere.</p><p>Take your content and conversations with you, no matter where your workday takes you.</p></div>
Version	<input type="text" value="5.0.1"/>
Image	
Paid app	<input type="checkbox" value="OFF"/>
Remove app if MDM profile is removed	<input checked="" type="checkbox" value="ON"/>
Prevent app data backup	<input checked="" type="checkbox" value="ON"/>
Force app to be managed	<input type="checkbox" value="OFF"/> ⓘ
Force license association to device	<input checked="" type="checkbox" value="ON"/>

9. Configure these settings:

- If necessary, change the name and description for the app.
- **Paid app:** This field is preconfigured and cannot be changed.
- **Remove app if MDM profile is removed:** Select whether to remove the app if the MDM profile is removed. The default is **ON**.
- **Prevent app data backup:** Select whether to prevent the app from backing up data. The default is **ON**.
- **Force app to be managed:** Select whether, when the app is installed unmanaged, to prompt users to allow the app to be managed on unsupervised devices. The default is **OFF**. Available in iOS 9.0 and later.
- **Force license to association to device:** Select whether to associate an app that has been developed with device association enabled to a device rather than to a user. Available in iOS 9 and later. If the app you chose does not support assignment to a device, this field can't be changed.

10. Configure the deployment rules.

11. Expand XenMobile Store Configuration.

▼ **Store Configuration**

App FAQ

Add a new FAQ question and answer

App screenshots

Choose File

Choose File

Choose File

Choose File

Choose File

Allow app ratings

Allow app comments

Optionally, you can add an FAQ for the app or screen captures that appear in the XenMobile Store. You can also set whether users can rate or comment on the app.

- Configure these settings:
 - **App FAQ:** Add FAQ questions and answers for the app.
 - **App screenshots:** Add screen captures to help classify the app in the XenMobile Store. The graphic you upload must be a PNG. You cannot upload a GIF or JPEG image.
 - **Allow app ratings:** Select whether to permit a user to rate the app. The default is ON.
 - **Allow app comments:** Select whether to permit users to comment about the selected app.

12. Expand **Volume Purchase Program** or, for Android for Work, expand **Bulk Purchase**.

For the Volume Purchase Program, complete the following steps.

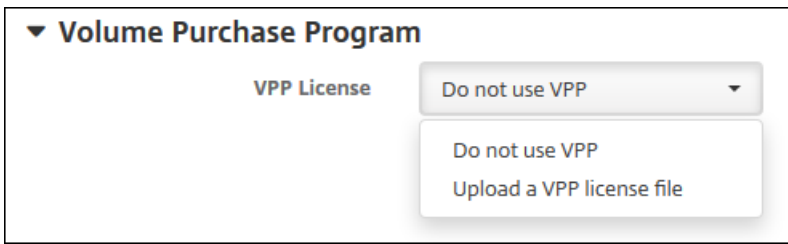

- a. In the **VPP license** list, click **Upload a VPP license file** if you want to enable XenMobile to apply a VPP license for the app.
- b. In the dialog box that appears, import the license.

For Android for Work Bulk Purchase, expand the **Bulk Purchase** section.

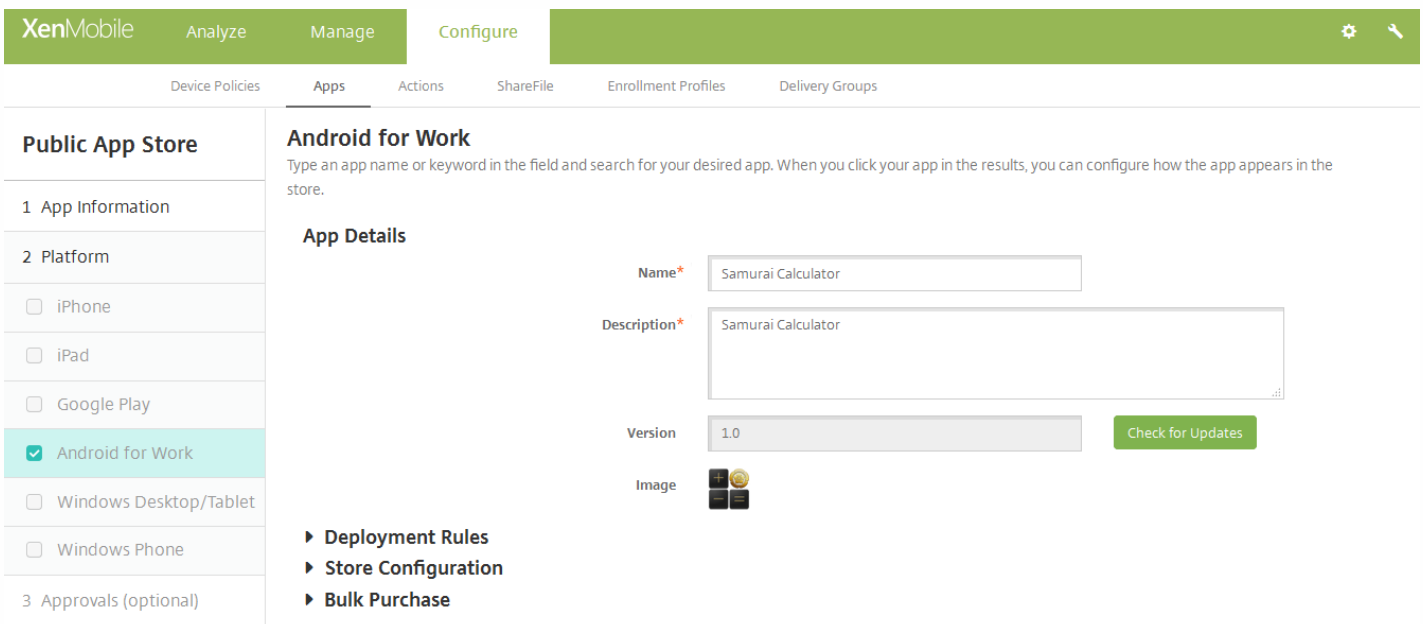

The License Assignment table shows the number of licenses in use for the app, out of the total licenses available.

For Android for Work, you can select a user and then click **Disassociate** to end their license assignment and free up a license for another user. You can only disassociate the license, however, if the user is not part of a delivery group that contains the specific app.

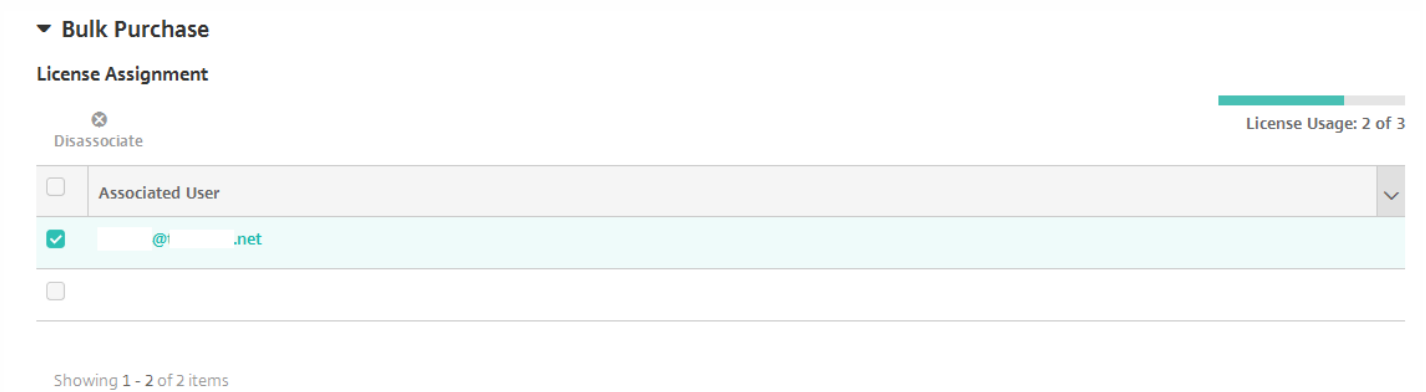

For Android for Work, you can disassociate a license only if the user is not part of a delivery group that contains the specific app.

For iOS, you can disassociate Volume Purchase Program licenses for an individual user, user groups, or for all assignments. Doing so ends the license assignments and frees licenses.

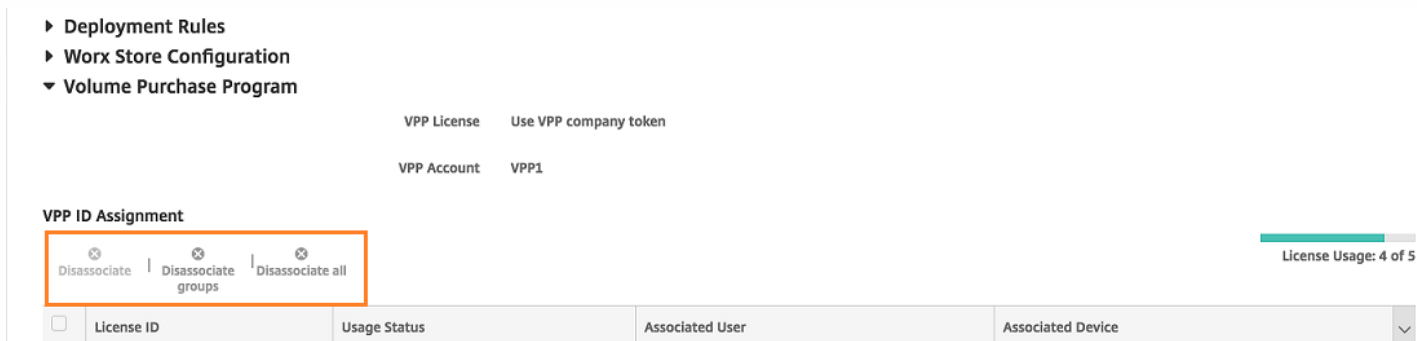

Clicking **Disassociate groups** opens a dialog box where you select groups.

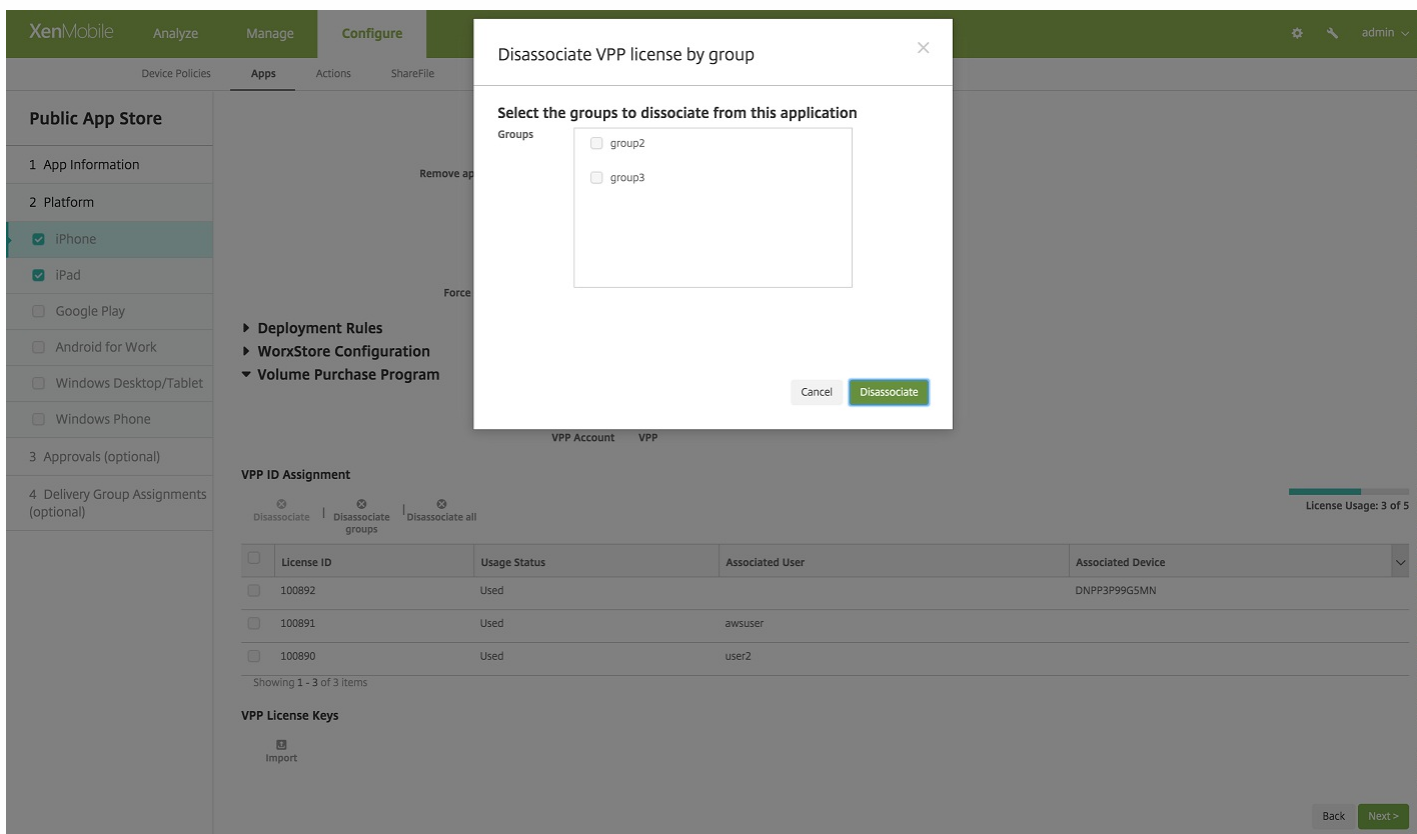

13. After you complete the **Volume Purchase Program** or **Bulk Purchase** settings, click **Next**. The **Approvals** page appears.

You use workflows when you need approval when creating user accounts. If you don't need to set up approval workflows, you can skip to the next step.

Configure these settings if you need to assign or create a workflow:

- **Workflow to Use:** In the list, click an existing workflow or click **Create a new workflow**. The default is **None**.
- If you select **Create a new workflow**, configure these settings:
 - **Name:** Type a unique name for the workflow.
 - **Description:** Optionally, type a description for the workflow.
 - **Email Approval Templates:** In the list, select the email approval template to be assigned. When you click the eye icon to the right of this field, a dialog box appears where you can preview the template.
 - **Levels of manager approval:** In the list, select the number of levels of manager approval required for this workflow. The default is **1 level**. Possible options are:
 - Not Needed
 - 1 level
 - 2 levels
 - 3 levels
 - **Select Active Directory domain:** In the list, select the appropriate Active Directory domain to be used for the workflow.
 - **Find additional required approvers:** Type the name of the additional required person in the search field and then click **Search**. Names originate in Active Directory.
 - When the name appears in the field, select the check box next to the name. The name and email address appear in the **Selected additional required approvers** list.
 - To remove a person from the **Selected additional required approvers** list, do one of the following:
 - Click **Search** to see a list of all the persons in the selected domain.
 - Type a full or partial name in the search box, and then click **Search** to limit the search results.
 - Persons in the **Selected additional required approvers** list have check marks next to their name in the search results list. Scroll through the list and clear the check box next to each name you want to remove.

14. Click **Next**. The **Delivery Group Assignment** page appears.

15. Next to **Choose delivery groups**, type to find a delivery group or select a group or groups in the list. The groups you select appear in the **Delivery groups to receive app assignment** list.

16. Expand **Deployment Schedule** and then configure the following settings:

- Next to **Deploy**, click **ON** to schedule deployment or click **OFF** to prevent deployment. The default option is **ON**.
- Next to **Deployment schedule**, click **Now** or **Later**. The default option is **Now**.
- If you click **Later**, click the calendar icon and then select the date and time for deployment.
- Next to **Deployment condition**, click **On every connection** or click **Only when previous deployment has failed**. The default option is **On every connection**.
- Next to **Deploy for always-on connection**, click **ON** or **OFF**. The default option is **OFF**.

Note:

- This option applies when you have configured the scheduling background deployment key in **Settings > Server Properties**. The always-on option is not available for iOS devices.
- The deployment schedule you configure is the same for all platforms. Any changes you make apply to all platforms, except for **Deploy for always on connection**, which does not apply to iOS.

17. Click **Save**.

Add a Web or SaaS app

Using the XenMobile console, you can give users single sign-on (SSO) authorization to your mobile, enterprise, web, and SaaS apps. You can enable apps for SSO by using application connector templates. For a list of connector types available in XenMobile, see [Application connector types](#). You can also you build your own connector in XenMobile when you add a Web or SaaS app.

If an app is available for SSO only: After you save the settings, the app appears on the **Apps** tab in the XenMobile console.

1. In the XenMobile console, click **Configure > Apps**. The **Apps** page opens.
2. Click **Add**. The **Add App** dialog box appears.

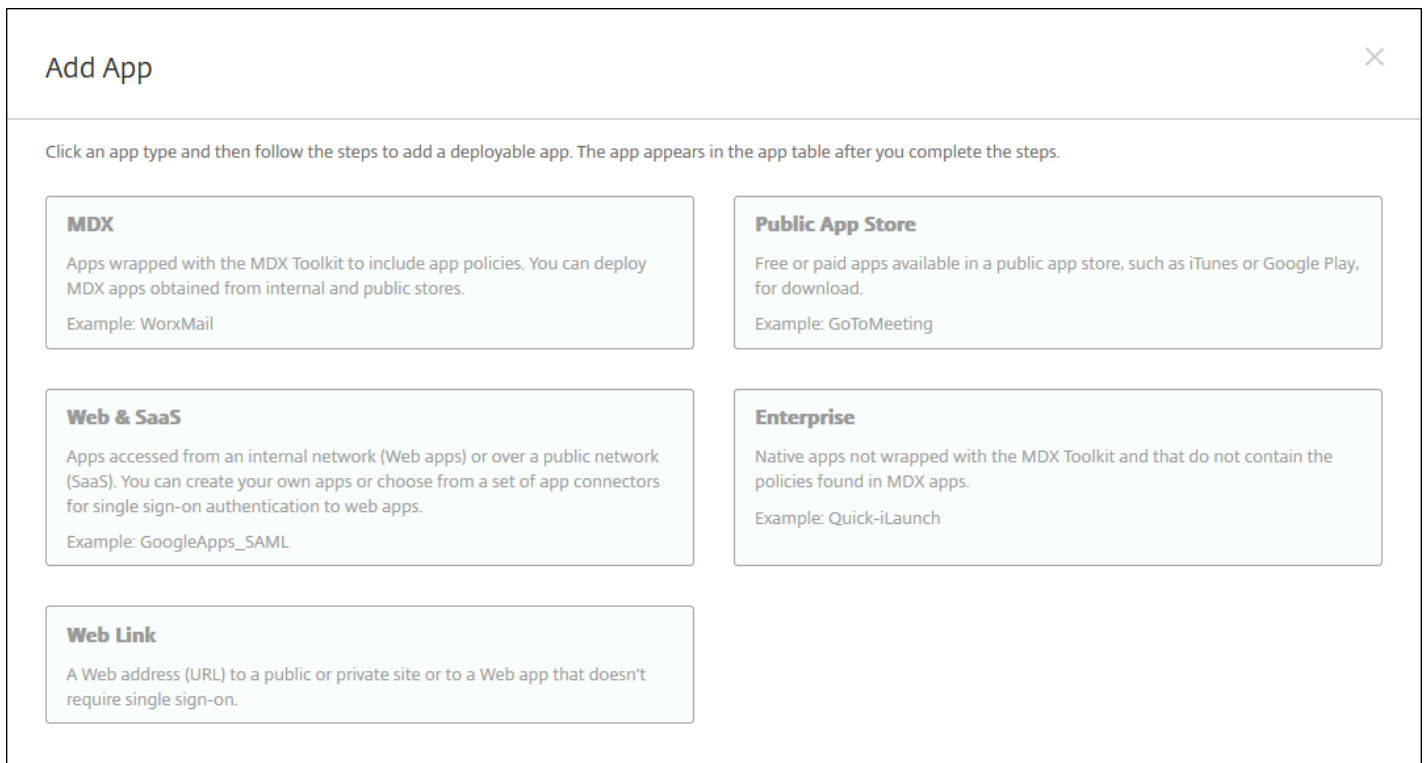

Add App ×

Click an app type and then follow the steps to add a deployable app. The app appears in the app table after you complete the steps.

MDX
Apps wrapped with the MDX Toolkit to include app policies. You can deploy MDX apps obtained from internal and public stores.
Example: WorxMail

Public App Store
Free or paid apps available in a public app store, such as iTunes or Google Play, for download.
Example: GoToMeeting

Web & SaaS
Apps accessed from an internal network (Web apps) or over a public network (SaaS). You can create your own apps or choose from a set of app connectors for single sign-on authentication to web apps.
Example: GoogleApps_SAML

Enterprise
Native apps not wrapped with the MDX Toolkit and that do not contain the policies found in MDX apps.
Example: Quick-iLaunch

Web Link
A Web address (URL) to a public or private site or to a Web app that doesn't require single sign-on.

3. Click **Web & SaaS**. The **App Information** page appears.

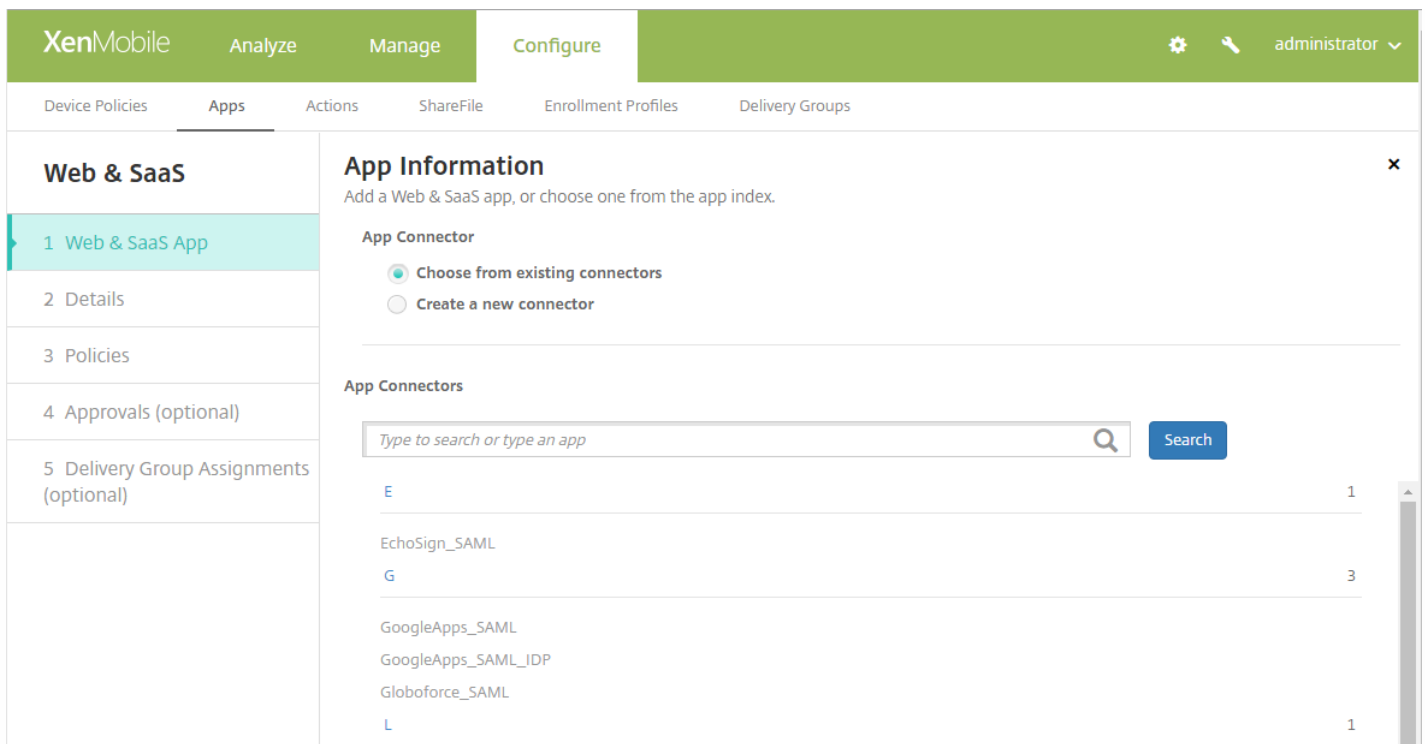

4. Configure an existing or new app connector, as follows.

To configure an existing app connector

In the **App Information** page, **Choose from existing connectors** is already selected, as shown above. Click the connector you want to use in the **App Connectors** list. The app connector information appears.

Configure these settings:

- **App name:** Accept the pre-filled name or type a new name.
- **App description:** Accept the pre-filled description or type one of your own.
- **URL:** Accept the pre-filled URL or type the web address for the app. Depending on the connector you choose, this field may contain a placeholder that you must replace before you can move to the next page.
- **Domain name:** If applicable, type the domain name of the app. This field is required.
- **App is hosted in internal network:** Select whether the app is running on a server in your internal network. If users connect from a remote location to the internal app, they must connect through NetScaler Gateway. Setting this option to **ON** adds the VPN keyword to the app and allows users to connect through NetScaler Gateway. The default is **OFF**.
- **App category:** In the list, click an optional category to apply to the app.
- **User account provisioning:** Select whether to create user accounts for the application. If you use the `Globoforce_SAML` connector, you must enable this option to ensure seamless SSO integration.
- If you enable **User account provisioning**, configure these settings:
 - **Service Account**
 - **User name:** Type the name of the app administrator. This field is required.
 - **Password:** Type the app administrator password. This field is required.
 - **User Account**
 - **When user entitlement ends:** In the list, click the action to take when users are no longer allowed access to the app. The default is `Disable account`. Possible options are:
 - `Disable account`

- Keep account
- Remove account
- **User Name Rule**
 - For each user name rule you want to add, do the following:
 - **User attributes:** In the list, click the user attribute to add to the rule.
 - **Length (characters):** In the list, click the number of characters from the user attribute to use in the user name rule. The default is All.
 - **Rule:** Each user attribute you add is automatically appended to the user name rule.
- **Password Requirement**
 - **Length:** Type the minimum user password length. The default is 8.
- **Password Expiration**
 - **Validity (days):** Type the number of days the password is valid. Valid values are 0-90. The default is 90.
 - **Automatically reset password after it expires:** Select whether to reset the password automatically when it expires. The default is OFF. If you don't enable this field, users can't open the app after their passwords expire.

To configure a new app connector

In the App Information page, select **Create a new connector**. The app connector fields appear.

The screenshot shows the XenMobile interface with the 'Configure' tab active. The 'App Information' page is open, showing options to either choose from existing connectors or create a new one. The 'Create a new connector' option is selected. The form contains the following fields and options:

- Name***: Text input field.
- Description***: Text area.
- Logon URL***: Text input field.
- SAML version**: Radio buttons for 1.1 (selected) and 2.0.
- Entity ID***: Text input field.
- Relay state URL**: Text input field.
- Name ID format**: Radio buttons for Email Address (selected) and Unspecified.
- ACS URL***: Text input field.
- Image**: Radio buttons for Use default (selected) and Upload your own app image.

An **Add** button is located at the bottom of the form.

Configure these settings:

- **Name:** Type a name for the connector. This field is required.
- **Description:** Type a description for the connector. This field is required.
- **Logon URL:** Type, or copy and paste, the URL where users log on to the site. For example, if the app you want to add has a logon page, open a web browser and go to the logon page for the app. For example, it might be <http://www.example.com/logon>. This field is required.
- **SAML version:** Select either **1.1** or **2.0**. The default is **1.1**.
- **Entity ID:** Type the identity for the SAML app.
- **Relay state URL:** Type the web address for the SAML application. The relay state URL is the response URL from the app.
- **Name ID format:** Select either **Email Address** or **Unspecified**. The default is **Email Address**.
- **ACS URL:** Type the Assertion Consumer Service URL of the identity provider or service provider. The ACS URL gives users SSO capability.
- **Image:** Select whether to use the default Citrix image or to upload your own app image. The default is Use default.
 - If you want to upload your own image, select it by clicking **Browse** and navigating to the file location. The file must be a .PNG file. You can't upload a JPEG or GIF file. When you add a custom graphic, you can't change it later.
 - When you're finished, click **Add**. The **Details** page appears.

5. Click **Next**. The **App Policy** page appears.

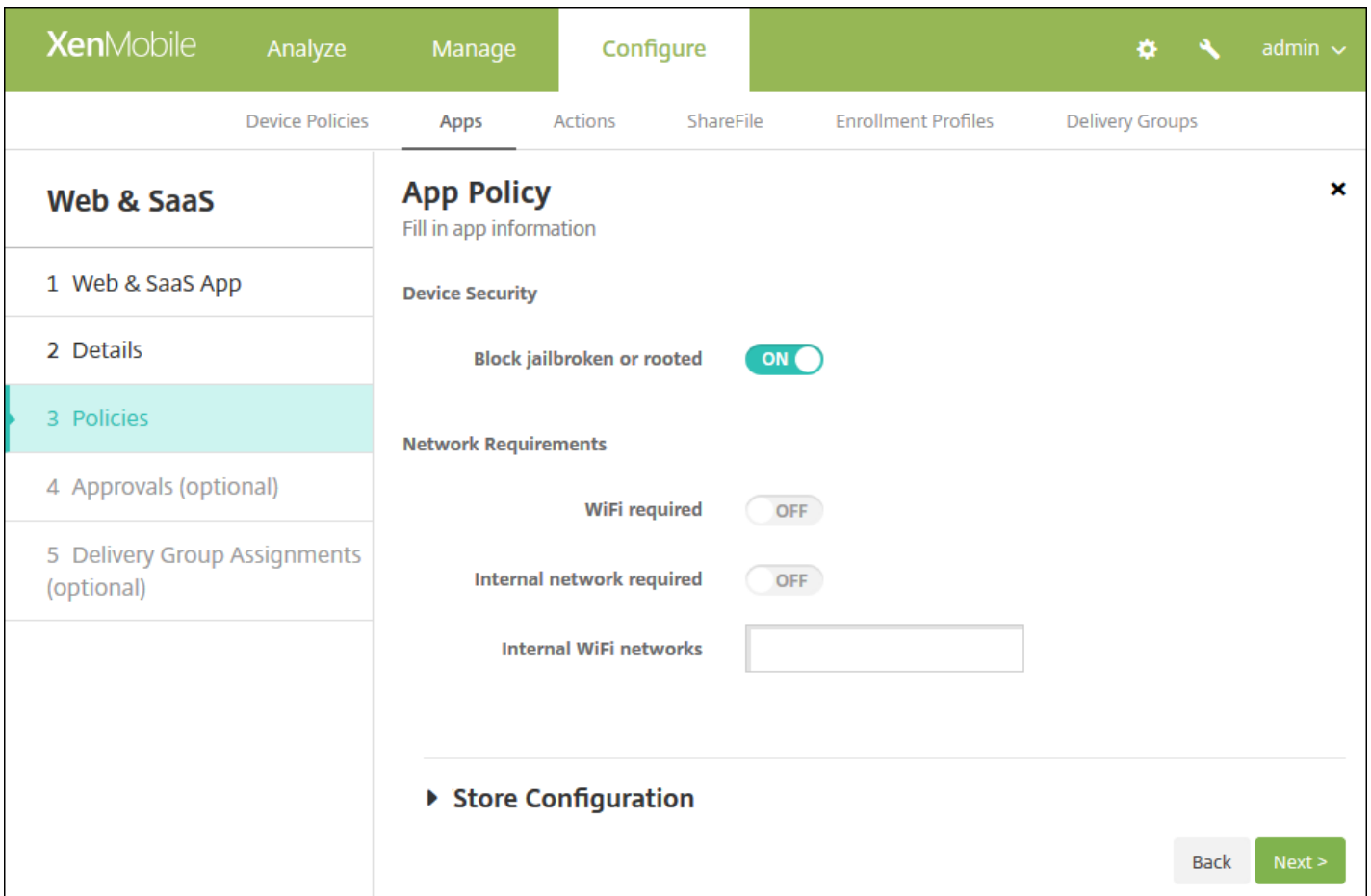

- Configure these settings:
 - **Device Security**
 - **Block jailbroken or rooted:** Select whether to block jailbroken or rooted devices from accessing the app. The default is **ON**.

- **Network Requirements**
 - **WiFi required:** Select whether a WiFi connection is required to run the app. The default is **OFF**.
 - **Internal network required:** Select whether an internal network is required to run the app. The default is **OFF**.
 - **Internal WiFi networks:** If you enabled WiFi required, type the internal WiFi networks to use.

6. Expand XenMobile Store Configuration.

▼ Store Configuration

App FAQ

Add a new FAQ question and answer

App screenshots

Choose File

Choose File

Choose File

Choose File

Choose File

Allow app ratings

Allow app comments

Optionally, you can add an FAQ for the app or screen captures that appear in the XenMobile Store. You can also set whether users can rate or comment on the app.

- Configure these settings:
 - **App FAQ:** Add FAQ questions and answers for the app.
 - **App screenshots:** Add screen captures to help classify the app in the XenMobile Store. The graphic you upload must be a PNG. You cannot upload a GIF or JPEG image.
 - **Allow app ratings:** Select whether to permit a user to rate the app. The default is **ON**.
 - **Allow app comments:** Select whether to permit users to comment about the selected app. The default is **ON**.

7. Click **Next**. The **Approvals** page appears.

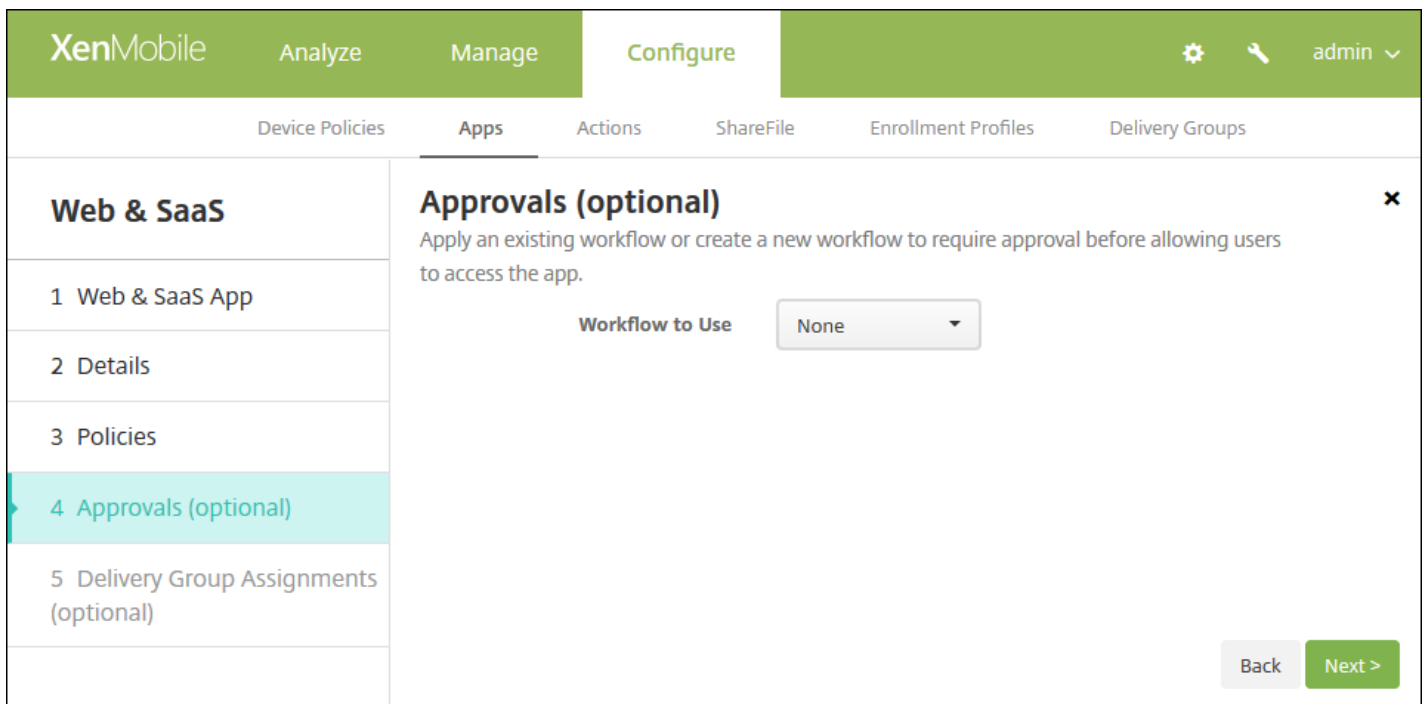

You use workflows when you need approval when creating user accounts. If you don't need to set up approval workflows, you can skip to Step 8.

Configure these settings if you need to assign or create a workflow:

- **Workflow to Use:** In the list, click an existing workflow or click **Create a new workflow**. The default is **None**.
- If you select **Create a new workflow**, configure these settings:
 - **Name:** Type a unique name for the workflow.
 - **Description:** Optionally, type a description for the workflow.
 - **Email Approval Templates:** In the list, select the email approval template to be assigned. When you click the eye icon to the right of this field, a dialog box appears where you can preview the template.
 - **Levels of manager approval:** In the list, select the number of levels of manager approval required for this workflow. The default is **1 level**. Possible options are:
 - Not Needed
 - 1 level
 - 2 levels
 - 3 levels
 - **Select Active Directory domain:** In the list, select the appropriate Active Directory domain to be used for the workflow.
 - **Find additional required approvers:** Type the name of the additional required person in the search field and then click **Search**. Names originate in Active Directory.
 - When the name appears in the field, select the check box next to the name. The name and email address appear in the **Selected additional required approvers** list.
 - To remove a person from the **Selected additional required approvers** list, do one of the following:
 - Click **Search** to see a list of all the persons in the selected domain.
 - Type a full or partial name in the search box, and then click **Search** to limit the search results.
 - Persons in the **Selected additional required approvers** list have check marks next to their name in the search results list. Scroll through the list and clear the check box next to each name you want to remove.

8. Click **Next**. The **Delivery Group Assignment** page appears.

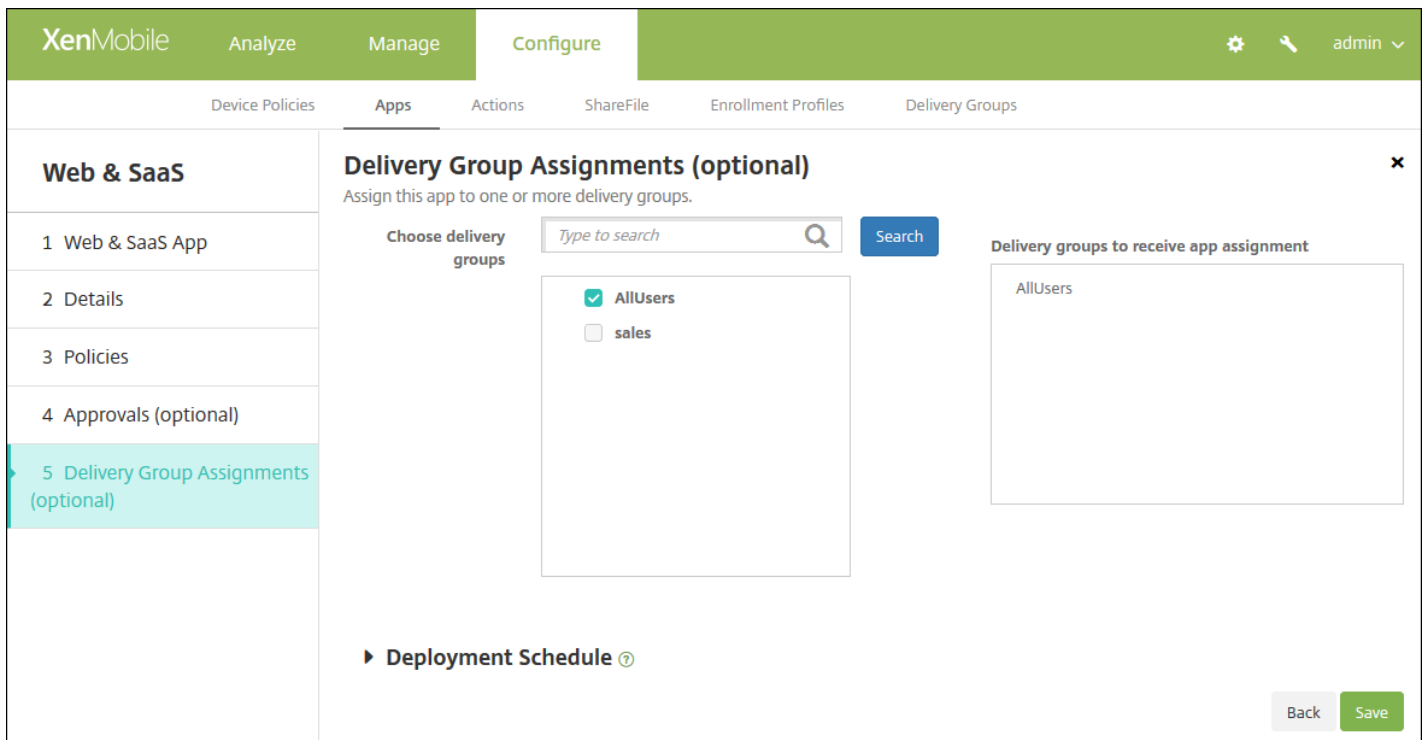

9. Next to **Choose delivery groups**, type to find a delivery group or select a group or groups. The groups you select appear in the **Delivery groups to receive app assignment** list.

10. Expand **Deployment Schedule** and then configure the following settings:

- Next to **Deploy**, click **ON** to schedule deployment or click **OFF** to prevent deployment. The default option is **ON**.
- Next to **Deployment schedule**, click **Now** or **Later**. The default option is **Now**.
- If you click **Later**, click the calendar icon and then select the date and time for deployment.
- Next to **Deployment condition**, click **On every connection** or click **Only when previous deployment has failed**. The default option is **On every connection**.
- Next to **Deploy for always-on connection**, click **ON** or **OFF**. The default option is **OFF**.

Note:

- This option applies when you have configured the scheduling background deployment key in **Settings > Server Properties**. The always-on option is not available for iOS devices.
- The deployment schedule you configure is the same for all platforms. Any changes you make apply to all platforms, except for **Deploy for always on connection**, which does not apply to iOS.

11. Click **Save**.

Add an enterprise app

Enterprise apps in XenMobile represent native apps that are not wrapped with the MDX Toolkit and do not contain the policies associated with MDX apps. You can upload an enterprise app on the **Apps** tab in the XenMobile console. Enterprise

apps support the following platforms (and corresponding file types):

- iOS (.ipa file)
- Android (.apk file)
- Samsung KNOX (.apk file)
- Android for Work (.apk file)
- Windows Phone (.xap or .appx file)
- Windows Tablet (.appx file)
- Windows Mobile/CE (.cab file)

1. In the XenMobile console, click **Configure > Apps**. The **Apps** page opens.

2. Click **Add**. The **Add App** dialog box appears.

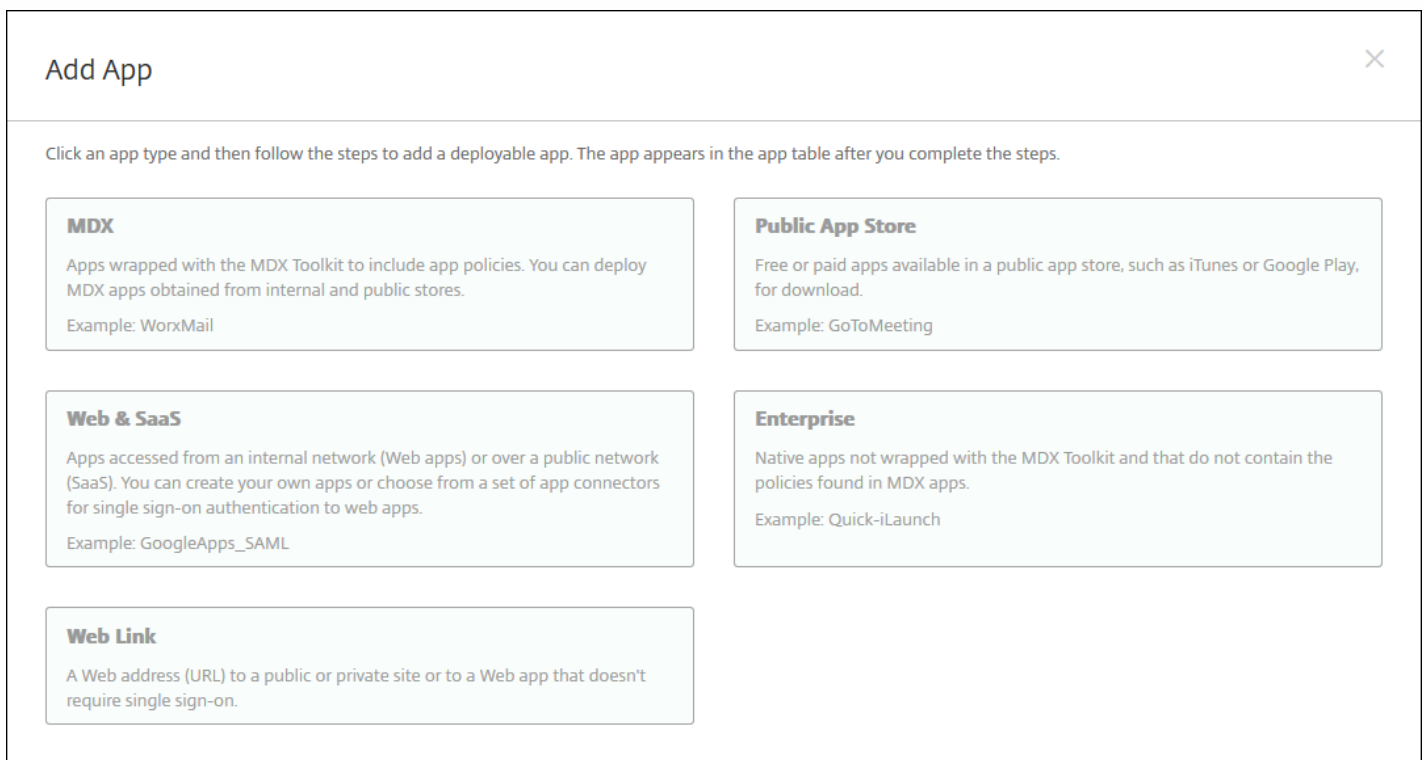

3. Click **Enterprise**. The **App Information** page appears.

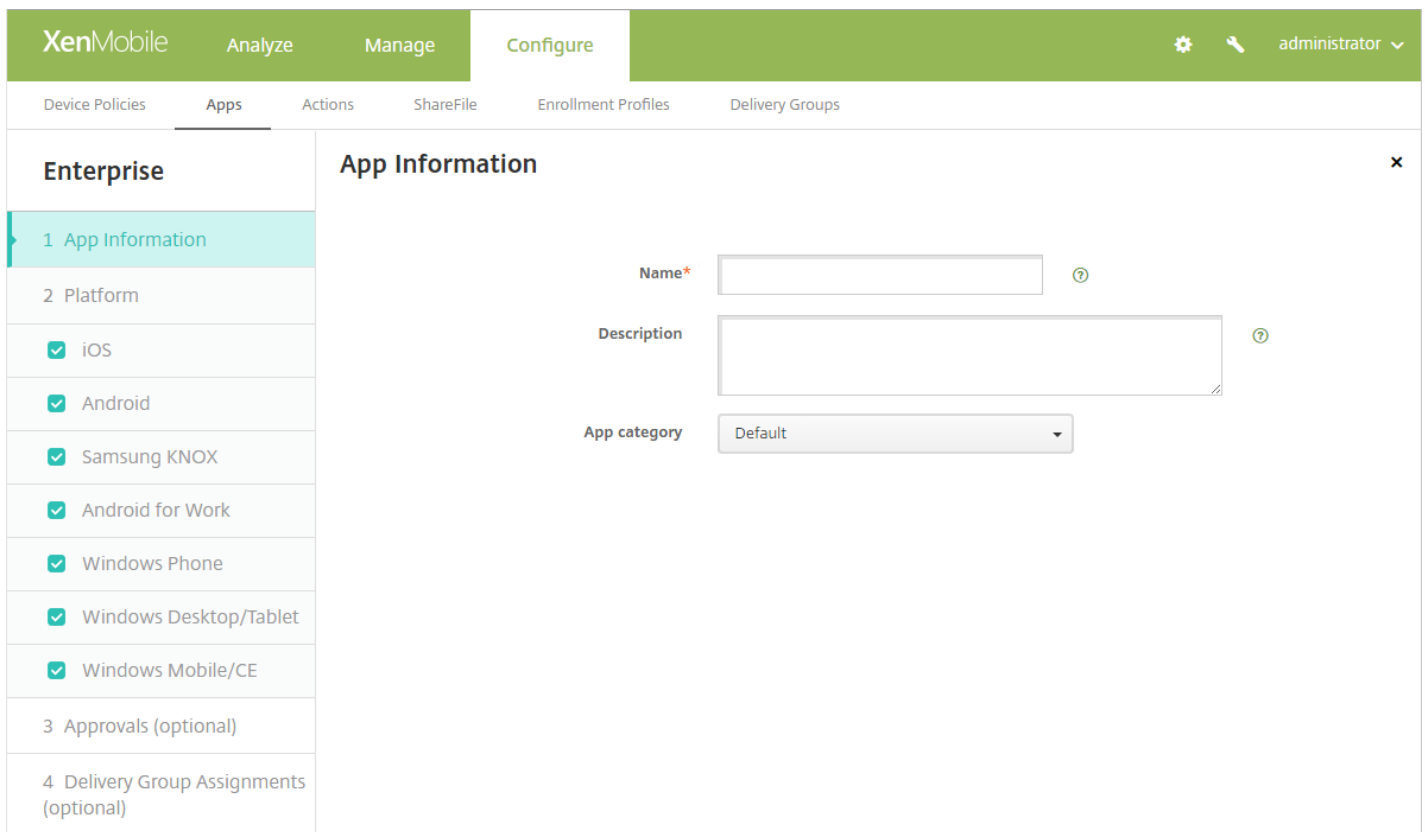

4. On the **App Information** pane, type the following information:

- **Name:** Type a descriptive name for the app. This name is listed under App Name on the Apps table.
- **Description:** Type an optional description of the app.
- **App category:** Optionally, in the list, click the category to which you want to add the app. For more information about app categories, see [Create app categories](#).

5. Click **Next**. The **App Platforms** page appears.

6. Under **Platforms**, select the platforms you want to add. If you are only configuring for one platform, clear the others.

When you finish configuring the settings for a platform, see Step 10 for how to set the platform deployment rules.

7. For each platform you chose, select the file to upload by clicking **Browse** and navigating to the file location.

8. Click **Next**. The app information page for the platform appears.

9. Configure the settings for the platform type, such as:

- **File name:** Optionally, type a new name for the app.
- **App description:** Optionally, type a new description for the app.
- **App version:** You can't change this field.
- **Minimum OS version:** Optionally, type the oldest operating system version that the device can run to use the app.
- **Maximum OS version:** Optionally, type the most recent operating system that the device must run to use the app.
- **Excluded devices:** Optionally, type the manufacturer or models of devices that cannot run the app.
- **Remove app if MDM profile is removed:** Select whether to remove the app from a device when the MDM profile is removed. The default is **ON**.

- **Prevent app data backup:** Select whether to prevent the app from backing up data. The default is **ON**.
- **Force app to be managed:** If you are installing an unmanaged app, select **ON** if you want users on unsupervised devices to be prompted to allow management of the app. If they accept the prompt, the app is managed. This setting applies to iOS 9.x devices.

10. Configure the deployment rules.

11. Expand XenMobile Store Configuration.

▼ Store Configuration

App FAQ

Add a new FAQ question and answer

App screenshots

Choose File

Choose File

Choose File

Choose File

Choose File

Allow app ratings

Allow app comments

Optionally, you can add an FAQ for the app or screen captures that appear in the XenMobile Store. You can also set whether users can rate or comment on the app.

- Configure these settings:
 - **App FAQ:** Add FAQ questions and answers for the app.
 - **App screenshots:** Add screen captures to help classify the app in the XenMobile Store. The graphic you upload must be a PNG. You cannot upload a GIF or JPEG image.
 - **Allow app ratings:** Select whether to permit a user to rate the app. The default is **ON**.
 - **Allow app comments:** Select whether to permit users to comment about the selected app. The default is **ON**.

12. Click **Next**. The **Approvals** page appears.

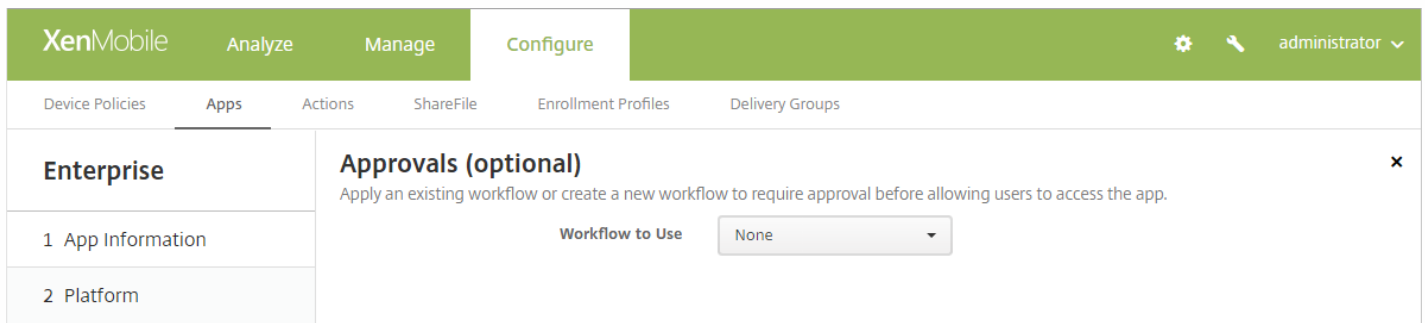

You use workflows when you need approval when creating user accounts. If you don't need to set up approval workflows, you can skip to Step 13.

Configure these settings if you need to assign or create a workflow:

- **Workflow to Use:** In the list, click an existing workflow or click **Create a new workflow**. The default is **None**.
- If you select **Create a new workflow**, configure these settings:
 - **Name:** Type a unique name for the workflow.
 - **Description:** Optionally, type a description for the workflow.
 - **Email Approval Templates:** In the list, select the email approval template to be assigned. When you click the eye icon to the right of this field, a dialog box appears where you can preview the template.
 - **Levels of manager approval:** In the list, select the number of levels of manager approval required for this workflow. The default is **1 level**. Possible options are:
 - Not Needed
 - 1 level
 - 2 levels
 - 3 levels
 - **Select Active Directory domain:** In the list, select the appropriate Active Directory domain to be used for the workflow.
 - **Find additional required approvers:** Type the name of the additional required person in the search field and then click **Search**. Names originate in Active Directory.
 - When the name appears in the field, select the check box next to the name. The name and email address appear in the **Selected additional required approvers** list.
 - To remove a person from the **Selected additional required approvers** list, do one of the following:
 - Click **Search** to see a list of all the persons in the selected domain.
 - Type a full or partial name in the search box, and then click **Search** to limit the search results.
 - Persons in the **Selected additional required approvers** list have check marks next to their name in the search results list. Scroll through the list and clear the check box next to each name you want to remove.

13. Click **Next**. The **Delivery Group Assignment** page appears.

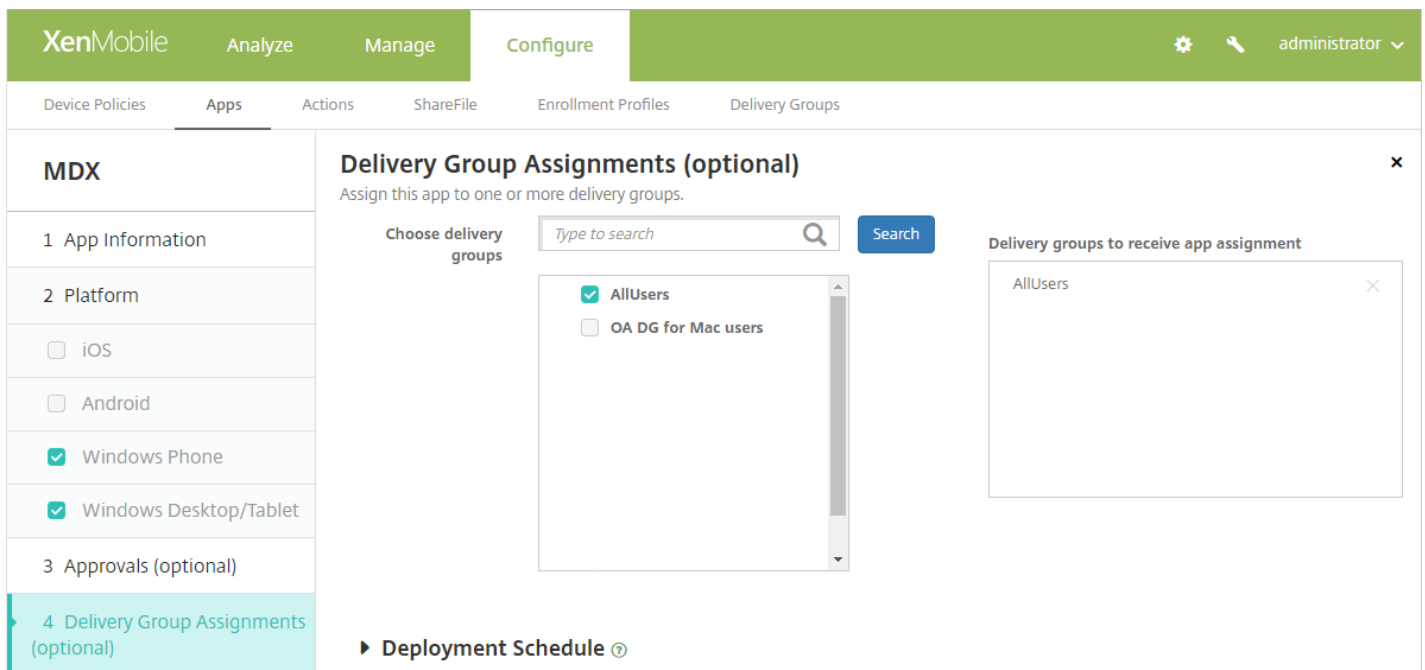

14. Next to **Choose delivery groups**, type to find a delivery group or select a group or groups in the list. The groups you select appear in the **Delivery groups to receive app assignment** list.

15. Expand **Deployment Schedule** and then configure the following settings:

- Next to **Deploy**, click **ON** to schedule deployment or click **OFF** to prevent deployment. The default option is **ON**.
- Next to **Deployment schedule**, click **Now** or **Later**. The default option is **Now**.
- If you click **Later**, click the calendar icon and then select the date and time for deployment.
- Next to **Deployment condition**, click **On every connection** or click **Only when previous deployment has failed**. The default option is **On every connection**.
- Next to **Deploy for always-on connection**, click **ON** or **OFF**. The default option is **OFF**.

Note:

- This option applies when you have configured the scheduling background deployment key in **Settings > Server Properties**. The always-on option is not available for iOS devices.
- The deployment schedule you configure is the same for all platforms. Any changes you make apply to all platforms, except for **Deploy for always on connection**, which does not apply to iOS.

16. Click **Save**.

Add a Web link

In XenMobile, you can establish a web address (URL) to a public or private site, or to a web app that doesn't require single sign-on (SSO).

You can configure web links from the **Apps** tab in the XenMobile console. When you finish configuring the web link, the link appears as a link icon in the list in the **Apps** table. When users log on with Secure Hub, the link appears with the list of available apps and desktops.

To add the link, you provide the following information:

- Name for the link
- Description of the link
- Web address (URL)
- Category
- Role
- Image in .png format (optional)

1. In the XenMobile console, click **Configure > Apps**. The **Apps** page appears.

2. Click **Add**. The **Add App** dialog box appears.

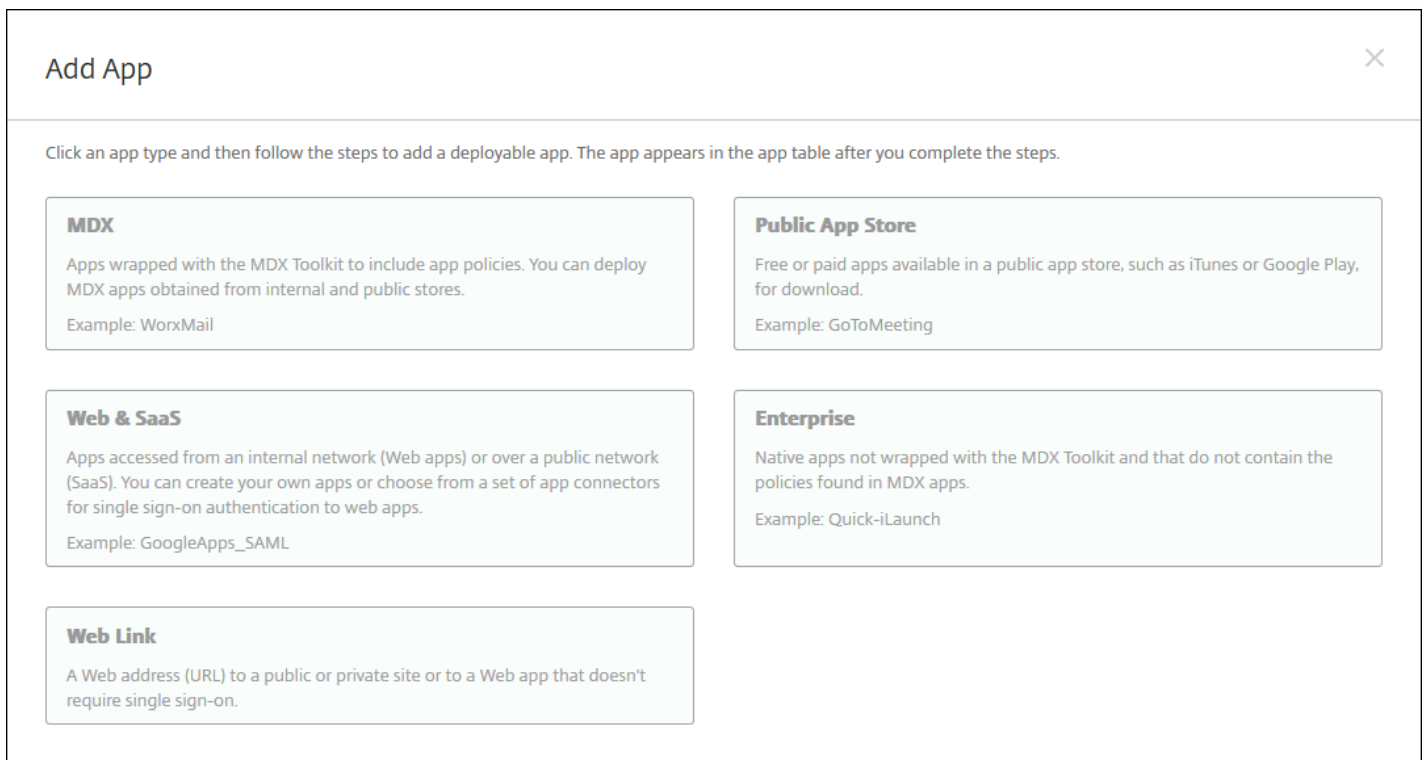

3. Click **Web Link**. The **App Information** page appears.

4. Configure these settings:

- **App name:** Accept the pre-filled name or type a new name.
- **App description:** Accept the pre-filled description or type one of your own.
- **URL:** Accept the pre-filled URL or type the web address for the app. Depending on the connector you choose, this field may contain a placeholder that you must replace before you can move to the next page.
- **App is hosted in internal network:** Select whether the app is running on a server in your internal network. If users connect from a remote location to the internal app, they must connect through NetScaler Gateway. Setting this option to **ON** adds the VPN keyword to the app and allows users to connect through NetScaler Gateway. The default is **OFF**.
- **App category:** In the list, click an optional category to apply to the app.
- **Image:** Select whether to use the default Citrix image or to upload your own app image. The default is Use default.
 - If you want to upload your own image, select it by clicking **Browse** and navigating to the file location. The file must be a .PNG file. You can't upload a JPEG or GIF file. When you add a custom graphic, you can't change it later.

5. Expand **XenMobile Store Configuration**.

▼ **Store Configuration**

App FAQ

Add a new FAQ question and answer

App screenshots

Choose File

Choose File

Choose File

Choose File

Choose File

Choose File

Allow app ratings ON

Allow app comments ON

Optionally, you can add an FAQ for the app or screen captures that appear in the XenMobile Store. You can also set whether users can rate or comment on the app.

- Configure these settings:
 - **App FAQ:** Add FAQ questions and answers for the app.
 - **App screenshots:** Add screen captures to help classify the app in the XenMobile Store. The graphic you upload must be a PNG. You cannot upload a GIF or JPEG image.
 - **Allow app ratings:** Select whether to permit a user to rate the app. The default is **ON**.
 - **Allow app comments:** Select whether to permit users to comment about the selected app. The default is **ON**.

6. Click **Next**. The **Delivery Group Assignment** page appears.

7. Next to **Choose delivery groups**, type to find a delivery group or select a group or groups in the list. The groups you select appear in the **Delivery groups to receive app assignment** list.

8. Expand **Deployment Schedule** and then configure the following settings:

- Next to **Deploy**, click **ON** to schedule deployment or click **OFF** to prevent deployment. The default option is **ON**.
- Next to **Deployment schedule**, click **Now** or **Later**. The default option is **Now**.
- If you click **Later**, click the calendar icon and then select the date and time for deployment.
- Next to **Deployment condition**, click **On every connection** or click **Only when previous deployment has failed**. The default option is **On every connection**.
- Next to **Deploy for always-on connection**, click **ON** or **OFF**. The default option is **OFF**.

Note:

- This option applies when you have configured the scheduling background deployment key in **Settings > Server Properties**. The always-on option is not available for iOS devices.
- The deployment schedule you configure is the same for all platforms. Any changes you make apply to all platforms, except for **Deploy for always on connection**, which does not apply to iOS.

9. Click **Save**.

Enable Microsoft 365 apps

You can open the MDX container to allow Secure Mail, Secure Web, and ShareFile to transfer documents and data to Microsoft Office 365 apps. For details, see [Allowing Secure Interaction with Office 365 Apps](#).

Create and manage workflows

You can use workflows to manage the creation and removal of user accounts. Before you can use a workflow, identify individuals in your organization who have the authority to approve user account requests. Then, you can use the workflow template to create and approve user account requests.



When you set up XenMobile for the first time, you configure workflow email settings, which must be set before you can use workflows. You can change workflow email settings at any time. These settings include the email server, port, email address, and whether the request to create the user account requires approval.

You can configure workflows in two places in XenMobile:

- In the **Workflows** page in the XenMobile console. On the **Workflows** page, you can configure multiple workflows for use with app configurations. When you configure workflows on the **Workflows** page, you can select the workflow when you configure the app.
- When you configure an application connector in the app, you provide a workflow name and then configure the individuals who can approve the user account request.

You can assign up to three levels for manager approval of user accounts. If you need other persons to approve the user account, you can search for and select persons by name or email address. When XenMobile finds the person, you then add them to the workflow. All individuals in the workflow receive emails to approve or deny the new user account.

1. In the XenMobile console, click the gear icon in the upper-right corner of the console. The **Settings** page appears.
2. Click **Workflows**. The **Workflows** page appears.

XenMobile Analyze Manage Configure   admin 

Settings > Workflows



Workflows

Add

<input type="checkbox"/>	Name	Description	Workflow email template	
<input type="checkbox"/>	WF 1		Workflow Approval Request	

Showing 1 - 1 of 1 items

3. Click Add. The Add Workflow page appears.

XenMobile Analyze Manage Configure   admin 

Settings > Workflows > Add Workflow

Add Workflow

Name*

Description

Email Approval Templates Workflow Approval Request 

Levels of manager approval 1 level 

Select Active Directory domain agsag.com 

Find additional required approvers 

Selected additional required approvers

4. Configure these settings:

- **Name:** Type a unique name for the workflow.
- **Description:** Optionally, type a description for the workflow.
- **Email Approval Templates:** In the list, select the email approval template to be assigned. You create email templates in the Notification Templates section under Settings in the XenMobile console. When you click the eye icon to the right of this field, the following dialog box appears.

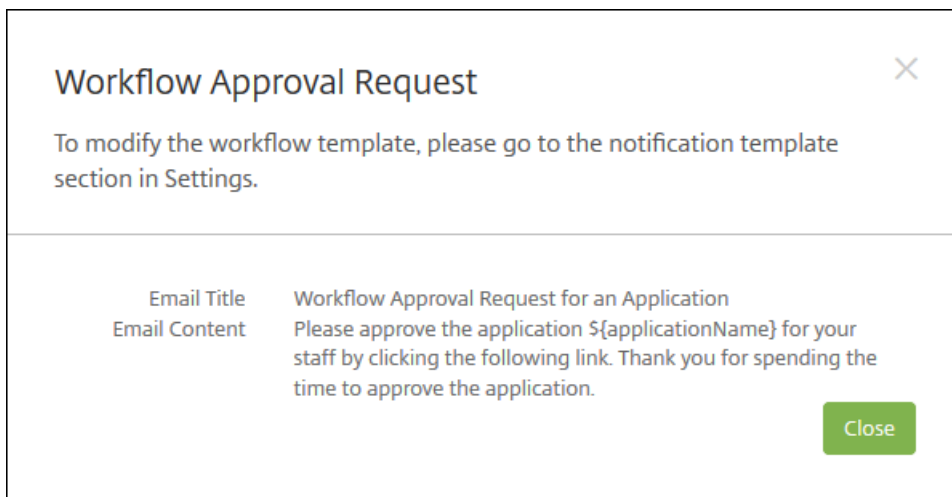

- **Levels of manager approval:** In the list, select the number of levels of manager approval required for this workflow. The default is 1 level. Possible options are:
 - Not Needed
 - 1 level
 - 2 levels
 - 3 levels
 - **Select Active Directory domain:** In the list, select the appropriate Active Directory domain to be used for the workflow.
 - **Find additional required approvers:** Type the name of the additional required person in the search field and then click **Search**. Names originate in Active Directory.
 - When the name appears in the field, select the check box next to the name. The name and email address appear in the **Selected additional required approvers** list.
 - To remove a person from the **Selected additional required approvers** list, do one of the following:
 - Click **Search** to see a list of all the persons in the selected domain.
 - Type a full or partial name in the search box, and then click **Search** to limit the search results.
 - Persons in the **Selected additional required approvers** list have check marks next to their name in the search results list. Scroll through the list and clear the check box next to each name you want to remove.
5. Click **Save**. The created workflow appears on the **Workflows** page.

After you create the workflow, you can view the workflow details, view the apps associated with the workflow, or delete the workflow. You cannot edit a workflow after you create the workflow. If you need a workflow with different approval levels or approvers, you must create another workflow.

To view details and delete a workflow

1. On the **Workflows** page, select a workflow by clicking the row in the table or by selecting the check box next to the workflow.
2. To delete a workflow, click **Delete**. A confirmation dialog box appears. Click **Delete** again.

Important: You cannot undo this operation.

App connector types

Jun 19, 2017

The following table lists the connectors and the types of connectors that are available in XenMobile when you add a Web or SaaS app. You can also add a new connector to XenMobile when you add a Web or SaaS app.

The table indicates whether the connector supports user account management, which lets you create new accounts automatically or by using a workflow.

Connector name	SSO SAML	Supports user account management
EchoSign_SAML	Y	Y
Globoforce_SAML		Note: When using this connector, you must enable User Management for Provisioning to ensure seamless SSO integration.
GoogleApps_SAML	Y	Y
GoogleApps_SAML_IDP	Y	Y
Lynda_SAML	Y	Y
Office365_SAML	Y	Y
Salesforce_SAML	Y	Y
Salesforce_SAML_SP	Y	Y
SandBox_SAML	Y	
SuccessFactors_SAML	Y	
ShareFile_SAML	Y	
ShareFile_SAML_SP	Y	
WebEx_SAML_SP	Y	Y

Upgrade MDX or enterprise apps

Jun 19, 2017

To upgrade an MDX or Enterprise app in XenMobile, disable the app in the XenMobile console, and then upload the new version of the app.

1. In the XenMobile console, click **Configure > Apps**. The **Apps** page appears.

2. For managed devices (devices enrolled in XenMobile for mobile device management), skip to Step 3. For unmanaged devices (devices enrolled in XenMobile for enterprise app management purposes only), do the following:

- In the **Apps** table, select the check box next to the app or click the line containing the app you want to update.
- Click **Disable** in the menu that appears.

The screenshot shows the 'Apps' management interface. At the top, there are buttons for 'Add', 'Category', and 'Export', along with a search bar. Below is a table of apps. The 'Worxmail' app is selected, and a context menu is open over it with the 'Disable' option highlighted. A 'Deployment' summary box is also visible, showing 0 installed, 0 pending, and 0 failed apps. At the bottom, it says 'Showing 1 - 9 of 9 items'.

<input type="checkbox"/>	Icon	App Name	Type	Category	Created On	Last Updated	Disable	▼
<input type="checkbox"/>		Onebug	Web Link	Weblink	10/26/15 1:04 PM	11/6/15 9:14 AM		
<input checked="" type="checkbox"/>		Worxmail	MDX	Worxapps	10/26/15 1:06 PM	11/10/15 3:13 PM		
<input type="checkbox"/>		worxweb	MDX	Worxapps				
<input type="checkbox"/>		Angrybird	Public App Store	Public				
<input type="checkbox"/>		WorxTasks	MDX	Default				
<input type="checkbox"/>		WorxMail2	MDX	MDX				
<input type="checkbox"/>		WorxNotes-iOS	MDX	MDX				
<input type="checkbox"/>		worxweb2	MDX	MDX				
<input type="checkbox"/>		ShareFile1	MDX	MDX				

- Click **Disable** in the confirmation dialog box. *Disabled* appears in the **Disable** column for the app.

<input type="checkbox"/>	Icon	App Name	Type	Category	Created On	Last Updated	Disable	▼
<input type="checkbox"/>		Onebug	Web Link	Weblink	10/26/15 1:04 PM	11/6/15 9:14 AM		
<input type="checkbox"/>		Worxmail	MDX	Worxapps	10/26/15 1:06 PM	11/11/15 8:55 AM	Disabled	

Note: Disabling an app puts the app in maintenance mode. While the app is disabled, users cannot reconnect to the app

after they log off. Disabling an app is an optional setting, but we recommend disabling the app to avoid issues with app functionality. Issues may result from policy updates, for example, or if users request a download at the same time you are uploading the app to XenMobile.

3. In the **Apps** table, click the check box next to the app or click the line containing the app you want to update.

4. Click **Edit** in the menu that appears. The **App Information** page appears with the platforms you originally chose for the app selected.

5. Configure these settings:

- **Name:** Optionally, change the app name.
- **Description:** Optionally, change the app description.
- **App category:** Optionally, change the app category.

6. Click **Next**. The first selected platform page appears. Do the following for each selected platform:

- Choose the replacement file you want to upload by clicking **Upload** and navigating to the file location. The app uploads to XenMobile.
- Optionally, change the app details and policy settings for the platform.
- Optionally, configure deployment rules and XenMobile Store configurations. For information, see "Add an MDX app" in [Add apps](#).

7. Click **Save**. The **Apps** page appears.

8. If you disabled the app in Step 2, do the following:

- In the **Apps** table, click to select the app you updated and then in the menu that appears, click **Enable**.
- In the confirmation dialog box that appears, click **Enable**. Users can now access the app and receive a notification prompting them to upgrade the app.

MDX app policies at a glance

Jun 19, 2017

For a table listing the MDX app policies for iOS, Android, and Windows with notes on restrictions and Citrix recommendations, see [MDX Apps Policies at a Glance](#) in the MDX Toolkit documentation.

XenMobile Store and Citrix Secure Hub branding

Jun 19, 2017

You can set how apps appear in the store and add a logo to brand Secure Hub and the XenMobile Store. These branding features are available for iOS and Android devices.

Note: Before you begin, make sure you have your custom image ready and accessible.

The custom image must meet these requirements:

- The file must be in .png format
- Use a pure white logo or text with a transparent background at 72 dpi.
- The company logo should not exceed this height or width: 170 px x 25 px (1x) and 340 px x 50 px (2x).
- Name the files as Header.png and Header@2x.png.
- Create a .zip file from the files, not a folder with the files inside it.

1. In the XenMobile console, click the gear icon in the upper-right corner. The **Settings** page appears.

The screenshot shows the XenMobile console interface. The top navigation bar is green and contains the following items from left to right: 'XenMobile', 'Dashboard', 'Manage', 'Configure', a gear icon, and 'Admin' with a dropdown arrow. Below the navigation bar, the page title is 'Settings'. The main content area is divided into three columns of settings categories, each with a list of sub-items:

- Certificate Management**
 - Certificates
 - Credential Providers
 - PKI Entities
- Client**
 - Client Branding
 - Client Properties
 - Client Support
- Notifications**
 - Carrier SMS Gateway
 - Notification Server
 - Notification Templates
- Platforms**
 - Android for Work
 - Google Play Credentials
 - iOS Bulk Enrollment
 - iOS Settings
 - Samsung KNOX
- Server**
 - ActiveSync Gateway
 - Enrollment
 - LDAP
 - Licensing
 - Local Users and Groups
 - Mobile Service Provider
 - NetScaler Gateway
 - Network Access Control
 - Release Management
 - Role-Based Access Control
 - Server Properties
 - SysLog
 - Workflows
 - XenApp/XenDesktop

On the right side, there is a 'Frequently Accessed' sidebar with the following items:

- Certificates
- Enrollment
- Licensing
- Local Users and Groups
- Role-Based Access Control
- Release Management

2. Under **Client**, click **Client Branding**. The **Client Branding** page appears.

XenMobile Analyze Manage Configure admin

Settings > Client Branding

Client Branding

You can set the way apps appear in the store and add a logo to brand Secure Hub on mobile devices.

Store name* ?

Default store view

Category

A-Z

Device

Phone

Tablet

Branding file

Note:

- The file must be in .png format (pure white logo/text with transparent background at 72 dpi).
- The company logo should not exceed this height or width: 170px x 25px (1x) + 340px x 50px (2x).
- Files should be named as Header.png and Header@2x.png.

A .zip file should be created from the files, not a folder with the files inside of it.

Configure the following settings:

- **Store name:** The store name appears on the in the user's account information. Changing the name also changes the URL used to access store services. You typically do not need to change the default name.
- **Default store view:** Select either **Category** or **A-Z**. The default is **A-Z**
- **Device option:** Select either **Phone** or **Tablet**. The default is **Phone**.
- **Branding file:** Select an image or .zip file of images to use for branding by, clicking **Browse** and navigating to the file's location.

3. Click **Save**.

To deploy this package to users' devices, you need to create a deployment package and deploy the package to users' devices.

Citrix Launcher

Jun 19, 2017

Citrix Launcher lets you customize the user experience for Android devices deployed by XenMobile. The minimum Android version supported for Secure Hub management of Citrix Launcher is Android 4.0.3. You can add the **Launcher Configuration Policy** to control these Citrix Launcher features:

- Manage Android devices so that users can access only the apps that you specify.
- Optionally specify a custom logo image for the Citrix Launcher icon and a custom background image for Citrix Launcher.
- Specify a password that users must enter to exit the launcher.

While Citrix Launcher enables you to apply those device-level restrictions, the launcher grants users built-in access to device settings such as Wi-Fi settings, Bluetooth settings, and device passcode settings. Citrix Launcher isn't intended as an extra layer of security over what the device platform already provides.

To provide Citrix Launcher to Android devices, follow these general steps.

1. Download the Citrix Launcher app from the [Citrix XenMobile downloads](#) page for your XenMobile edition. The file name is CitrixLauncher.apk. The file is ready for uploading into XenMobile and doesn't require wrapping.
2. Add the device policy **Launcher Configuration Policy**: Go to **Configure > Device Policies**, click **Add**, and in the **Add a New Policy** dialog box, start typing **Launcher**. For more information, see [Launcher Configuration Policy](#).

The screenshot shows the XenMobile management console interface. The top navigation bar includes 'XenMobile', 'Analyze', 'Manage', and 'Configure'. Below this, a secondary navigation bar lists 'Device Policies', 'Apps', 'Actions', 'ShareFile', 'Enrollment Profiles', and 'Delivery Groups'. The main content area is titled 'Launcher Configuration Policy' and contains a sidebar with '1 Policy Info', '2 Platforms', '3 Android', and '3 Assignment'. The 'Policy Information' section includes a description: 'This policy lets you define a configuration of an Android device launcher.' Under 'Launcher app configuration', there are two sections: 'Define a logo image' with a toggle set to 'ON', a text input for 'Logo image' containing 'ribbon.png', and a 'Browse' button; and 'Define a background image' with a toggle set to 'ON', an empty text input for 'Background image', and a 'Browse' button. Below this is an 'Allowed apps' table with columns for 'App name', 'Package Name*', and an 'Add' button. The table contains one row with 'test' in the 'App name' column and 'test.com' in the 'Package Name*' column. A 'Password' input field is located below the table. At the bottom right, there are 'Back' and 'Next >' buttons.

App name	Package Name*	Add
test	test.com	

3. Add the Citrix Launcher app to XenMobile as an enterprise app. In **Configure > Apps**, click **Add** and then click **Enterprise**. For more information, see [Add an enterprise app](#).

Add App ×

Click an app type and then follow the steps to add a deployable app. The app appears in the app table after you complete the steps.

MDX

Apps wrapped with the MDX Toolkit to include app policies. You can deploy MDX apps obtained from internal and public stores.

Example: WorxMail

Public App Store

Free or paid apps available in a public app store, such as iTunes or Google Play, for download.

Example: GoToMeeting

Web & SaaS

Apps accessed from an internal network (Web apps) or over a public network (SaaS). You can create your own apps or choose from a set of app connectors for single sign-on authentication to web apps.

Example: GoogleApps_SAML

Enterprise

Native apps not wrapped with the MDX Toolkit and that do not contain the policies found in MDX apps.

Example: Quick-iLaunch

Web Link

A Web address (URL) to a public or private site or to a Web app that doesn't require single sign-on.

4. Create a Delivery Group for Citrix Launcher with the following configuration in **Configure > Delivery groups**:

- On the **Policies** page, add the **Launcher Configuration Policy**.
- On the **Apps** page, drag **Citrix Launcher** to **Required Apps**.
- On the **Summary** page, click **Deployment Order** and ensure that the **Citrix Launcher** app precedes the **Launcher Configuration** policy.

Deployment Order ×

Change the deployment order by dragging the policies, apps and actions into position.

Citrix Launcher

Launcher Configuration

Cancel Save

For more information, see [Deploy resources](#).

When users open apps from Citrix Launcher, when they open the apps again through the task switcher, the apps do not retain their previous state. [Found in build 1.1.2] [CXM-33035, #686413]

iOS Volume Purchase Program

Jun 29, 2017

You can manage iOS app licensing by using the Apple iOS Volume Purchase Program (VPP). The VPP solution simplifies the process to find, buy, and distribute apps and other data in bulk for an organization.

With VPP, you can use XenMobile to distribute public app store apps. VPP is not supported for XenMobile Apps or for apps wrapped by using the MDX Toolkit. Although you can distribute the XenMobile public store apps with VPP, the deployment is not optimal. Further enhancements to the XenMobile Server and the Secure Hub store are required to address the limitations. For a list of known issues with deploying the XenMobile public store apps via VPP and potential workarounds, see this article in the Citrix [knowledge center](#).

With VPP, you can distribute the applicable apps directly to your devices. Or, you assign content to your users by using redeemable codes. You configure settings specific to the iOS VPP in XenMobile.

XenMobile periodically reimports VPP licenses from Apple to ensure that the licenses reflect all changes. Such changes include when you manually delete an imported app from VPP. By default, XenMobile refreshes the VPP license baseline a minimum of every 720 minutes. You can change the baseline interval through the server property, VPP baseline interval (vpp.baseline). For information, see [Server properties](#).

This article focuses on using VPP with managed licenses, which enables you to use XenMobile to distribute apps. If you currently use redemption codes and want to change to managed distribution, see this Apple Support document: [Migrate from redemption codes to managed distribution with the Volume Purchase Program](#).

For information about the iOS VPP, see <http://www.apple.com/business/vpp/>. To enroll in VPP, go to <https://deploy.apple.com/qforms/open/register/index/avs>. To access your VPP store in iTunes, go to <https://vpp.itunes.apple.com/?l=en>.

After you save these iOS VPP settings in XenMobile, the purchased apps appear on the **Configure > Apps** page in the XenMobile console.

1. In the XenMobile console, click the gear icon in the upper-right corner. The **Settings** page appears.
2. Under **Platform**, click **iOS Settings**. The **iOS Settings** configuration page appears.

Settings > iOS Settings

iOS Settings

Configure these iOS-specific settings. When saved and validated, the Volume Purchase Program (VPP) apps are added to the table on the Apps tab.

Store user password in Secure Hub ⓘ

User property for VPP country mapping ⓘ

VPP Accounts

Add

<input type="checkbox"/>	Name	Suffix	Organization	Country	Expiration Date	User Login
<input type="checkbox"/>	VPP	VPP	CITRIX SYSTEMS, INC.	United States	04/12/2017 02:57:32 pm	TestAccount@outlook.com

6. Click **Save** to save the iOS settings.

A message appears stating that XenMobile adds the apps to the list on the **Configure > Apps** page. On that page, notice that the app names from your VPP account include the suffix you provided in the preceding configuration.

You can now configure the VPP app settings and then tune your delivery group and device policy settings for VPP apps. After you complete those configurations, users can enroll their devices. The following notes provide considerations for those processes.

- When configuring VPP app settings (**Configure > Apps**), enable **Force license association to device**. An advantage of using Apple VPP and DEP with supervised devices: The ability to use XenMobile to assign the app at the device (rather than user) level. As a result, you don't have to use an Apple ID device. Also, users don't receive an invitation to join the VPP program. Users can also download the apps without signing into their iTunes account.

The screenshot shows the XenMobile web interface. The top navigation bar includes 'XenMobile', 'Analyze', 'Manage', and 'Configure'. The 'Configure' tab is active, and the 'Apps' sub-tab is selected. The main content area is titled 'iPhone App Settings' and shows configuration options for the 'GoToMeeting' app. The 'Force license association to device' toggle is highlighted with a red box and is currently turned 'ON'. Other visible settings include 'Name' (GoToMeeting), 'Description', 'Version' (6.6.5.1134), 'Image', 'Paid app' (OFF), 'Remove app if MDM profile is removed' (ON), 'Prevent app data backup' (ON), and 'Force app to be managed' (ON). A 'Check for Updates' button is also present. The left sidebar shows a 'Public App Store' with categories like 'App Information', 'Platform', and 'Approvals (optional)'. The 'Platform' section has 'iPhone', 'iPad', and 'Google Play' checked. At the bottom right, there are 'Back' and 'Next >' buttons.

To view the VPP info for that app, expand **Volume Purchase Program**. Notice in the **VPP ID Assignment** table, the license is associated with a device. The device serial number appears in the **Associated Device** column. If the user removes the token and then imports it again, the word **Hidden** appears instead of the serial number, due to Apple privacy restrictions.

XenMobile Analyze Manage **Configure** administrator

Device Policies **Apps** Actions ShareFile Enrollment Profiles Delivery Groups

Public App Store

- 1 App Information
- 2 Platform
 - iPhone
 - iPad
 - Google Play
 - Android for Work
 - Windows Desktop/Tablet
 - Windows Phone
- 3 Approvals (optional)
- 4 Delivery Group Assignments (optional)

Remove app if MDM profile is removed

Prevent app data backup

Force app to be managed ?

Force license association to device

► Deployment Rules

► Store Configuration

▼ Volume Purchase Program

VPP ID Assignment License Usage: 2 of 2

Disassociate

<input type="checkbox"/>	License ID	Usage Status	Associated User	Associated Device
<input type="checkbox"/>	82684302	Used		
<input type="checkbox"/>	82684301	Used		F9FMW440FCM5

Showing 1 - 2 of 2 items

VPP License Keys

Import

To disassociate a license, click the row for the license and then click Disassociate.

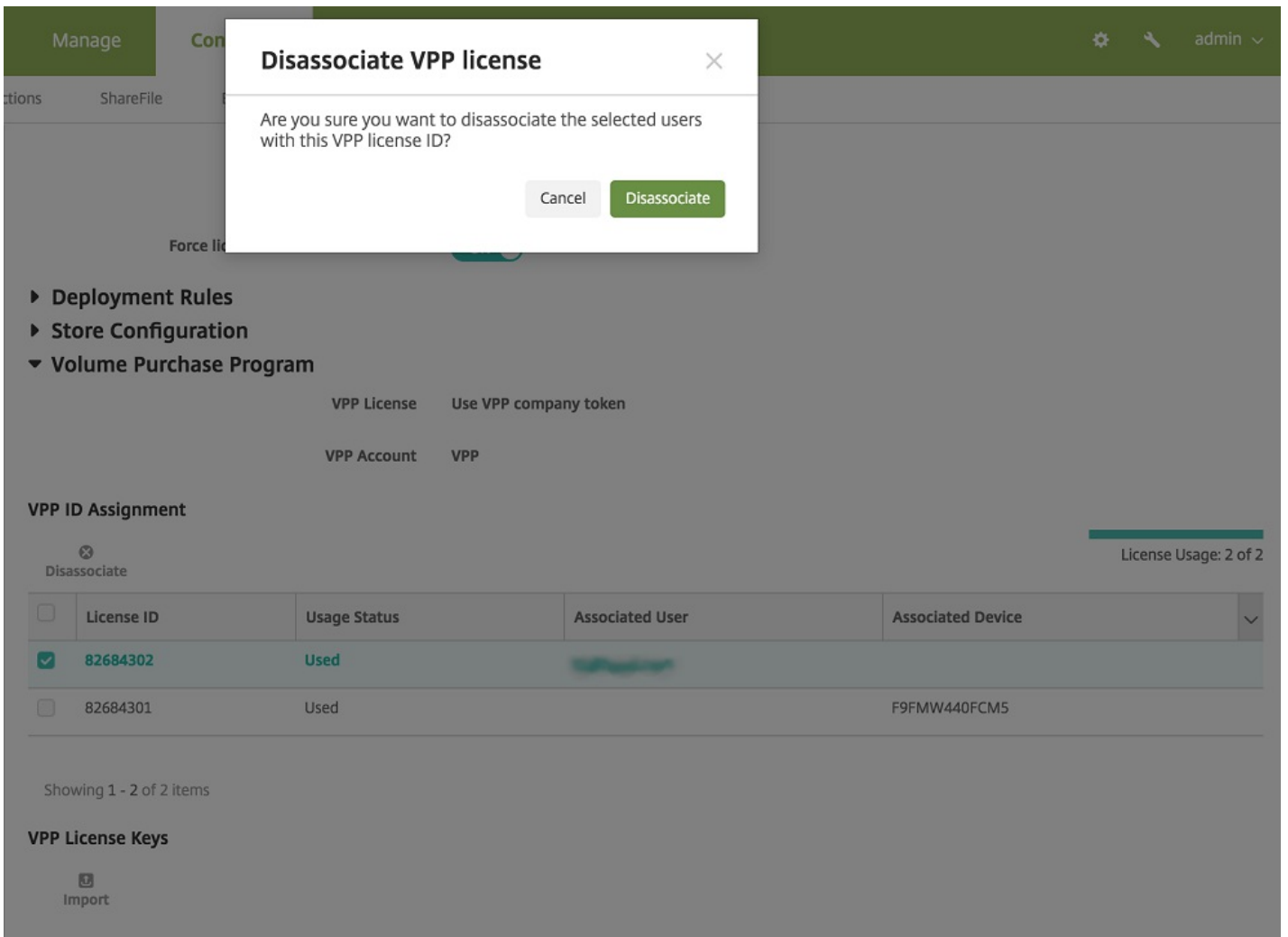

If you associate VPP licenses with users, XenMobile integrates users into your VPP account and associates their iTunes ID with the VPP account. The iTunes ID of users is never visible to your company or to the XenMobile Server. Apple transparently creates the association to retain user privacy. You can retire a user from the VPP program, to disassociate all licenses from the user account. To retire a user, go to **Manage > Devices**.

XenMobile Analyze **Manage** Configure admin

Devices Users Enrollment Invitations

Device details

- General
- Properties
- User Properties**
- Assigned Policies
- Apps
- Actions
- Delivery Groups
- iOS Profiles
- iOS Provisioning Profiles
- Certificates
- Connections
- MDM Status

User Properties

User name

Password

Role*

Membership local\MSP [Manage Groups](#)

VPP Accounts VPP [Retire](#)

[Back](#) [Next >](#)

- When you assign an app to a delivery group, by default XenMobile identifies the app as an optional app. To ensure that XenMobile deploys an app to devices, go to **Configure > Delivery Groups**. On the **Apps** page, move the app to the **Required Apps** list.
- When an update for a public app store app is available: When VPP pushes the app, the app doesn't automatically update on devices until you check for updates and apply them. To push an update for Secure Hub, when assigned to device and not to a user, do the following. In **Configure > Apps**, on a platform page, click **Check for Updates** and apply the update.

XenMobile Analyze Manage **Configure** administrator

Device Policies **Apps** Actions ShareFile Enrollment Profiles Delivery Groups

Public App Store

- 1 App Information
- 2 Platform
 - iPhone
 - iPad
 - Google Play
 - Android for Work
 - Windows Desktop/Tablet
 - Windows Phone
- 3 Approvals (optional)
- 4 Delivery Group Assignments (optional)

iPhone App Settings

Type an app name or keyword in the field and search for your desired app. When you click your app in the results, you can configure how the app appears in the store.

App Details

Name*

Description*

Version Check for Updates

Image 

Paid app OFF

Remove app if MDM profile is removed ON

Prevent app data backup ON

Force app to be managed ON ⓘ

Force license association to device ON

▶ Deployment Rules
 ▶ Store Configuration
 ▶ Volume Purchase Program

Back Next >

XenApp and XenDesktop through Citrix Secure Hub

Jun 19, 2017

XenMobile can collect apps from XenApp and XenDesktop and make them available to mobile device users in the XenMobile Store. Users subscribe to the apps directly inside XenMobile Store and launch them from Secure Hub. Citrix Receiver must be installed on users' devices to launch the apps, but it does not need to be configured.

To configure this setting, you need the fully qualified domain name (FQDN) or IP address and port number for the Web Interface site or StoreFront.

1. In the XenMobile web console, click the gear icon in the upper-right corner. The **Settings** page appears.
2. Click **XenApp/XenDesktop**. The **XenApp/XenDesktop** page appears.

The screenshot shows the XenMobile web console interface. At the top is a green navigation bar with 'XenMobile' and tabs for 'Analyze', 'Manage', and 'Configure'. Below the navigation bar, the breadcrumb 'Settings > XenApp/XenDesktop' is visible. The main heading is 'XenApp/XenDesktop' with a sub-heading 'Allows users to add XenApp and XenDesktop through Secure Hub.' The configuration form includes the following fields and controls:

- Host***: Text input field containing 'example.com.net'
- Port***: Text input field containing '80'
- Relative Path***: Text input field containing '/Citrix/StoreAG3/PNAgent/config.xml'
- Use HTTPS**: Toggle switch set to 'OFF'
- Test Connection**: A green button with a white border.
- Connection succeeded**: A green checkmark icon followed by the text 'Connection succeeded'.

3. Configure these settings:

- **Host**: Type the fully qualified domain name (FQDN) or IP address for the Web Interface site or StoreFront.
- **Port**: Type the port number for the Web Interface site or StoreFront. The default is 80.
- **Relative Path**: Type the path. For example, /Citrix/PNAgent/config.xml
- **Use HTTPS**: Select whether to enable secure authentication between the Web Interface site or StoreFront and the client device. The default is **OFF**.

4. Click **Test Connection** to verify that XenMobile can connect to the specified XenApp and XenDesktop server.

5. Click **Save**.

ShareFile use with XenMobile

Jun 19, 2017

XenMobile has two options for integrating with ShareFile: ShareFile Enterprise and StorageZone Connectors. Integration with ShareFile Enterprise or StorageZone Connectors requires XenMobile Enterprise Edition.

ShareFile Enterprise

If you have XenMobile Enterprise Edition, you can configure XenMobile to provide access to your ShareFile Enterprise account. That configuration:

- Gives mobile users access to the full ShareFile feature set, such as file sharing, file sync, and StorageZone Connectors.
- Can provide ShareFile with single sign-on authentication of XenMobile App users, AD-based user account provisioning, and comprehensive access control policies.
- Provides ShareFile configuration, service level monitoring, and license usage monitoring through the XenMobile console.

For more information about configuring XenMobile for ShareFile Enterprise, see [SAML for single sign-on with ShareFile](#).

StorageZone Connectors

You can configure XenMobile to provide access only to StorageZone Connectors that you create through the XenMobile console. That configuration:

- Provides secure mobile access to existing on-premises storage repositories, such as SharePoint sites and network file shares.
- Doesn't require that you set up a ShareFile subdomain, provision users to ShareFile, or host ShareFile data.
- Provides users with mobile access to data through the ShareFile XenMobile Apps for iOS and Android. Users can edit Microsoft Office documents. Users can also preview and annotate Adobe PDF files from mobile devices.
- Complies with security restrictions against leaking user information outside of the corporate network.
- Provides simple setup of StorageZone Connectors through the XenMobile console. If you later decide to use the full ShareFile functionality with XenMobile, you can change the configuration in the XenMobile console.
- Requires XenMobile Enterprise Edition.

For a XenMobile integration with StorageZone Connectors only:

- ShareFile uses your single sign-on configuration to NetScaler Gateway to authenticate with StorageZones Controller.
- XenMobile doesn't authenticate through SAML because the ShareFile control plane isn't used.

The following diagram shows the high-level architecture for XenMobile use with StorageZone Connectors.

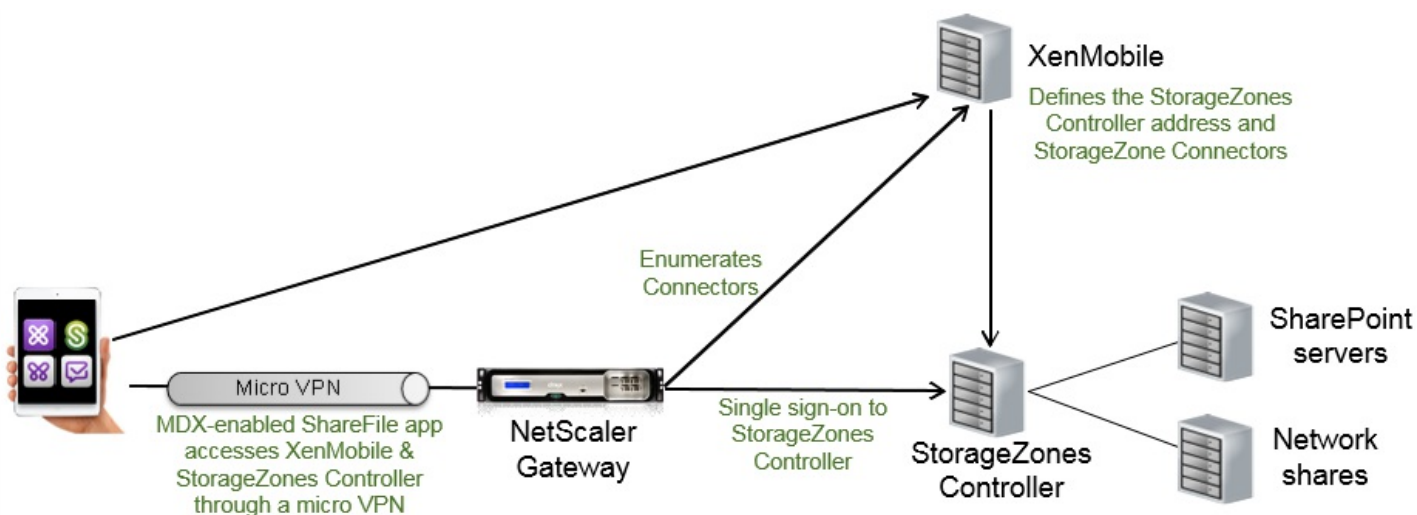

- Minimum component versions:
 - XenMobile Server 10.5 (on-premises)
 - ShareFile for iOS (MDX) 5.3
 - ShareFile for Android (MDX) 5.3
 - ShareFile StorageZones Controller 5.0

This article contains instructions for how to configure ShareFile StorageZones Controller 5.0

- Ensure that the server to run StorageZones Controller meets the system requirements. For requirements, see the following sections in "System requirements" in the ShareFile StorageZones Controller documentation:
 - [StorageZones Controller](#)
 - [StorageZone Connector for SharePoint](#)
 - [StorageZone Connector for Network File Shares](#)

The requirements for StorageZones for ShareFile Data and for Restricted StorageZones don't apply to a XenMobile integration with StorageZone Connectors only.

XenMobile doesn't support Documentum connectors.

- To run PowerShell scripts:
 - Run the scripts in the 32-bit (x86) version of PowerShell.

Complete the following tasks, in the order presented, to install and set up StorageZones Controller. These steps are specific to XenMobile integration with StorageZone Connectors only. Some of these articles are in the StorageZones Controller documentation.

1. [Configure NetScaler for StorageZones Controller](#)

You can use NetScaler as a DMZ proxy for StorageZones Controller.

2. [Install an SSL certificate](#)

A StorageZones Controller that hosts standard zones requires an SSL certificate. A StorageZones Controller that

hosts restricted zones and uses an internal address doesn't require an SSL certificate.

3. Prepare your server

IIS and ASP.NET setup is required for StorageZone Connectors.

4. Install StorageZones Controller

5. Prepare StorageZones Controller for use with StorageZone Connectors-only

6. Specify a proxy server for StorageZones

The StorageZones Controllers console enables you to specify a proxy server for StorageZones Controllers. You can also specify a proxy server using other methods.

7. Configure the domain controller to trust the StorageZones Controller for delegation

Configure the domain controller to support NTLM or Kerberos authentication on network shares or SharePoint sites.

8. Join a secondary StorageZones Controller to a StorageZone

To configure a StorageZone for high availability, connect at least two StorageZones Controllers to it.

1. Download and install the StorageZones Controller software:

- a. From the ShareFile download page at <http://www.citrix.com/downloads/sharefile.html>, log on and download the latest StorageZones Controller installer.
- b. Installing StorageZones Controller changes the default website on the server to the installation path of the controller. Enable **Anonymous Authentication** on the default website.

2. On the server where you want to install StorageZones Controller, run StorageCenter.msi.

The ShareFile StorageZones Controller Setup wizard starts.

3. Respond to the prompts:

- In the **Destination Folder** page, if Internet Information Services (IIS) is installed in the default location, leave the defaults. If not, browse to the IIS installation location.
- When installation is complete, clear the check box for **Launch StorageZones Controller Configuration Page** and then click **Finish**.

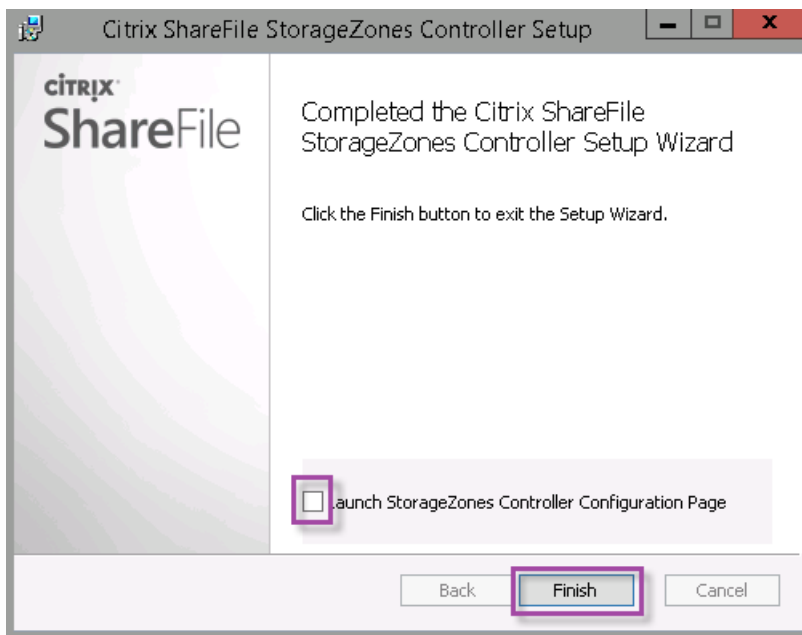

4. When prompted, restart the StorageZones Controller.

5. To test that the installation was successful, navigate to <http://localhost/>. If the installation is successful, the ShareFile logo appears.

If the ShareFile logo does not appear, clear the browser cache and try again.

Important

If you plan to clone the StorageZones Controller, capture the disk image before you proceed with configuring the StorageZones Controller.

For an integration only with StorageZone Connectors, you don't use the StorageZones Controller administrative console. That interface requires a ShareFile administrator account, which isn't necessary for this solution. As a result, you run a PowerShell script to prepare the StorageZones Controller for use without the ShareFile control plane. The script does the following:

- Registers the current StorageZones Controller as a primary StorageZones Controller. You can later join secondary StorageZones Controllers to the primary controller.
- Creates a zone and sets the passphrase for it.

1. From your StorageZone Controller server, download the PsExec tool: Navigate to Microsoft [Windows Sysinternals](https://docs.microsoft.com/en-us/sysinternals/) and then click **Download PsTools**. Extract the tool to the root of the C drive.

Windows Sysinternals

Home Learn **Downloads** Community

Windows Sysinternals > Downloads > Process Utilities > PsExec

Utilities

- Sysinternals Suite
- Utilities Index

- File and Disk Utilities
- Networking Utilities

PsExec v2.11

By Mark Russinovich

Published: May 2, 2014

 **Download PsTools**
(1,648 KB)

2. Download SfConfig.zip: Navigate to <https://labs.sharefile.com/d-sf083d50048a4e408> on the ShareFile Labs site and click **Download**.

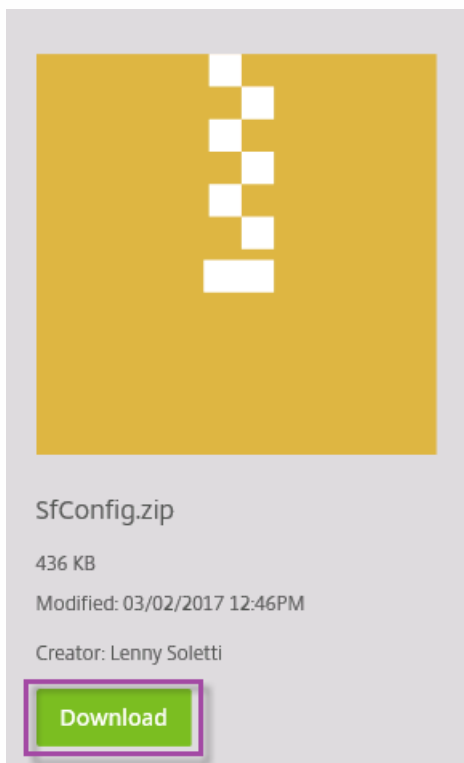

The image shows a file card for 'SfConfig.zip' on the ShareFile Labs website. The card features a yellow square with a white checkered pattern. Below the square, the file name 'SfConfig.zip' is displayed, followed by its size '436 KB', the modification date 'Modified: 03/02/2017 12:46PM', and the creator 'Creator: Lenny Soletti'. At the bottom of the card, there is a green 'Download' button with a white border, which is highlighted with a purple box.

3. Save SfConfig.zip to C:\inetpub\wwwroot\Citrix\StorageCenter\Tools.

4. Right-click SfConfig.zip, choose **Properties**, and click **Unblock** to remove the security block.

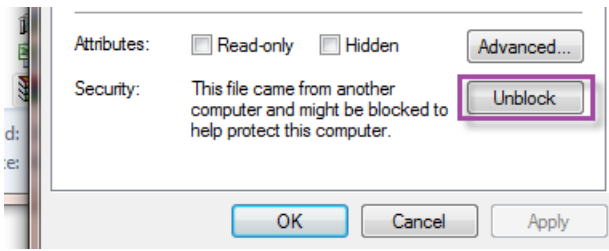

5. Extract the zip file to C:\inetpub\wwwroot\Citrix\StorageCenter\Tools.

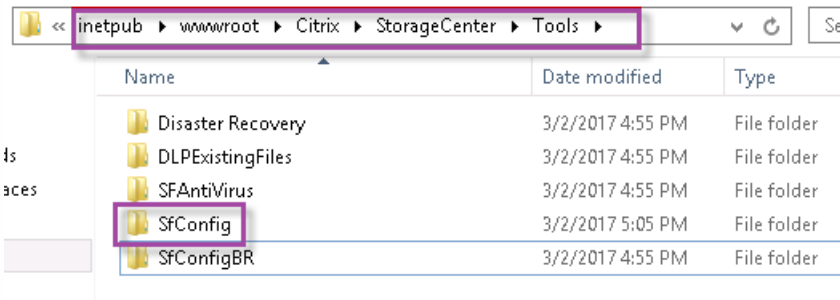

6. Run the PsExec tool: Open the Command Prompt as the Administrator User and then type the following:

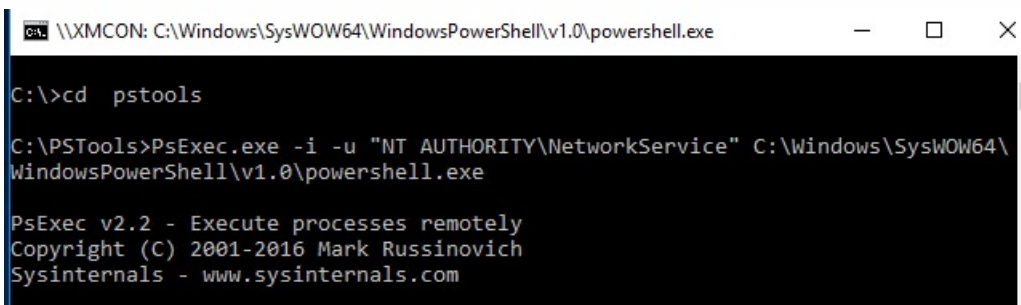
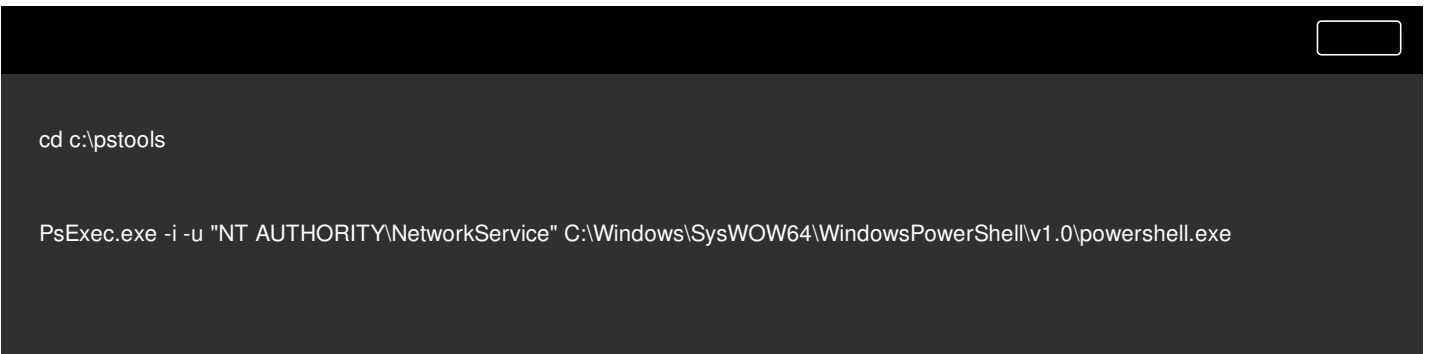

7. When prompted, click Agree to run the Sysinternals tool.

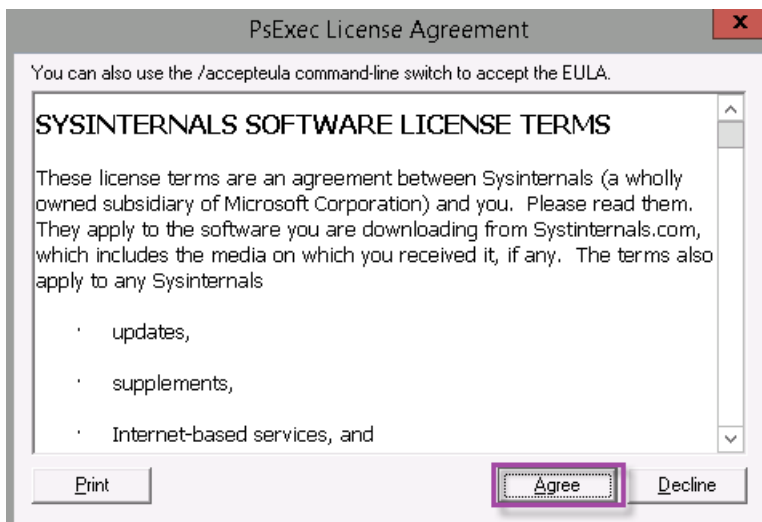

A PowerShell window opens.

8. In the PowerShell window, type the following:

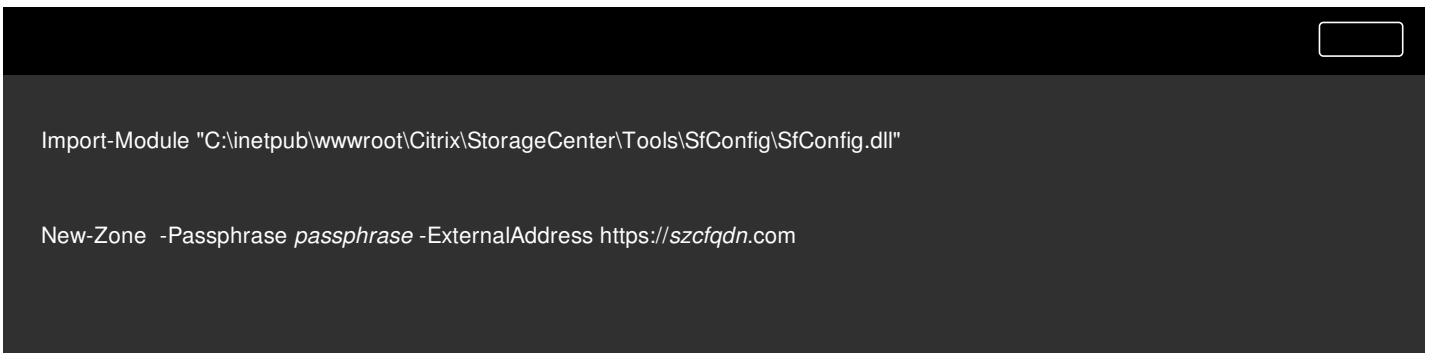

Where:

Passphrase: Is the passphrase you want to assign to the site. Make a note of it. You cannot recover the passphrase from the controller. If you lose the passphrase, you cannot reinstall StorageZones, join more StorageZones Controllers to the StorageZone, or recover the StorageZone if the server fails.

ExternalAddress: Is the external fully qualified domain name of the StorageZones Controller server.

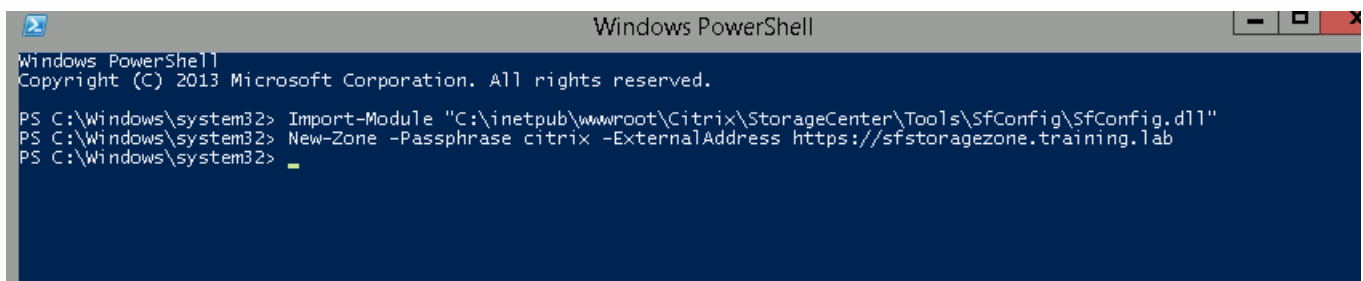

Your primary StorageZones Controller is now ready.

Before you log in to XenMobile to create StorageZone Connectors: Complete the following configuration, if applicable:

[Specify a proxy server for StorageZones](#)

[Configure the domain controller to trust the StorageZones Controller for delegation](#)

[Join a secondary StorageZones Controller to a StorageZone](#)

To create StorageZone Connectors, see [Define StorageZones Controller connections in XenMobile](#).

To configure a StorageZone for high availability, connect at least two StorageZones Controllers to it. To join a secondary StorageZones Controller to a zone, install StorageZones Controller on a second server. Then join that controller to the zone of the primary controller.

1. Open a PowerShell window on the StorageZones Controller server that you want to join to the primary server.
2. In the PowerShell window, type the following:

```
Join-Zone -Passphrase <passphrase> -PrimaryController <HostnameOrIP>
```

For example:

```
Join-Zone -Passphrase secret123 -PrimaryController 10.10.110.210
```

Before you add StorageZone Connectors, you configure connection information for each StorageZones Controller enabled for StorageZone Connectors. You can define StorageZones Controllers as described in this section, or when you add a connector.

On your first visit to the **Configure > ShareFile** page, the page summarizes the differences between using XenMobile with ShareFile Enterprise and with StorageZone Connectors.

XenMobile Analyze Manage **Configure** ⚙️ 🔍 administrator ▾

Device Policies Apps Actions **ShareFile** Enrollment Profiles Delivery Groups

Choose a method for integrating ShareFile with XenMobile or learn more about which mode to select.

	ShareFile Enterprise	StorageZone Connectors Only
Access network shares and SharePoint data from mobile devices	✓	✓
Edit Microsoft Office documents from mobile devices	✓	✓
Preview and annotate Adobe PDF files from mobile devices	✓	✓
Store data in Citrix-managed or customer-managed StorageZones or both	✓	
Securely share files with people inside and outside the enterprise	✓	
Sync files and data across multiple devices	✓	
Access files through the ShareFile website	✓	
Access Office 365 content and Personal Cloud connectors from mobile devices	✓	
Use auditing and reporting capabilities	✓	

[Configure ShareFile Enterprise](#) [Configure Connectors](#)

Click **Configure Connectors** to continue with the configuration steps in this article.

XenMobile Analyze Manage **Configure** ⚙️ 🔍 administrator ▾

Device Policies Apps Actions **ShareFile** Enrollment Profiles Delivery Groups

StorageZone Connectors ▾ [Show filter](#) 🔍

StorageZone Connectors provide access to documents and folders in SharePoint sites and network file shares.

[Add](#) | [Manage StorageZones](#)

<input type="checkbox"/>	Connector Name	Type	StorageZone	Location	Delivery Groups
					▾

1. In **Configure > ShareFile**, click **Manage StorageZones**.

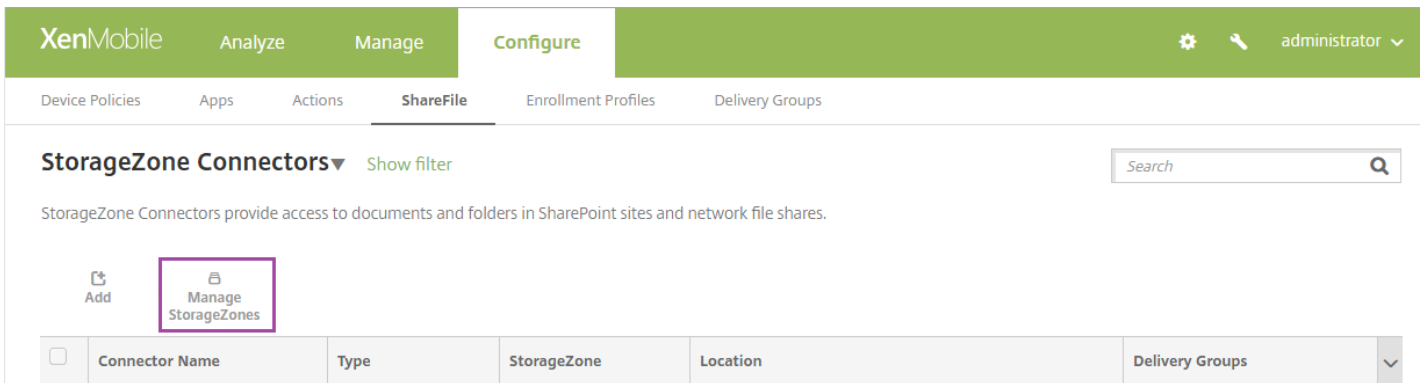

2. In Manage StorageZones, add the connection information.

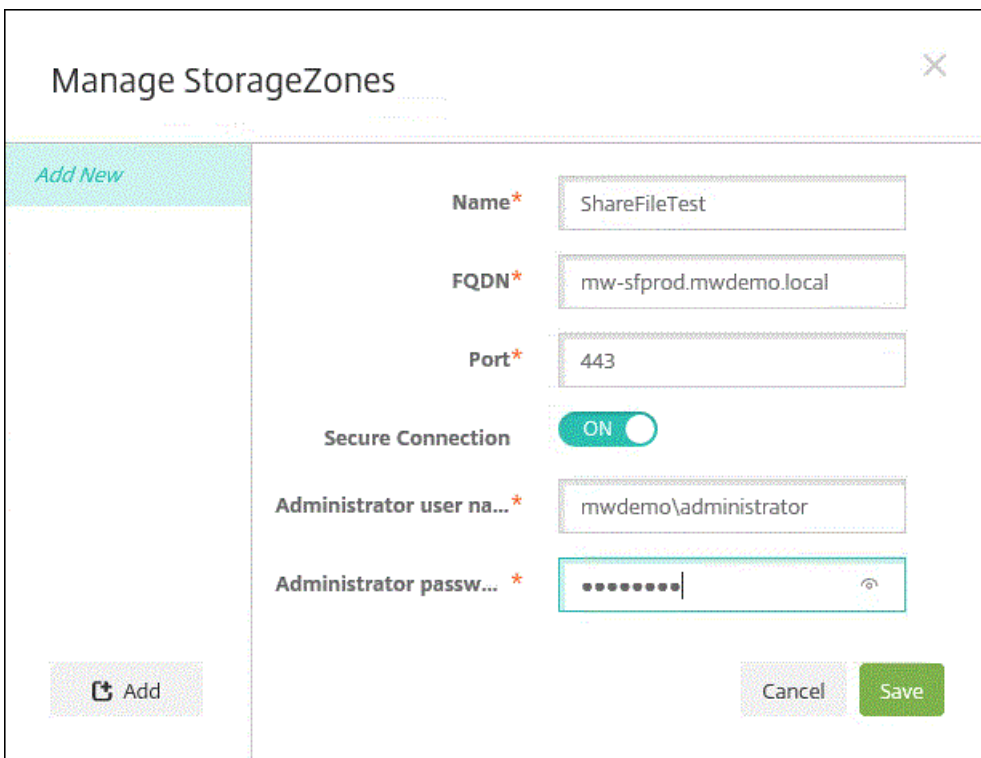

- **Name:** A descriptive name for the StorageZone, used to identify the StorageZone in XenMobile. Don't include a space or special characters in the name.
- **FQDN and Port:** The fully qualified domain name and port number for a StorageZones Controller that is reachable from the XenMobile Server.
- **Secure Connection:** If you use SSL for connections to StorageZones Controller, use the default setting, ON. If you don't use SSL for connections, change this setting to OFF.
- **Administrator user name and Administrator password:** An administrator service account user name (in the form domain\admin) and password. Alternatively, a user account with read and write permissions on the StorageZones Controllers.

3. Click Save.

4. To test the connection, verify that XenMobile Server can reach the fully qualified domain name of the StorageZones

Controller on port 443.

5. To define another StorageZones Controller connection, click the **Add** button in **Manage StorageZones**.

To edit or delete the information for a StorageZones Controller connection, select the connection name in **Manage StorageZones**. Then, click **Edit** or **Delete**.

1. Go to **Configure > ShareFile** and then click **Add**.

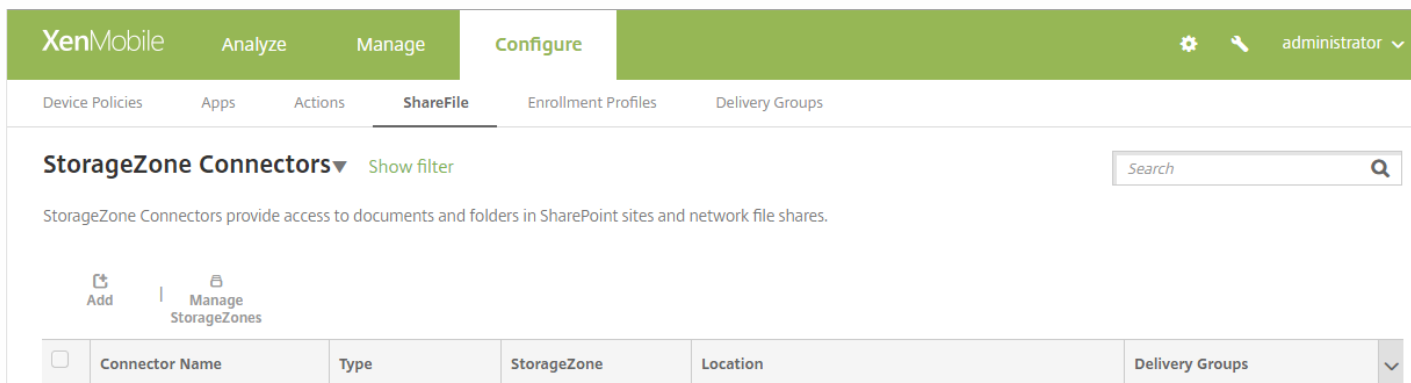

2. On the **Connector Info** page, configure these settings:

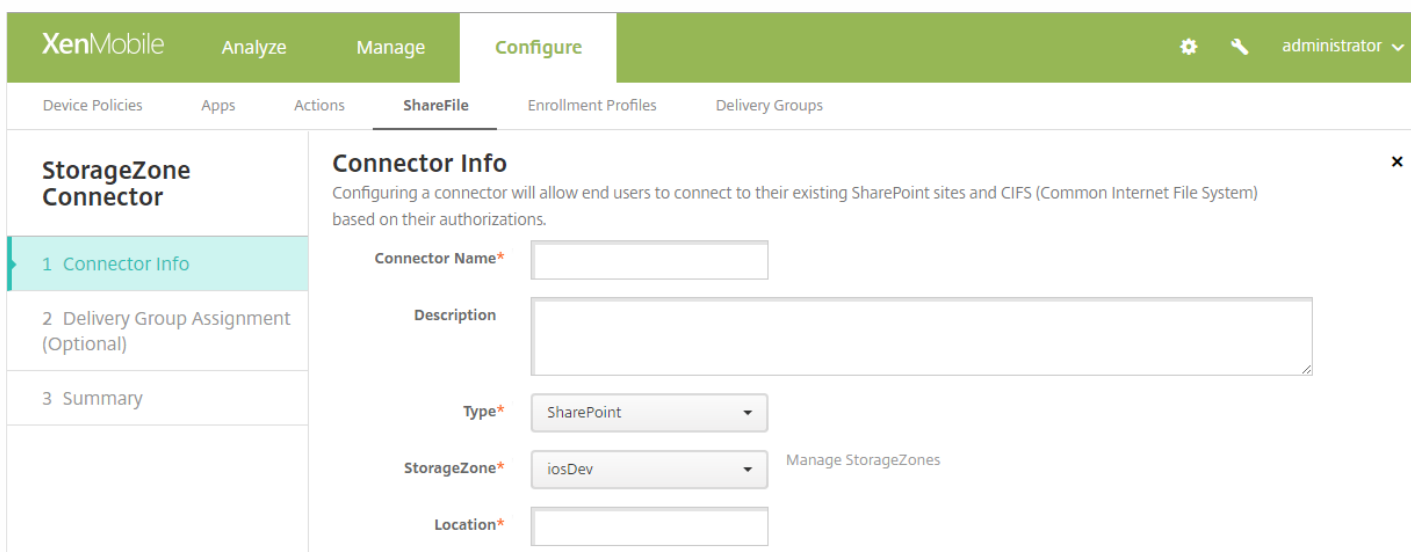

- **Connector Name:** A name that identifies the StorageZone Connector in XenMobile.
- **Description:** Optional notes about this Connector.
- **Type:** Choose either **SharePoint** or **Network**.
- **StorageZone:** Choose the StorageZone associated with the Connector. If the StorageZone isn't listed, click **Manage StorageZones** to define the StorageZones Controller.
- **Location:** For SharePoint, specify the URL of the SharePoint root-level site, site collection, or document library, in the form `https://sharepoint.company.com`. For a network share, specify the fully qualified domain name of the Uniform Naming Convention (UNC) path, in the form `\\server\share`.

3. On the **Delivery Group Assignment** page, optionally assign the Connector to delivery groups. Alternatively, you can associate connectors to delivery groups using **Configure > Delivery Groups**.

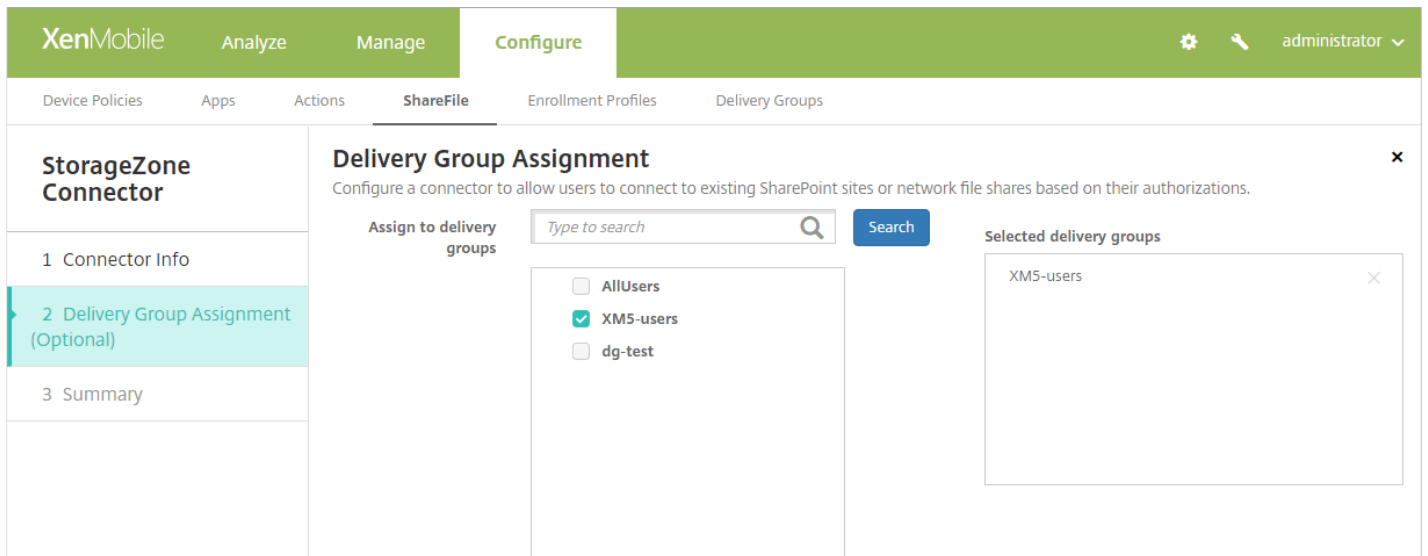

4. On the **Summary** page, you can review the options you configured. To adjust the configuration, click **Back**.

5. Click **Save** to save the Connector.

6. Test the connector:

a. When you wrap the ShareFile clients, do the following:

- Set the Network access policy to **Tunneled to the internal network**.

In this mode of operation, the XenMobile MDX framework intercepts all network traffic from the ShareFile client. The traffic redirects through NetScaler Gateway by using an app-specific micro VPN.



- Set the Preferred VPN mode policy to **Secure browse**.

In this mode of tunneling, the MDX framework terminates SSL/HTTP traffic from an MDX app. MDX then initiates new connections to internal connections on behalf of the user. This policy setting enables the MDX framework to detect and respond to authentication challenges issued by web servers.

b. Add the ShareFile clients to XenMobile. For details, see [To add ShareFile clients to XenMobile](#).

c. From a supported device, verify single sign-on to ShareFile and connectors.

In the following samples, SharefileDev is the name of a connector.

-  Dashboard
-  SharefileDev

-  Queue
-  Settings



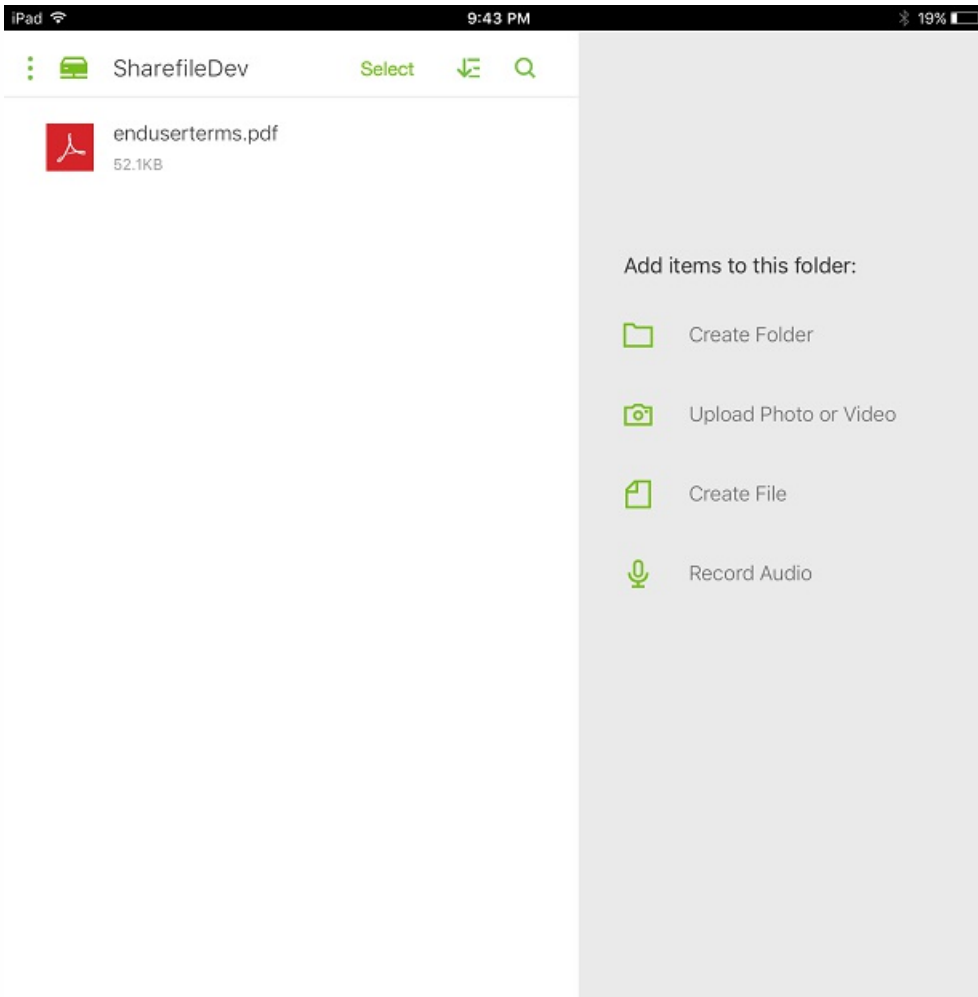

You can filter the list of StorageZone Connectors by Connector type, assigned delivery groups, and StorageZone.

1. Go to **Configure > ShareFile** and then click **Show filter**.

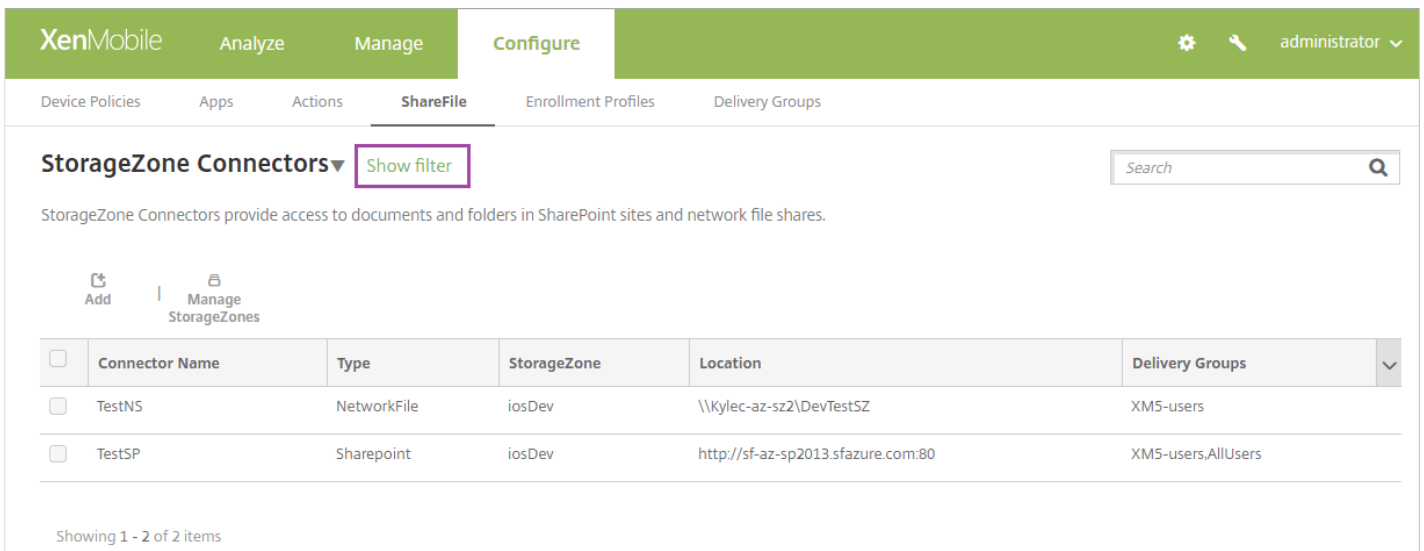

2. Expand the filter headings to make selections. To save a filter, click **Save This View**, type the filter name, and click **Save**.

StorageZone Connectors provide access to documents and folders in SharePoint sites and network file shares.

<input type="checkbox"/>	Connector Name	Type	StorageZone	Location	Delivery Groups
<input type="checkbox"/>	TestNS	NetworkFile	sz2	\\sz2\Storagezone	XM5-users
<input type="checkbox"/>	testxm	NetworkFile	sz1	\\sz1\Storagezone	XM5-users

Showing 1 - 2 of 2 items

SAVE THIS VIEW

3. To rename or delete a filter, click the arrow icon beside the filter name.

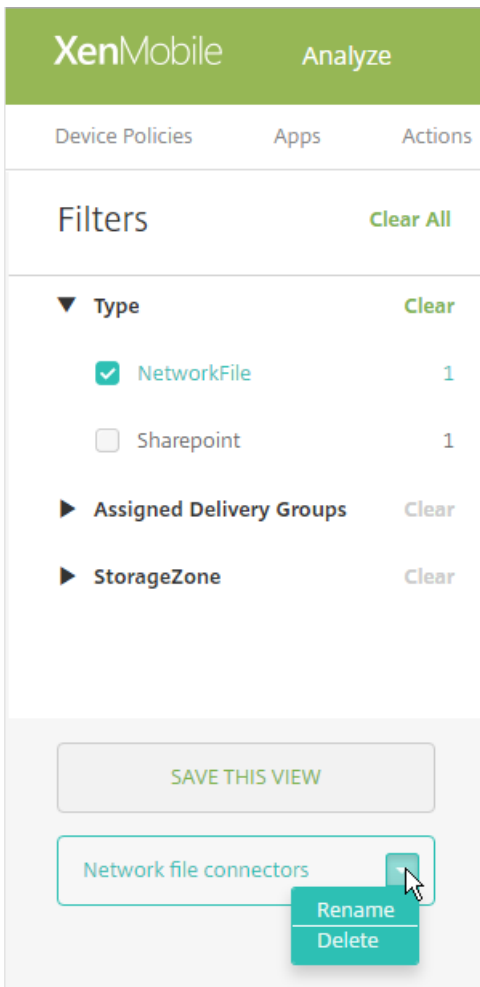

After integrating StorageZone Connectors with XenMobile, you can later switch to the full ShareFile Enterprise feature set. Use of the ShareFile Enterprise feature set requires XenMobile Enterprise Edition. XenMobile retains your existing StorageZone Connector integration settings.

Go to **Configure > ShareFile**, click the **StorageZone Connectors** drop-down menu, and then click **Configure ShareFile Enterprise**.

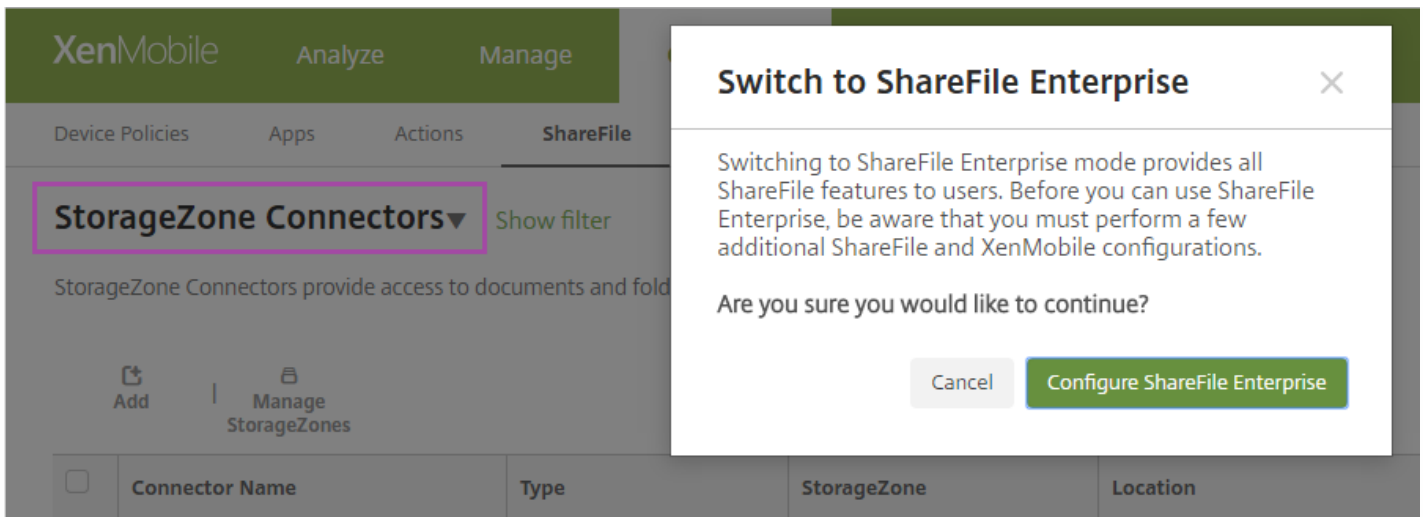

For information about configuring ShareFile Enterprise, see [SAML for single sign-on with ShareFile](#).

SmartAccess for HDX apps

Jun 19, 2017

This feature allows you to control access to HDX apps based on device properties, user properties of a device, or applications installed on a device. You use this feature by setting automated actions to mark the device as out of compliance to deny that device access. HDX apps used with this feature are configured in XenApp and XenDesktop by using a SmartAccess policy that denies access to out-of-compliance devices. XenMobile communicates the status of the device to StoreFront using a signed, encrypted tag. StoreFront then allows or denies access based on the access control policy of the app.

To use this feature, your deployment requires:

- XenApp and XenDesktop 7.6
- StoreFront 3.7 or 3.8
- XenMobile Server configured aggregate HDX apps from a StoreFront server
- XenMobile Server configured with a SAML certificate to be used for signing and encrypting tags. The same certificate without private key is uploaded on StoreFront server.

To start using this feature:

- Configure the XenMobile Server certificate to the StoreFront store
- Configure at least one XenApp and XenDesktop delivery group with the required SmartAccess policy
- Set the automated action in XenMobile

Export and configure the XenMobile Server certificate and upload it to the StoreFront store

SmartAccess uses signed and encrypted tags to communicate between the XenMobile and StoreFront servers. To enable that communication, you add the XenMobile Server certificate to the StoreFront store.

For more information about integrating StoreFront and XenMobile when XenMobile is enabled with domain and certificate-based authentication, see the [Support Knowledge Center](#).

1. In the XenMobile console, click the gear icon in the upper-right corner. The **Settings** page appears. Click **Certificates**.
2. Locate the SAML certificate for XenMobile Server.

Certificates

You must restart XenMobile on all nodes to commit and activate your changes to the SSL and Android for Work SAML certificates. To restart XenMobile, use the hypervisor console or command-line window.

<input type="checkbox"/>	Name	Description	Status	Valid from	Valid to	Type	Private key
<input checked="" type="checkbox"/>	XMS.example.com	Self Signed/Generated	Up to date	2016-05-23	2026-05-21	SAML	✓
<input type="checkbox"/>	*.mpg.citrix.com		Up to date	2016-04-20	2017-05-27	SSL Listener	✓
<input type="checkbox"/>	cacerts.pem	Self Signed/Generated	Up to date	2016-05-23	2036-05-21	Devices CA	
<input type="checkbox"/>	Verizon Public SureServer CA G14-SHA2		Up to date	2014-04-09	2021-04-09	Root or intermediate	
<input type="checkbox"/>	Baltimore CyberTrust Root		Up to date	2000-05-12	2025-05-12	Root or intermediate	

3. Ensure that **Export private key** is set to **Off**. Click **Export** to export the certificate to your download directory.

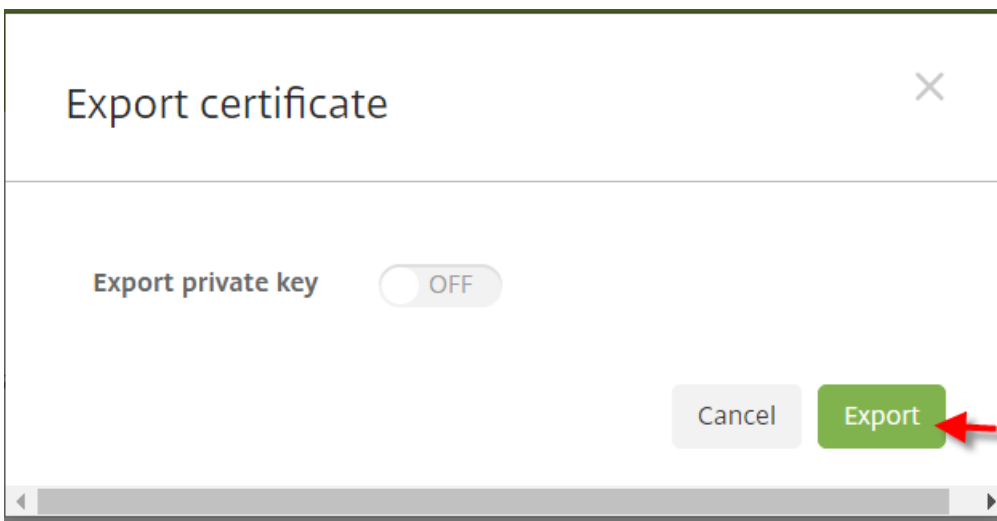

4. Locate the certificate in your download directory. The certificate is in PEM format.

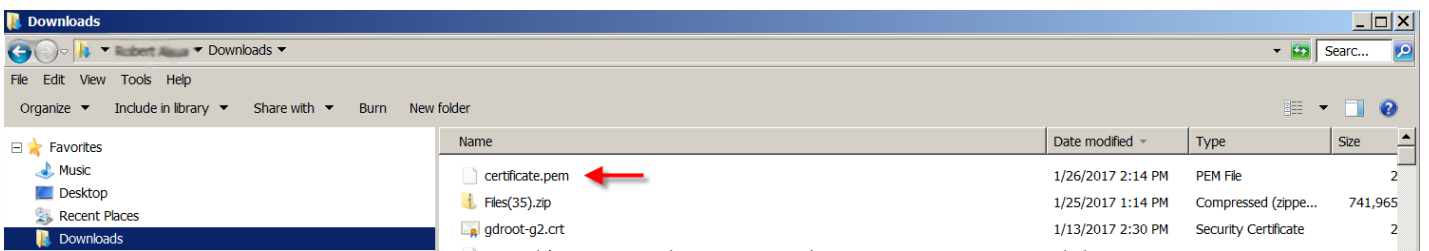

1. Open the Microsoft Management Console (MMC) and right-click **Certificates > All Tasks > Import**.

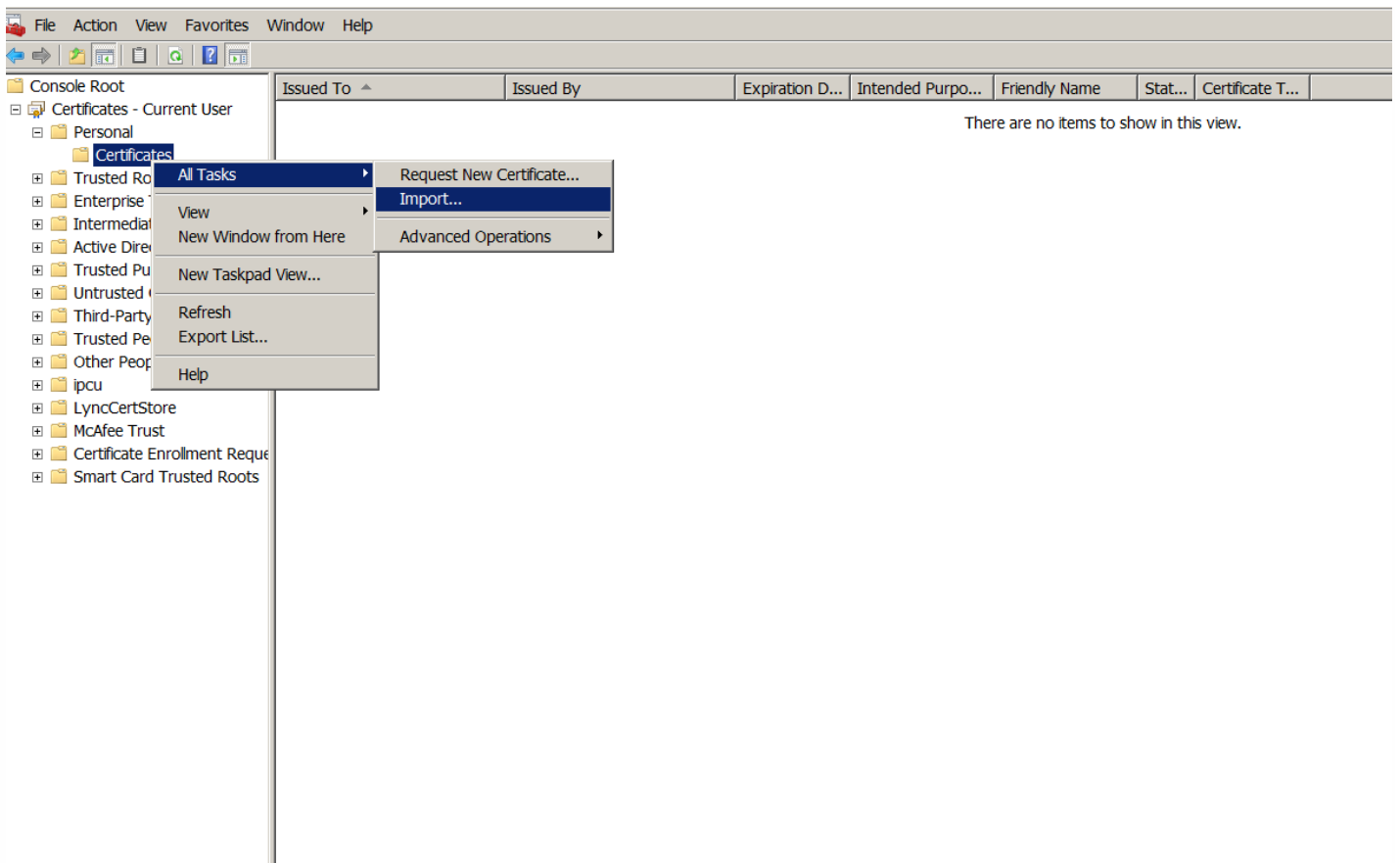

2. When the certificate import wizard appears, click **Next**.



3. Browse to the certificate in the download directory.

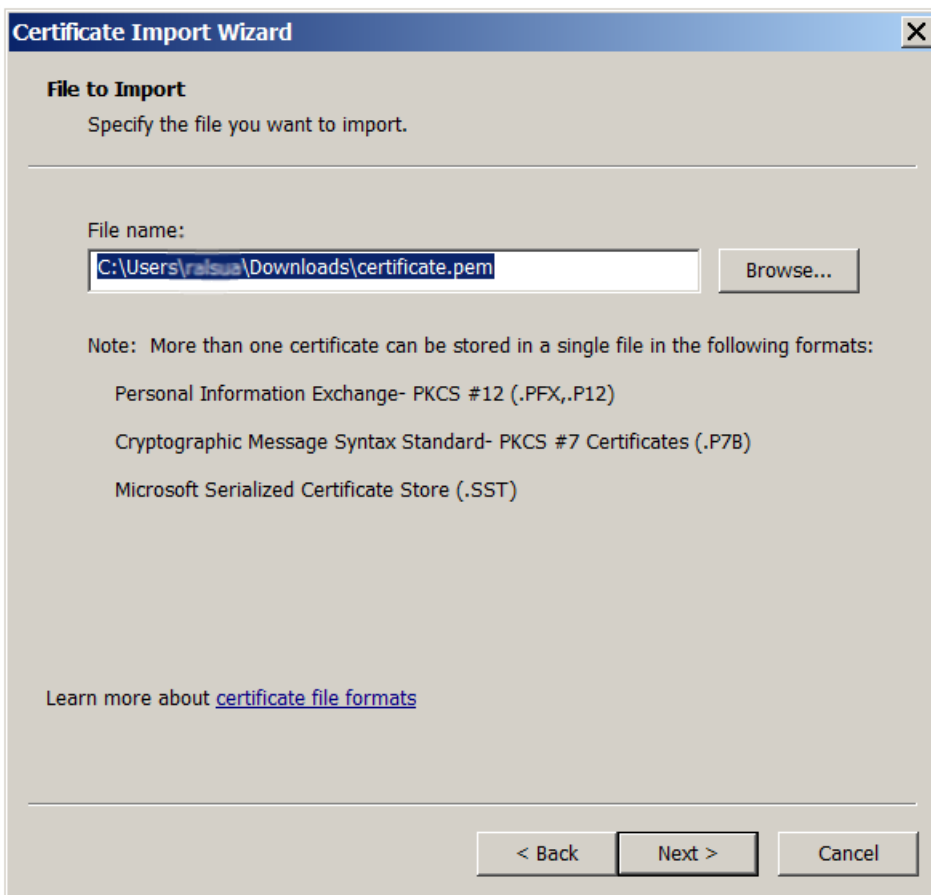

4. Select Place all certificates in the following store and select Personal as the certificate store. Click Next.

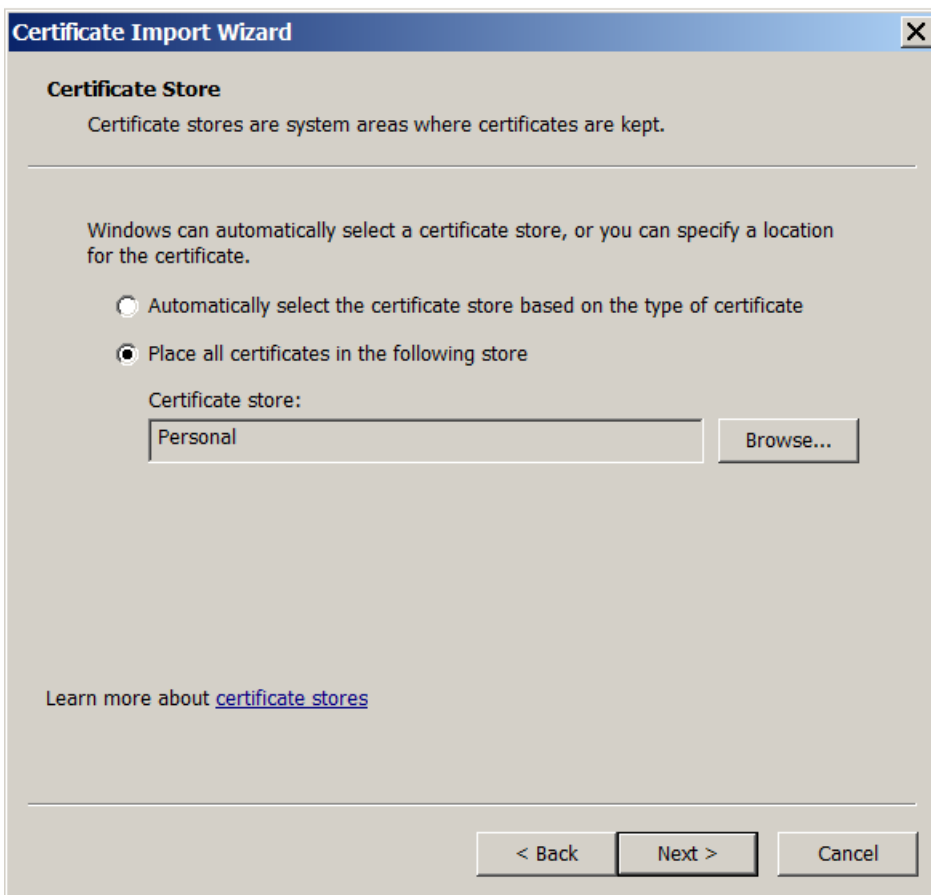

5. Review your selections and click **Finish**. Click **OK** to dismiss the confirmation window.

6. In the MMC, right-click the certificate and then choose **All Tasks > Export**.

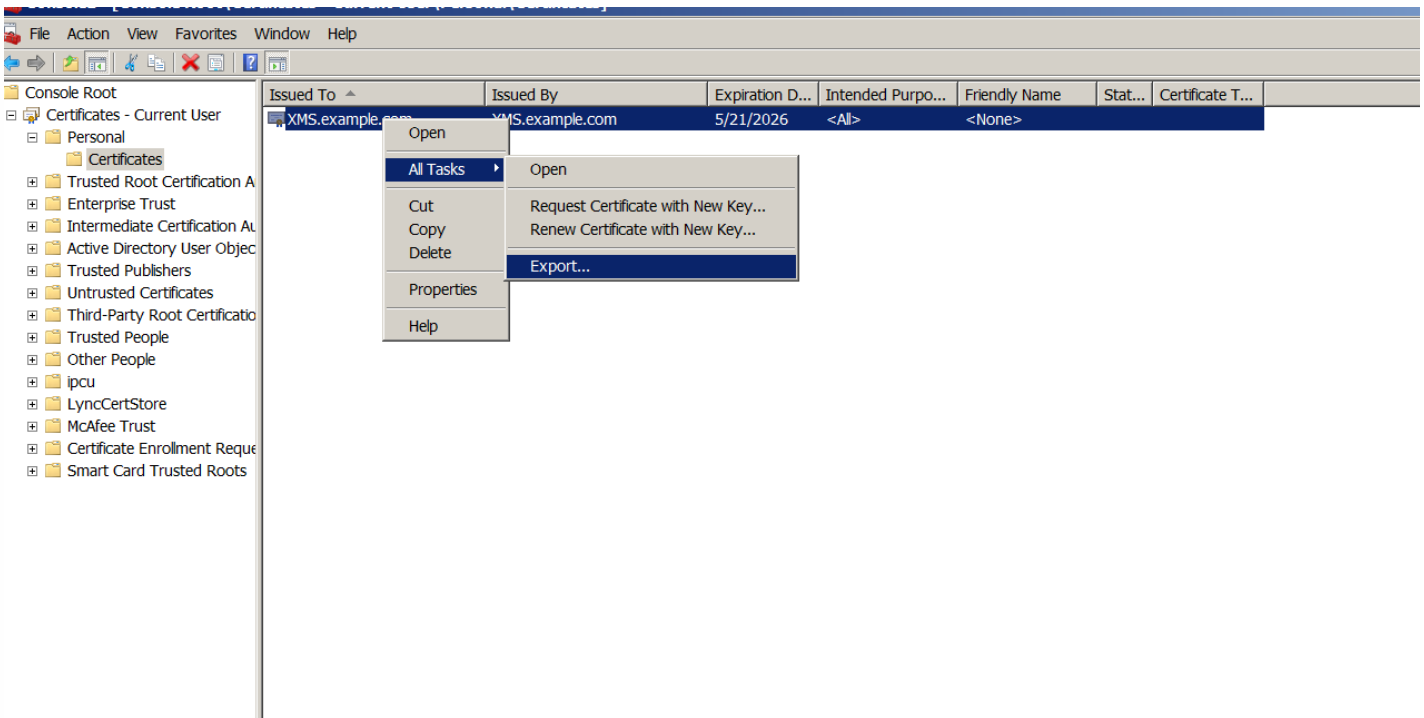

7. When the certificate export wizard appears, click **Next**.



8. Choose the format **DER encoded binary X.509 (.CER)**. Click **Next**.

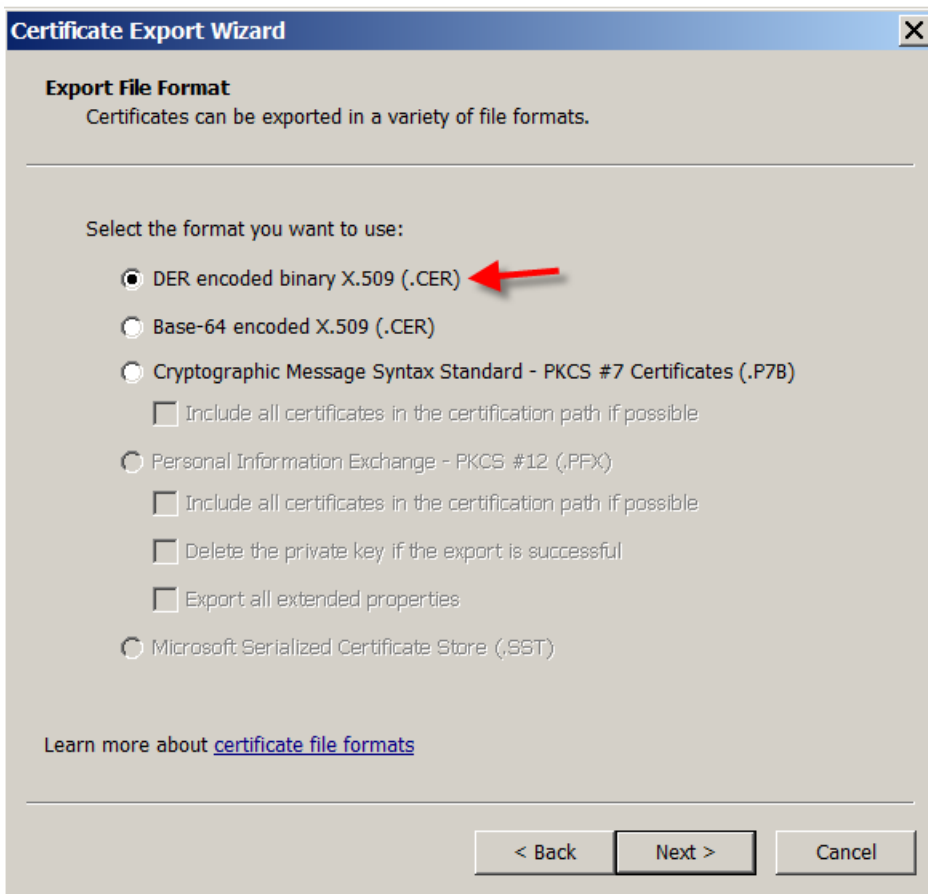

9. Browse to the certificate. Type a name for the certificate and then click **Next**.

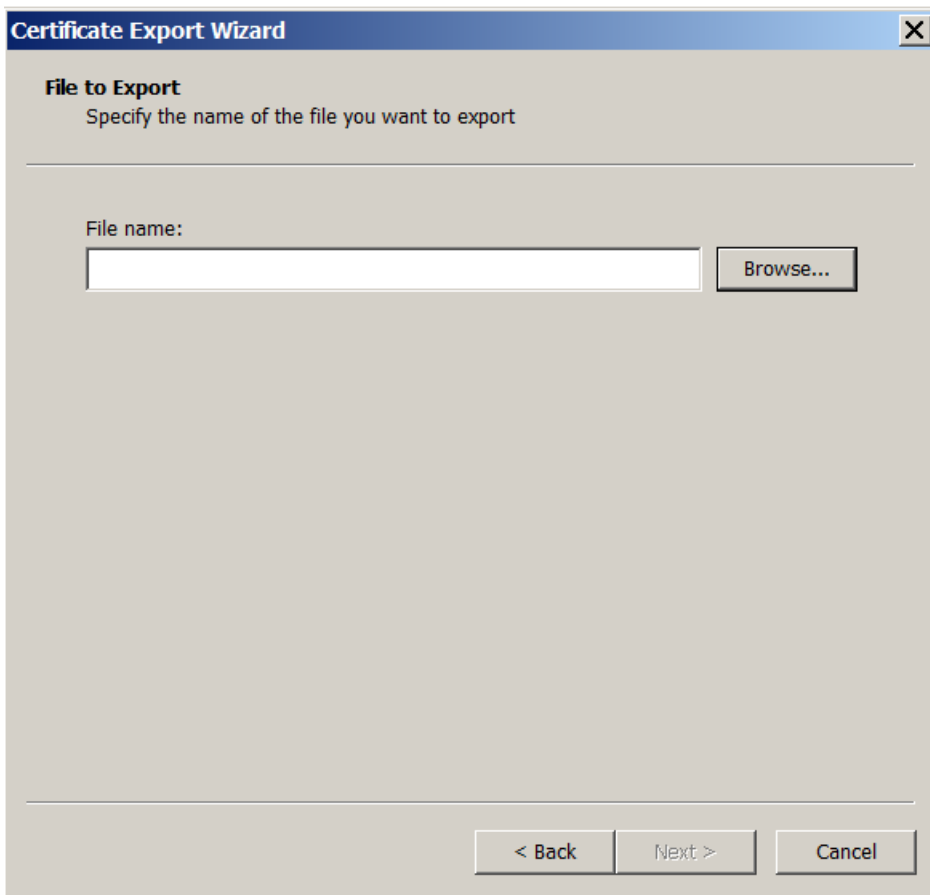

10. Save the certificate.

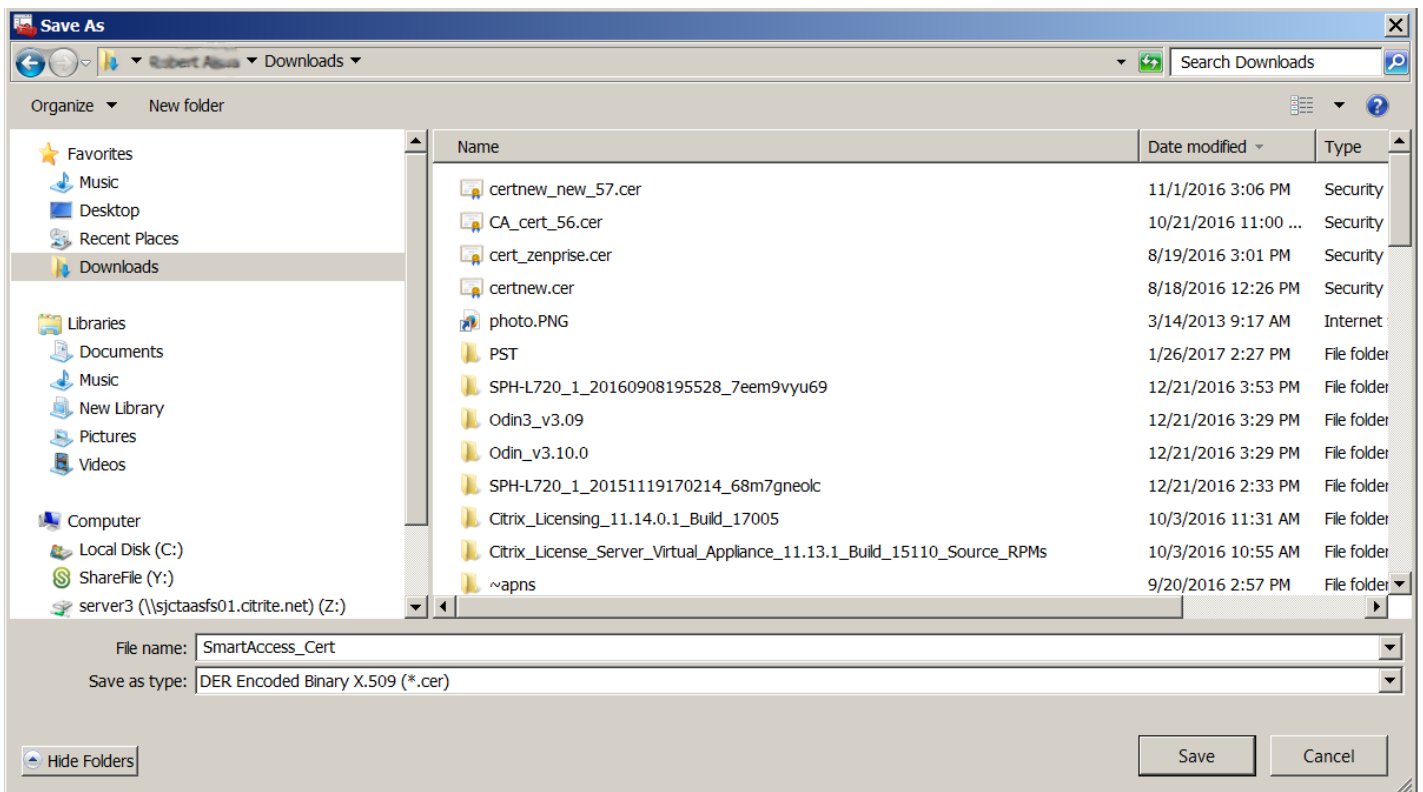

11. Browse to the certificate and click **Next**.

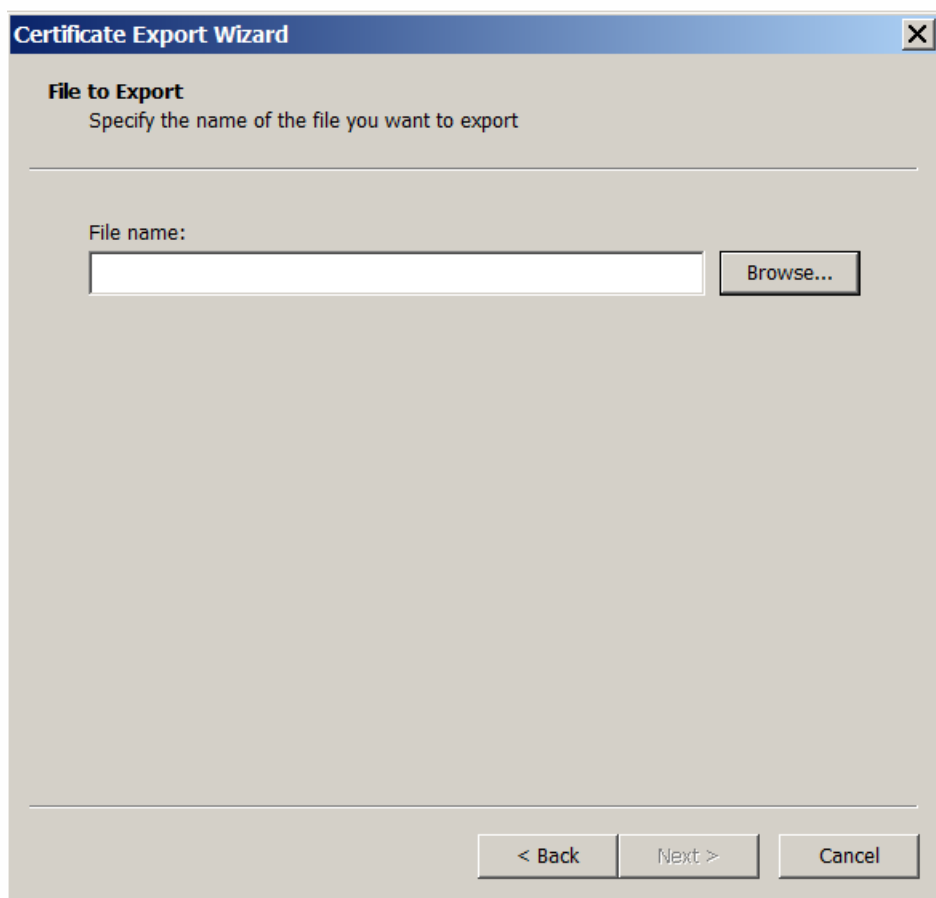

12. Review your selections and click **Finish**. Click **OK** to dismiss the confirmation window.

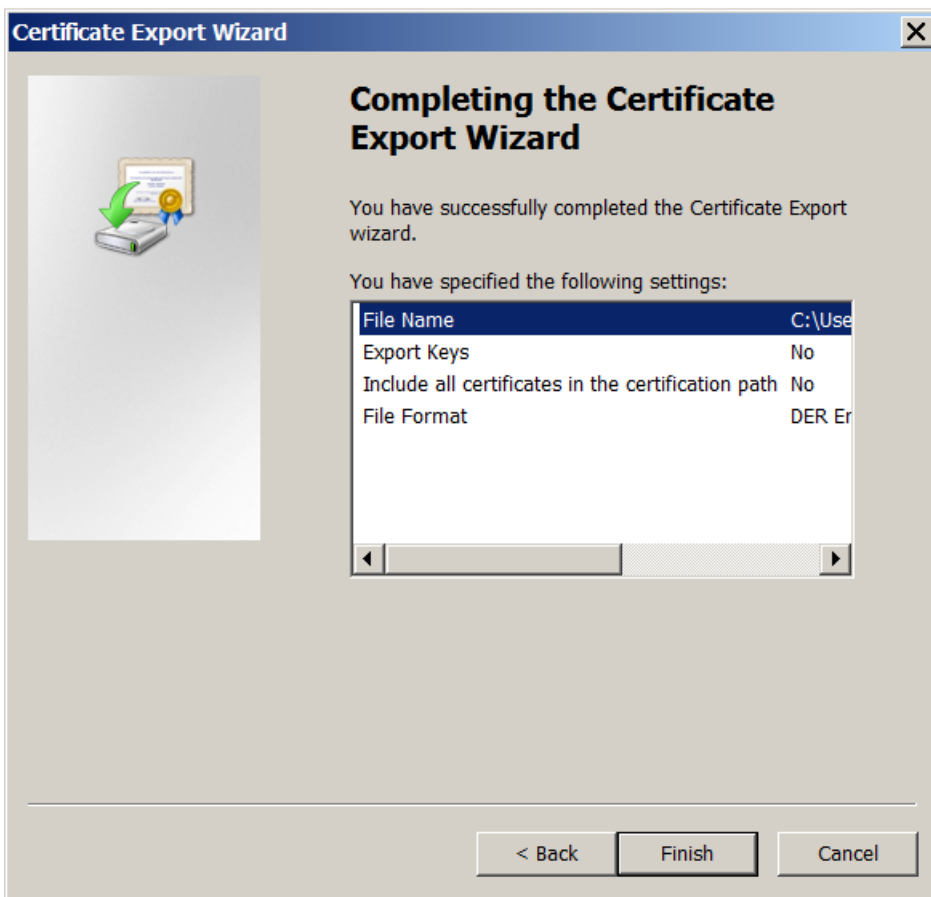

13. Locate the certificate in your download directory. Note that the certificate is in CER format.

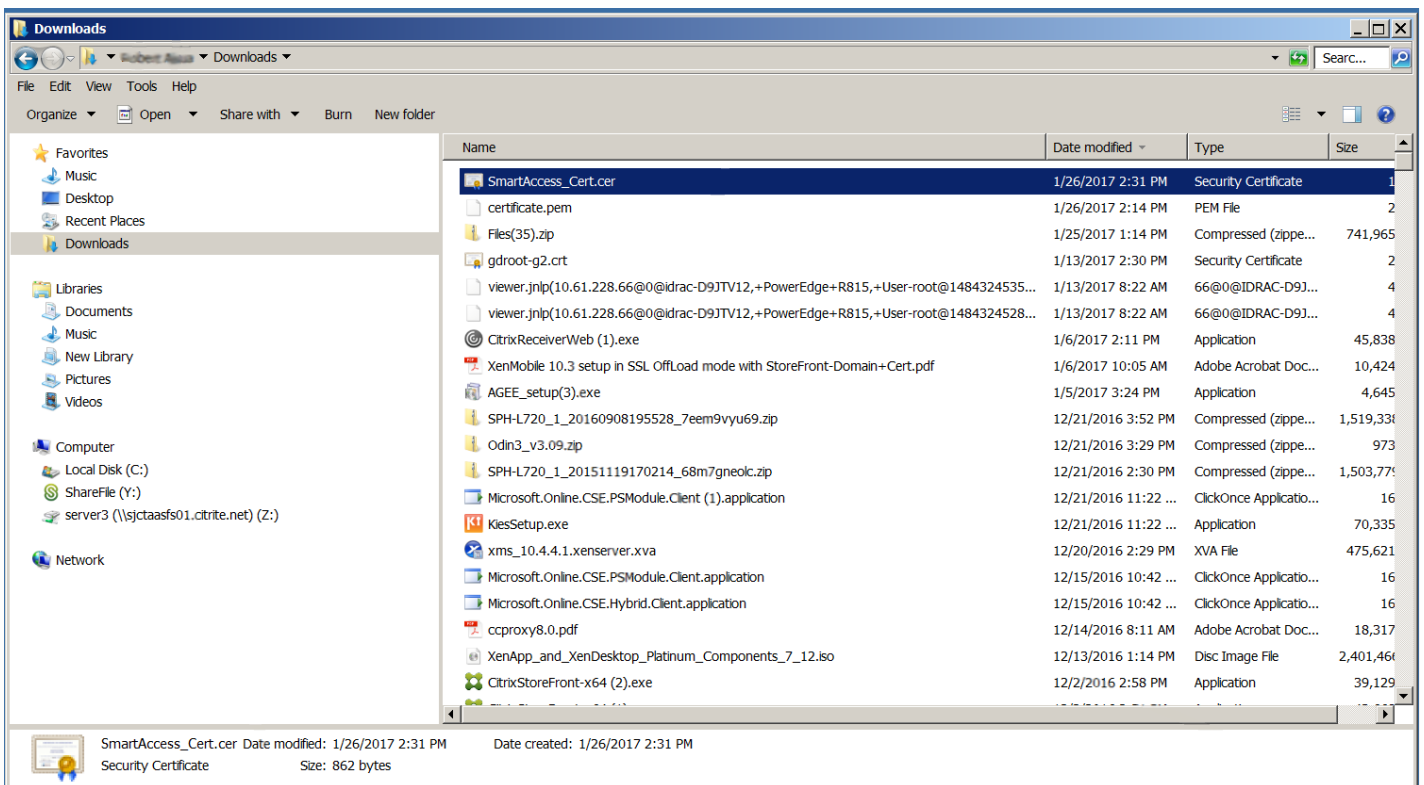

1. On the StoreFront server, create a folder called **SmartCert**.
2. Copy the certificate to the **SmartCert** folder.

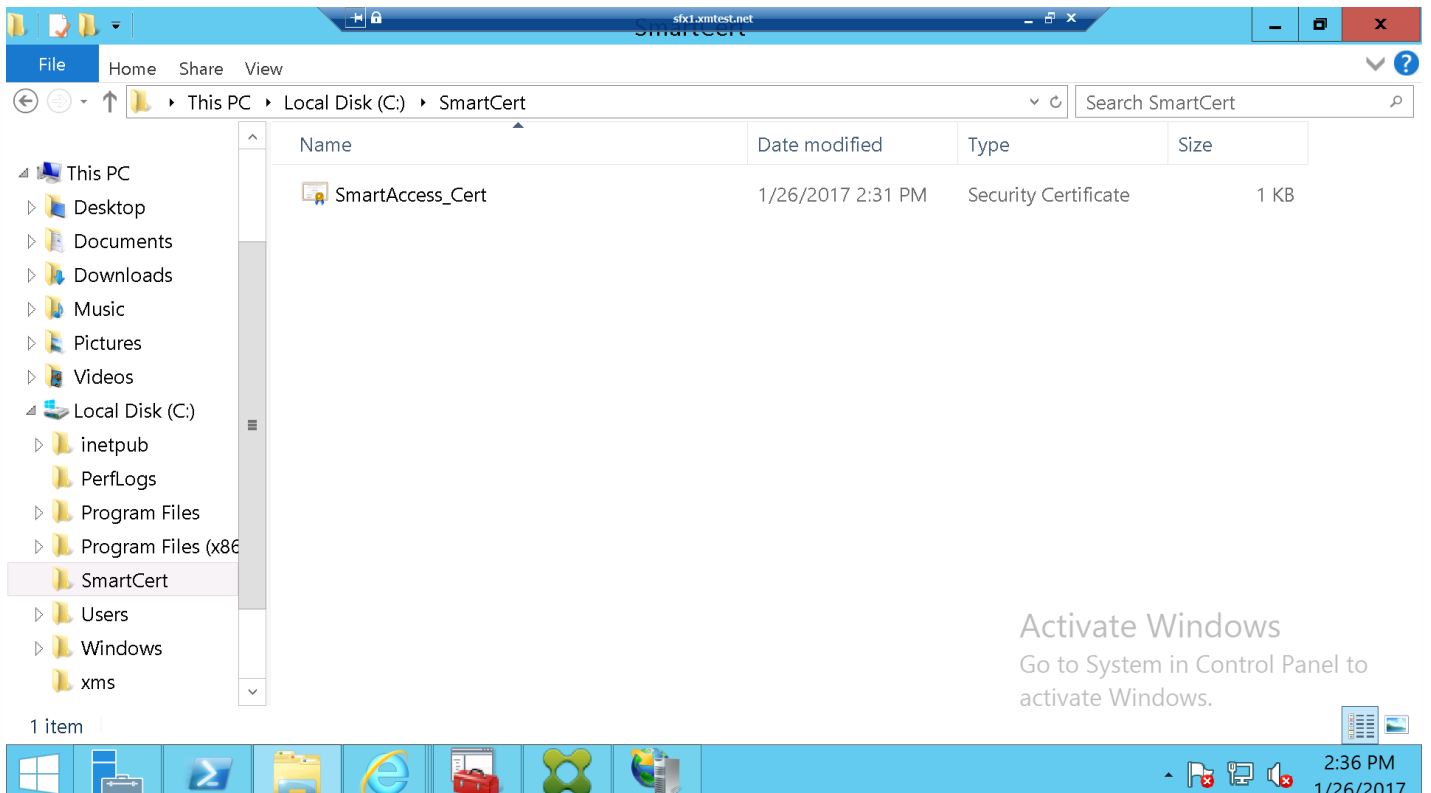

On the StoreFront server, run this PowerShell command to configure the converted XenMobile Server certificate on the store:

```
Grant-STFStorePnaSmartAccess -StoreService $store -CertificatePath "C:\xms\xms.cer" -ServerName "XMS server"
```

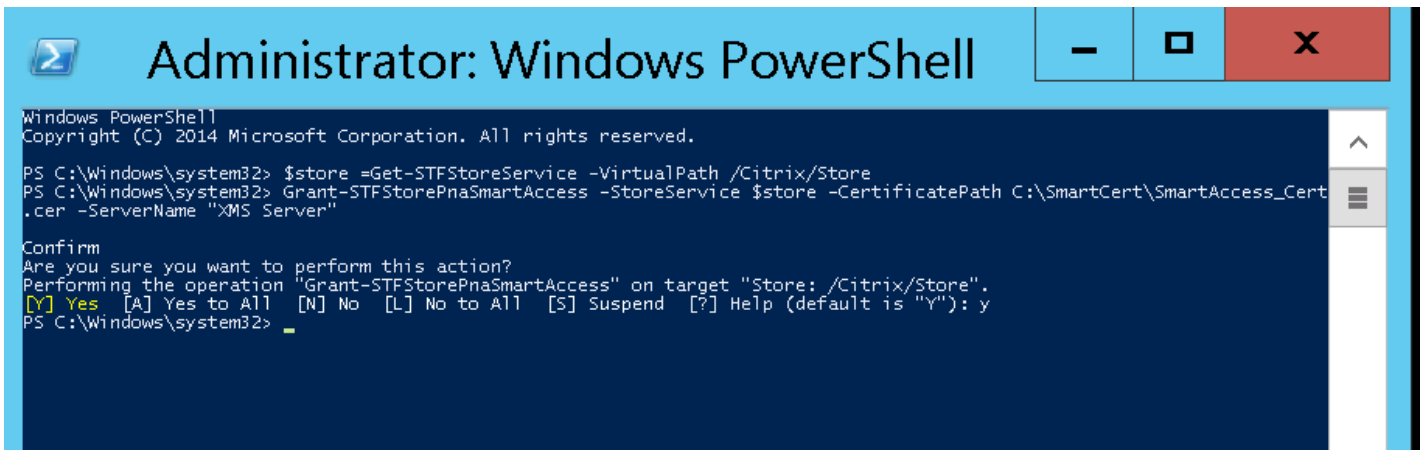

If there are any existing certificates on the StoreFront store, run this PowerShell command to revoke them:

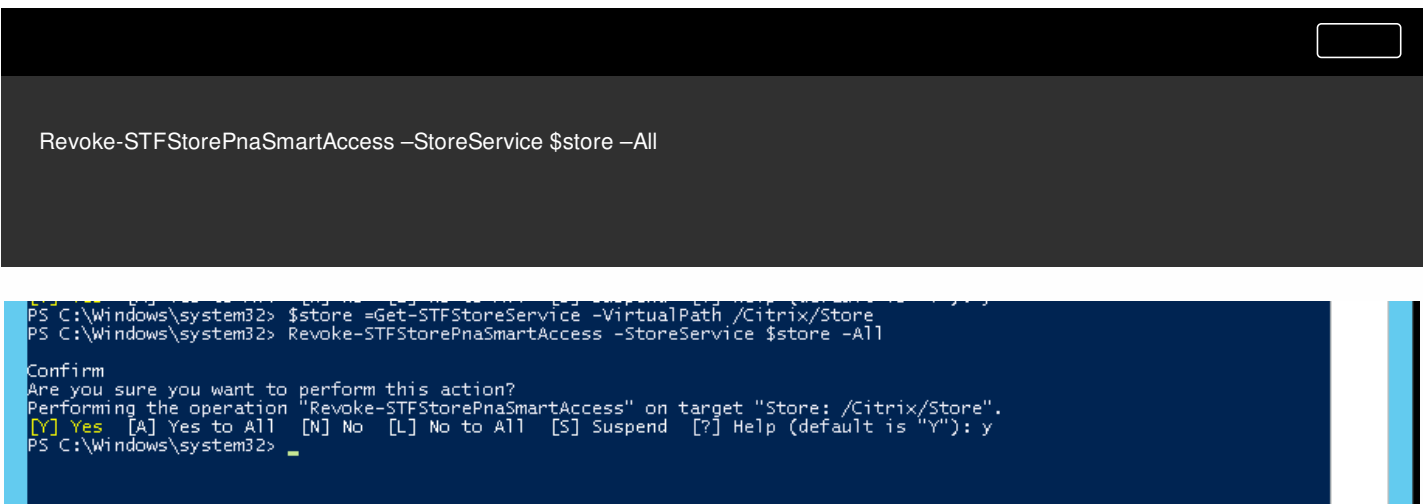

Alternatively, you can run any of these PowerShell commands on the StoreFront server to revoke existing certificates on the StoreFront store:

- Revoke by name:

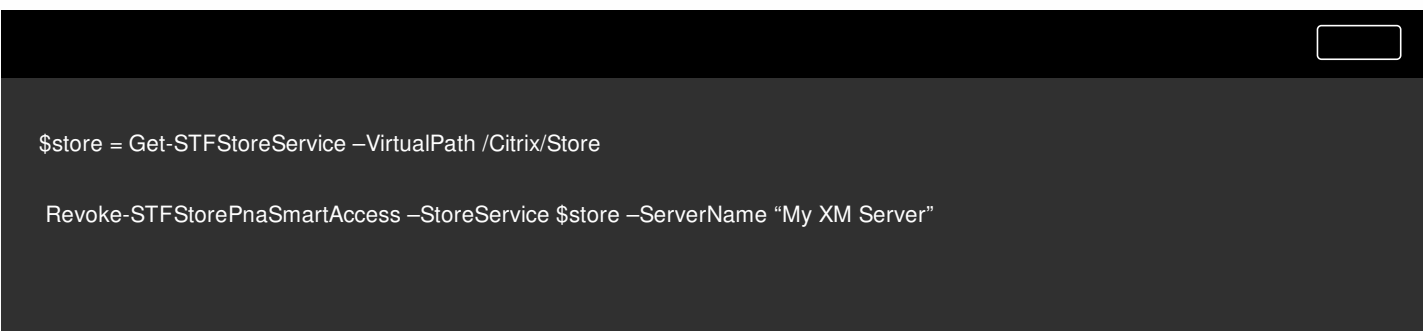

- Revoke by thumbprint:



```
$store = Get-STFStoreService -VirtualPath /Citrix/Store
```

```
Revoke-STFStorePnaSmartAccess -StoreService $store -CertificateThumbprint "1094821dec7834d5d42 bb456329efe4fca86c60b"
```

- Revoke by server object:

```
$store = Get-STFStoreService -VirtualPath /Citrix/Store
```

```
$access = Get-STFStorePnaSmartAccess -StoreService $store
```

```
Revoke-STFStorePnaSmartAccess -StoreService $store -SmartAccess $access.AccessConditionsTrusts[0]
```

Configure the SmartAccess policy for XenApp and XenDesktop

To add the required SmartAccess policy to the delivery group delivering the HDX app:

1. On the XenApp and XenDesktop server, open Citrix Studio.
2. Select **Delivery Groups** in the Studio navigation pane.
3. Select a group delivering the app or apps you want to control access to. Then select **Edit Delivery Group** in the Actions pane.
4. On the **Access Policy** page, select **Connections through NetScaler Gateway** and **Connection meeting any of the following**.
5. Click **Add**.
6. Add an access policy where **Farm** is **XM** and **Filter** is **XMCompliantDevice**.

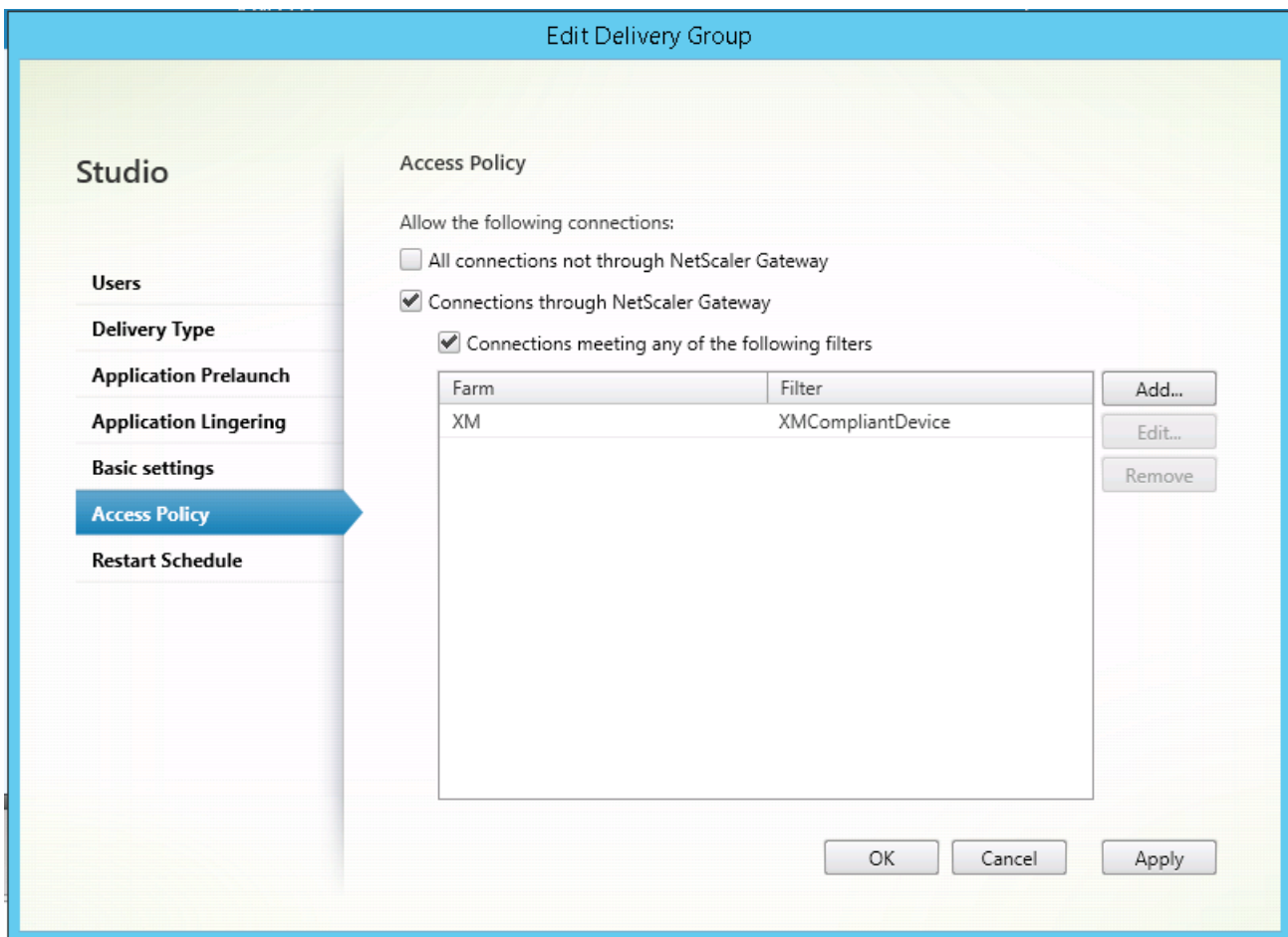

7. Click **Apply** to apply any changes you made and keep the window open, or click **OK** to apply changes and close the window.

Set automated actions in XenMobile

The SmartAccess policy that you set in the delivery group for an HDX app denies access to a device when the device is out of compliance. Use automated actions to mark the device as out of compliance.

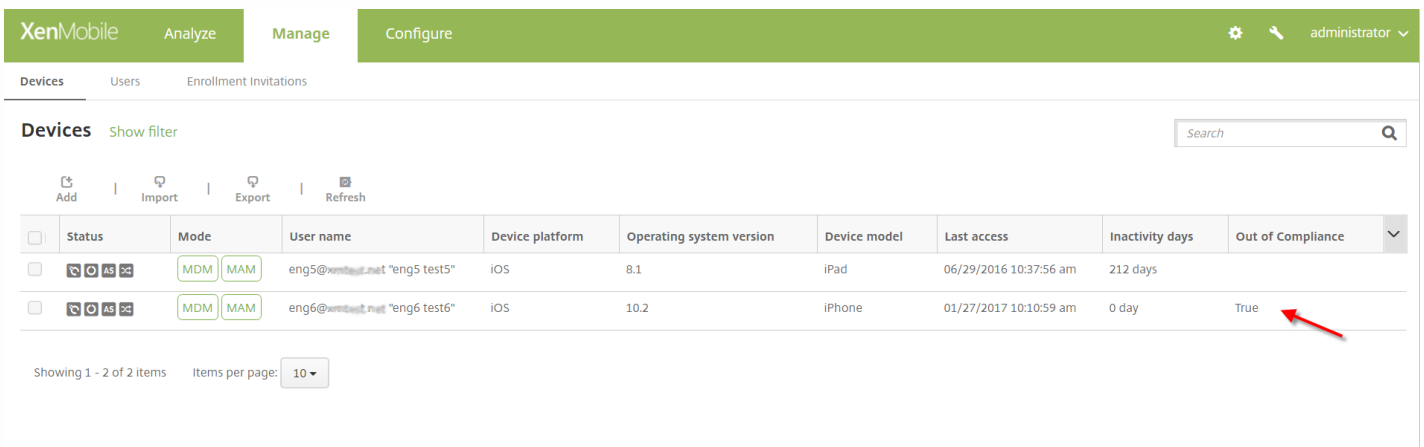

1. From the XenMobile console, click **Configure > Actions**. The **Actions** page appears.
2. Click **Add** to add an action. The **Action Information** page appears.
3. On the **Action Information** page, type a name and description for the action.

The screenshot shows the XenMobile console interface. The top navigation bar includes 'XenMobile', 'Analyze', 'Manage', and 'Configure'. Below this, there are tabs for 'Device Policies', 'Apps', 'Actions', 'ShareFile', 'Enrollment Profiles', and 'Delivery Groups'. The 'Actions' tab is selected. On the left, there is a sidebar with 'Actions' and a sub-menu with '1 Action Info', '2 Details', '3 Assignment (optional)', and '4 Summary'. The main content area is titled 'Action Information' and contains the text 'Actions automate common compliance requirements based on specific trigger events.' Below this text are two form fields: 'Name*' and 'Description'.

4. Click **Next**. The **Action details** page appears. In the following example, a trigger is created that immediately marks devices as out of compliance if they have the user property name **eng5** or **eng6**.

The screenshot shows the XenMobile console interface. The top navigation bar includes 'XenMobile', 'Analyze', 'Manage', and 'Configure'. Below this, there are tabs for 'Device Policies', 'Apps', 'Actions', 'ShareFile', 'Enrollment Profiles', and 'Delivery Groups'. The 'Actions' tab is selected. On the left, there is a sidebar with 'Actions' and a sub-menu with '1 Action Info', '2 Details', '3 Assignment (optional)', and '4 Summary'. The main content area is titled 'Action details' and contains the text 'Choose a trigger event and the associated action for that event.' Below this text are two main sections: 'Trigger*' and 'Action*'. The 'Trigger*' section has four fields: 'User property' (dropdown), 'Name' (dropdown), 'Is' (dropdown), and a text field containing 'eng6 test6'. The 'Action*' section has five fields: 'Mark the device as out of compliance' (dropdown), 'Is' (dropdown), 'True' (dropdown), a text field containing '0', and 'Hours' (dropdown). At the bottom right, there are 'Back' and 'Next >' buttons.

5. In the **Trigger** list, choose **Device property**, **User property**, or **Installed app name**. SmartAccess doesn't support event triggers.

6. In the **Action** list:

- Choose **Mark the device as out of compliance**.
- Choose **Is**.
- Choose **True**.
- To set the action to mark the device as out of compliance immediately when the trigger condition is met, set the time frame to **0**.

7. Choose the XenMobile delivery group or groups to apply this action to.

The screenshot shows the XenMobile console interface. At the top, there is a navigation bar with tabs for 'XenMobile', 'Analyze', 'Manage', and 'Configure'. Below this is a sub-navigation bar with options: 'Device Policies', 'Apps', 'Actions', 'ShareFile', 'Enrollment Profiles', and 'Delivery Groups'. The main content area is titled 'Assign to Delivery Group' and includes a search bar for delivery groups, a list of delivery groups (currently showing 'AllUsers' with a checked checkbox), and a 'Delivery groups to receive app assignment' list. A 'Deployment Schedule' section is partially visible at the bottom. Navigation buttons for 'Back' and 'Next >' are located at the bottom right of the screen.

8. Review the summary of the action.

The screenshot shows the XenMobile interface with the 'Configure' tab selected. The left sidebar contains a menu with 'Actions' highlighted. The main content area is titled 'Summary' and includes a sub-section 'General' with fields for 'Name' and 'Description'. Below this is an 'Action details' section with a text field containing the condition: 'If name is "eng6 test6", then mark the device as out of compliance immediately.' At the bottom, the 'Assignment' section shows 'Delivery groups' set to 'AllUsers'.

9. Click **Next** and then click **Save**.

When device is marked out of compliance, the HDX apps no longer appear in the Secure Hub store. The user is no longer subscribed to the apps. No notification is sent to the device and nothing in the Secure Hub store indicates that the HDX apps were previously available.

If you want users to be notified when a device is marked out of compliance, create a notification and then create an automated action to send that notification.

This example creates and sends this notification when a device is marked out of compliance: "Device serial number or telephone number no longer complies with the device policy and HDX applications will be blocked."

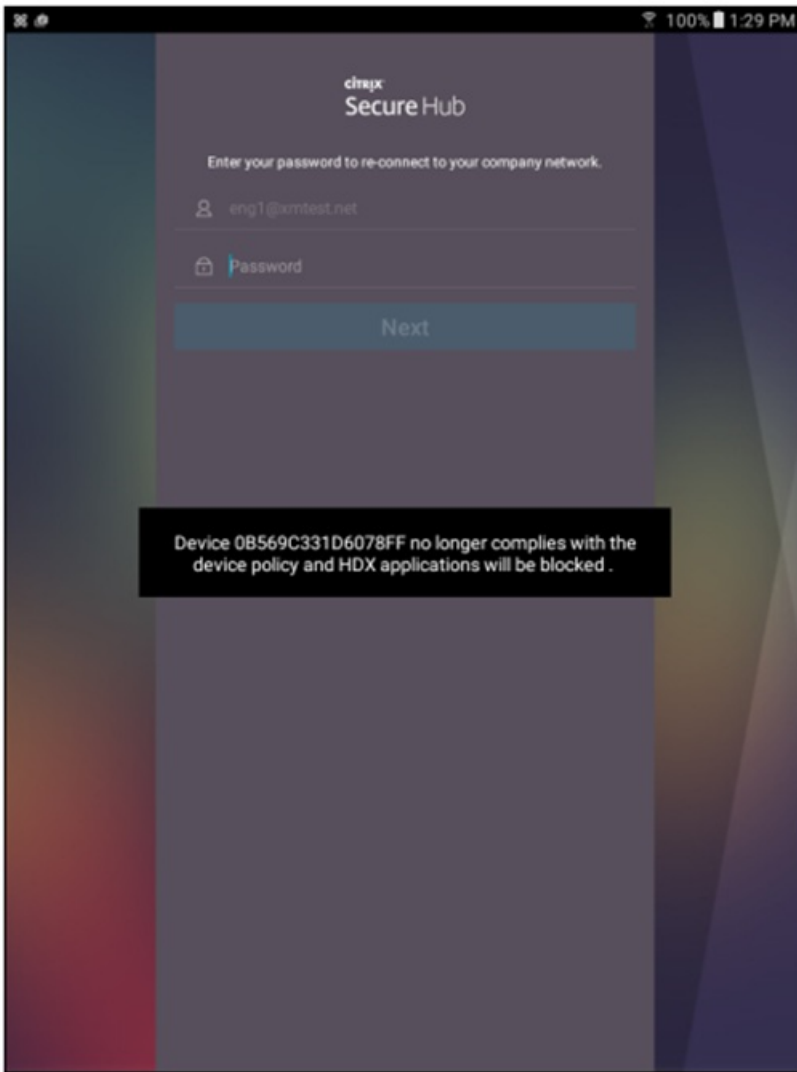

1. In the XenMobile console, click the gear icon in the upper-right corner of the console. The **Settings** page appears.
2. Click **Notification Templates**. The **Notification Templates** page appears.
3. Click **Add** to add on the **Notification Templates** page.
4. When prompted to set up the SMS server first, click **No, set up later**.

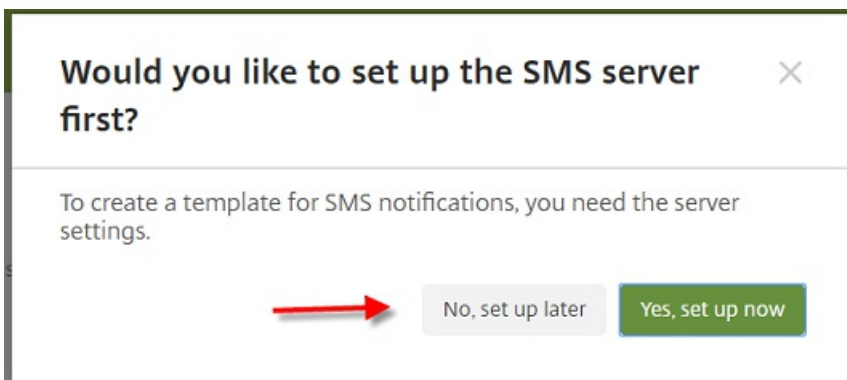

5. Configure these settings:

- **Name:** HDX Application Block
- **Description:** Agent notification when device is out of compliance
- **Type:** Ad-Hoc Notification
- **Secure Hub:** Activated
- **Message:** Device `${firstNotNull(device.TEL_NUMBER,device.serialNumber)}` no longer complies with the device policy and HDX applications will be blocked.

The screenshot shows a configuration form for an action. The fields are as follows:

- Name***: HDX Application Block
- Description**: (Empty text area)
- Type**: Ad-Hoc Notification (dropdown menu, with "Manual sending supported" text below it)
- SMTP**: Activate (green button)
- Sender**: (Empty text input)
- Recipient**: (Empty text input)
- Subject**: (Empty text input)
- Message**: (Empty text area)
- Secure Hub**: Activated (green button) / Deactivate (grey button)
- Message***: Device `${firstNotNull(device.TEL_NUMBER,device.serialNumber)}` no longer complies with the device policy and HDX applications will be blocked .

At the bottom right, there are "Cancel" and "Save" buttons.

6. Click Save.

1. From the XenMobile console, click **Configure > Actions**. The **Actions** page appears.
2. Click **Add** to add an action. The **Action Information** page appears.
3. On the **Action Information** page, enter a name and description for the action:
 - **Name:** HDX blocked notification
 - **Description:** HDX blocked notification because device is out of compliance

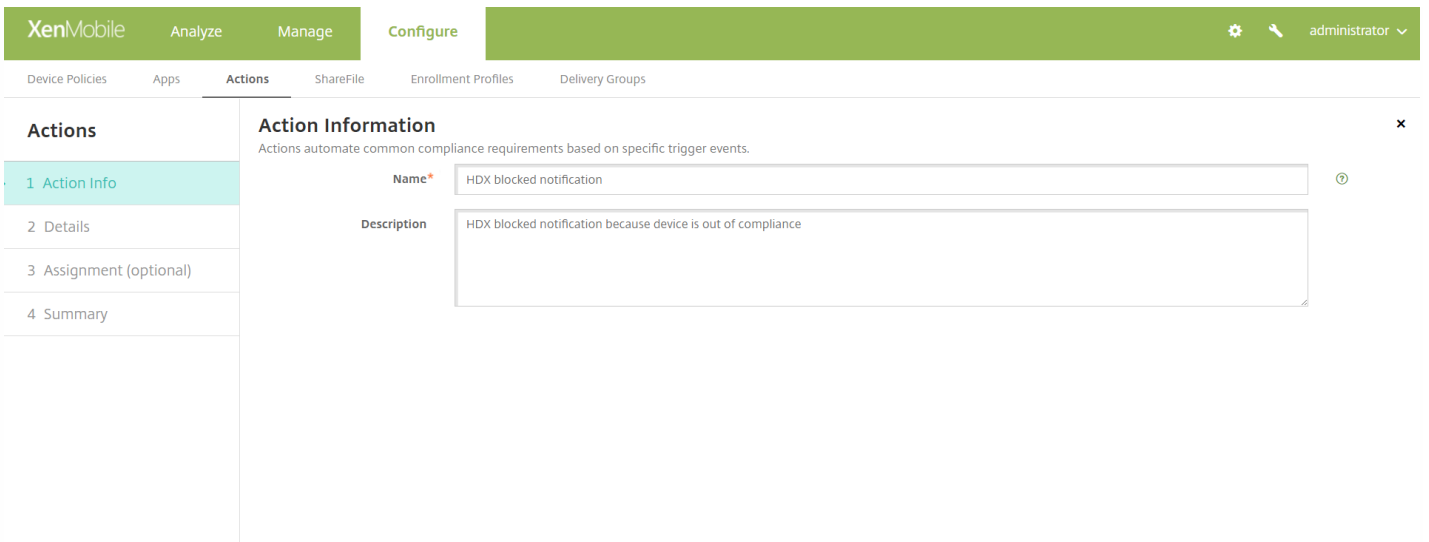

4. Click Next. The Action details page appears.

5. In the Trigger list:

- Choose Device property.
- Choose Out of compliance.
- Choose Is.
- Choose True.

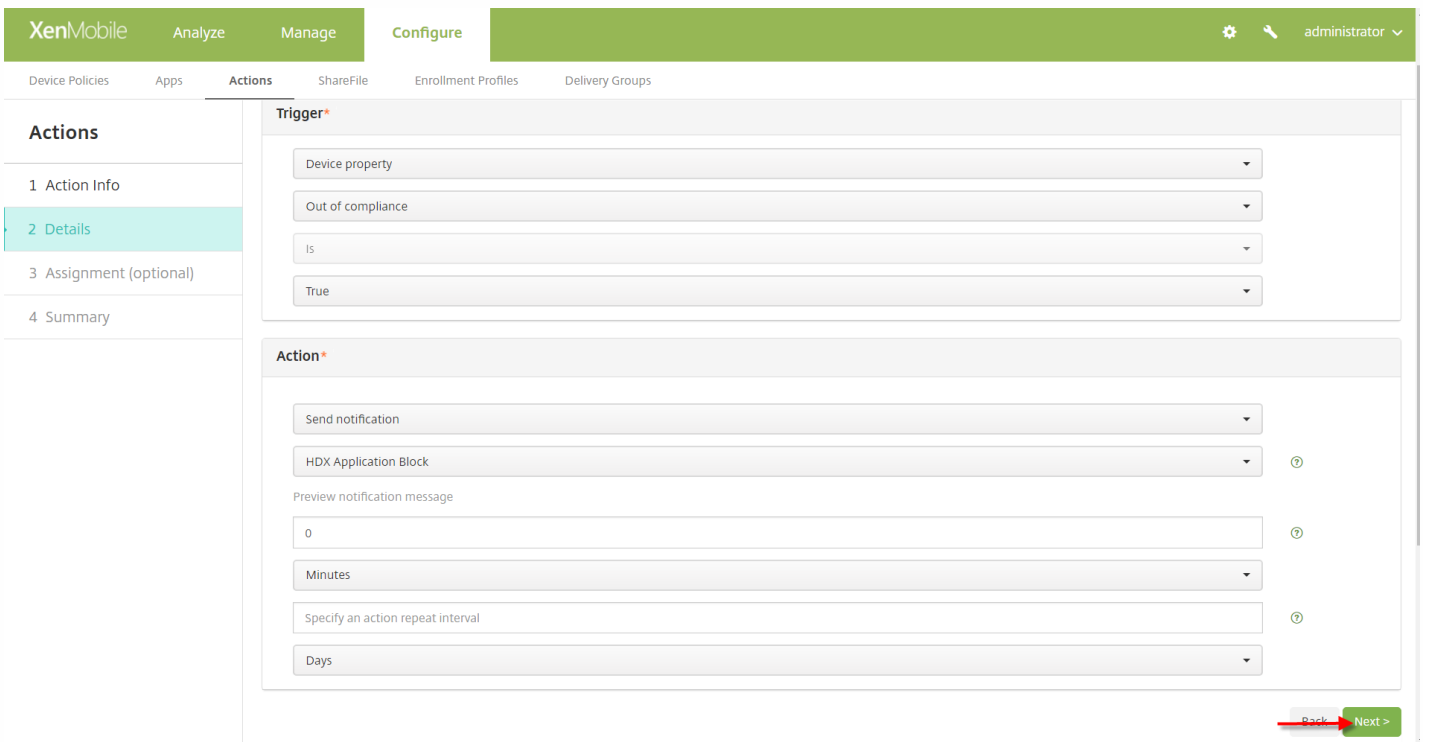

6. In the Action list, specify the actions that occur when the trigger is met:

- Choose Send notification

- Choose **HDX Application Block**, the notification you created.
- Choose **0**. Setting this value to 0 causes the notification to be sent as soon as the trigger condition is met.

7. Select the XenMobile delivery group or groups to apply this action to. In this example, choose **AllUsers**.

XenMobile Analyze Manage **Configure** administrator

Device Policies Apps **Actions** ShareFile Enrollment Profiles Delivery Groups

Actions

- 1 Action Info
- 2 Details
- 3 Assignment (optional)**
- 4 Summary

Assign to Delivery Group ✕

To deploy this action, assign it to one or more delivery groups.

Choose delivery groups

- AllUsers
- DG1
- DG2
- DG3
- DG4
- DG5
- DG6
- DG7
- DG8

Delivery groups to receive app assignment

AllUsers ✕

► **Deployment Schedule** ⌵

8. Review the summary of the action.

XenMobile Analyze Manage **Configure** administrator

Device Policies Apps **Actions** ShareFile Enrollment Profiles Delivery Groups

Actions

- 1 Action Info
- 2 Details
- 3 Assignment (optional)
- 4 Summary**

Summary ✕

Review your settings, and then save or deploy this action.

General

Name HDX blocked notification

Description HDX blocked notification because device is out of compliance

Action details

If device has been marked as Out of Compliance, then notify using the template "HDX Application Block" immediately.

Assignment

Delivery groups AllUsers

9. Click **Next** and then click **Save**.

For more information on setting automated actions, see [Automated actions](#).

Users can gain access to HDX apps again after the device is brought back into compliance:

1. On the device, go to the Secure Hub store to refresh the apps in the store.
2. Go to the app and tap **Add** to the app.

After the app is added, it appears in My Apps with a blue dot next to it, because it is a newly installed app.

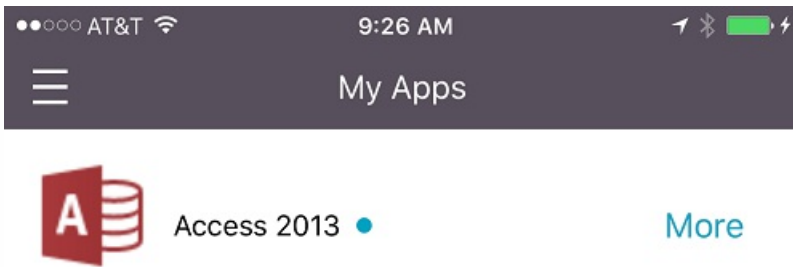

Deploy resources

Aug 17, 2017

Device configuration and management typically involve creating resources (policies and apps) and actions in the XenMobile console and then packaging them using delivery groups. The order in which XenMobile pushes resources and actions in a delivery group to devices is referred to as the *deployment order*. This article describes how:

- To add, manage, and deploy delivery groups
- To change the deployment order of resources and actions in delivery groups
- XenMobile determines deployment order when a user is in multiple delivery groups that have duplicate or conflicting policies.

Delivery groups specify the category of users to whose devices you deploy combinations of policies, apps, and actions. Inclusion in a delivery group is typically based on user characteristics, such as company, country, department, office address, and title. Delivery groups give you greater control over who gets what resources and when they get them. You can deploy a delivery group to everyone or to a more narrowly defined group of users.

Deploying to a delivery group means sending a push notification to all users with iOS, Windows Phone, and Windows tablet devices. Those users must belong to the delivery group to reconnect to XenMobile. In this way, you can reevaluate the devices and deploy apps, policies, and actions. For users with other platform devices: If they are already connected, they receive the resources immediately. Otherwise, based on their scheduling policy, they receive resources the next time that they connect.

The default AllUsers delivery group is created when you install and configure XenMobile. It contains all local users and Active Directory users. You cannot delete the AllUsers group, but you can disable the group when you do not want to push resources to all users.

Deployment Ordering

Deployment order is the sequence in which XenMobile pushes resources to devices. Deployment order is supported only for MDM mode.

When determining deployment order, XenMobile applies filters and control criteria, such as deployment rules and deployment schedule, to policies, apps, actions, and delivery groups. Before adding delivery groups, consider how the information in this section relates to your deployment goals.

Here's a summary of the main concepts related to deployment order:

- **Deployment order:** The sequence in which XenMobile pushes resources (policies and apps) and actions to a device. Deployment order for some policies, such as Terms and Conditions and Software Inventory, has no effect on other resources. The order in which actions are deployed has no effect on other resources, so their position is ignored when XenMobile deploys the resources.
- **Deployment rules:** XenMobile uses the deployment rules that you specify for device properties to filter policies, apps, actions, and delivery groups. For example, a deployment rule might specify to push the deployment package when a domain name matches a particular value.
- **Deployment schedule:** XenMobile uses the deployment schedule that you specify for actions, apps, and device policies to control deployment of those items. You can specify that a deployment occurs immediately, on a particular date and

time, or according to deployment conditions.

The following table shows those and other criteria that you can associate with specific objects or resources to filter them or control their deployment.

Object/Resource	Filter/Control Criteria
Device policy	Device platform Deployment rule (based on device properties) Deployment schedule
App	Device platform Deployment rule (based on device properties) Deployment schedule
Action	Deployment rule (based on device properties) Deployment schedule
Delivery group	User/Groups Deployment rule (based on device properties)

It is very likely that, in a typical environment, multiple delivery groups become assigned to a single user, with the following possible results:

- Duplicate objects exist within the delivery groups.
- A specific policy is configured differently in more than one delivery group that is assigned to a user.

When either of those situations occur, XenMobile calculates a deployment order for all the objects that it must deliver to a device or act upon. The calculation steps are independent of the device platform.

Calculation steps:

1. Determine all the delivery groups for a specific user, based on the filters of users, groups, and deployment rules.
2. Create an ordered list of all resources (policies, actions, and apps) within the selected delivery groups. The list is based on the filters of device platform, deployment rules, and deployment schedule. The ordering algorithm is as follows:
 - a. Place resources from delivery groups that have a user-defined deployment order ahead of resources from delivery groups without one. The rationale for this placement is described after these steps.
 - b. As a tie-breaker among delivery groups, order resources from delivery groups by delivery group name. For example, place resources from delivery group A ahead of resources from delivery group B.

c. While sorting, if a user-defined deployment order is specified for resources of a delivery group, maintain that order. Otherwise, sort the resources within that delivery group by resource name.

d. If the same resource appears more than once, then remove the duplicate resource.

Resources that have a user-defined order associated with them deploy before resources without a user-defined order. A resource can exist in multiple delivery groups assigned to user. As indicated in the steps above, the calculation algorithm removes redundant resources and only delivers the first resource in this list. By removing duplicate resources in that way, XenMobile enforces the order defined by the XenMobile administrator.

For example, suppose that you have two delivery groups as follows:

- Delivery group, Account Managers 1: With **unspecified** order for resources. Contains the policies **WiFi** and **Passcode**.
- Delivery group, Account Managers 2: With **specified** order for resources. Contains the policies **Connection scheduling**, **Restrictions**, **Passcode**, and **WiFi**. In this case, you want to deliver the **Passcode** policy before the **WiFi** policy.

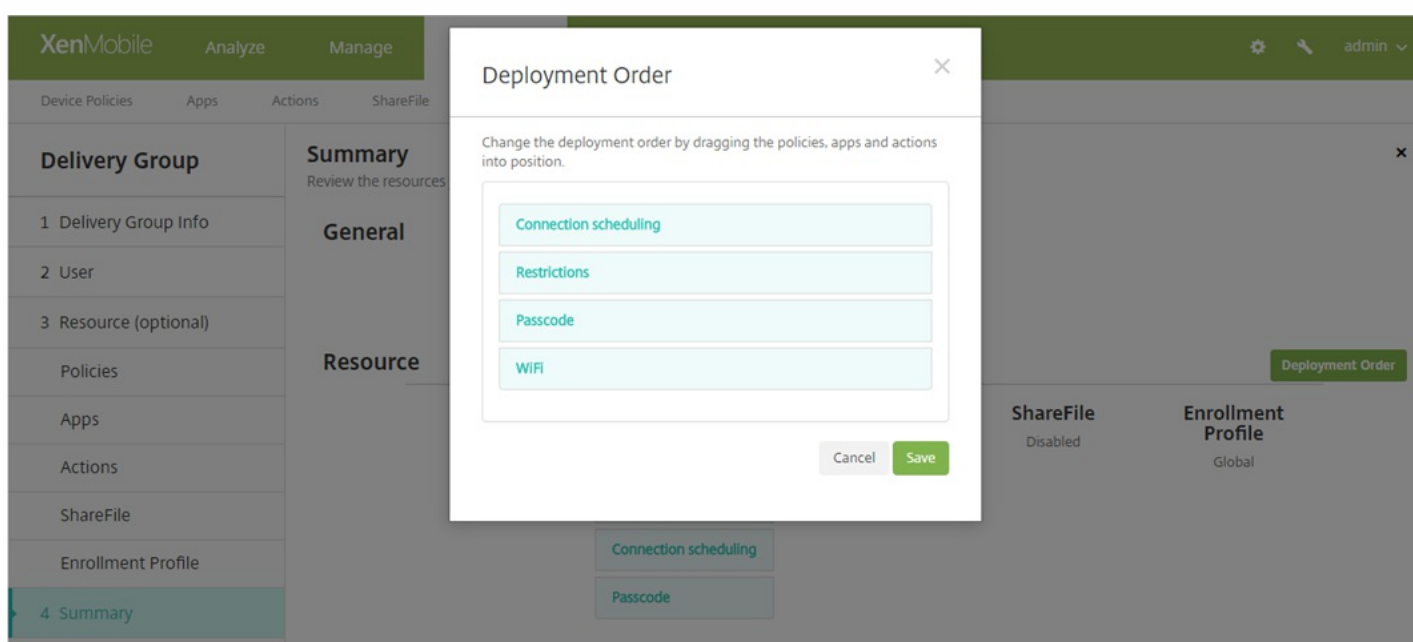

If the calculation algorithm ordered deployment groups only by name, XenMobile would perform the deployment in this order, starting with the delivery group Account Managers 1: **WiFi**, **Passcode**, **Connection scheduling**, and **Restrictions**. XenMobile would ignore **Passcode** and **WiFi**, both duplicates, from the Account Managers 2 delivery group.

However, the Account Managers 2 group has an admin-specified deployment order. Therefore, the calculation algorithm places resources from the Account Managers 2 delivery group higher in the list than the resources from the other delivery group. As a result, XenMobile deploys the policies in this order: **Connection scheduling**, **Restrictions**, **Passcode**, and **WiFi**. XenMobile ignores the policies **WiFi** and **Passcode** from the Account Managers 1 delivery group, because they are duplicates. That algorithm therefore respects the order specified by the XenMobile administrator.

1. In the XenMobile console, click **Configure > Delivery Groups**. The **Delivery Groups** page appears.

Delivery Groups [Show filter](#)

[Add](#) | [Export](#)

<input type="checkbox"/>	Status	Name	Last Updated	Disabled
<input type="checkbox"/>		AllUsers		
<input type="checkbox"/>		Domain users	Jun 13 2016 5:10 PM	
<input type="checkbox"/>		Sales	Apr 13 2016 12:50 PM	

2. From the **Delivery Groups** page, click **Add**. The **Delivery Group Information** page appears.

Delivery Group Information ×

Enter a name for the delivery group and any information that will help you keep track of it later.

Name

Description

Delivery Group

- 1 Delivery Group Info
- 2 User
- 3 Resource (optional)
- Policies
- Apps
- Actions
- ShareFile
- Enrollment Profile
- 4 Summary

3. In the **Delivery Group Information** page, enter the following information:

- **Name:** Type a descriptive name for the delivery group.
- **Description:** Type an optional description of the delivery group.

4. Click **Next**. The **User Assignments** page appears.

The screenshot displays the XenMobile configuration interface. The top navigation bar includes 'XenMobile', 'Analyze', 'Manage', and 'Configure'. Below this, a secondary navigation bar lists 'Device Policies', 'Apps', 'Actions', 'ShareFile', 'Enrollment Profiles', and 'Delivery Groups'. The 'Delivery Groups' section is active, showing a left-hand navigation pane with options: '1 Delivery Group Info', '2 User' (highlighted), '3 Resource (optional)', 'Policies', 'Apps', 'Actions', 'ShareFile', 'Enrollment Profile', and '4 Summary'. The main content area is titled 'User Assignments' and contains the following controls:

- Select domain:** A dropdown menu currently showing 'local'.
- Include user groups:** A search input field with a magnifying glass icon and a blue 'Search' button to its right.
- Selected user groups:** A large, empty rectangular box intended for displaying the results of the search.
- Logic:** Two radio buttons labeled 'Or' (which is selected) and 'And'.
- Deploy to anonymous user:** A toggle switch currently set to 'OFF'.
- Deployment Rules:** A section header with a right-pointing arrow, partially visible at the bottom.

5. Configure these settings:

- **Select domain:** From the list, select the domain from which to choose users.
- **Include user groups:** Do one of the following:
 - In the list of user groups, click the groups you want to add. The selected groups appear in the **Selected user groups** list.
 - Click **Search** to see a list of all user groups in the selected domain.
 - Type a full or partial group name in the search box, and then click **Search** to limit the list of user groups.
 - To remove a user group from the **Selected user groups** list, do one of the following:
 - In the **Selected user groups** list, click the X next to each of the groups you want to remove.
 - Click **Search** to see a list of all user groups in the selected domain. Scroll through the list and clear the check box of each of the groups you want to remove.
 - Type a full or partial group name in the search box, and then click **Search** to limit the list of user groups. Scroll through the list and clear the check box of each of the groups you want to remove.
- **Or/And:** Select whether users may be in any group (Or) or whether they must be in all groups (And) for the resource to be deployed to them.
- **Deploy to anonymous user:** Select whether to deploy to unauthenticated users in the delivery group.

Note: Unauthenticated users are users whom you were not able to authenticate, but you allowed their devices to connect to XenMobile anyway.

6. Configure the deployment rules

You can add optional resources to delivery groups to:

- Apply specific policies
- Provide required and optional apps
- Add automatic actions
- Enable ShareFile for single-sign on to content and data

The following sections describe how to add policies, apps, actions, and how to enable ShareFile. You can add any, all, or none of these resources to the delivery group. To skip adding a resource, click **Summary**.

Add policies

1. For each policy you want to add, do the following:

- Scroll through the list of available policies to find the policy you want to add.
- Or, to limit the list of policies, type a full or partial policy name in the search box, and then click **Search**.
- Click the policy you want to add and drag it into the box on the right.

Note: To remove a policy, click the X next to the policy name in the box on the right.

The screenshot shows the XenMobile interface. The top navigation bar includes 'XenMobile', 'Analyze', 'Manage', and 'Configure'. Below this, there are tabs for 'Device Policies', 'Apps', 'Actions', 'ShareFile', 'Enrollment Profiles', and 'Delivery Groups'. The 'Configure' tab is active, and the 'Delivery Groups' sub-tab is selected. On the left, a sidebar lists 'Delivery Group' options: '1 Delivery Group Info', '2 User', '3 Resource (optional)', 'Policies' (highlighted), 'Apps', 'Actions', 'ShareFile', 'Enrollment Profile', and '4 Summary'. The main content area is titled 'Policies' and contains the instruction 'Drag the policies that you want to include in the delivery group.' Below this is a search box with the placeholder 'Enter policy name' and a 'Search' button. A dropdown menu labeled 'Policies' is open, showing a list of policy options: 'WIFI', 'Passcode', 'Connection scheduling', 'Restrictions', and 'Launcher Configuration'. A hand icon with an arrow points from the 'WIFI' policy towards a large empty box on the right, indicating the drag-and-drop action.

2. Click **Next**. The **Apps** page appears.

Add apps

1. For each app you want to add, do the following:

- Scroll through the list of available apps to find the app you want to add.

- Or, to limit the list of apps, type a full or partial app name in the search box, and then click **Search**.
- Click the app you want to add and drag it into either the **Required Apps** box or the **Optional Apps** box.

For apps marked as required, users can promptly receive updates in situations such as:

- You upload a new app and mark it as required.
- You mark an existing app as required.
- As user deletes a required app.
- A Secure Hub update is available.

To enable that feature, create a Custom Key server property. Set the **Key** and **Display name** to **force.server.push.required.apps** and set the **Value** to **true**.

Required app forced deployment requires these minimum versions:

- XenMobile Server 10.6
- Secure Hub 10.5.15 for iOS and 10.5.20 for Android
- MDX Toolkit 10.6

Enterprise apps upgrade immediately even if you set an App update grace period and the user taps to upgrade the app later.

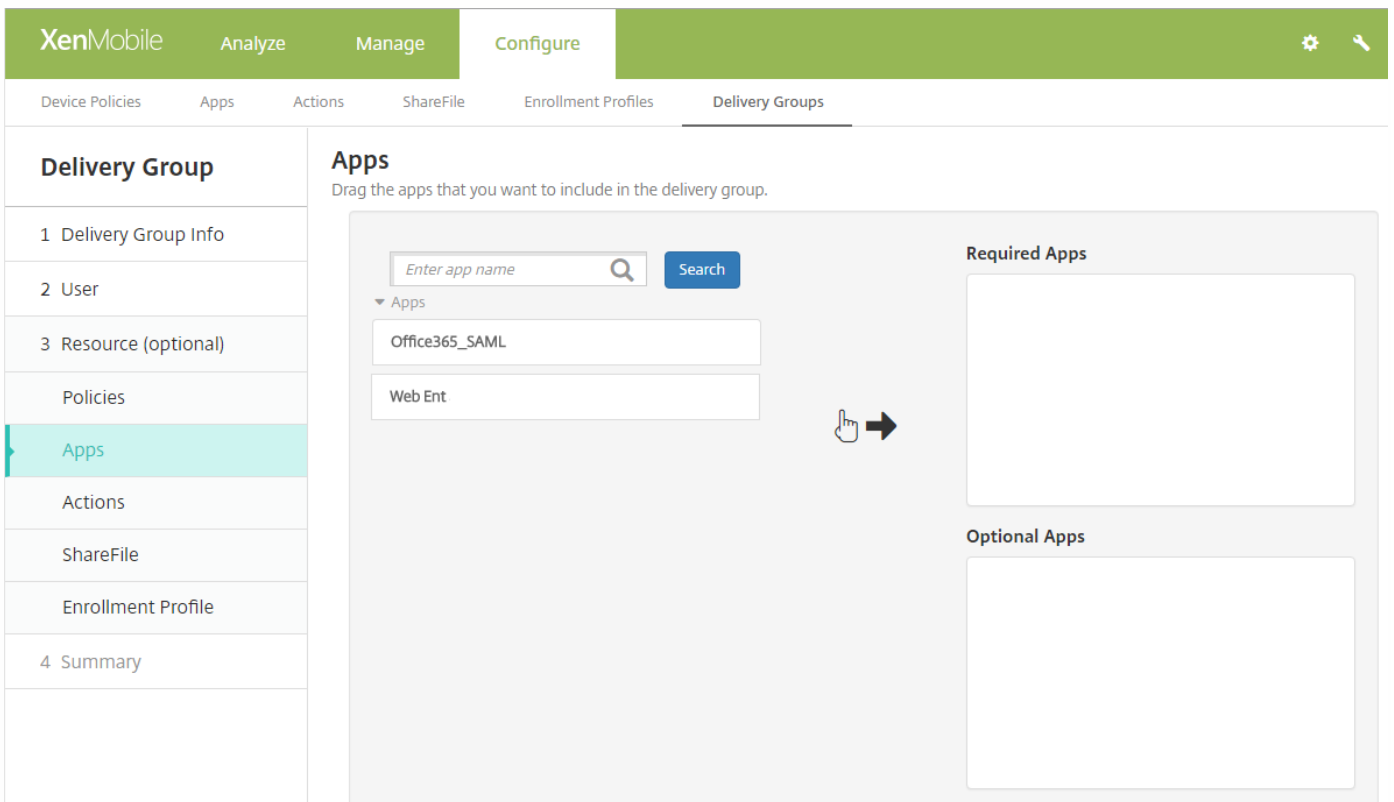

For apps marked as required, users promptly receive updates in situations such as:

- You upload a new app and mark it as required.

- You mark an existing app as required.
- As user deletes a required app.
- A Secure Hub update is available.

To remove an app, click the X next to the app name in the box on the right.

2. Click **Next**. The **Actions** page appears.

Add actions

1. For each action you want to add, do the following:

- Scroll through the list of available actions to find the action you want to add.
- Or, to limit the list of actions, type a full or partial action name in the search box, and then click **Search**.
- Click the action you want to add and drag it into the box on the right.

Note: To remove an action, click the X next to the action name in the box on the right.

The screenshot shows the XenMobile interface. At the top, there is a navigation bar with 'XenMobile' and tabs for 'Analyze', 'Manage', and 'Configure'. Below this is a sub-navigation bar with 'Device Policies', 'Apps', 'Actions', 'ShareFile', 'Enrollment Profiles', and 'Delivery Groups'. The 'Delivery Groups' tab is active, showing a sidebar with 'Delivery Group' and a list of steps: '1 Delivery Group Info', '2 User', '3 Resource (optional)', 'Policies', 'Apps', 'Actions' (highlighted), 'ShareFile', 'Enrollment Profile', and '4 Summary'. The main content area is titled 'Actions' and contains the instruction 'Drag the actions that you want to include in the delivery group.' Below this is a search box with the placeholder 'Enter action name' and a 'Search' button. A dropdown menu shows two actions: 'Action - Out of compliance' and 'Action - Send notification'. A hand icon with an arrow points to the right, indicating a drag-and-drop action.

2. Click **Next**. The **ShareFile** page appears.

Apply the ShareFile configuration

The ShareFile page differs depending on whether you configured XenMobile (Configure > ShareFile) for ShareFile Enterprise or for StorageZone Connectors.

If you configured ShareFile Enterprise for use with XenMobile: Set **Enable ShareFile** to **ON** to provide the delivery group single sign-on access to ShareFile content and data.

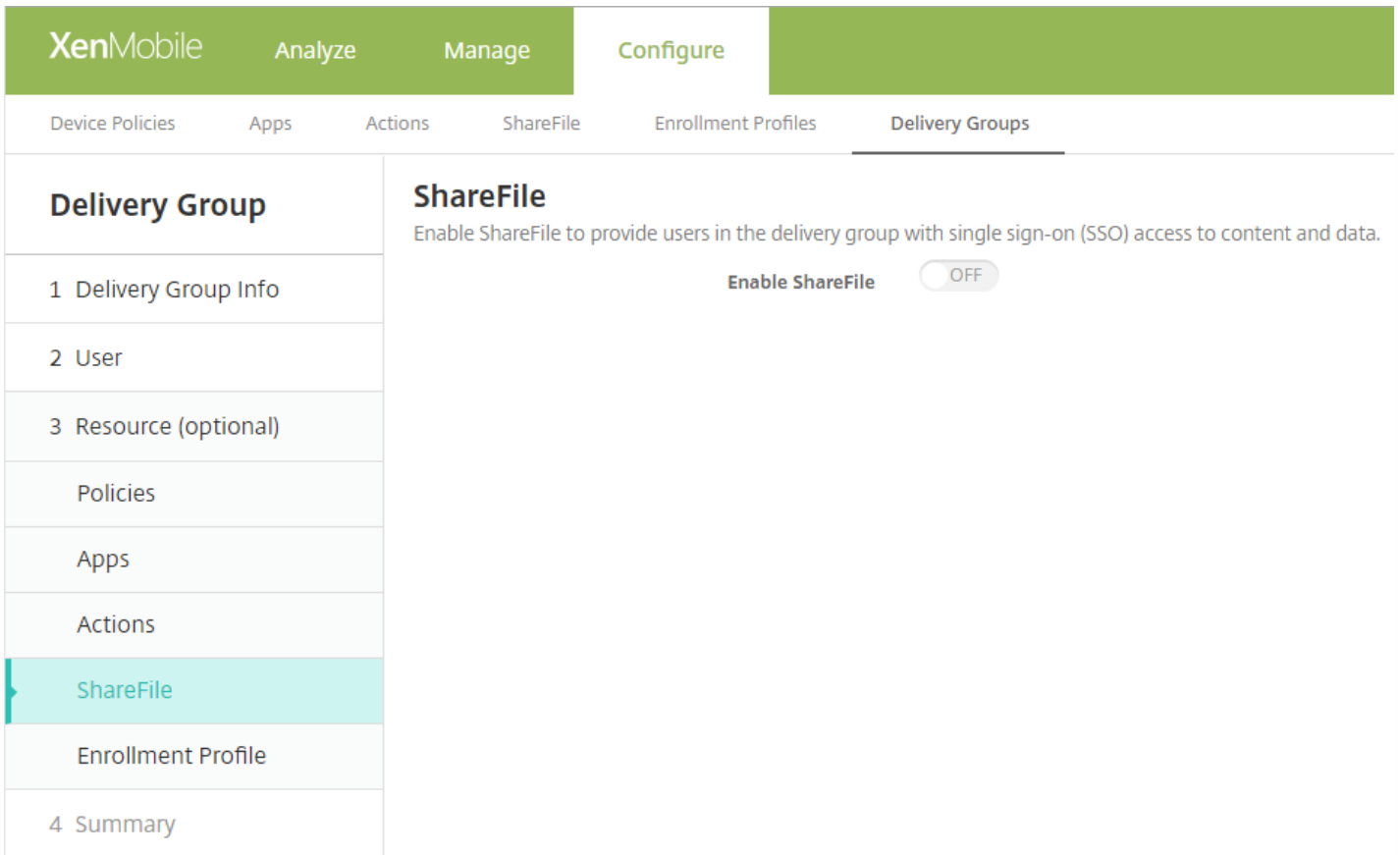

If you configured StorageZone Connectors for use with XenMobile, select the StorageZone Connectors to include in the delivery group.

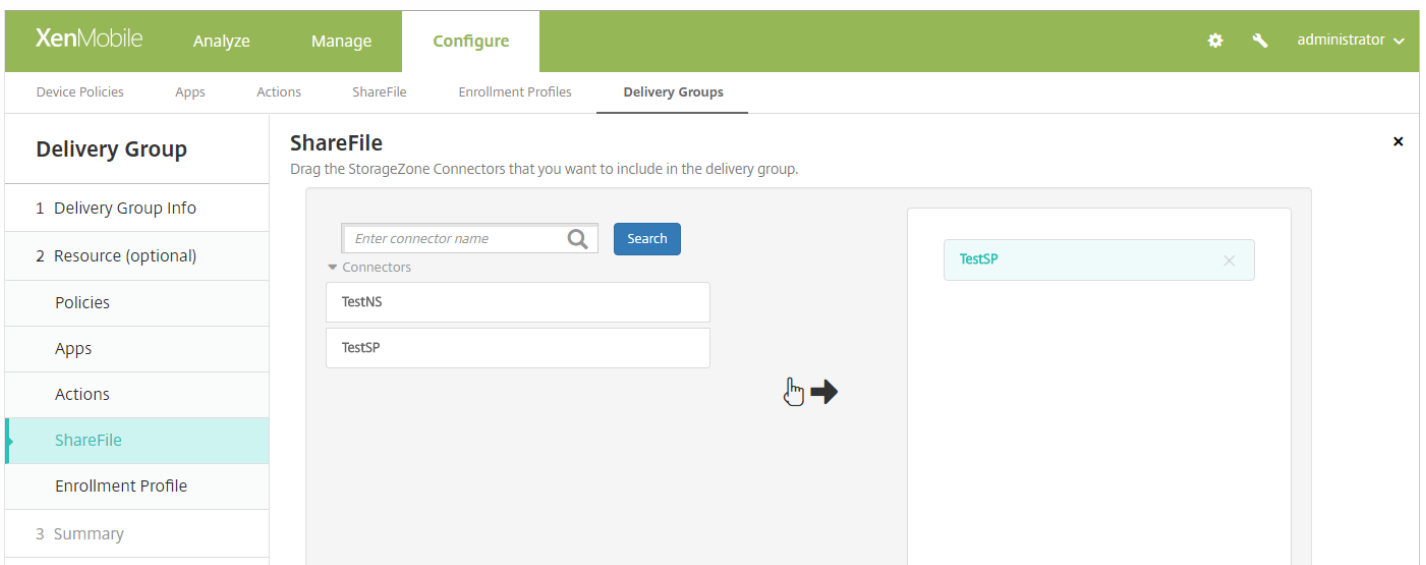

XenMobile Analyze Manage **Configure**

Device Policies Apps Actions ShareFile Enrollment Profiles **Delivery Groups**

Delivery Group

- 1 Delivery Group Info
- 2 Resource (optional)
 - Policies
 - Apps
 - Actions
 - ShareFile
 - Enrollment Profile**
- 3 Summary

Enrollment Profile

Select the enrollment profile that you want the users in this delivery group to see

Enrollment Profile Global

1. Configure this setting:

- **Enrollment Profile:** Select an Enrollment Profile. To create an enrollment profile, see [Device enrollment limit](#).

2. Click **Next**. The **Summary** page appears.

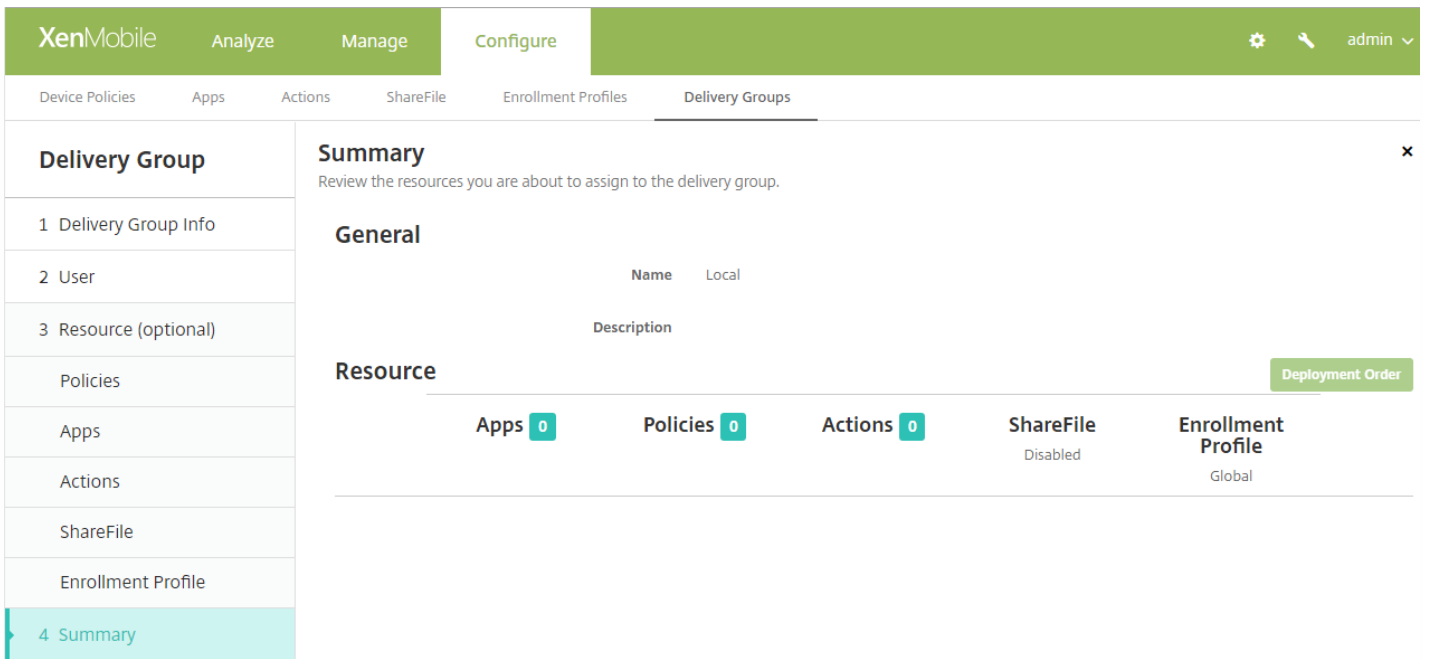

On the **Summary** page, you can review the options you have configured for the delivery group and change the deployment order of resources. The Summary page shows your resources by category. The Summary page doesn't reflect the deployment order.

1. Click **Back** to return to previous pages to make any necessary adjustments to the configuration.
2. Click **Deployment Order** to view the deployment order or to reorder the deployment order.
3. Click **Save** to save the delivery group.

1. Click the **Deployment Order** button. The **Deployment Order** dialog box appears.

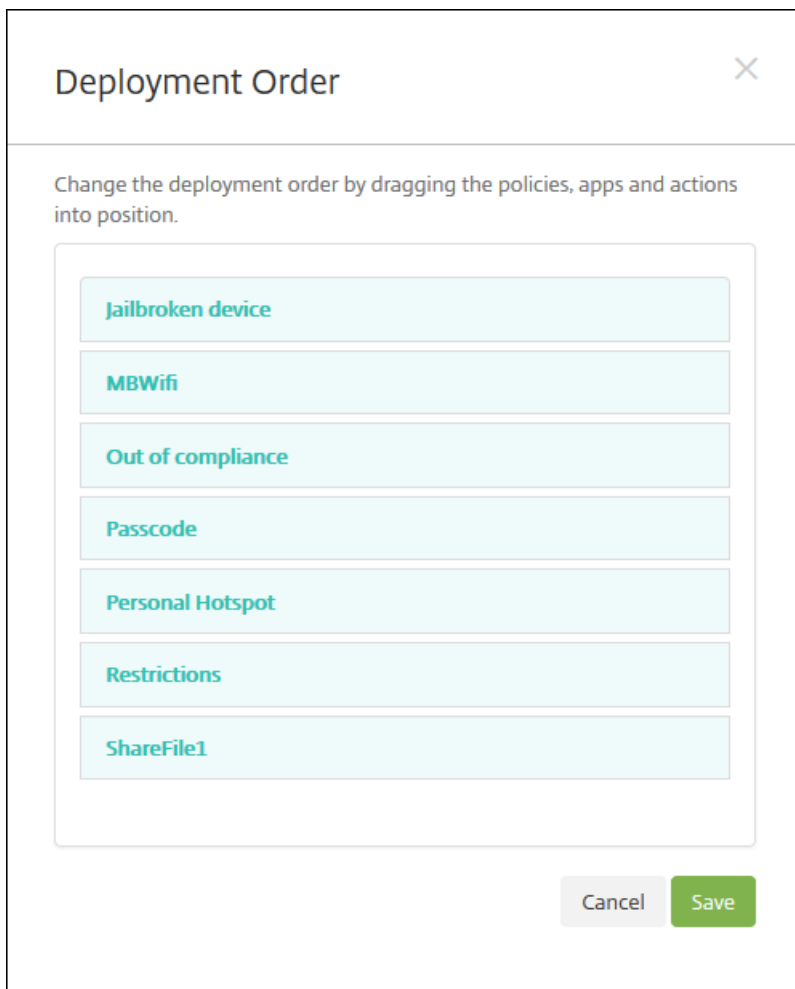

2. Click on a resource and drag it to the location from which you want it deployed. After you change the deployment order, XenMobile deploys resources in the list from top to bottom.

3. Click **Save** to save the deployment order.

1. Choose the delivery group you want to edit: On the **Delivery Groups** page, select the check box for the delivery group or click the delivery group line, and then click **Edit**. The **Delivery Group Information** page appears.

Note

Depending on how you selected the delivery group, the **Edit** command appears above or to the right of the delivery group.

2. Add or change the **Description**.

Note: You cannot change the name of an existing delivery group.

3. Click **Next**. The **User Assignments** page appears.

The screenshot shows the XenMobile configuration interface. At the top, there are tabs for 'Analyze', 'Manage', and 'Configure'. Below these are sub-tabs for 'Device Policies', 'Apps', 'Actions', 'ShareFile', 'Enrollment Profiles', and 'Delivery Groups'. The 'Delivery Groups' sub-tab is active, showing a 'Delivery Group' configuration page. On the left, a navigation pane lists steps: '1 Delivery Group Info', '2 User' (highlighted), '3 Resource (optional)', 'Policies', 'Apps', 'Actions', 'ShareFile', 'Enrollment Profile', and '4 Summary'. The main area is titled 'User Assignments' and contains the following controls:

- Select domain:** A dropdown menu currently set to 'local'.
- Include user groups:** A search box with a magnifying glass icon and a blue 'Search' button to its right.
- Logic:** Two radio buttons labeled 'Or' (selected) and 'And'.
- Deploy to anonymous user:** A toggle switch currently set to 'OFF'.
- Deployment Rules:** A section header with a right-pointing arrow.

4. In the **Select User Groups** page, enter or change the following information:

- **Select domain:** In the list, select the domain from which to choose users.
- **Include user groups:** Do one of the following:
 - In the list of user groups, click the groups you want to add. The selected groups appear in the **Selected user groups** list.
 - Click **Search** to see a list of all user groups in the selected domain.
 - Type a full or partial group name in the search box, and then click **Search** to limit the list of user groups.

Note: To remove user groups: Click **Search**, and then in the list of user groups, clear the check box next to the group or groups. To limit the number of user groups displayed in the list: Type a full or partial group name in the search box and then click **Search**.

- **Or/And:** Select whether users may be in any group (Or) or whether they must be in all groups (And) for deployment.
- **Deploy to anonymous user:** Select whether to deploy to unauthenticated users in the delivery group.

Note: Unauthenticated users are users whom you were not able to authenticate, but whose devices you allowed to connect to XenMobile.

5. Expand **Deployment Rules** and then configure the settings as you did in Step 5 earlier in this procedure.

6. Click **Next**. The **Delivery Group Resources** page appears. Add or delete policies, apps, or actions here. To skip this step,

under **Delivery Group**, click **Summary** to see a summary of the delivery group configuration.

7. When you are done modifying a resource, click **Next**, or under **Delivery Group**, click **Summary**.

8. On the **Summary** page, you can review the options you have configured for the delivery group and change the deployment order of resources.

9. Click **Back** to return to previous pages to make any necessary adjustments to the configuration.

10. Click **Deployment Order** to reorder the resource deployment order; for more information on changing deployment order, see [To change deployment order](#).

11. Click **Save** to save the delivery group.

Note

AllUsers is the only delivery group that you can enable or disable.

1. From the **Delivery Groups** page, choose the AllUsers delivery group by selecting the check box next to **AllUsers** or by clicking in the line containing AllUsers. Then do one of the following:

Note: Depending on how you selected AllUsers, the **Enable** or **Disable** command appears above or to the right of the AllUsers delivery group.

- Click **Disable** to disable the AllUsers delivery group. This command is only available if AllUsers is enabled (the default). **Disabled** appears under the **Disabled** heading in the delivery group table.
- Click **Enable** to enable the AllUsers delivery group. This command is only available if AllUsers is disabled. **Disabled** disappears from under the **Disabled** heading in the delivery group table.

Deploying to a delivery group means sending a push notification to all users with iOS, Windows Phone, and Windows tablet devices. Those users must belong to the delivery group to reconnect to XenMobile. In that way, you can reevaluate the devices and deploy apps, policies, and actions. For users with other platform devices: If those devices are already connected to XenMobile, they receive the resources immediately. Otherwise, based on their scheduling policy, they receive the resources the next time that they connect.

Note: For updated apps to appear in the Updated Available list in the XenMobile Store on Android devices: First deploy an App Inventory policy to the user devices.

1. On the **Delivery Groups** page, do one of the following:

- To deploy to more than one delivery group at a time, select the check boxes next to the groups you want to deploy.
- To deploy to a single delivery group, either select the check box next to its name or click the line containing its name.

2. Click **Deploy**.

Note: Depending on how you select a single delivery group, the **Deploy** command appears above or to the right of the delivery group.

Verify that the groups to which you want to deploy apps, policies, and actions are listed and then click **Deploy**. The apps, policies, and actions are deployed to the selected groups based on device platform and scheduling policy.

You can check deployment status on the **Delivery Groups** page in one of these ways:

- Look at the deployment icon under the **Status** heading for the delivery group, which indicates any deployment failure.
- Click the line containing the delivery group to display an overlay that indicates **Installed**, **Pending**, and **Failed** deployments.

The screenshot shows the 'Delivery Groups' interface. At the top, there is a search bar and a 'Show filter' link. Below the search bar are 'Add' and 'Export' buttons. A table lists three delivery groups: 'AllUsers', 'sales', and 'DG for CAT'. The 'sales' group is highlighted in light blue and has a deployment icon (a square with a play symbol) in the 'Status' column. A purple box highlights the 'Status' column header and the deployment icons for all three groups. An overlay window is open for the 'sales' group, showing 'Edit', 'Deploy', and 'Delete' buttons. Below these buttons is a 'Deployment' summary box with three colored boxes: a green box with '1 Installed', a light blue box with '0 Pending', and an orange box with '0 Failed'. A 'Show more >' link is at the bottom of the overlay. The text 'Showing 1 - 3 of 3 items' is visible at the bottom left of the table area.

Note

You cannot delete the AllUsers delivery group, but you can disable the group when you do not want to push resources to all users.

1. On the **Delivery Groups** page, do one of the following:

- To delete more than one delivery group at a time, select the check boxes next to the groups you want to delete.
- To delete a single delivery group, either select the check box next to its name or click the line containing its name.

2. Click **Delete**. The **Delete** dialog box appears.

Note: Depending on how you select a single delivery group, the **Delete** command appears above or to the right of the delivery group.

3. Click **Delete**.

Important

You cannot undo this action.

1. Click the **Export** button above the **Delivery Groups** table. XenMobile extracts the information in the **Delivery Groups** table and converts it to a .csv file.
2. Open or save the .csv file by following the usual steps for your browser. You can also cancel the operation.

Macros

Jun 19, 2017

XenMobile provides macros as a way to populate user or device property data within the text field of the following items:

- Policies
- Notifications
- Enrollment templates
- Automated actions
- Credential provider Certificate Signing Requests

XenMobile replaces a macro with the corresponding user or system values. For example, by using macros you can prepopulate the mailbox value for a user in a single Exchange profile across thousands of users.

Macros are available only for iOS and Android devices.

Defining user macros

The following user macros are always available:

- loginname (username plus domainname)
- username (loginname minus the domain, if any)
- domainname (domain name, or the default domain)

The following administrator-defined user properties are available if configured in LDAP. If the user is authenticated by using an authentication server, such as LDAP, all the properties associated with the user in that store are available.

- c
- cn
- company
- companyname
- department
- description
- displayname
- distinguishedname
- facsimiletelephonenumber
- givenname
- homecity
- homecountry
- homefax
- homephone
- homestate
- homestreetaddress
- homezip
- iphone
- l

- mail
- middleinitial
- mobile
- officestreetaddress
- pager
- physicaldeliveryofficename
- postalcode
- postofficebox
- telephonenumber
- samaccountname
- sn
- st
- streetaddress
- title
- userprincipalname
- domainname (overrides property described previously)

The following macros are used in the default notification templates:

- `${account.SUPPORT_EMAIL}`
- `${applicationName}`
- `${enrollment.andriod.agent.download.url}`
- `${enrollment.ios.agent.download.url}`
- `${enrollment.pin}`
- `${enrollment.url}`
- `${firstnotnull(device.TEL_NUMBER,device.serialNumber)}`
- `${firstnotnull(device.TEL_NUMBER,user.mobile)}`
- `${outofcompliance.reason(smg_block)}`
- `${outofcompliance.reason(whitelist_blacklist_apps_name)}`
- `${vpp.account}`
- `${vpp.appname}`
- `${vpp.url}`
- `${zdmserver.hostPath}/enroll`

Macro syntax

A macro can take the following form:

- `${type.PROPERTYNAME}`
- `${type.PROPERTYNAME ['DEFAULT VALUE'] [| FUNCTION [(ARGUMENT1, ARGUMENT2)]]}`

Enclose all syntax following the dollar sign (\$) in curly brackets ({ }).

- Qualified property names reference either a user property, a device property, or a custom property.
- Qualified property names consist of a prefix, followed by the actual property name.
- User properties take the form `${user.[PROPERTYNAME]}` (prefix="user.").
- Device properties take the form `${device.[PROPERTYNAME]}` (prefix="device.").
- Property names are case-sensitive.
- A function can be a limited list or a link to a third-party reference that defines functions. This macro for a notification message includes the function **firstnonnull**:

Device `${firstnonnull(device.TEL_NUMBER,device.serialNumber)}` has been blocked...

- For custom macros (properties that you define), the prefix is `${custom}`. You can omit the prefix.

Here's an example of a commonly used macro, `${user.username}`, that populates the user name value in the text field of a policy. This macro is useful for configuring Exchange ActiveSync profiles and other profiles used by multiple users. The following example shows how to use macros in an Exchange policy. The macro for **User** is `${user.username}`. The macro for **Email address** is `${user.mail}`.

The screenshot shows the XenMobile 'Configure' interface for an 'Exchange Policy'. The left sidebar lists '1 Policy Info', '2 Platforms', and '3 Assignment'. Under '2 Platforms', several operating systems are checked, including iOS, Mac OS X, Android HTC, Android TouchDown, Android for Work, Samsung SAFE, Samsung KNOX, and Windows Phone. The main configuration area for the 'Exchange Policy' includes the following fields:

- Exchange ActiveSync account name*: Exchange01
- Exchange ActiveSync host name*: exchange01.example.net
- Use SSL: ON
- Domain: example.net
- User: `${user.username}`
- Email address: `${user.mail}`
- Password:
- Email sync interval: 1 month
- Identity credential (keystore or PKI credential): None
- Authorize email move between accounts: OFF

The following example shows how to use macros for a certificate signing request. The macro for **Subject name** is `CN=${user.username}`. The macro for the **Value** of a **Subject alternative name** is `${user.userprincipalname}`.

XenMobile Analyze Manage Configure administrator

Settings > Credential Providers > Add credential provider

Credential Providers

- General
- Certificate Signing Request
- Distribution
- Revocation XenMobile
- Revocation PKI
- Renewal

Credential Providers: Certificate Signing Request

Configure the parameters for the key pair that is created during issuance, as well as the parameters of the new certificate.

Key algorithm: RSA

Key size*: 2048

Signature algorithm: SHA256withRSA

Subject name*: CN=Suser.username

Subject alternative names

Type	Value*	Add
User Principal name	Suser.userprincipalname	

The following example shows how to use macros in a notification template. The example template defines the message sent to a user when HDX applications are blocked because of a non-compliant device. The macro for the **Message** is:

Device `${firstnotnull(device.TEL_NUMBER,device.serialNumber)}` no longer complies with the device policy and HDX applications will be blocked.

XenMobile Analyze Manage Configure administrator

Settings > Notification Templates > Add Notification Template

Add Notification Template

Based on the types of templates you choose, you can notify users through supported channels, such as SMTP, SMS and Secure Hub.

Name*: HDX Application Block

Description:

Type: Ad-Hoc Notification
Manual sending supported

Channels

Secure Hub: Activate

Message: Device `${firstnotnull(device.TEL_NUMBER,device.serialNumber)}` no longer complies with the device policy and HDX applications will be blocked.

For more examples of macros used in notifications, go to **Settings > Notification Templates**, select a pre-defined template, and click **Edit**.

The following example shows a macro in the Device Name policy. You can type a macro, a combination of macros, or a combination of macros and text to name each device uniquely. For example, use `${device.serialnumber}` to set the device

names to the serial number of each device. Use `${device.serialnumber}` `${ user.username }` to include the user name in the device name.

The screenshot shows the XenMobile web interface. The top navigation bar includes 'XenMobile', 'Analyze', 'Manage', and 'Configure'. The 'Configure' section is active, with sub-tabs for 'Device Policies', 'Apps', 'Actions', 'ShareFile', 'Enrollment Profiles', and 'Delivery Groups'. The 'Device Policies' tab is selected, showing a 'Device Name Policy' configuration page. The page title is 'Device Name Policy' with a close button (x). Below the title is a description: 'This policy lets you apply a name on a supervised device on iOS and Mac OS X devices. Available in iOS 8 and later.' There is a 'Device name*' field with a text input containing the placeholder `${device.serialnumber}`. Below this is a 'Deployment Rules' section with a right-pointing arrow. On the left side, there is a sidebar with a 'Device Name Policy' header and three sections: '1 Policy Info', '2 Platforms', and '3 Assignment'. Under '2 Platforms', there are two checked items: 'iOS' and 'Mac OS X'.

Automated actions

Jul 21, 2017

You create automated actions in XenMobile to program a reaction to events, user or device properties, or the existence of apps on user devices. When you create an automated action, you establish the effect on the user's device when it is connected to XenMobile based on triggers in the action. When an event is triggered, you can send a notification to the user to correct an issue before more serious action is taken.

For example, if you want to detect an app that you have previously blacklisted (for example, Words with Friends), you can specify a trigger that sets the user's device out of compliance when Words with Friends is detected on their device. The action then notifies them that they must remove the app to bring their device back into compliance. You can set a time limit for how long to wait for the user to comply before taking more serious action, such as selectively wiping the device.

In cases in which a user's device is put into an out of compliance state, and then the user fixes the device so that the device is in compliance, you will need to configure a policy to deploy a package that resets the device into a compliant state.

The effects that you set to happen automatically range from the following:

- Fully or selectively wiping the device.
- Setting the device to out of compliance.
- Revoking the device.
- Sending a notification to the user to correct an issue before more severe action is taken.

This article explains how to add, edit, and filter automated actions in XenMobile, as well as how to configure app lock and app wipe actions for MAM-only mode.

Note

Before you can notify users, you must have configured notification servers in Settings for SMTP and SMS so that XenMobile can send the messages, see [Notifications in XenMobile](#). Also, set up any notification templates you plan to use before proceeding. For details about setting up notification templates, see [To create or update notification templates in XenMobile](#).

1. From the XenMobile console, click **Configure > Actions**. The **Actions** page appears.

2. On the **Actions** page, do one of the following:

- Click **Add** to add a new action.
- Select an existing action to edit or delete. Click the option you want to use.

Note: When you select the check box next to an action, the options menu appears above the action list; when you click anywhere else in the list, the options menu appears on the right side of the listing.

3. The **Action Information** page appears.

4. On the **Action Information** page, enter or modify the following information:

- **Name:** Type a name to uniquely identify the action. This field is required.
- **Description:** Describe what the action is meant to do.

5. Click **Next**. The **Action details** page appears.

Note: The following example shows how to set up an **Event** trigger. If you select a different trigger, the resulting options will be different from those shown here.

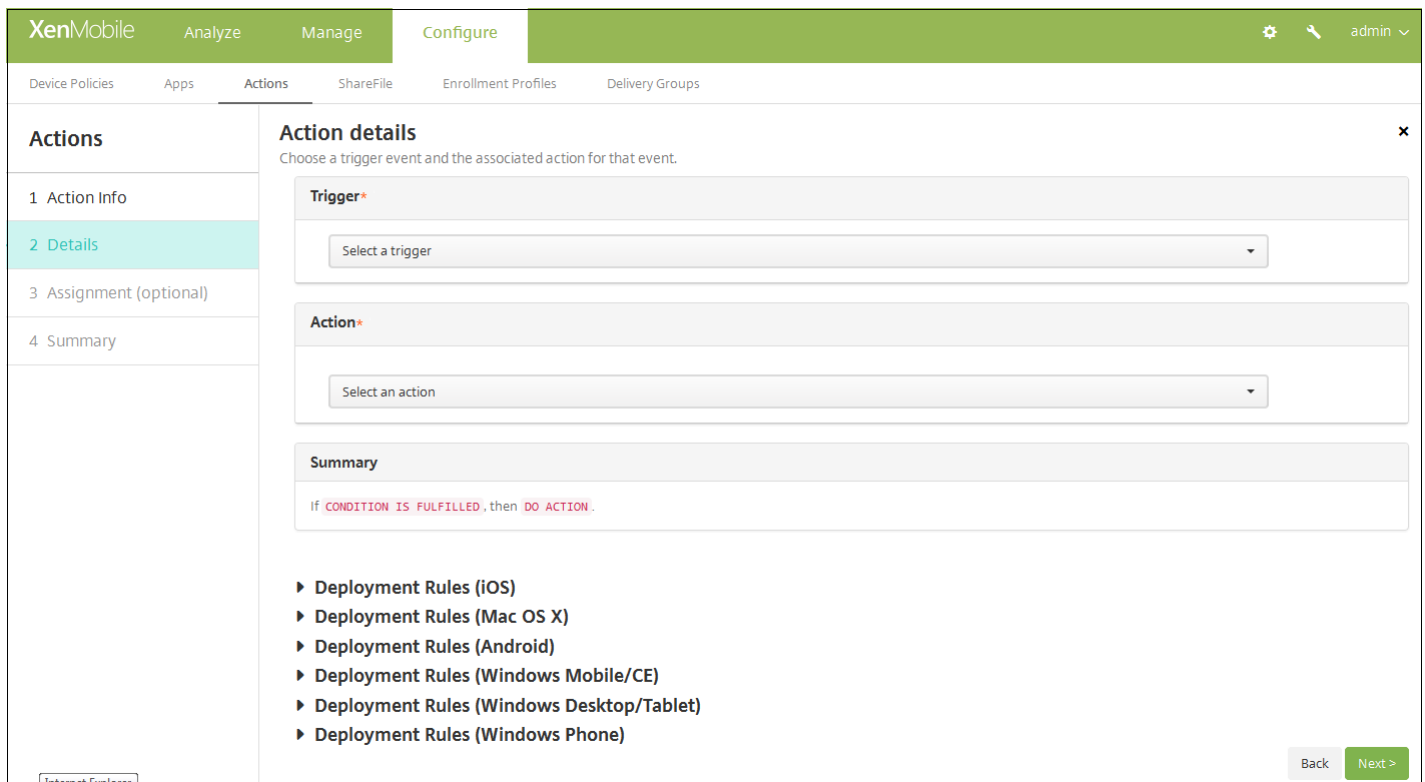

6. On the **Action details** page, enter or modify the following information:

- In the **Trigger** list, click the event trigger type for this action. The meaning of each trigger is as follows:
 - **Event:** Reacts to a predefined event.
 - **Device property:** Checks for a device attribute on the device gathered in MDM mode and reacts to it.
 - **User property:** Reacts to a user attribute, usually from Active Directory.
 - **Installed app name:** Reacts to an app being installed. Doesn't apply to MAM-only mode. Requires the app inventory policy to be enabled on the device. The app inventory policy is enabled on all platforms by default. For details, see [To add an app inventory device policy](#).

7. In the next list, click the response to the trigger.

8. In the **Action** list, click the action to be performed when the trigger criterion is met. Except for **Send notification**, you choose a time frame in which users can resolve the issue that caused the trigger. If the issue isn't resolved within that time frame, the selected action is taken. For a definition of the actions, see [Security actions](#).

If you pick **Send notification**, the remainder of this procedure explains how to send a notification action.

9. In the next list, select the template to use for the notification. Notification templates relevant to the selected event appear, unless a template doesn't yet exist for the notification type. In that case, you are prompted to configure a template with the message: No template for this event type. Create template using [Notification Template](#) in **Settings**.

Note: Before you can notify users, you must have configured notification servers in Settings for SMTP and SMS so that

XenMobile can send the messages, see [Notifications in XenMobile](#). Also, set up any notification templates you plan to use before proceeding. For details on setting up notification templates, see [To create or update notification templates in XenMobile](#).



Note: After you select the template, you can preview the notification by clicking **Preview notification message**.

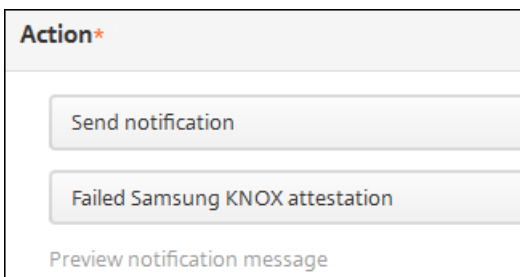

10. In the following fields, set the delay in days, hours, or minutes before taking action and the interval at which the action repeats until the user addresses the triggering issue.



11. In **Summary**, verify that you created the automated action as you intended.

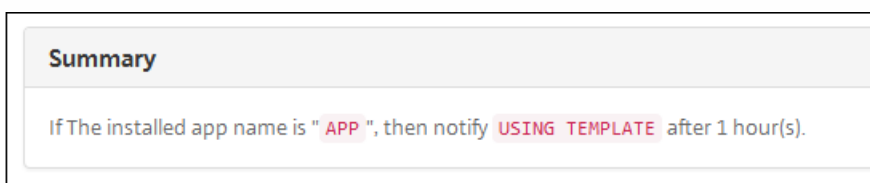

12. After you configure the action details, you can configure deployment rules for each platform individually. To do so, complete step 13 for each platform you choose.

13. Configure deployment rules

14. When you are done configuring the platform deployment rules for the action, click **Next**. The **Actions assignment** page appears, where you assign the action to a delivery group or groups. This step is optional.

15. Next to **Choose delivery groups**, type to find a delivery group or select a group or groups in the list to which you want to assign the policy. The groups you select appear in the right-hand **Delivery groups to receive app assignment** list.

16. Expand Deployment Schedule and then configure the following settings:

- Next to **Deploy**, click **ON** to schedule deployment or click **OFF** to prevent deployment. The default option is **ON**. If you choose **OFF**, no other options need to be configured.
- Next to **Deployment schedule**, click **Now** or **Later**. The default option is **Now**.
- If you click **Later**, click the calendar icon and then select the date and time for deployment.
- Next to **Deployment condition**, click **On every connection** or click **Only when previous deployment has failed**. The default option is **On every connection**.
- Next to **Deploy for always-on connection**, click **ON** or **OFF**. The default option is **OFF**.
Note: This option applies when you have configured the scheduling background deployment key in **Settings > Server Properties**. The always-on option is not available for iOS devices.

Note: The deployment schedule you configure is the same for all platforms. Any changes you make apply to all platforms, except for **Deploy for always on connection**, which does not apply to iOS.

17. Click **Next**. The **Summary** page appears, where you can verify the action configuration.

18. Click **Save** to save the action.

App lock and App wipe actions for MAM-only mode

You can wipe or lock apps on a device in response to all four categories of triggers listed in the XenMobile console: event, device property, user property and installed app name.

To configure automatic app wipe or app lock

1. In the XenMobile console, click **Configure > Actions**.
2. On the **Actions** page, click **Add**.
3. On the **Action Information** page, enter a name for the action and an optional description.
4. On the **Action Details** page, select the trigger you want.
5. In **Action**, select an action.

For this step, keep the following conditions in mind:

When the trigger type is **Event** and the value is not **Active Directory disabled user**, the **App wipe** and **App lock** actions will not appear.

When the trigger type is **Device property** and the value is **MDM lost mode enabled**, the following actions will not appear:

- Selectively wipe the device
- Completely wipe the device
- Revoke the device

For each option, a 1 hour delay is automatically set, but you can select the delay period in minutes, hours or days. The delay gives users time to fix an issue if possible before the action is carried out. You can learn more about the App wipe and App lock actions in the topic on [Configure roles with RBAC](#).

Note

If you set the trigger to **event**, the repeat interval is automatically a minimum of 1 hour. The device must carry out a refresh of the policies to synchronize with the server for the notification to come in. Typically, a device synchronizes with the server when users sign on or manually refresh their policies through Secure Hub.

An additional delay of approximately 1 hour may occur before any action is carried out, to allow the Active Directory database to synchronize with XenMobile.

The screenshot shows the XenMobile web interface. The top navigation bar includes 'XenMobile', 'Analyze', 'Manage', 'Configure', and 'Administrator'. Below this, a secondary navigation bar lists 'Device Policies', 'Apps', 'Actions', 'ShareFile', 'Enrollment Profiles', and 'Delivery Groups'. The 'Actions' section is active, and a sidebar on the left shows a list of steps: '1 Action Info', '2 Details', '3 Assignment (optional)', and '4 Summary'. The main content area is titled 'Actions' and contains the following configuration fields:

- A dropdown menu set to 'Device property'.
- A dropdown menu labeled 'Select a device property'.
- An 'Action*' section with a dropdown menu set to 'App wipe'.
- A text input field containing the number '1'.
- A dropdown menu set to 'Hours'.
- A 'Summary' section containing the text: 'If **DEVICE PROPERTY CONDITION IS FULFILLED**, then app wipe the device after 1 hour(s).'.

At the bottom right of the configuration area, there are 'Back' and 'Next >' buttons.

6. Configure deployment rules and then click **Next**.

7. Configure delivery group assignments and a deployment schedule and then click **Next**.

8. Click **Save**.

To check app lock or app wipe status

1. Go to **Manage > Devices**, click a device and then click **Show more**.

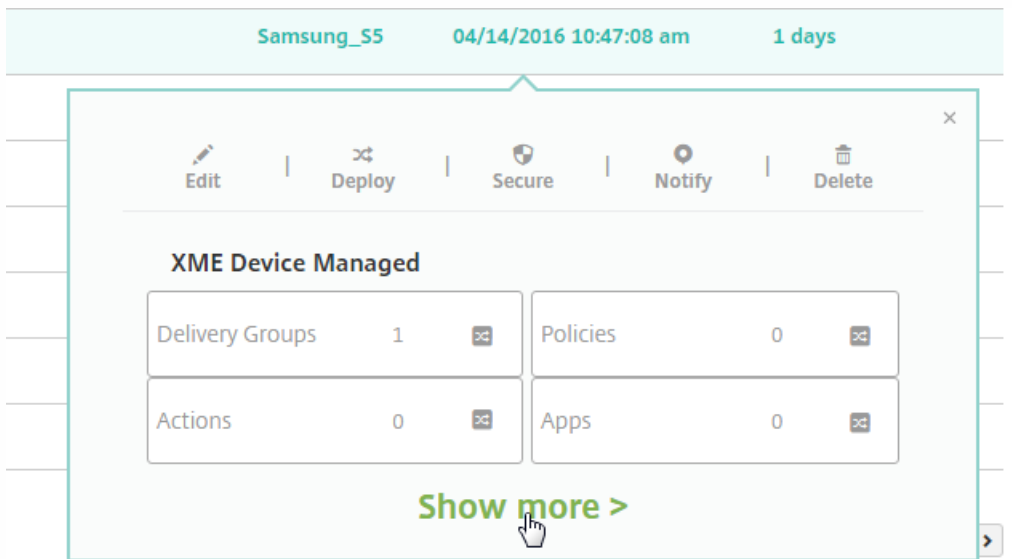

2. Scroll to **Device App Wipe** and **Device App Lock**.

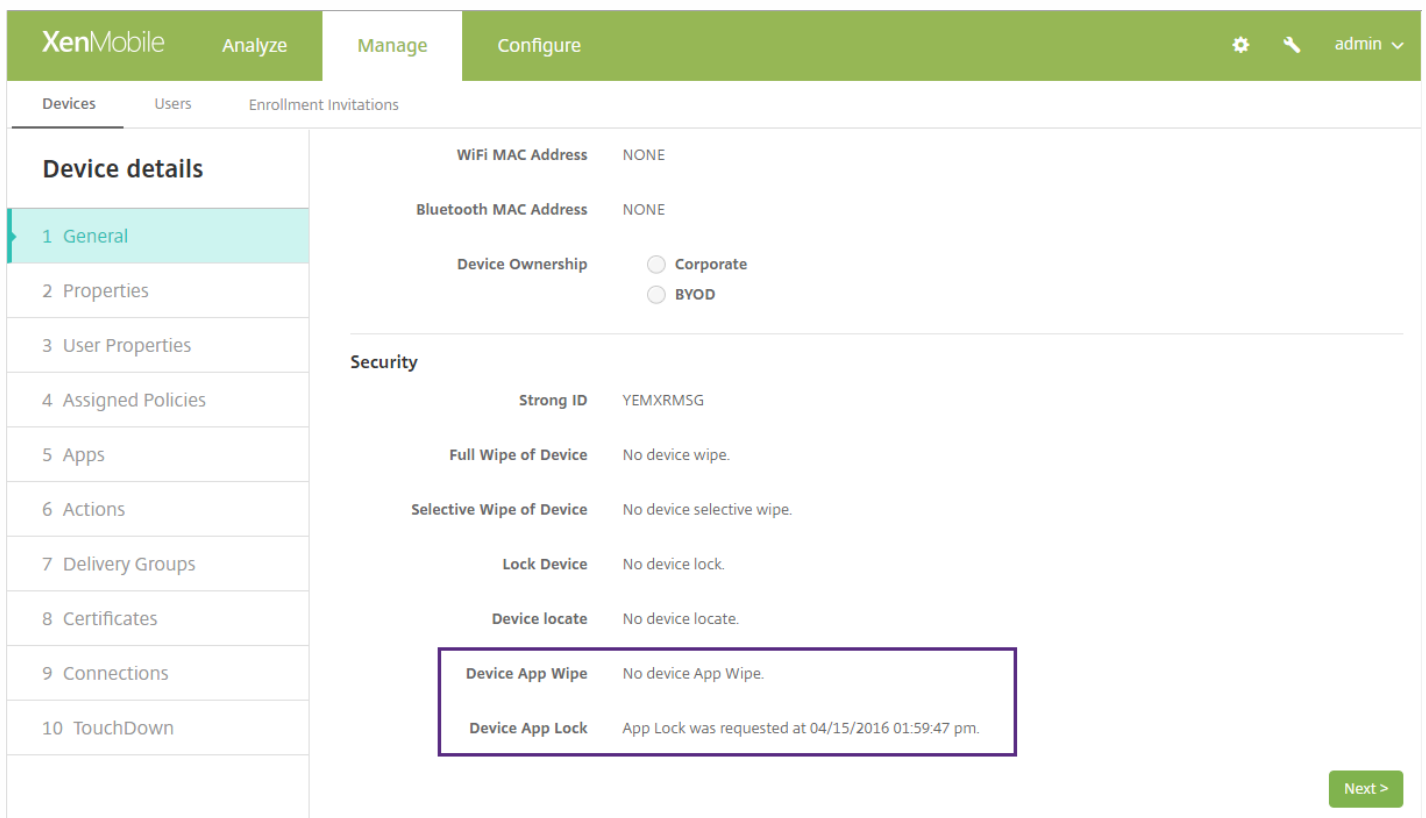

Monitor and support

Jun 19, 2017

You can use the XenMobile Dashboard and the XenMobile Support page to monitor and troubleshoot your XenMobile Server. Use the XenMobile Support page to access several support-related information and tools. You can also carry out actions from the XenMobile CLI. For details, see [Command-line interface options](#).

In the XenMobile console, click the wrench icon in the upper-right corner.



The Support page appears.

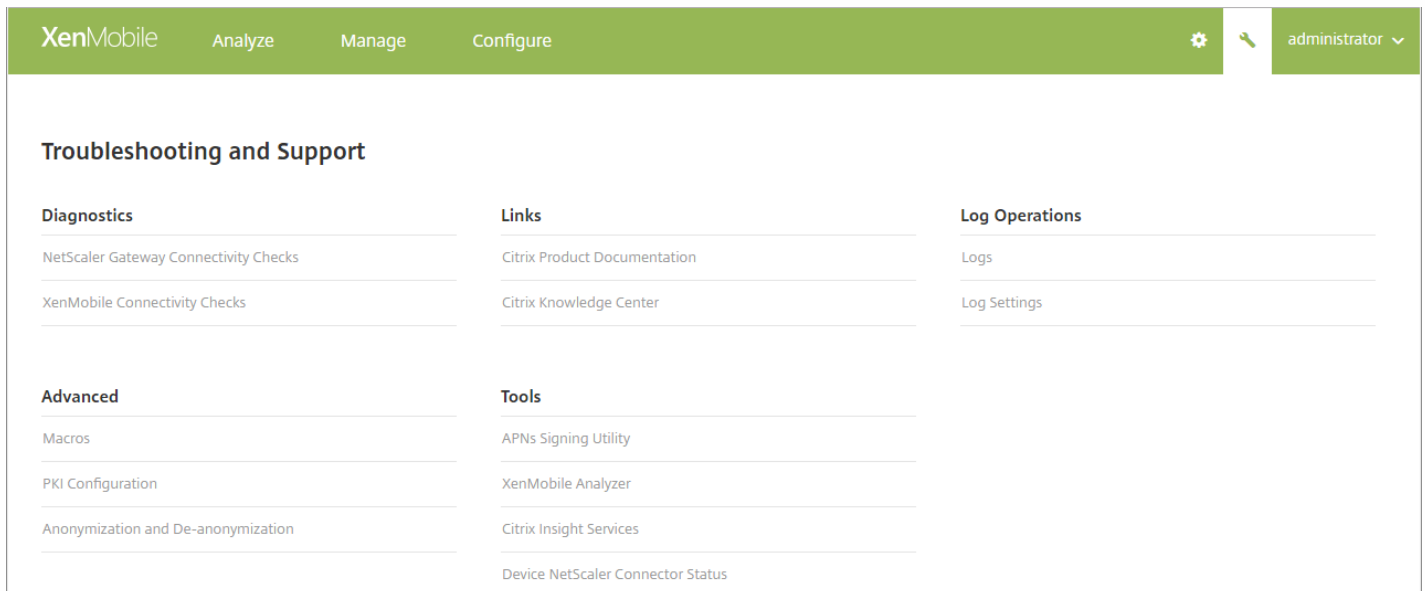

Use the XenMobile **Support** page to:

- Access diagnostics.
- Create support bundles.
- Access links to Citrix Product Documentation and the Knowledge Center.
- Access log operations.
- Select from a set of advanced information and configuration options.
- Access a set of tools and utilities.

You can also view information at a glance by accessing your XenMobile console dashboard. With this information, you can see issues and successes quickly by using widgets.

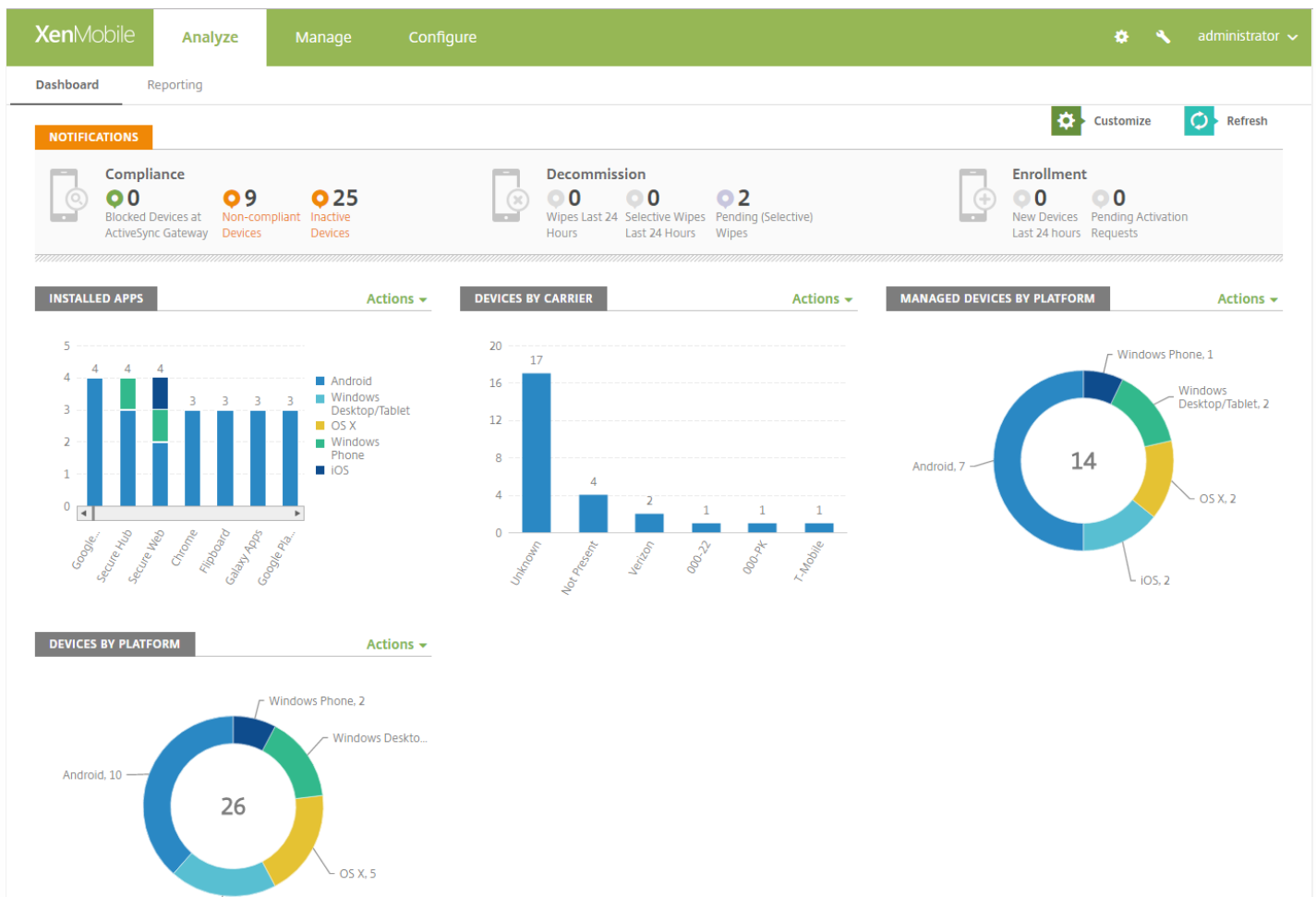

The dashboard is usually the page that first appears when you sign on to the XenMobile console. To access the dashboard from elsewhere in the console, click **Analyze**. Click **Customize** on the dashboard to edit the layout of the page and to edit the widgets that appear.

- **My Dashboards:** You can save up to four dashboards. You can edit these dashboards separately and view each one by selecting the saved dashboard.
- **Layout Style:** In this row, you can select how many widgets appear on your dashboard and how the widgets are laid out.
- **Widget Selection:** You can choose which information appears on your dashboard.
 - **Notifications:** Mark the check box above the numbers on the left to add a Notifications bar above your widgets. This bar shows the number of compliant devices, inactive devices, and devices wiped or enrolled in the last 24 hours.
 - **Devices By Platform:** Displays the number of managed and unmanaged devices by platform.
 - **Devices By Carrier:** Displays the number of managed and unmanaged devices by carrier. Click each bar to see a breakdown by platform.
 - **Managed Devices By Platform:** Displays the number of managed devices by platform.
 - **Unmanaged Devices By Platform:** Displays the number of unmanaged devices by platform. Devices that appear in this chart might have an agent installed on them, but have had their privileges revoked or have been wiped.
 - **Devices By ActiveSync Gateway Status:** Displays the number of devices grouped by ActiveSync Gateway status. The information shows Blocked, Allowed, or Unknown status. You can click each bar to break down the data by platform.
 - **Devices By Ownership:** Displays the number of devices grouped by ownership status. The information shows

corporate-owned, employee-owned, or unknown ownership status.

- **Android TouchDown License Status:** Displays the number of devices that have a TouchDown license.
- **Failed Delivery Group Deployments:** Displays the total number of failed deployments per package. Only packages that have failed deployments appear.
- **Devices By Blocked Reason:** Displays the number of devices blocked by ActiveSync
- **Installed Apps:** Type an app name for a graph of app information.
- **VPP Apps License Usage:** Displays license usage statistics for Apple Volume Purchase Program apps.

With each widget, you can click the individual parts to drill down for more information.

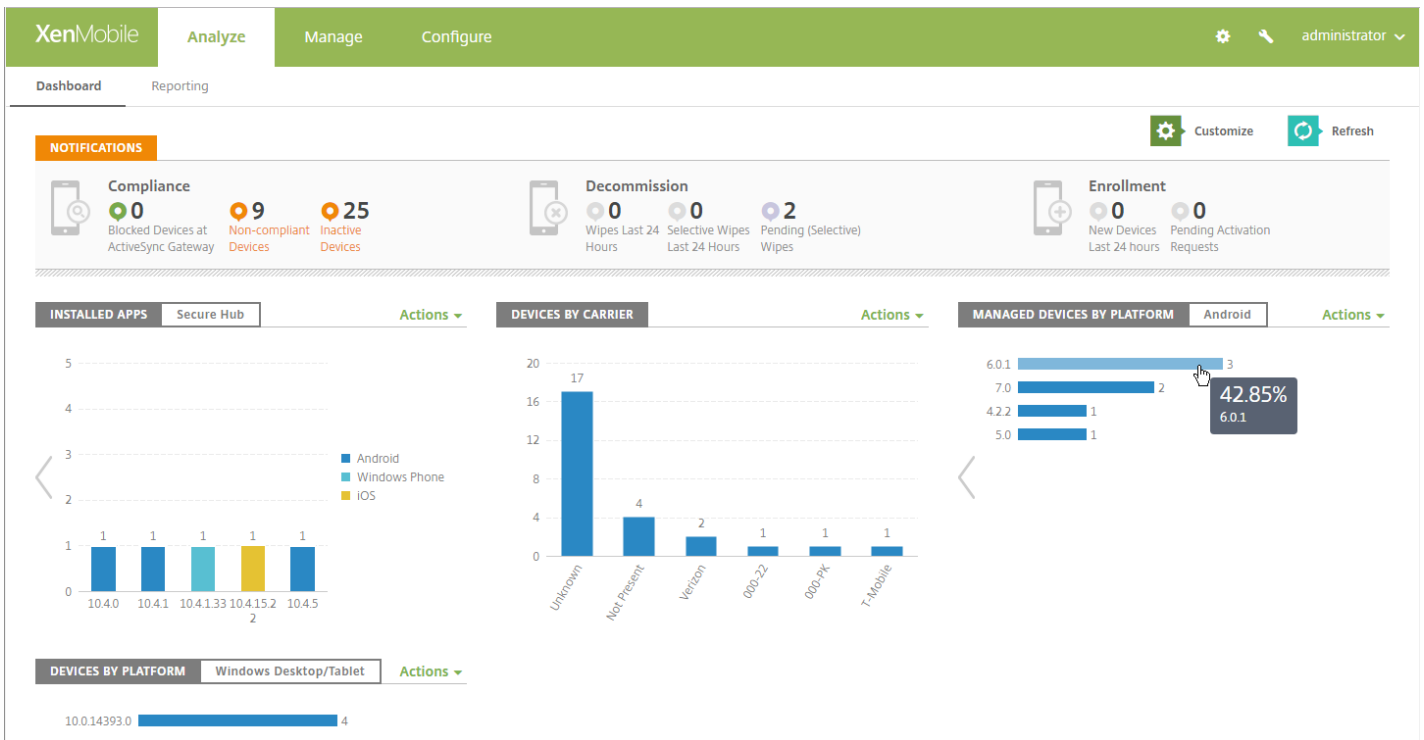

You can also export the information as a .csv file by clicking the **Action** drop-down.

NOTIFICATIONS



Compliance

0

Blocked Devices at
ActiveSync Gateway

9

Non-compliant
Devices

25

Inactive
Devices

INSTALLED APPS

Actions

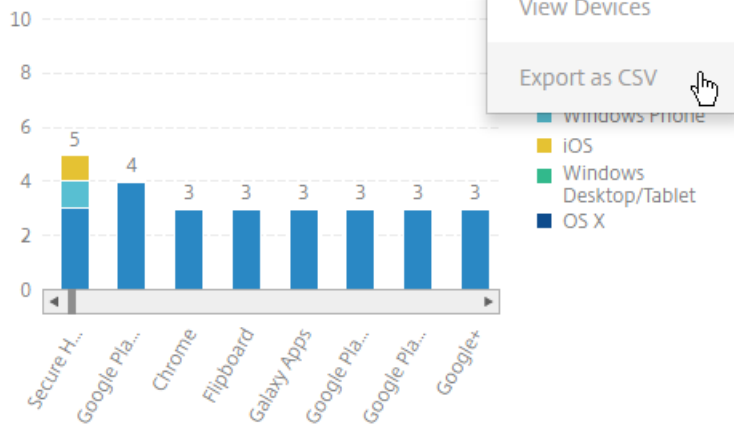

Reports

Jun 19, 2017

XenMobile provides the following pre-defined reports that let you analyze your app and device deployments. Each report appears as a table and a chart. You can sort and filter the tables by column. You can select elements in charts from more detailed information.

- **Total Apps Deployment Attempts:** Lists deployed apps that users tried to install on their devices.
- **Apps by Platform:** Lists apps and app versions by device platform and version.
- **Apps by Type:** Lists apps by version, type, and category.
- **Device Enrollment:** Lists all enrolled devices.
- **Devices & Apps:** Lists devices that are running managed apps.
- **Inactive Devices:** A list of devices that have not had any activity for the number of days specified by the XenMobile Server property `device.inactivity.days.threshold`.
- **Jailbroken/Rooted Devices:** Lists jailbroken iOS devices and rooted Android devices.
- **Terms & Conditions:** Lists users who have accepted and declined Terms and Conditions agreements. You can select areas of the chart to view more details.
- **Top 10 Apps:** Failed Deployment - Lists up to 10 apps that have failed to deploy.
- **Blacklisted Apps by Device & User:** Lists blacklisted apps that users have on their devices.

You can export the data in each table in .csv format, which you can open by using programs like Microsoft Excel. You can export the chart for each report in PDF format.

To generate a report:

1. In the XenMobile console, click **Analyze > Reporting**. The **Reporting** page appears.
2. Click the report you want to generate.

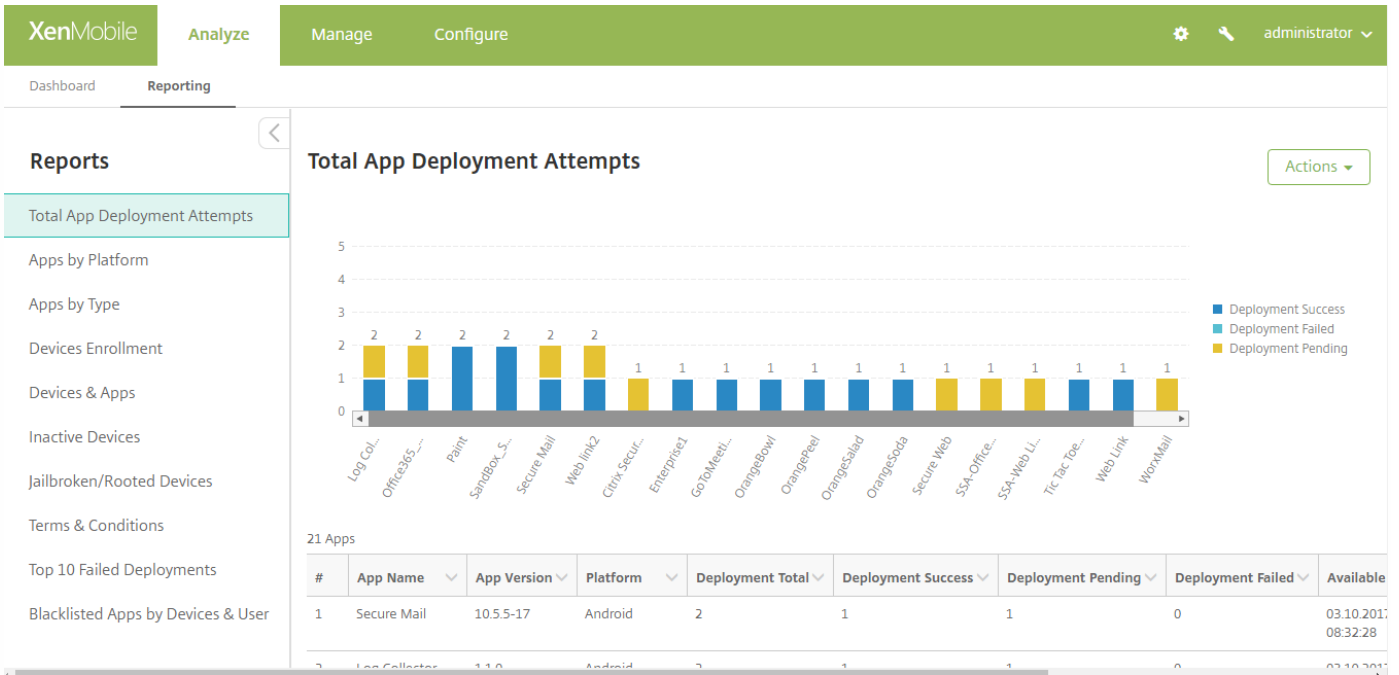

To view more details of a report:

- Click areas of the chart to drill down and see more details information.

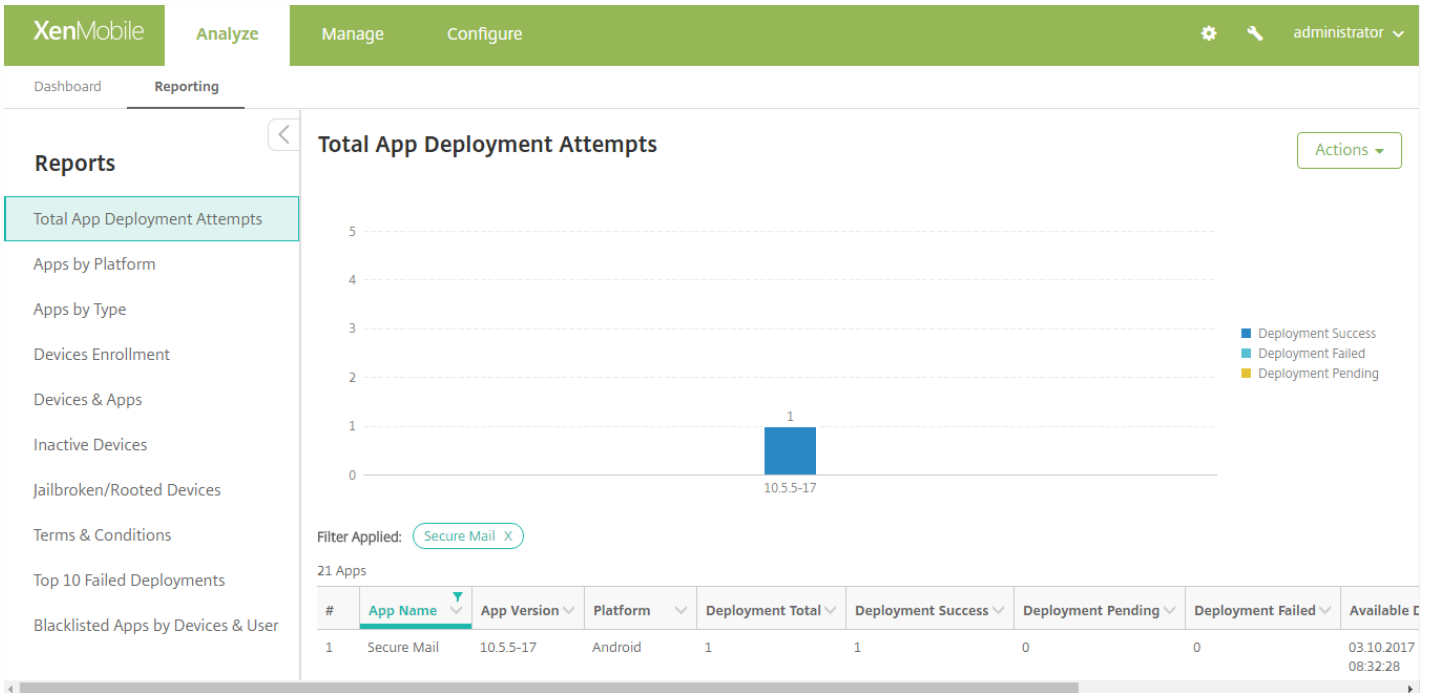

- To sort, filter, or search a table column, click the column heading.

XenMobile Analyze Manage Configure administrator

Dashboard Reporting

Reports

- Total App Deployment Attempts
- Apps by Platform
- Apps by Type
- Devices Enrollment
- Devices & Apps
- Inactive Devices
- Jailbroken/Rooted Devices
- Terms & Conditions
- Top 10 Failed Deployments
- Blacklisted Apps by Devices & User

22 Apps

#	App Name	App Version	Platform	Deployment Total	Deployment Success	Deployment Pending	Deployment Failed	Available
1	Enterprise1			1	1	0	0	03.10.201 09:10:10
2	SandBox_S			1	1	0	0	03.10.201 08:38:40
3	Fonts			1	0	1	0	03.10.201 09:45:07
4	SandBox_S			1	1	0	0	03.10.201 08:38:40
5	GoToMeeti			1	1	0	0	03.10.201 12:34:35
6	Secure Mail	10.5.5-17	Android	1	1	0	0	03.10.201 08:32:28
7	GreedyPenguins		Windows Mobile	1	1	0	0	03.10.201 13:01:50

- To filter the report by date:

Click a column heading to view the filter settings.

XenMobile Analyze Manage Configure administrator

Dashboard Reporting

Reports

- Total App Deployment Attempts
- Apps by Platform
- Apps by Type
- Devices Enrollment
- Devices & Apps
- Inactive Devices
- Jailbroken/Rooted Devices
- Terms & Conditions
- Top 10 Failed Deployments
- Blacklisted Apps by Devices & User

Status	Last authentication	Last access	Enrollment state	Enrollment date	Device ownership	Location	Deployment status	App name
Compliance	03.27.2017 09:29:08			03.27.2017 07:33:27	Unknown		SUCCESS	Globoforce_SA
Compliance	03.27.2017 09:29:08			03.27.2017 07:33:27	Unknown		SUCCESS	Jota Text Editor
Compliance	03.27.2017 09:29:08			03.27.2017 07:33:27	Unknown		SUCCESS	Tic Tac Toe Fre
Compliance	03.27.2017 09:29:08	03.27.2017 09:44:07	Enrolled	03.27.2017 07:33:27	Unknown		SUCCESS	Web Link
Compliance	03.27.2017 09:55:27	03.27.2017 09:55:27	Enrolled	09.27.2016 04:48:39	Unknown		SUCCESS	Globoforce_SA

From **Filter Condition**, choose how you want to restrict the dates reported.

XenMobile Analyze Manage Configure administrator

Dashboard Reporting

Reports

- Total App Deployment Attempts
- Apps by Platform
- Apps by Type
- Devices Enrollment
- Devices & Apps**
- Inactive Devices
- Jailbroken/Rooted Devices
- Terms & Conditions
- Top 10 Failed Deployments
- Blacklisted Apps by Devices & User

Status	Last authentication	Last access	Enrollment state	Enrollment date	Device ownership	Location	Deployment status	App name
Compliance	03.27.2017 09:29:08	↑ Sort Ascending ↓ Sort Descending		03.27.2017 07:33:27	Unknown		SUCCESS	Globoforce_SA
Compliance	03.27.2017 09:29:08	Filter Condition is on		03.27.2017 07:33:27	Unknown		SUCCESS	Jota Text Editor
Compliance	03.27.2017 09:29:08			03.27.2017 07:33:27	Unknown		SUCCESS	Tic Tac Toe Fre
Compliance	03.27.2017 09:29:08	03.27.2017 09:44:07	Enrolled	03.27.2017 07:33:27	Unknown		SUCCESS	Web Link
Compliance	03.27.2017 09:55:27	03.27.2017 09:55:27	Enrolled	09.27.2016 04:48:39	Unknown		SUCCESS	Globoforce_SA

Use the date chooser to specify dates.

XenMobile Analyze Manage Configure administrator

Dashboard Reporting

Reports

- Total App Deployment Attempts
- Apps by Platform
- Apps by Type
- Devices Enrollment
- Devices & Apps**
- Inactive Devices
- Jailbroken/Rooted Devices
- Terms & Conditions
- Top 10 Failed Deployments
- Blacklisted Apps by Devices & User

Status	Last authentication	Last access	Enrollment state	Enrollment date	Device ownership	Location	Deployment status	App name
Compliance	03.27.2017 09:29:08	↑ Sort Ascending ↓ Sort Descending		03.27.2017 07:33:27	Unknown		SUCCESS	Globoforce_SA
Compliance	03.27.2017 09:29:08	Filter Condition is on or before		03.27.2017 07:33:27	Unknown		SUCCESS	Jota Text Editor
Compliance	03.27.2017 09:29:08	Value *		03.27.2017 07:33:27	Unknown		SUCCESS	Tic Tac Toe Fre
Compliance	03.27.2017 09:29:08	MM/DD/YYYY		03.27.2017 07:33:27	Unknown		SUCCESS	Web Link
Compliance	03.27.2017 09:55:27	April 2017		09.27.2016 04:48:39	Unknown		SUCCESS	Globoforce_SA
Compliance	03.27.2017 09:55:27	Calendar grid		09.27.2016 04:48:39	Unknown		SUCCESS	Jota Text Editor

A column with a date filter displays as shown the following example.

	Status	Last authentication	Last access	Enrollment state	Enrollment date	Device ownership	Location	Deployment status	App name
Compliance		03.27.2017 09:29:08	03.27.2017 09:44:07	Enrolled	03.27.2017 07:33:27	Unknown		SUCCESS	Globoforce_S
Compliance		03.27.2017 09:29:08	03.27.2017 09:44:07	Enrolled	03.27.2017 07:33:27	Unknown		SUCCESS	Jota Text Edito

To remove a filter, click the column heading and then click **Remove Filter**.

	Status	Last authentication	Last access	Enrollment state	Enrollment date	Device ownership	Location	Deployment status	App name
Compliance		03.27.2017 09:29:08			03.27.2017 07:33:27	Unknown		SUCCESS	Globoforce_S
Compliance		03.27.2017 09:29:08			03.27.2017 07:33:27	Unknown		SUCCESS	Jota Text Edito
Compliance		03.27.2017 09:29:08			03.27.2017 07:33:27	Unknown		SUCCESS	Tic Tac Toe Fre
Compliance		03.27.2017 09:29:08			03.27.2017 07:33:27	Unknown		SUCCESS	Web Link

To export a chart or table:

- To export the chart in PDF format, click **Action > Export graph as PDF**.
- To export the table data in CSV format, click **Action > Export data as CVS**.

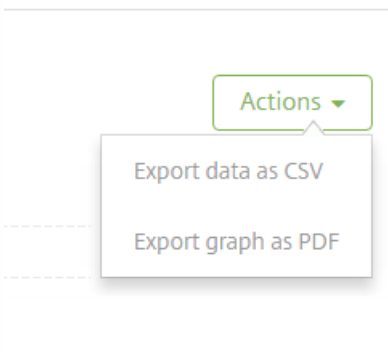

Important

Although it is possible to use SQL Server to create custom reports, Citrix does not recommend this method. Using the SQL Server database in this manner might have unforeseen consequences on your XenMobile deployment. If you do decide to pursue this method of reporting, ensure that SQL queries are run using a read-only account.

Mobile Service Provider

Jun 19, 2017

You can enable XenMobile to use the Mobile Service Provider interface to query BlackBerry and Exchange ActiveSync devices and issue operations.

For example, your organization may have 1,000 users and each user may use one or more devices. After you communicate to every user that he or she must enroll their devices with XenMobile for management, the XenMobile console indicates the number of devices that users enroll. By configuring this setting, you can determine how many devices connect to Exchange Server. In this way, you can do the following:

- Determine if any users still need to enroll their devices.
- Issue commands to user devices that connect to Exchange Server, such as data wipes.

1. In the XenMobile console, click the gear icon in the upper-right corner. The **Settings** page appears.
2. Under **Server**, click **Mobile Service Provider**. The **Mobile Service Provider** page appears.

The screenshot shows the XenMobile console interface. At the top, there is a navigation bar with 'XenMobile' and tabs for 'Analyze', 'Manage', and 'Configure'. On the right, there is a gear icon and a user profile 'admin'. Below the navigation bar, the breadcrumb 'Settings > Mobile Service Provider' is visible. The main heading is 'Mobile Service Provider' with a sub-heading: 'Allows XenMobile to use the Mobile Service Provider interface to query BlackBerry and other Exchange ActiveSync devices and issue operations.' The form contains three input fields: 'Web service URL*' with the value 'http://XmmServer/services/zdm', 'User name*' with the value 'domain\admin', and 'Password*'. Below these is a toggle switch for 'Automatically update BlackBerry and ActiveSync device connections' which is currently set to 'OFF'. A green 'Test Connection' button is located below the toggle. At the bottom right, there are 'Cancel' and 'Save' buttons.

3. Configure these settings:

- **Web service URL:** Type the URL of the Web service; for example, `http://XmmServer/services/xdmservice`
- **User name:** Type the user name in the format `domain\admin`.
- **Password:** Type the password.
- **Automatically update BlackBerry and ActiveSync device connections:** Select whether to automatically update device connections. The default is **OFF**
- Click **Test Connection** to verify connectivity.

4. Click **Save**.

SysLog

Jun 19, 2017

You can configure XenMobile Server (on-premises only) to send log files to a systems log (syslog) server. You need the server host name or IP address.

Syslog is a standard logging protocol with two components: an auditing module (which runs on the appliance) and a server, which can run on a remote system. The Syslog protocol uses the user data protocol (UDP) for data transfer. Admin events and User events are recorded.

You can configure the server to collect the following types of information:

- System logs that contain a record of actions taken by XenMobile.
- Audit logs that contain a chronological record of system activities for XenMobile.

The log information that a syslog server collects from an appliance is stored in a log file in the form of messages. These messages typically contain the following information:

- The IP address of the appliance that generated the log message
- A time stamp
- The message type
- The log level associated with an event (Critical, Error, Notice, Warning, Informational, Debug, Alert, or Emergency)
- The message information

You can use this information to analyze the source of the alert and take corrective action if necessary.

Note

In XenMobile Service (cloud) deployments, Citrix does not support syslog integration with an on-premises syslog server. Instead, you can download the logs from the Support page in the XenMobile console. When doing so, you must click **Download All** to get system logs. For details, see [View and analyze log files in XenMobile](#).

1. In the XenMobile console, click the gear icon in the upper-right corner. The **Settings** page appears.
2. Click **Syslog**. The **Syslog** page appears.

XenMobile Analyze Manage Configure

Settings > SysLog

SysLog

You can configure XenMobile to send log files to a systems log (syslog) server using the server host name or IP address.

Server*

Port*

Information to log

System Logs ?

Audit ?

Cancel Save

3. Configure these settings:

- **Server:** Type either the IP address or the fully qualified domain name (FQDN) of your syslog server.
- **Port:** Type the port number. By default, the port is set to 514.
- **Information to log:** Select or clear **System Logs** and **Audit**.
 - System logs contain actions taken by XenMobile.
 - Audit logs contain a chronological record of system activities for XenMobile.

4. Click **Save**.

Customer Experience Improvement Program

Jun 19, 2017

The Citrix Customer Experience Improvement Program (CEIP) gathers anonymous configuration and usage data from XenMobile and automatically sends the data to Citrix. This data helps Citrix improve the quality, reliability, and performance of XenMobile. Participation in the CEIP is completely voluntary. When you first install XenMobile, or when you install an update, you have the option to participate in the CEIP. When you opt-in, data is typically collected on a weekly basis, and performance and usage data is collected hourly. The data is stored on disk and transferred securely via HTTPS to Citrix weekly. You can change whether you participate in the CEIP in the XenMobile console. For more information on the CEIP, see [About the Citrix Customer Experience Improvement Program \(CEIP\)](#).

Choosing to participate in the CEIP

The first time you install XenMobile or when you do an update, you see the following dialog box that prompts you to participate.

Customer Experience Improvement Program

Help improve the quality and performance of Citrix products by sending anonymous statistics and usage information.

How does it work?

- No information that identifies individuals is collected
- Collects only configuration, performance, and reliability data
- Data is stored on disk until it is transferred to Citrix
- Secure weekly transfers via HTTPS to Citrix servers
- Data is immediately deleted from disk after successful transfer

[Learn more](#)



Would you like to help make Citrix products better by joining the program?
(You can go to Configure -> Settings -> More -> Experience Improvement Program to change your answer at any time.)

Yes, send anonymous usage and statistics information.

No

Changing your CEIP participation setting

1. To change your CEIP participation setting, in the XenMobile console, click the gear icon in the upper-right corner of the console to open the **Settings** page.

2. Under **Server**, click **Experience Improvement Program**. The **Customer Experience Improvement Program** page appears. The exact page you see depends on whether you are currently participating in the CEIP.

Settings > [Experience Improvement Program](#)

Customer Experience Improvement Program

Help improve the quality and performance of Citrix products by sending anonymous statistics and usage information.

How does it work?

- No information that identifies individuals is collected
- Collects only configuration, performance, and reliability data
- Data is stored on disk until it is transferred to Citrix
- Secure weekly transfers via HTTPS to Citrix servers
- Data is immediately deleted from disk after successful transfer



[Learn more](#)

You are currently participating in the Customer Experience Improvement Program.

- Continue participating
- Stop participating

Cancel

Save

3. If you are currently participating in the CEIP and want to stop, click **Stop participating**.

4. If you are not currently participating in the CEIP and want to start, click **Start participating**.

5. Click **Save**.

Support options and Remote Support

Jun 19, 2017

You can provide an email address for users to contact support staff. When users request assistance from their devices, they see the email address.

You can also configure how users send logs to the help desk from their devices. You can configure the logs to be sent directly or by email.

1. In the XenMobile console, click the gear icon in the upper-right corner. The **Settings** page appears.

The screenshot shows the XenMobile console interface. The top navigation bar is green and contains the XenMobile logo and tabs for Dashboard, Manage, and Configure. On the right side of the header, there is a gear icon for settings and an 'Admin' dropdown menu. The main content area is titled 'Settings' and is organized into three columns of settings categories. The first column includes 'Certificate Management' (Certificates, Credential Providers, PKI Entities) and 'Client' (Client Branding, Client Properties, Client Support). The second column includes 'Notifications' (Carrier SMS Gateway, Notification Server, Notification Templates) and 'Platforms' (Android for Work, Google Play Credentials, iOS Bulk Enrollment, iOS Settings, Samsung KNOX). The third column includes 'Server' (ActiveSync Gateway, Enrollment, LDAP, Licensing, Local Users and Groups, Mobile Service Provider, NetScaler Gateway, Network Access Control, Release Management, Role-Based Access Control, Server Properties, SysLog, Workflows, XenApp/XenDesktop). On the right side of the settings area, there is a 'Frequently Accessed' sidebar with links to Certificates, Enrollment, Licensing, Local Users and Groups, Role-Based Access Control, and Release Management.

2. Under **Client**, click **Client Support**. The **Client Support** page appears.

3. Configure the following settings:

- **Support email (IT help desk):** Type the email address for your IT help desk contact.
- **Send device logs to IT help desk:** Select whether device logs are sent **directly** or **by email**. The default is **by email**.
 - When you enable **directly**, settings for Store logs on ShareFile appear. If you enable Store logs on ShareFile, logs are sent directly to ShareFile. Otherwise, the logs are sent to XenMobile and then emailed to the help desk. In addition, the **If sending directly fails, use email** option appears, which is enabled by default. You can disable this option when you do not want to use the client email to send the logs for a server problem. When, however, you disable this option and a server problem occurs, the logs are not sent.
 - When you enable **by email**, the client email is always used to send the logs.

4. Click **Save**.

Remote Support

Remote support enables your help desk representatives to take remote control of managed Windows and Android mobile devices.

Remote Support is available on all Windows mobile devices and on Android Samsung SAFE devices and non-Samsung devices. The Remote Support client is not available in XenMobile Service versions 10.x for Windows CE and Samsung Android devices.

Screen cast is supported on Samsung KNOX devices only.

Remote control of iOS devices is not supported.

During a remote control session:

- Users see on their mobile device an icon indicating a remote control session is active.
- Remote Support users see the Remote Support application window and a Remote Control window that shows a rendering of the controlled device.

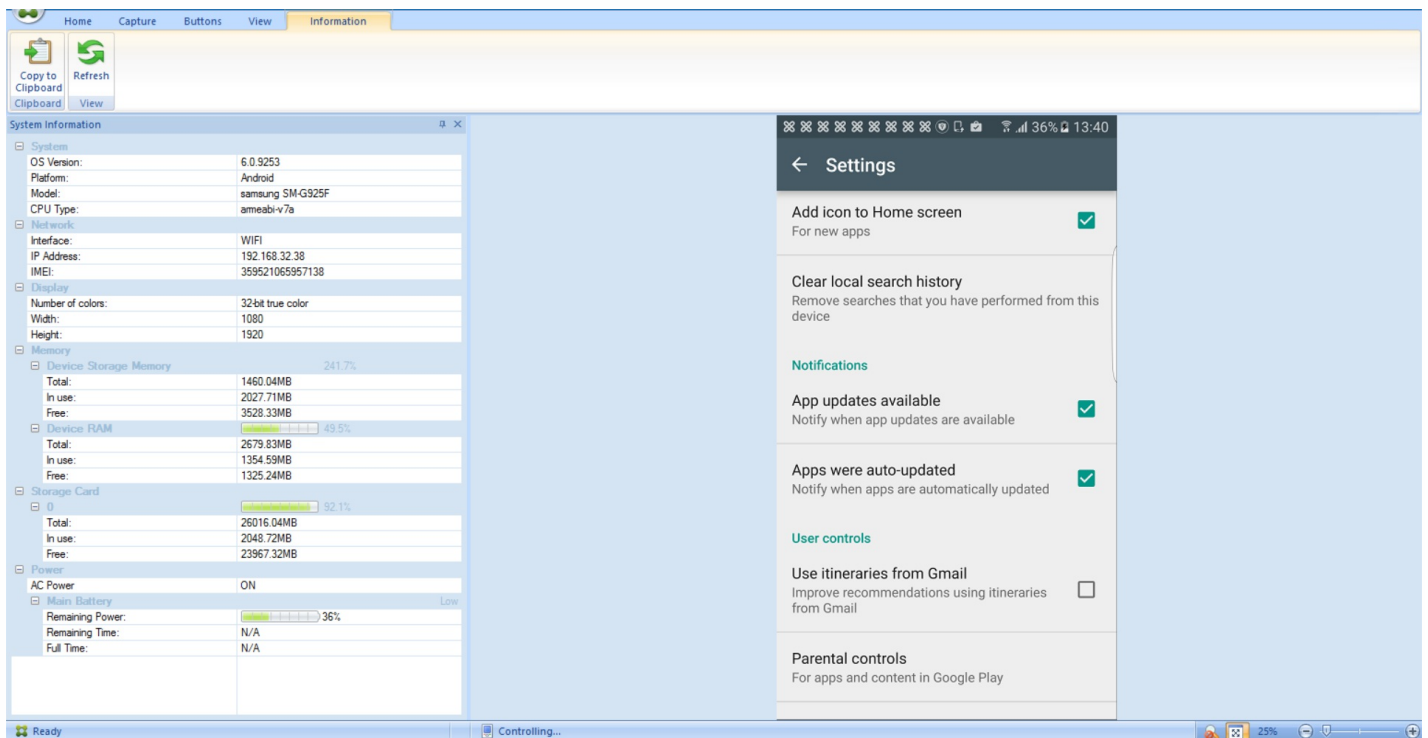

By using Remote Support, you can do the following:

- Remotely sign on to a user device and control the screen. Users can watch you navigate their screen, which can also be helpful for training purposes.
- Navigate and repair a remote device in real time. You can change configurations, troubleshoot operating system issues, and disable or stop problematic apps or processes.
- Isolate and contain threats before they spread to other mobile devices by remotely disabling network access, stopping rogue processes, and removing apps or malware.

- Remotely enable the device ringer and call the phone, to help the user to locate the device. When a user can't find the device, you can wipe it to ensure that your sensitive data is not compromised.

Remote Support also enables support personnel to:

- Display a list of all connected devices within one or more instances of XenMobile.
- Display system information including device model, operating system level, International Mobile Station Equipment Identity (IMEI), serial number, memory and battery status, and connectivity.
- Display the users and groups for XenMobile.
- Run the device task manager where you can display active processes, end active processes, and restart the mobile device.
- Run remote file transfer that includes bidirectional file transfer between mobile devices and a central file server.
- Download and install software programs as a batch to one or more mobile devices.
- Configure remote registry key settings on the device.
- Optimize response time over low-bandwidth cellular networks by using real-time device screen remote control.
- Display the device skin for most mobile device brands and models. Display a skin editor to add new device models and map physical keys.
- Enable device screen capture, record, and replay with the ability to capture a sequence of interactions on the device that creates a video AVI file.
- Conduct live meetings by using a shared whiteboard, VoIP-based voice communications and chat among mobile users and support personnel.

Remote Support System Requirements

The Remote Support software installs on Windows-based computers which meet the following requirements. For port requirements, see [Port Requirements](#).

Supported platforms:

- Intel Xeon/Pentium 4 -1 GHz minimum Workstation class
- 512-MB RAM minimum
- 100-MB free disk space minimum

Supported operating systems:

- Microsoft Windows 2003 Server Standard Edition or Enterprise Edition SP1 or later
- Microsoft Windows 2000 Professional SP4
- Microsoft Windows XP SP2 or later
- Microsoft Windows Vista SP1 or later
- Microsoft Windows 10
- Microsoft Windows 8
- Microsoft Windows 7

To install the Remote Support software

1. To download the Remote Support installer, go to the [XenMobile 10 download page](#) and log on to your account.
2. Expand **Tools** and then download XenMobile Remote Support v9.
The Remote Support file name is XenMobileRemoteSupport-9.0.0.35265.exe.
3. Double-click the Remote Support installer and then follow the instructions in the installation wizard.

To install Remote Support from the command line:

Run the following command:

```
RemoteSupport.exe /S
```

RemoteSupport is the name of the installation program. For example:

```
XenMobileRemoteSupport-9.0.0.35265.exe /S
```

You can use the following variables when installing the Remote Support software:

- /S: to install the Remote Support software silently with the default parameters.
- /D=dir: to specify a custom installation directory.

To connect Remote Support to XenMobile

To establish remote support connections to managed devices, you must add a connection from Remote Support to one or more XenMobile Servers that manage the devices. That connection runs over an app tunnel that you define in the Tunnel MDM policy, a device policy for Android and Windows Mobile/CE devices. Define the app tunnel before you can connect Remote Support to XenMobile. For details, see [App tunneling device policies](#).

1. Start the Remote Support software and use your XenMobile credentials to sign on.
2. In **Connection Manager**, click **New**.

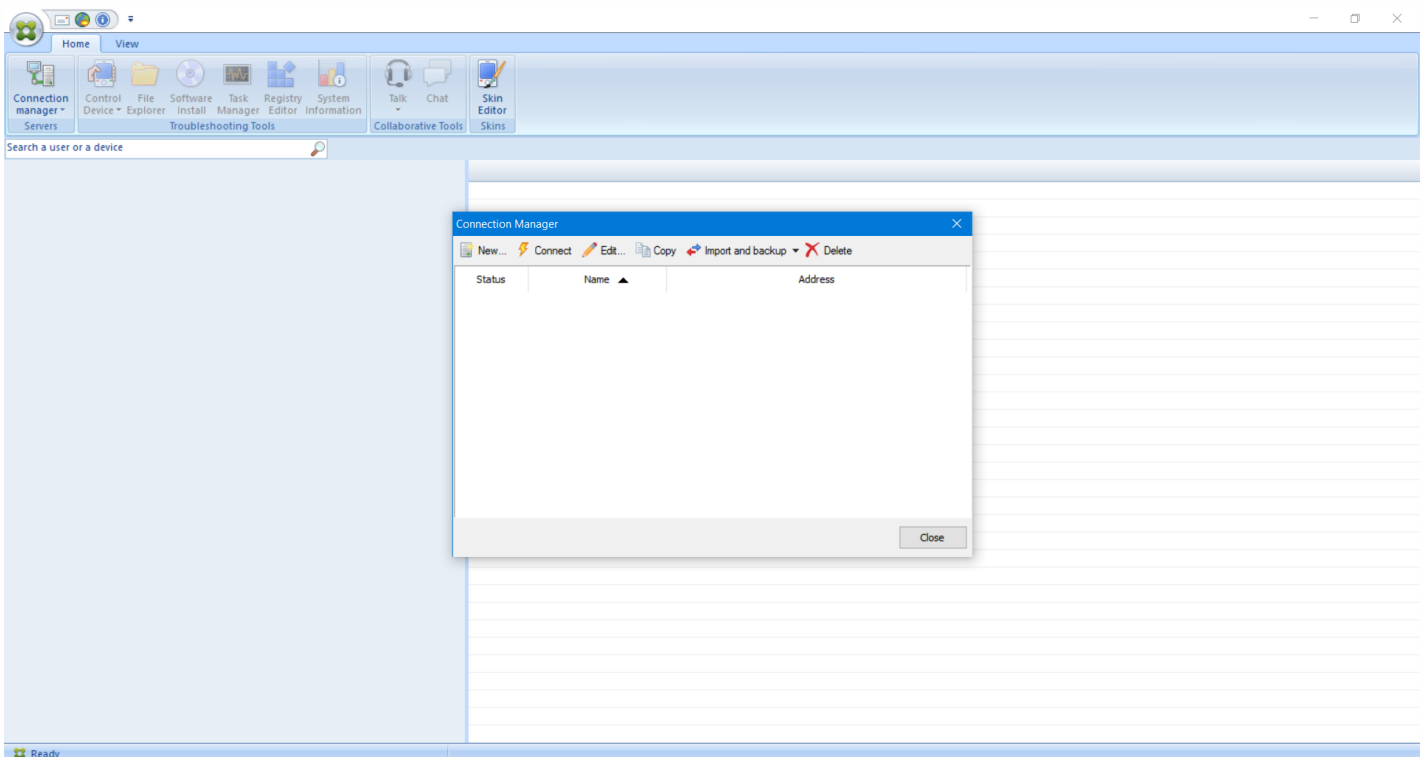

3. In the **Connection Configuration** dialog box, on the **Server** tab, type the following values:
 - a. In **Configuration name**, type a name for the configuration entry.

- b. In **Server IP address or name**, type the IP address or the DNS name of the XenMobile Server.
- c. In **Port**, type a TCP port number, as defined in the XenMobile Server configuration.
- d. In **Instance name**, when XenMobile is part of a multitenant deployment, type an instance name.
- e. In **Tunnel**, type the name of the Tunnel policy.
- f. Select the **Connect to server using SSL Connection** check box.
- g. Select the **Auto reconnect to this server** check box to connect to the configured XenMobile Server each time the Remote Support application starts.

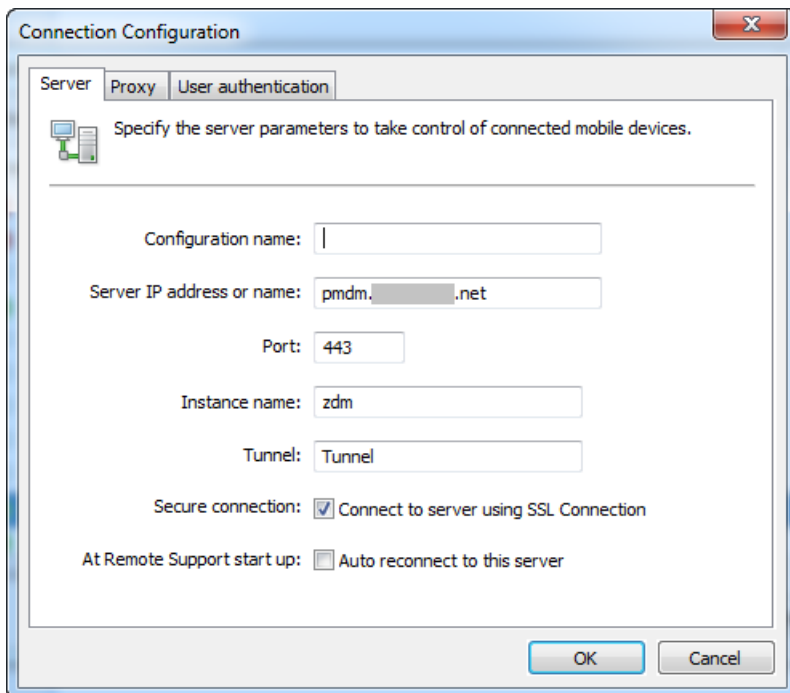

4. On the **Proxy** tab, select **Use a http proxy server** and then type the following information:
 - a. In **Proxy IP Address**, type the IP address of the proxy server.
 - b. In **Port**, type a TCP port number used by the proxy.
 - c. Select the **My proxy server requires authentication** check box when the proxy server requires authentication to allow traffic.
 - d. In **Username**, type the user name to be authenticated on the proxy server.
 - e. In **Password**, type the password to be authenticated on the proxy server.

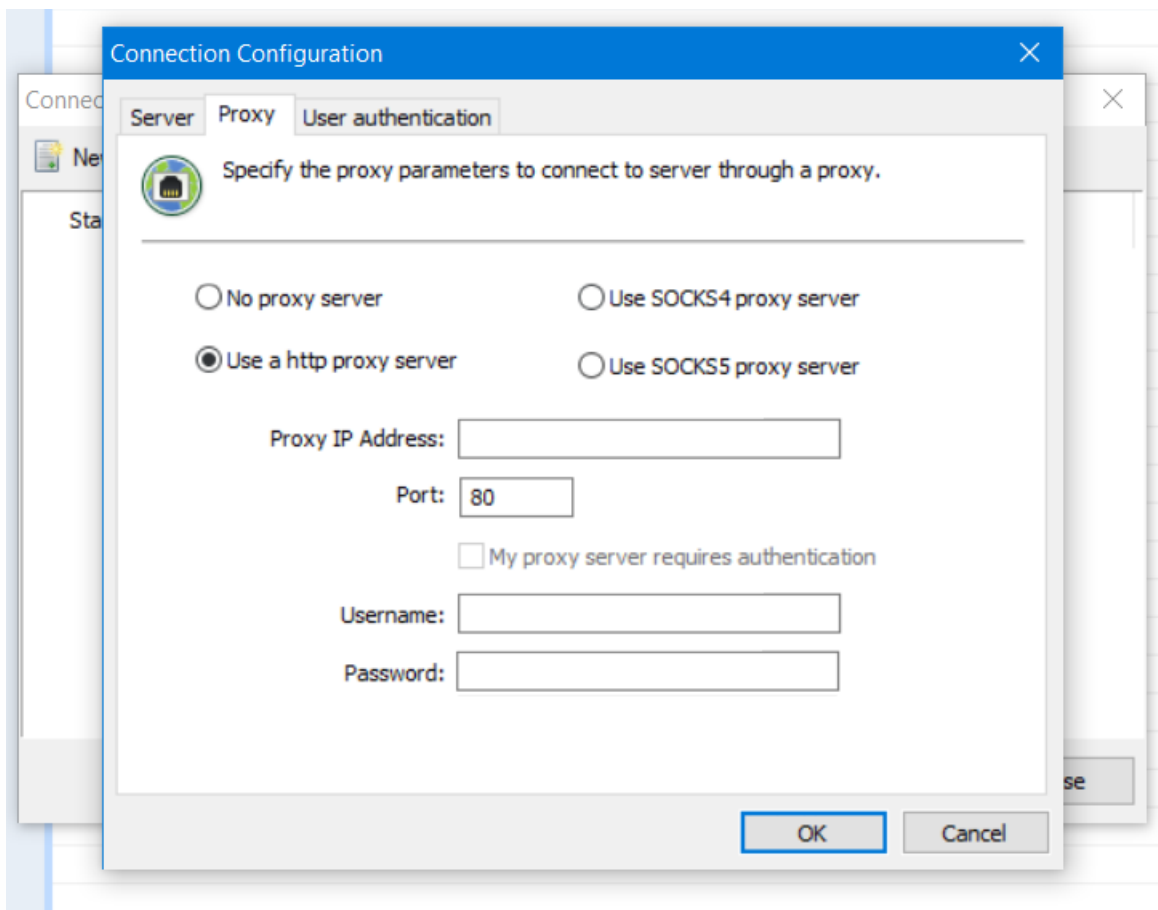

5. On the **User Authentication** tab, select the **Remember my login and password** check box and enter the credentials.
6. Click **OK**.

To connect to XenMobile, double-click the connection you created and then enter the user name and password you configured for the connection.

To enable remote support for Samsung KNOX devices

You create a Remote Support policy in XenMobile to give you remote access to Samsung KNOX devices. You can configure two types of support:

- **Basic:** Lets you view diagnostic information about the device. For example, system information, processes that are running, task manager (memory and CPU usage), and installed software folder contents.
- **Premium:** Lets you remotely control the device screen. For example, control window colors, establish a VoIP session between the help desk and user, and establish a chat session between the help desk and user.

Premium support requires that you configure the Samsung MDM License Key device policy in the XenMobile console. When you configure this policy, select the **Samsung KNOX** platform only. For the Samsung SAFE platform, the ELM key automatically deploys on Samsung devices when they enroll in XenMobile. Therefore, don't select the Samsung SAFE platform for this policy. For details, see [Samsung MDM license key](#).

For information about configuring the Remote Support Policy, see [Remote support device policy](#).

To use a Remote Support session

After you start Remote Support, the left-side of the Remote Support application window presents XenMobile user groups as you defined in the XenMobile console. By default, only groups containing users who are currently connected appear. You can see the device for each user next to the user entry.

1. To see all users, expand each group from the left column.
Those users currently connected to the XenMobile Server are indicated with a green icon.
2. To display all users, including those not currently connected, click **View** and select **Non-connected devices**.
Non-connected users appear without the small green icon.

Devices connected to the XenMobile Server but not assigned to a user appear in Anonymous mode. (The string **Anonymous** appears in the list.) You can control these devices just like the device of a logged-in user.

To control a device, select the device by clicking its row and then clicking **Control Device**. A rendering of the device appears in the Remote Control window. You can interact with a controlled device in the following ways:

- Control the device screen, including control with colors, in either the main window, or in a separate, floating window.
- Establish a VoIP session between the help desk and the user. Configure VoIP settings.
- Establish a chat session with the user.
- Access the device task manager, to manage items such as memory usage, CPU usage, and running apps.
- Explore the mobile device local directories. Transfer files.
- Edit the device registry on Windows mobile devices.
- Display device system information and all installed software.
- Update the mobile device connection status with the XenMobile Server.

Connectivity checks

Jun 19, 2017

From the XenMobile **Support** page, you can check the XenMobile connection to NetScaler Gateway and to other servers and locations.

Conducting XenMobile Connectivity Checks

1. In the XenMobile console, click the wrench icon in the upper-right corner of the console. The **Support** page appears.
2. Under **Diagnostics**, click **XenMobile Connectivity Checks**. The **XenMobile Connectivity Checks** page appears. If your XenMobile environment contains clustered nodes, all nodes are shown.

<input type="checkbox"/>	Connectivity to	IP address or FQDN
<input type="checkbox"/>	Windows Phone Store	windowsphone.com
<input type="checkbox"/>	Databasenet
<input type="checkbox"/>	Apple Feedback Push Notification Server	feedback.push.apple.com
<input type="checkbox"/>	LDAPnet
<input type="checkbox"/>	Domain Name System (DNS)
<input type="checkbox"/>	Nexmo Gateway	-
<input type="checkbox"/>	Apple Push Notification Server	gateway.push.apple.com
<input type="checkbox"/>	iTunes Store/Volume Purchase Program (VPP)	ax.itunes.apple.com
<input type="checkbox"/>	Google Play	play.google.com
<input type="checkbox"/>	Windows Security Token Service	login.live.com

2. Select the servers you want to include in the connectivity test and then click **Test Connectivity**. The test results page appears.

<input type="checkbox"/>	Connectivity to	IP address or FQDN	Status
<input type="checkbox"/>	Databasenet	✓
<input type="checkbox"/>	Windows Phone Store	windowsphone.com	✓

Showing 1 - 2 of 2 items

Clear Results Test Connectivity

3. Select a server in the test results table to see detailed results for that server.

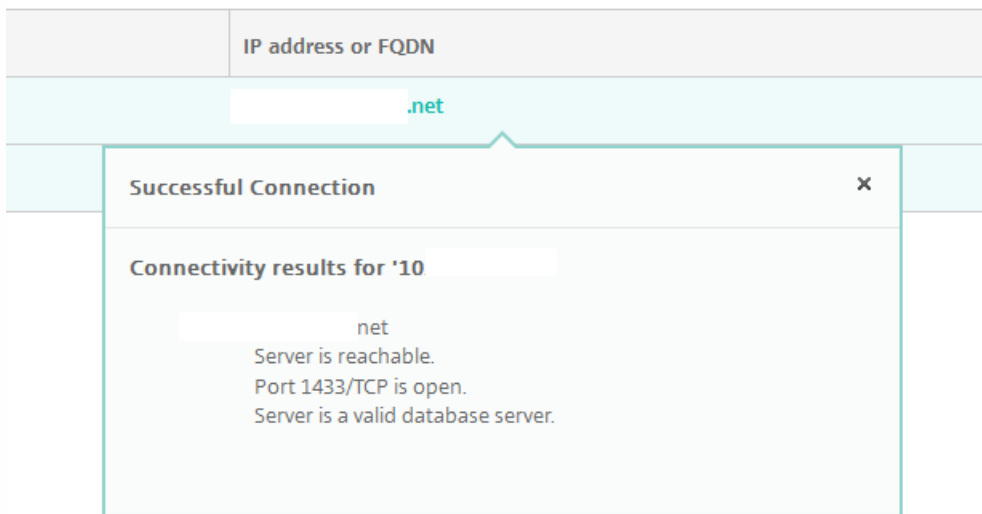

Conducting NetScaler Gateway Connectivity Checks

1. On the **Support** page, under **Diagnostics**, click **NetScaler Gateway Connectivity Checks**. The **NetScaler Gateway Connectivity Checks** page appears. The table is empty if you haven't added any NetScaler Gateway servers.

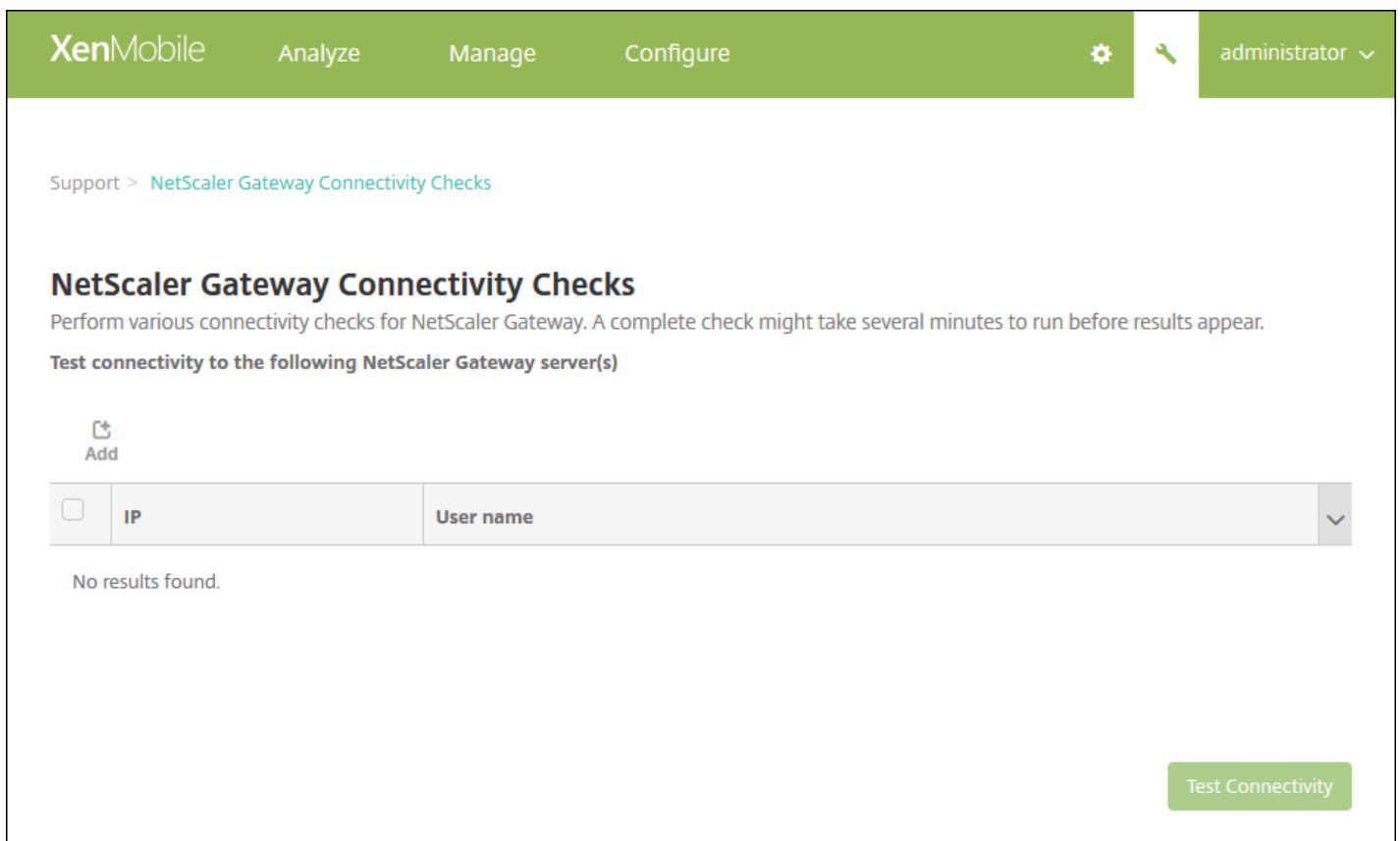

2. Click **Add**. The **Add NetScaler Gateway Server** dialog box appears.

Add NetScaler Gateway Server

NetScaler Gateway Management IP*

User name*

Password*

Cancel Add

3. In **NetScaler Gateway Management IP**, type the management IP address for the server running NetScaler Gateway that you want to test.

Note: If you're conducting a connectivity check for a NetScaler Gateway server that has already been added before, the IP address is provided.

4. Type your administrator credentials for this NetScaler Gateway.

Note: If you're conducting a connectivity check for a NetScaler Gateway server that has already been added before, the user name is provided.

5. Click **Add**. The NetScaler Gateway is added to the table on the **NetScaler Gateway Connectivity Checks** page.

6. Select the NetScaler Gateway server and then click **Test Connectivity**. The results appear in a test results table.

7. Select a server in the test results table to see detailed results for that server.

Support bundles

Jun 19, 2017

If you want to report an issue to Citrix or troubleshoot a problem, you can create a support bundle and then upload the support bundle to Citrix Insight Services (CIS).

1. In the XenMobile console, click the wrench icon in the right upper-hand corner. The **Support** page appears.
2. On the **Support** page, click **Create Support Bundles**. The **Create Support Bundles** page appears. If your XenMobile environment contains clustered nodes, all nodes are shown.

The image displays two screenshots of the XenMobile console's 'Create Support Bundles' page. The top screenshot shows the page with the 'Support Bundle for XenMobile' checkbox checked. Below it, the 'Support Bundle for*' dropdown is set to 'Cluster' with a checkmark, and the IP address '192.0.2.24' is displayed with a checkmark. The bottom screenshot shows the same page with the 'Support Bundle for*' dropdown set to '198.51.100.3'. The 'Include from database*' section is expanded, showing radio button options: 'No data' (selected), 'Custom data', 'Configuration data', 'Delivery group data', 'Devices and user info', and 'All data'. A note at the bottom of the second screenshot states 'Support data anonymization is turned on. To change anonymity settings? [Anonymization and de-anonymization](#)'. At the bottom right of the second screenshot, there is a green 'Create' button.

3. Make sure that the **Support Bundle for XenMobile** check box is selected.

4. If your XenMobile environment contains clustered nodes, in **Support Bundle for**, you can select all the nodes or any combination of nodes from which to draw data.

5. In **Include from database**, do one of the following:

- Click **No data**.
- Click **Custom data** and then select any or all of the following (by default, all options are selected):
 - **Configuration data**: Includes certificate configurations and device manager policies.
 - **Delivery group data**: Includes app delivery group information, containing app types and app delivery policy details.
 - **Devices and user info**: Includes device policies, apps, actions, and delivery groups.
- Click **All data**.

Note: If you choose **Devices and user info** or **All data**, and this is the first support bundle you have created, the **Sensitive Information Disclaimer** dialog box appears. Read the disclaimer and then click **Accept** or **Cancel**. If you click **Cancel**, the support bundle cannot be uploaded to Citrix. If you click **Accept**, you can upload the support bundle to Citrix and you will not see the disclaimer the next time you create a support bundle that includes device or user data.

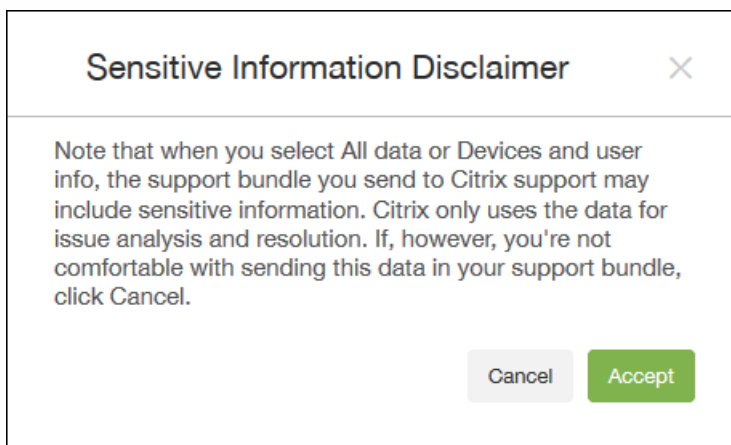

6. The **Support data anonymization is turned on** option indicates that the default setting is to anonymize the data, which means that sensitive user, server, and network data is made anonymous in support bundles.

To change this setting, click **Anonymization and de-anonymization**. For more information about data anonymization, see [Anonymizing data in support bundles](#).

7. Select the **Support Bundle for NetScaler Gateway** check box if you want to include support bundles from NetScaler Gateway and then do the following:

- a. Click **Add**. The **Add NetScaler Gateway Server** dialog box appears.

Add NetScaler Gateway Server

NetScaler Gateway Management IP*

User name*

Password*

b. In **NetScaler Gateway Management IP**, type the NetScaler management IP address for the NetScaler Gateway from which you want to draw your support bundle data.

Note: If you are creating a bundle from a NetScaler Gateway server that is already added, the IP address is provided.

c. In **User name** and **Password**, type the user credentials needed to access the server running NetScaler Gateway.

Note: If you are creating a bundle from a NetScaler Gateway server that is already added, the user name is provided.

7. Click **Add**. The new NetScaler Gateway support bundle is added to the table.

8. Repeat Step 7 to add more NetScaler Gateway support bundles.

9. Click **Create**. The support bundle is created and two new buttons, **Upload to CIS** and **Download to Client**, appear.

Uploading Support Bundles to Citrix Insight Services

After creating a support bundle, you can upload the bundle to Citrix Insight Services (CIS) or download the bundle to your computer. These steps show you how to upload the bundle to CIS. You need a MyCitrix ID and password to upload to CIS.

1. On the **Create Support Bundles** page, click **Upload to CIS**. The **Upload to Citrix Insight Services (CIS)** dialog box appears.

Upload to Citrix Insight Services (CIS)

CIS Website cis.citrix.com

User name* MyCitrix ID

Password* MyCitrix password

Associate with SR#

Cancel Upload

2. In **User Name**, type your MyCitrix ID.

3. In **Password**, type your MyCitrix password.

4. If you want to connect this bundle with an existing service request number, select the **Associate with SR#** check box and in the two new fields that appear, do the following:

- In **SR#**, type the eight-digit service request number you want to associate this bundle with.
- In **SR Description**, type a description of the SR.

5. Click **Upload**.

If this is the first time you have uploaded a support bundle to CIS, and you haven't created an account on CIS through another product and accepted the Data Collection and Privacy agreement, the following dialog box appears; you must accept the agreement before the upload can begin. If you have an account on CIS and have previously accepted the agreement, the support bundle is uploaded immediately.

Data Collection and Privacy

By uploading your data to Citrix pursuant to the instructions on this website, you are agreeing that Citrix may store, transmit and use technical and related information about your use of your Citrix products, including configuration information, number and types of users, error reports, features enabled, performance, version and patch management information, and non-personally identifiable usage statistics ("Collected Data") to facilitate the provisioning of product updates, support, education, self-help tools, market assessment and analysis, product development, invoicing and online services. Collected Data is subject to Citrix's Privacy Policy.

Cancel Agree and upload

6. Read the agreement and then click **Agree and upload**. The support bundle is uploaded.

Downloading support bundles to your computer

After you create a support bundle, you can upload the bundle to CIS or download the bundle to your computer. If you would like to troubleshoot the problem on your own, download the support bundle to your computer.

On the Create Support Bundles page, click Download to Client. The bundle is downloaded to your computer.

Anonymize data in support bundles

Jun 19, 2017

When you create support bundles in XenMobile, sensitive user, server, and network data is made anonymous by default. You can change this behavior on the Anonymization and De-anonymization page. You can also download a mapping file that XenMobile saves when anonymizing data. Citrix support may request this file to de-anonymize the data and locate a problem with a specific user or device.

1. In the XenMobile console, click the wrench icon in the right upper-hand corner. The **Support** page appears.
2. On the **Support** page, under **Advanced**, click **Anonymization and De-anonymization**. The **Anonymization and De-anonymization** page appears.

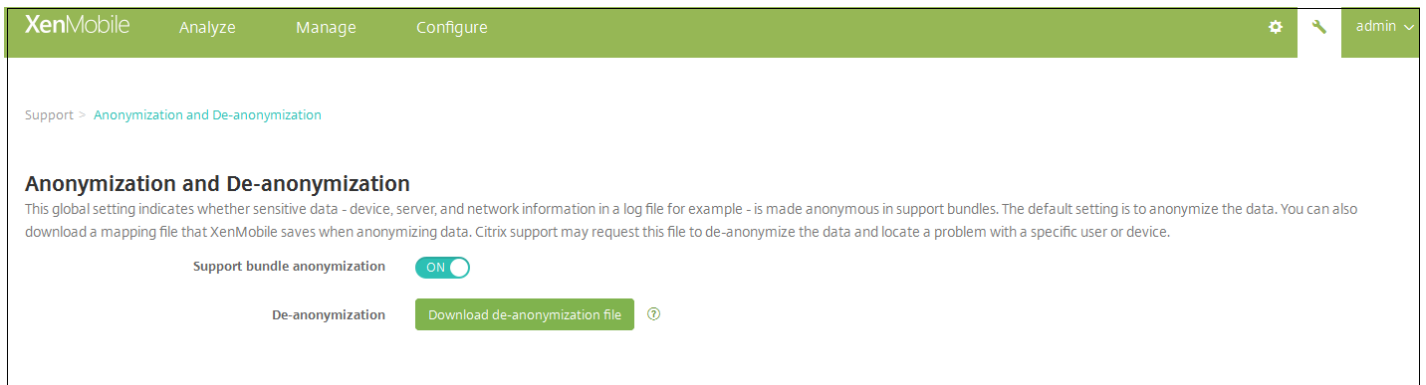

3. In **Support bundle anonymization**, select whether data is anonymized. The default is **ON**.
4. Next to **De-anonymization**, click **Download de-anonymization file** to download the mapping file to send to Citrix support when they need specific device or user information to diagnose an issue.

Logs

Jun 19, 2017

You can configure log settings to customize the output of logs that XenMobile generates. If you have clustered XenMobile servers, when you configure log settings in the XenMobile console, those settings are shared with all other servers in the cluster.

1. In the XenMobile console, click the wrench icon in the upper-right corner of the console. The **Support** page appears.
2. Under **Log Operations**, click **Log Settings**. The **Log Settings** page appears.

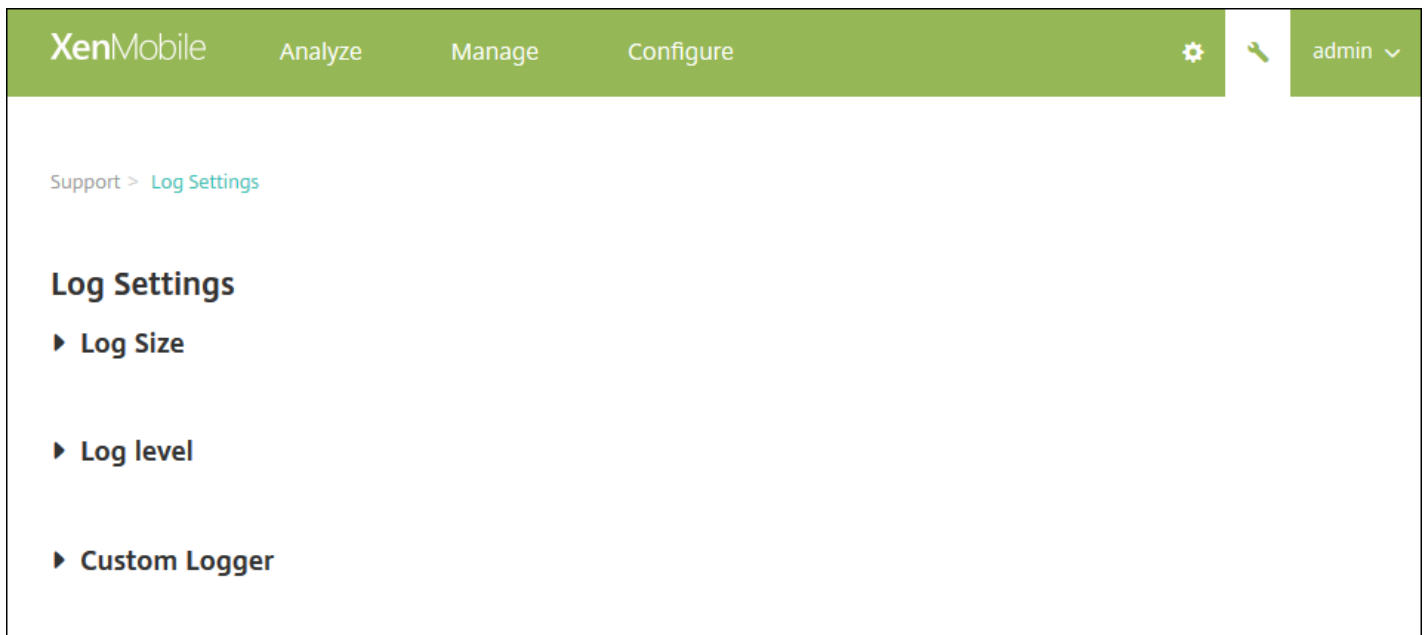

On the **Log Settings** page you can access the following options:

- **Log Size.** Use this option to control the size of the log file and the maximum number of log backup files retained in the database. Log size applies to each of the logs supported by XenMobile (debug log, Admin activity log, and user activity log).
- **Log level.** Use this option to change the log level or to persist settings.
- **Custom Logger.** Use this option to create a custom logger; custom logs require a class name and the log level.

To configure the Log Size options

1. On the **Log Settings** page, expand **Log Size**.

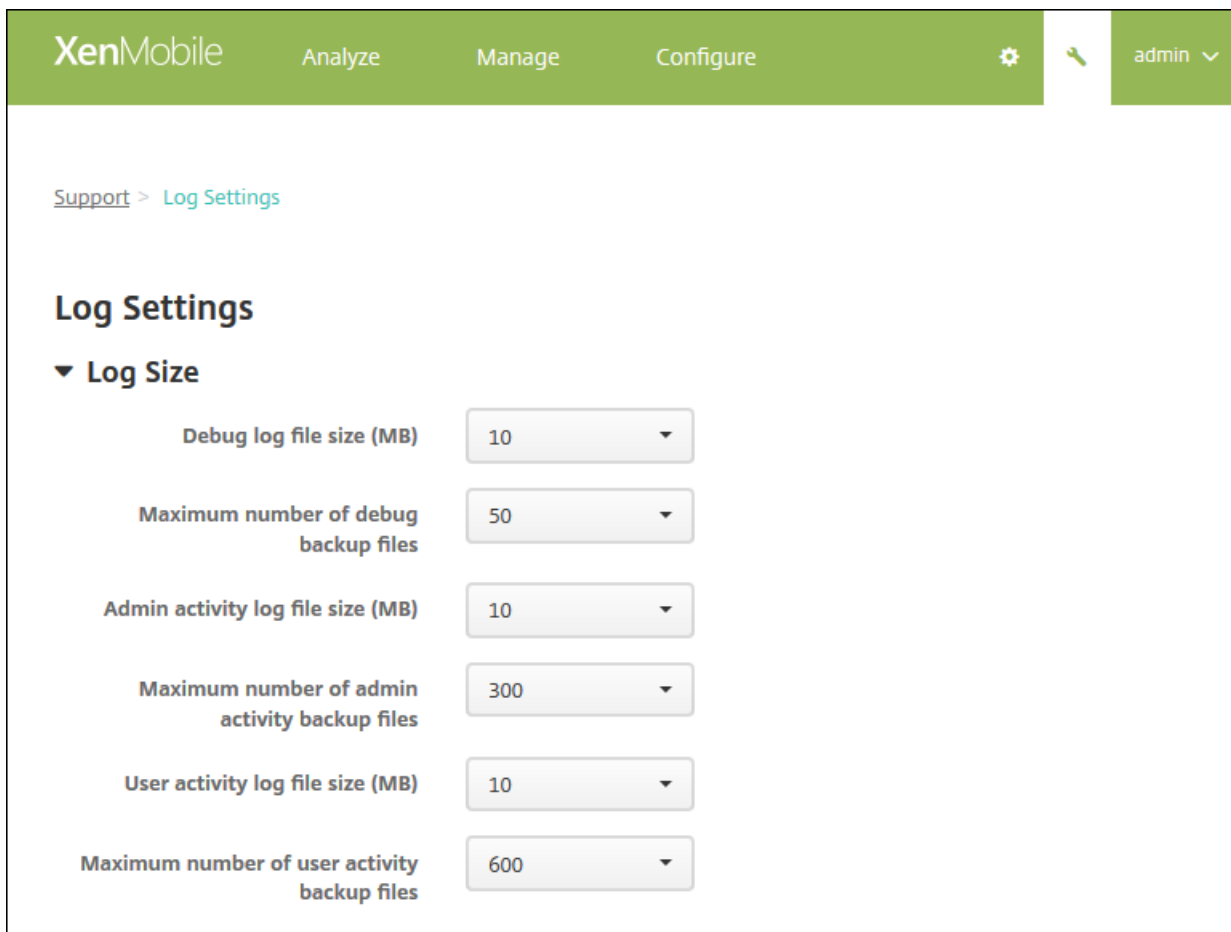



2. Configure these settings:

- **Debug log file size (MB):** In the list, click a size between 5 MB and 20 MB to change the maximum size of the debug file. The default file size is **10 MB**.
- **Maximum number of debug backup files:** In the list, click the maximum number of debug files retained by the server. By default, XenMobile retains 50 backup files on the server.
- **Admin activity log file size (MB):** in the list, click a size between 5 MB and 20 MB to change the maximum size of the admin activity file. The default file size is **10 MB**.
- **Maximum number of admin activity backup files:** In the list, click the maximum number of admin activity files retained by the server. By default, XenMobile retains 300 backup files on the server.
- **User activity log file size (MB):** In the list, click a size between 5 MB and 20 MB to change the maximum size of the user activity file. The default file size is **10 MB**.
- **Maximum number of user activity backup files:** In the list, click the maximum number of user activity files retained by the server. By default, XenMobile retains 300 backup files on the server.

To configure Log Level options

Log level lets you specify what type of information XenMobile collects in the log. You can set the same level for all classes or you can set individual classes to specific levels.

1. On the **Log Settings** page, expand **Log level**. The table of all log classes appears.



XenMobile Analyze Manage Configure   admin 

Support > [Log Settings](#)

Log Settings

▶ Log Size

▼ Log level

 Edit all |  Reset

<input type="checkbox"/>	Class	Sub-class	Log level	
<input type="checkbox"/>	Data Access	All	Info	
<input type="checkbox"/>	Data Access	XDM	Info	
<input type="checkbox"/>	Data Access	XAM	Info	
<input type="checkbox"/>	Data Access	Console	Info	
<input type="checkbox"/>	Data Access	OCA	Info	
<input type="checkbox"/>	IMI Services	All	Info	
<input type="checkbox"/>	IMI Services	Category Service	Info	
<input type="checkbox"/>	IMI Services	OPN Service	Info	

2. Do one of the following:

- Click the check box next to one Class and then, click **Set Level** to change just this class's log level.
- Click **Edit all** to apply the log level change to all classes in the table.

The **Set Log Level** dialog box appears where you can set the log level and select whether to have log level settings persist when you reboot the XenMobile server.

- **Class Name:** This field displays All when you are changing the log level for all classes or it displays the individual class name; it is not editable.
- **Sub-class name:** This field displays All when you are changing the log level for all classes or it displays the individual class sub-class name; it is not editable.
- **Log level:** In the list, click a log level. The supported log levels include:
 - Fatal
 - Error
 - Warning
 - Info
 - Debug
 - Trace
 - Off
- **Included Loggers:** This field is blank when you are changing the log level for all classes or it displays the currently configured loggers for an individual class; it is not editable.
- **Persist settings:** If you want the log level settings to persist when you reboot the server, select this check box. Not selecting this check box means that the log level settings revert to their defaults when you reboot the server.

3. Click **Set** to commit your changes.

To add a Custom Logger

1. On the **Log Settings** page, expand **Custom Logger**. The **Custom Logger** table appears. If you haven't added any custom loggers, the table is initially empty.

Support > [Log Settings](#)

Log Settings

▶ Log Size

▶ Log level

▼ Custom Logger

 Add |  Set Level |  Delete

<input type="checkbox"/>	Class	Logger	Log level	▼
<input type="checkbox"/>	Custom	All	Warning	
<input type="checkbox"/>	Custom	xms.oca.dao.hibernate	Trace	

Showing 1 - 2 of 2 items

2. Click **Add**. The **Add custom logger** dialog box appears.

Add custom logger

Custom

Fatal

3. Configure these settings:

- **Class Name:** This field displays **Custom**; it is not editable.
- **Log level:** In the list, click a log level. The supported log levels include:
 - Fatal
 - Error
 - Warning
 - Info
 - Debug
 - Trace
 - Off
- **Included Loggers:** Type the specific loggers you want to include in the custom logger or leave the field blank to include all loggers.

4. Click **Add**. The custom logger is added to the **Custom Logger** table.

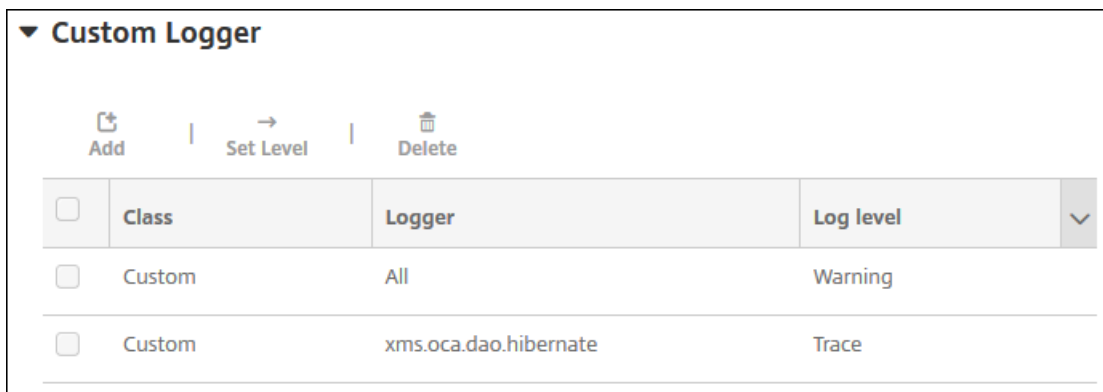

<input type="checkbox"/>	Class	Logger	Log level	▼
<input type="checkbox"/>	Custom	All	Warning	
<input type="checkbox"/>	Custom	xms.oca.dao.hibernate	Trace	

To delete a Custom Logger

1. On the **Log Settings** page, expand **Custom Logger**.
2. Select the custom logger you want to delete.
3. Click **Delete**. A dialog box appears asking whether you want to delete the custom logger. Click **OK**.

Important: You cannot undo this operation.

XenMobile Analyzer Tool

Jul 17, 2017

XenMobile Analyzer is a cloud-based tool that you can use to diagnose and troubleshoot XenMobile-related issues with configuration and other features. The tool checks for device or user enrollment and authentication issues within your XenMobile environment.

Configure the tool to point to your XenMobile Server and provide information, such as server deployment type, mobile platform, authentication type, and user credentials. The tool then connects to the server and scans your environment for configuration issues. If XenMobile Analyzer discovers issues, the tool provides recommendations to correct the issues.

In this article:

- [Accessing and starting the XenMobile Analyzer](#)
- [Performing an environment check](#)
- [Performing a NetScaler check](#)
- [Adding a schedule to environment checks](#)
- [Performing other informative checks](#)
- [Known issues](#)
- [Fixed issues](#)

Key features

- Secure, cloud-based micro-service to troubleshoot all XenMobile related issues.
- Accurate recommendations to resolve XenMobile configuration issues.
- Reduced support calls and accelerated troubleshooting of XenMobile environments.
- Zero-day support for XenMobile Server releases.
- Health check scheduling on a daily or weekly cadence.
- NetScaler configuration checks.
- Secure Web tests for reachability to intranet sites.
- Secure Mail autodiscovery service checks.
- ShareFile single sign-on (SSO) checks.

What's new

- The NetScaler Configuration Report displays a badge notification indicating the number of recommendations. The recommendations are based on the Essential Configuration checks on a particular NetScaler Gateway.
- The icons within the global navigation bar on the Test Environment List page have now been reordered for better user experience.

The following video highlights the navigation changes in the user interface.

Citrix XenMobile Analyzer: New Environment List UI

Note: This video contains no audio sound. It is best viewed in full screen mode.

Accessing and starting the XenMobile Analyzer

Prerequisites

Product	Supported Version
XenMobile Server	10.3.0 and later
NetScaler Gateway	10.5 and later
Client Enrollment Simulation	iOS and Android

Access the XenMobile Analyzer by using either of these methods:

- In the XenMobile console, click the wrench icon in the upper-right corner to open the **Troubleshooting and Support** page.
- Use your My Citrix credentials to access the tool from <https://xenmobiletools.citrix.com>. On the XenMobile Management Tools page that appears, to start XenMobile Analyzer, click **Analyze and Troubleshoot my XenMobile Environment**.

All Management Tools

What do you want to do?

XenMobile Management Tools can help you troubleshoot your XenMobile Server set up and enable key features in your XenMobile deployment.

Analyze and
Troubleshoot my
XenMobile
environment

XenMobile Analyzer



Follow steps to identify and triage potential issues with your deployment.

Request Auto
Discovery

Auto Discovery Service



Request and Configure Auto Discovery for your domain's XenMobile Server.

Request push
notification
certificate
signature

Create APNs Certificate



Submit a request to Citrix to sign an APNs certificate, which you then submit to Apple.

Enable APNs-based

XenMobile Analyzer contains five options designed to lead you through the triage process and reduce the number of support tickets. The options can lower costs for everyone.

The options are as follows:

- **Environment Check** - This step guides you in setting up tests to check your setup for issues. The step also provides recommendations and solutions on device, user enrollment, and authentication issues.
- **NetScaler Check** - This step guides you in checking your NetScaler configurations for XenMobile deployment readiness.
- **Advanced Diagnostics** - This step provides information on using Citrix Insight Services to find further issues that the environment check might have missed.
- **Secure Mail Readiness** - This step directs you to download the XenMobile Exchange ActiveSync Test application. This tool helps troubleshoot the ActiveSync servers for their readiness to be deployed with a XenMobile environment.
- **Server Connectivity Checks** - This step instructs you to test the connectivity of your servers.
- **Contact Citrix support** - If you are still having issues, this step links you to the site where you can create a Citrix support case.

The following sections describe each option in more detail.

Performing an environment check

1. Log on to XenMobile Analyzer and click **XenMobile Environment**.

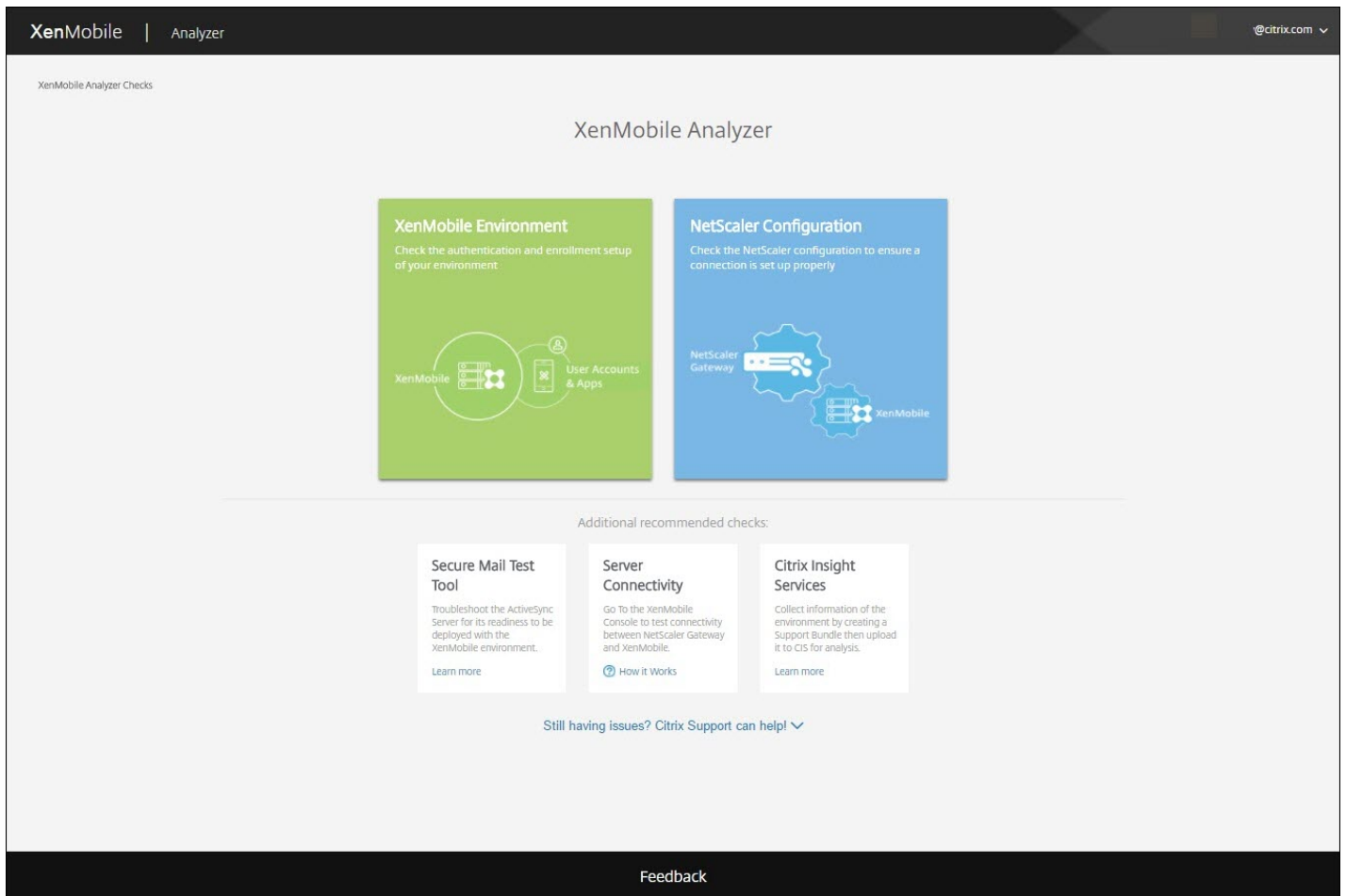

2. Click **Add Test Environment**.

3. In the new **Add Test Environment** dialog box, do the following:

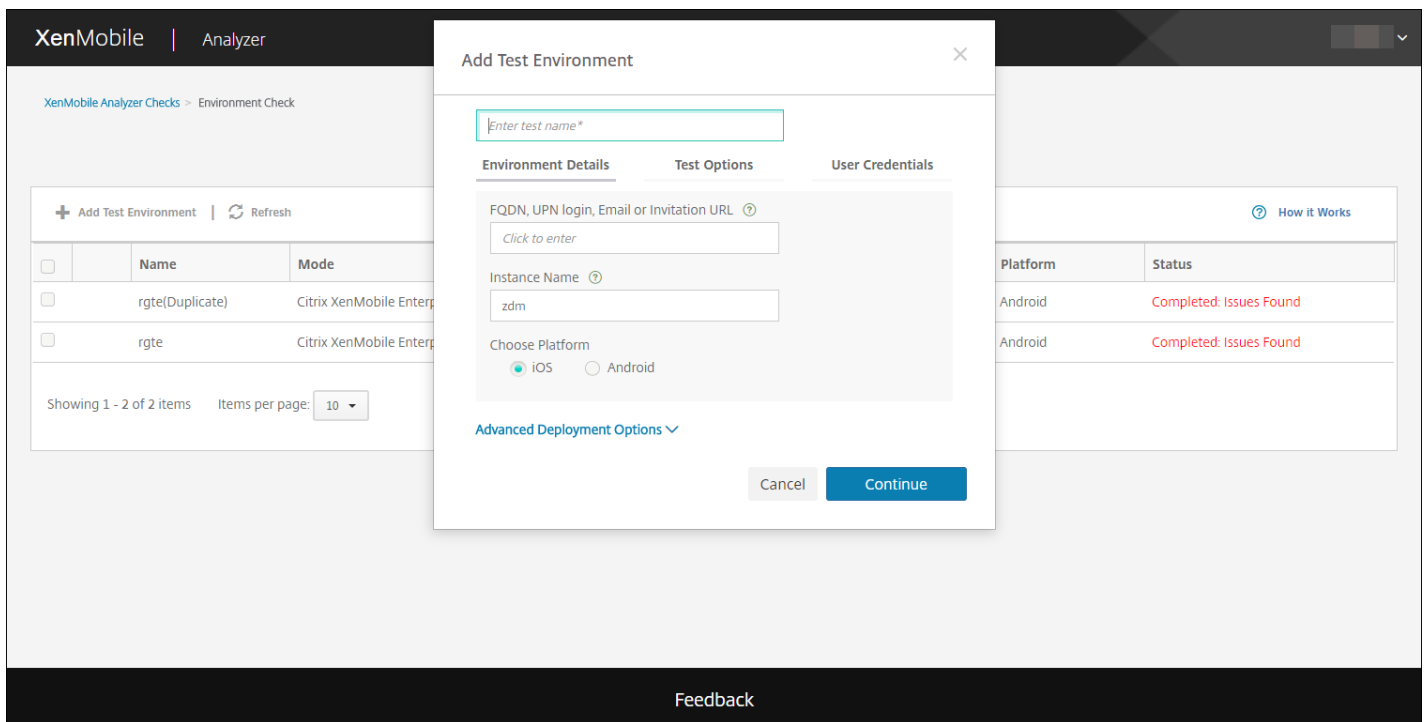

- a. Provide a unique name for the test that will help identify the test in the future.
- b. In **FQDN, UPN login, Email or URL Invitation**, enter the information that is used to access the server.
- c. In **Instance Name**, if you use a custom instance, you can provide that value.
- d. In **Choose Platform**, select either **iOS** or **Android** as the platform for testing.
- e. If you expand **Advanced Deployment Options**, in the **Deployment Mode** list, you can select your XenMobile deployment mode. Available options are **Enterprise (MDM + MAM)**, **App Management (MAM)**, or **Device Management (MDM)**.
- d. Click **Continue**.

4. On the **Test Options** tab, choose one or more of the following tests and then click **Continue**.

- a. **Secure Web Connectivity**. Provide an intranet URL. The tool tests for the reachability of the URL. This test detects if there are any connectivity issues that may potentially occur in the Secure Web app while trying to reach intranet URLs.
- b. **Secure Mail ADS**. Provide a user email ID. This ID is used to test the autodiscovery of the Microsoft Exchange Server in your XenMobile environment. It detects if there are any issues related to Secure Mail Auto Discovery.
- c. **ShareFile SSO**. If selected, XenMobile Analyzer tests if the ShareFile DNS resolution happens successfully. The tool also checks if ShareFile single sign-on (SSO) is compatible with the provided user credentials.

Add Test Environment [Close]

testdev02

Environment Details | **Test Options** | User Credentials

Apps connectivity testing (optional)

Secure Web connectivity ? ShareFile SSO ?

Secure Mail ADS ?

Back Continue

5. On the **User Credentials** tab, depending on your server setup, you see different fields. The possible fields are **Username**, **Username and Password**, or **Username, Password, and Enrollment PIN**.

Add Test Environment [Close]

testdev02

Environment Details | Test Options | **User Credentials**

Secure Hub User Credentials ?

Note: XenMobile Analyzer tool does not store credentials.

Username ?

Password

Back Save & Run

6. Click **Save & Run** to start the tests.

A progress notification appears. You can leave the progress dialog box open or close the dialog box and the tests continue to run.

Tests that have passed appear in green. Tests that fail appear as red.

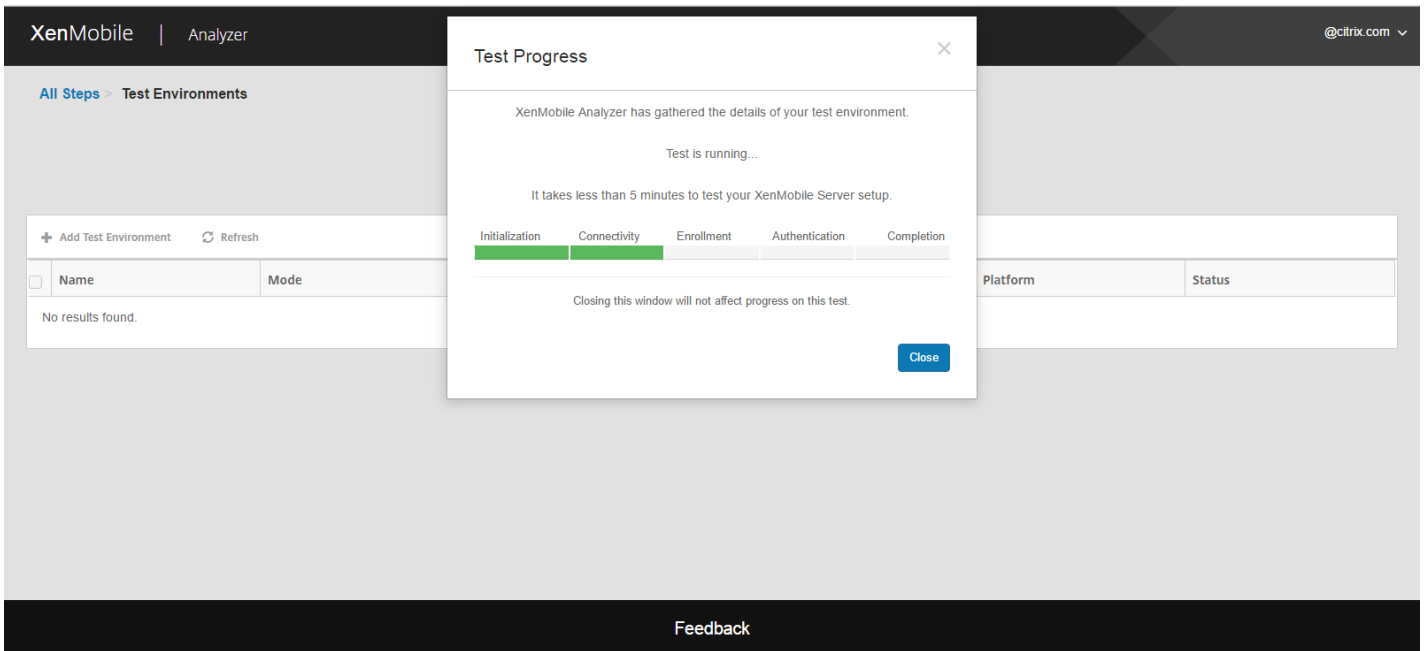

After closing the progress dialog box, you return to the **Environments List** page.

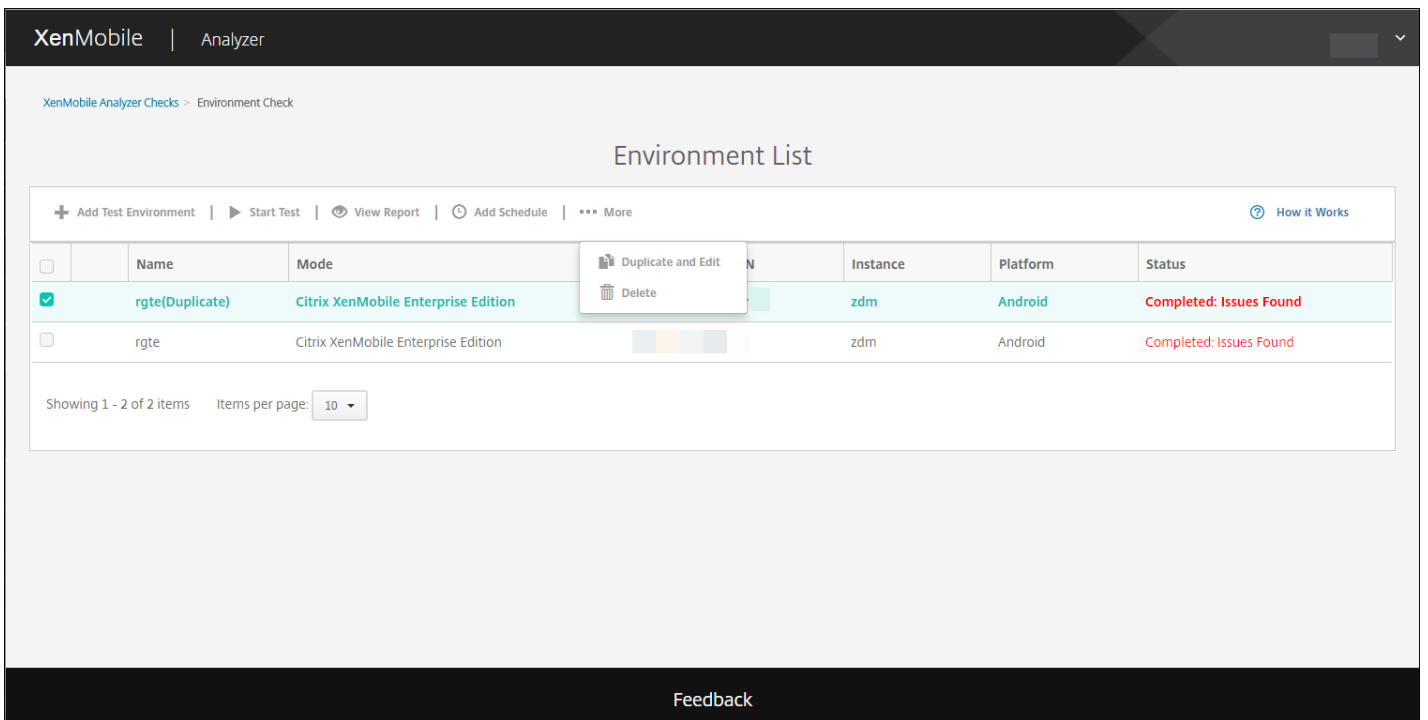

The **Results** page shows Test Details, Recommendations, and Results.

7. Click the **View Report** icon to see test results.

If recommendations have Citrix Knowledge Base articles associated with them, the articles are listed on this page.

8. Click the **Results** tab to display the individual Category and Tests that the tool performed, with their results.

- a. To download the report, click **Download Report**.
- b. To return to the list of test environments, click **Environment Check**.
- c. To rerun the same test, click **Run Again**.
- d. If you want to rerun another test, go back to **Test Environments**, select the test, and click **Start Test**.
- e. To select another XenMobile Analyzer option, click **Go To XenMobile Analyzer Checks**.

Check Report

Check Complete: No Issues Found

Check Summary

Test Environment: testdoc
 Start Time: 2017-Jun-07 12:26 PM UTC
 Deployment Mode: Citrix XenMobile Enterprise Edition
 Server FQDN: navin.mathew@citrix.com
 Platform: IOS

[Edit Schedule](#)

[Run Again](#)

Do you need assistance?

[Citrix Support is here to help!](#)

For additional information, please refer to the [Support Knowledge Center](#)

Download and share this report with your Citrix Support contact.

[Download Report](#)

Next, continue troubleshooting the XenMobile Environment using additional recommended checks:

Troubleshoot the ActiveSync server using Secure Mail Test Tool.

Test connectivity of XenMobile Server and NetScaler Gateway.

Analyze logs and scan for known issues using Citrix Insight Services.

[Go to XenMobile Analyzer Checks](#)

Detailed Results

View all details of your test

	Category	Checks	Results
✓	Initialization and Connectivity	XenMobile Server FQDN DNS Resolution	Pass
		XenMobile Server FQDN Connectivity	Pass
		XenMobile Server Certificate Validation	Pass
		XenMobile Server instance name validation	Pass
✓	Enrollment	Enrollment Authentication	Pass
		XenMobile Enrollment	Pass
✓	Authentication	Is NetScaler Gateway configured?	Yes
		NetScaler Gateway Cert Auth Enabled?	No
		NetScaler Gateway DNS Resolution	Pass
		NetScaler Gateway Connectivity	Pass
		NetScaler Gateway Certificate Validation	Pass
		NetScaler Gateway Login	Pass
		XenMobile Server connectivity through NetScaler Gateway	Pass
		XenMobile Server Authentication	Pass
✓	App Enumeration	Store Connectivity	Pass
		Device Registration	Pass
		Store App Listing	Pass
⚠	Secure Web Connectivity	NetScaler Gateway DNS Resolution	Not Tested
		NetScaler Gateway server connectivity	Not Tested
⚠	ShareFile	ShareFile Subdomain Discovery	Not Tested
		ShareFile SAML SSO	Not Tested
⚠	Secure Mail ADS	Secure Mail Auto Discovery	Not Tested
✓	Logout	XenMobile Server Logout	Pass
		NetScaler Gateway Logout	Pass

[Feedback](#)

9. From the Test Environments page, you can copy and edit tests. To do so, select a test and then click **More** and select **Duplicate and Edit**.

A copy of the selected test is created and the Add Test Environment dialog opens, allowing you to modify the new test.

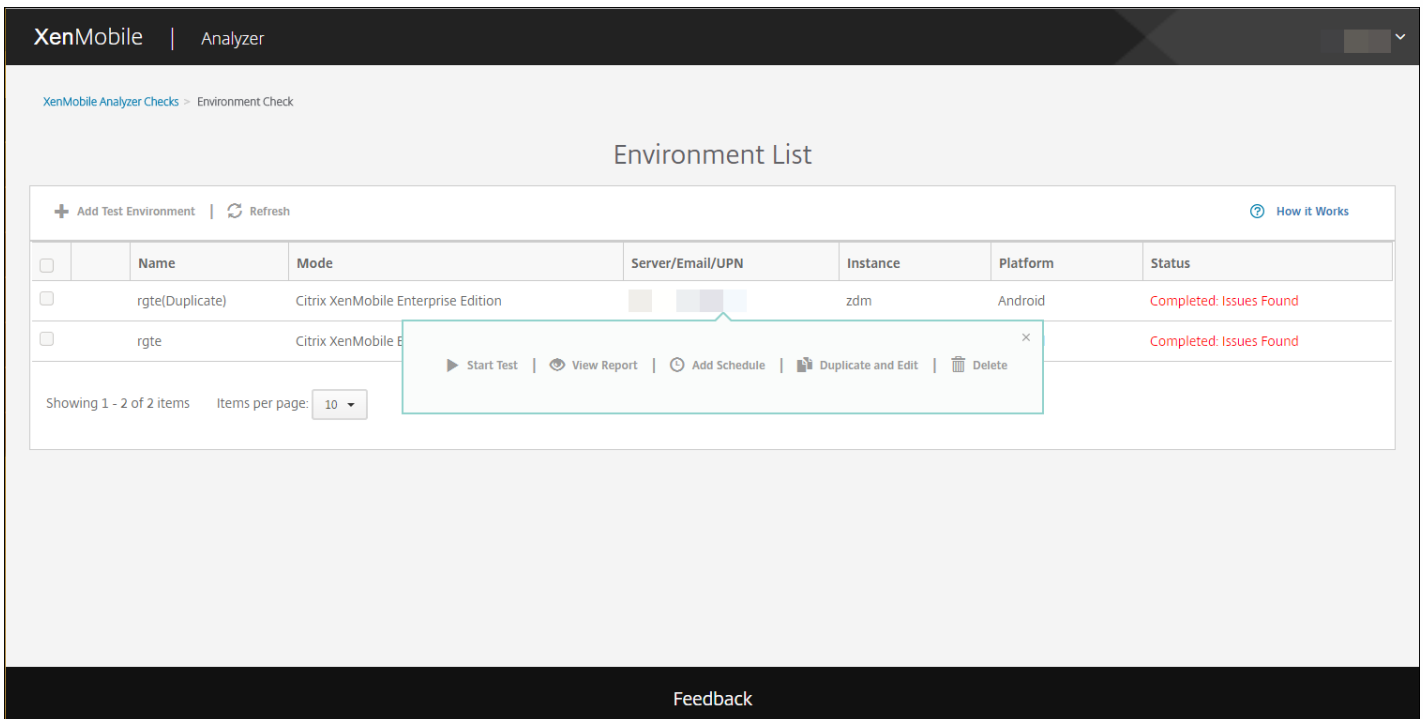
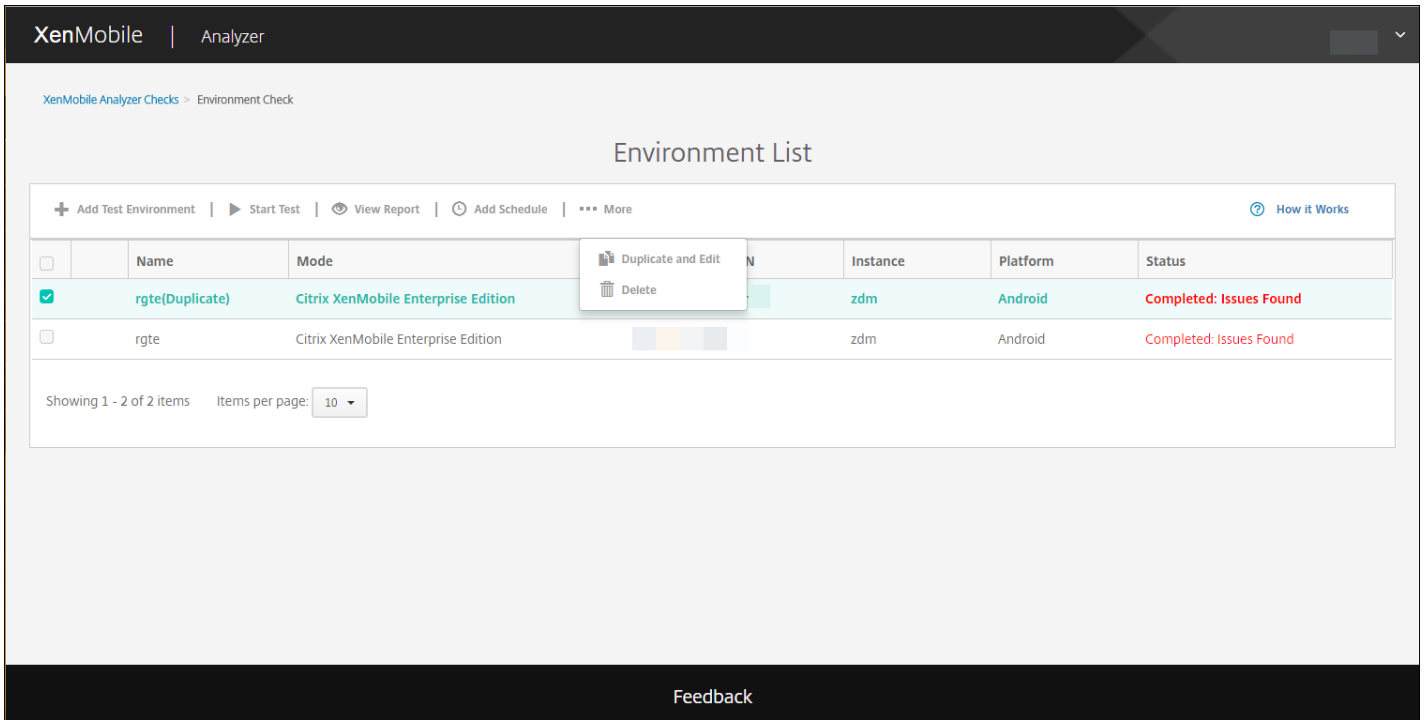

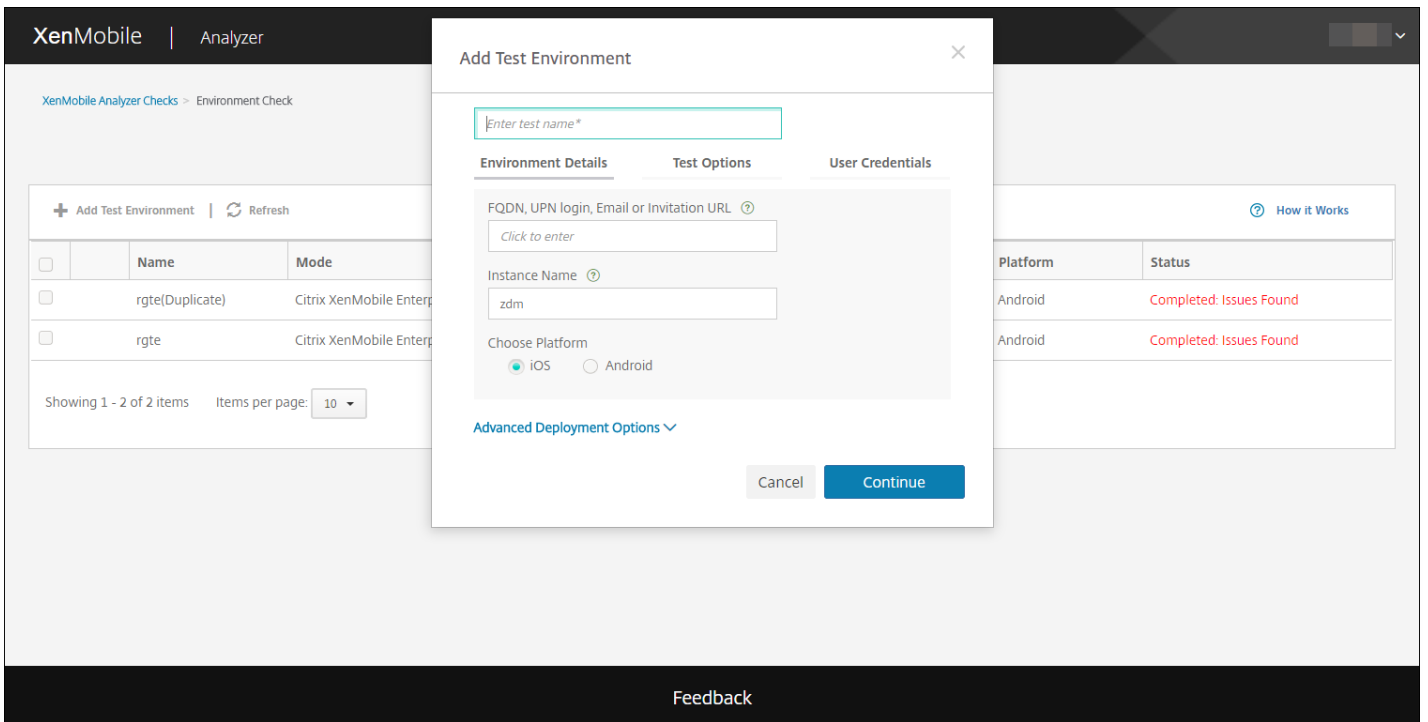

Adding a schedule to environment checks

You can configure tests to run on an automatic schedule with results sent to a list of users you configure.

1. On the **Environment List** page, select the environment for which you want to set up a schedule and click **Add Schedule**.

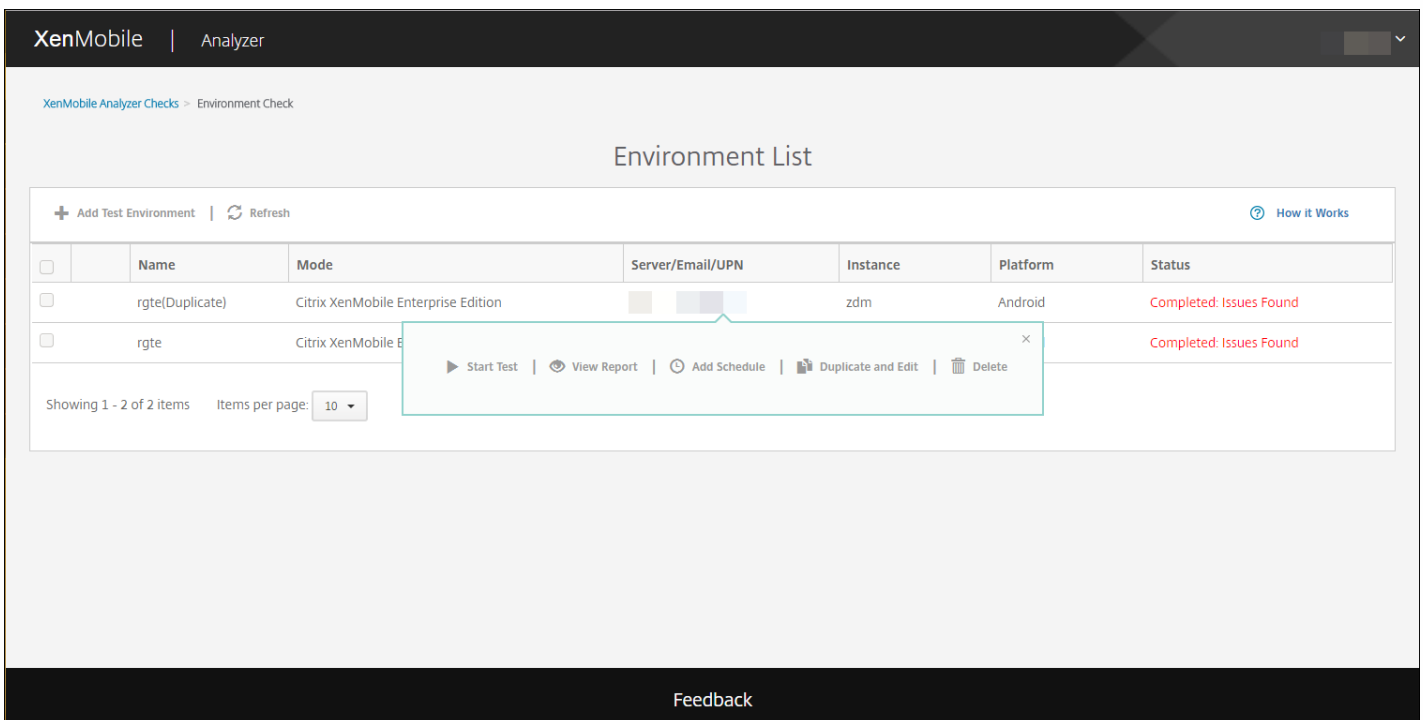

2. The **Add Schedule** window displays a message warning you that XenMobile Analyzer saves credentials for running

tests on a schedule. Citrix recommends that you use an account with limited access for running scheduled tests. Click **I Agree** to continue.

The screenshot shows a dialog box titled "Add Schedule" with a close button (X) in the top right corner. Below the title bar, the text "Read before proceeding:" is displayed. The main content area contains the following text: "XenMobile Analyzer saves credentials for running checks on a schedule. Citrix recommends that you use low security risk user credentials, such as that of a limited access group." Below this text is a checkbox labeled "Don't show this alert again" which is currently unchecked. At the bottom left is a "Cancel" button, and at the bottom right is a blue "I Agree" button.

3. Enter a **Username** and **Password** for running the test.

The screenshot shows the "Add Schedule" dialog box with the "Enter credentials for the check" section expanded. The "Test Name" is "testdoc". The "Environment Information" section includes fields for "FQDN, UPN Login, Email" (with a blurred input), "Instance Name" (with "zdm" entered), and "Platform" (with "iOS" selected). The "Secure Hub User Credentials" section includes a "Username" field with the placeholder "Enter user account to test" and a "Password" field with the placeholder "Enter password for user account". A note below the password field states "Note: Citrix stores this password securely". At the bottom left is a "Cancel" button, and at the bottom right are "Back" and "Continue" buttons.

4. Configure a schedule for the test to run. You can select **Daily** or **Weekly** from the drop-down. Select a time of day for the test to run and a time zone. Use the date picker to select a date for the scheduled test to stop running or leave it blank for the test to run indefinitely. Enter a list of email addresses to receive reports, separated by commas. Click **Save**.

Add Schedule

When should it run?
Daily 6:15 PM [Time Zone]

When should it end?
Never [Calendar]

Recipients
Enter email addresses to receive reports, separated by commas.

Cancel Back Save

5. A clock symbol to the left of your test indicates that a schedule is configured. If you select your test, you can click **Edit Schedule** to change when the test runs.

XenMobile | Analyzer

XenMobile Analyzer Checks > Environment Check

Environment List

+ Add Test Environment Refresh Learn about Add Schedule How it Works

	Name	Mode	Server/Email/UPN	Instance	Platform	Status
<input type="checkbox"/>	testdoc	Citrix XenMobile Enterprise Edition	@citrix.com	zdm	iOS	Completed: No Issues Found

Showing 1 - 1 of 1 items Items per page: 10

Start Test View Report Delete Duplicate and Edit Edit Schedule

Feedback

6. In this window, you can change when the test runs. You can also disable it, by clicking the switch at the top. Click **Save** when you're done.

Run checks automatically during this schedule ON
You can turn on/off schedule at any time.

When should it run?
Daily 6:15 PM (UTC-11:00) Midway Island, Samoa

When should it end?
06/08/2017

Recipients
@citrix.com

Cancel Edit Credentials Save

Performing a NetScaler check

1. Log on to XenMobile Analyzer and then click **NetScaler Configuration**.



2. Upload the latest ns.conf file from your instance of NetScaler. You can either drag the file into the upload box or click **Browse** to search and add the ns.conf file. For more information on how you can download the latest ns.conf file, see the [Support Knowledge Center](#).

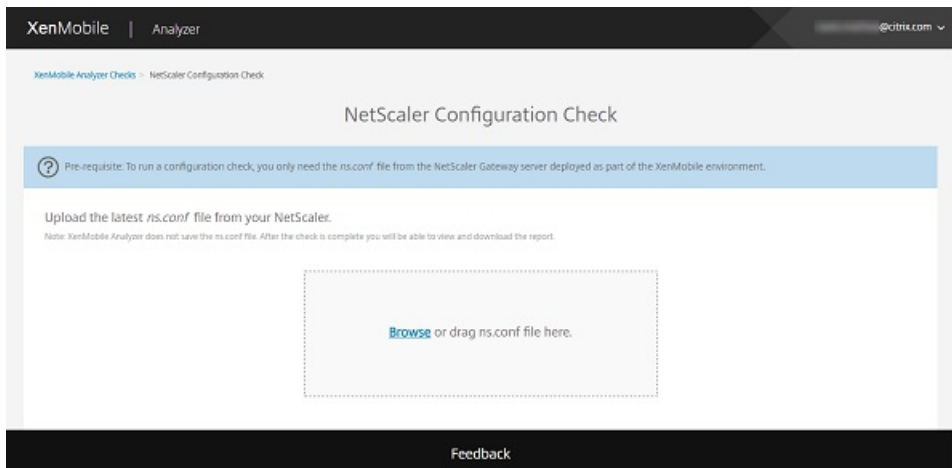

Note

XenMobile Analyzer does not save the ns.conf file. After the check is complete, you can view and download the report.

3. Click **Run Check**.

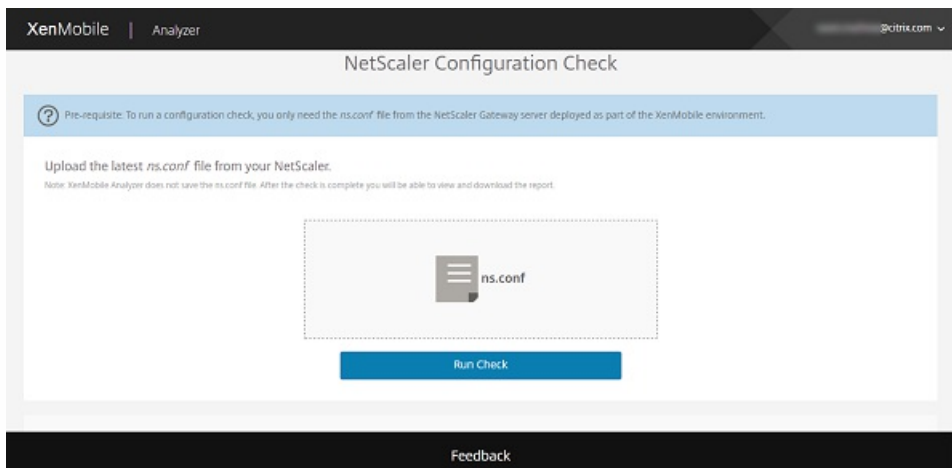

XenMobile Analyzer runs two types of configuration checks.

- Essential Checks looks for components that are critical for a successful XenMobile deployment.
- Advanced Checks looks for components that are not critical, but are complementary to XenMobile deployments.

4. To view recommendations on Essential and Advanced Checks for NetScaler, click **View Report**.

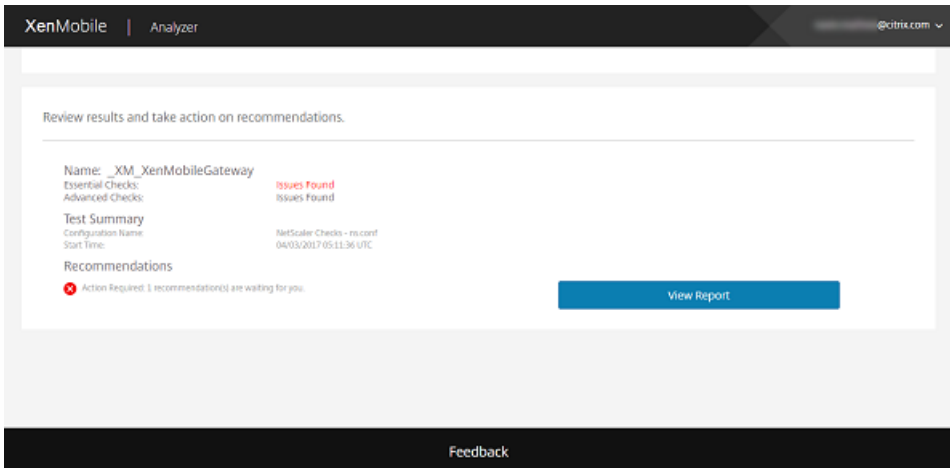

The **Configuration Report** page appears.

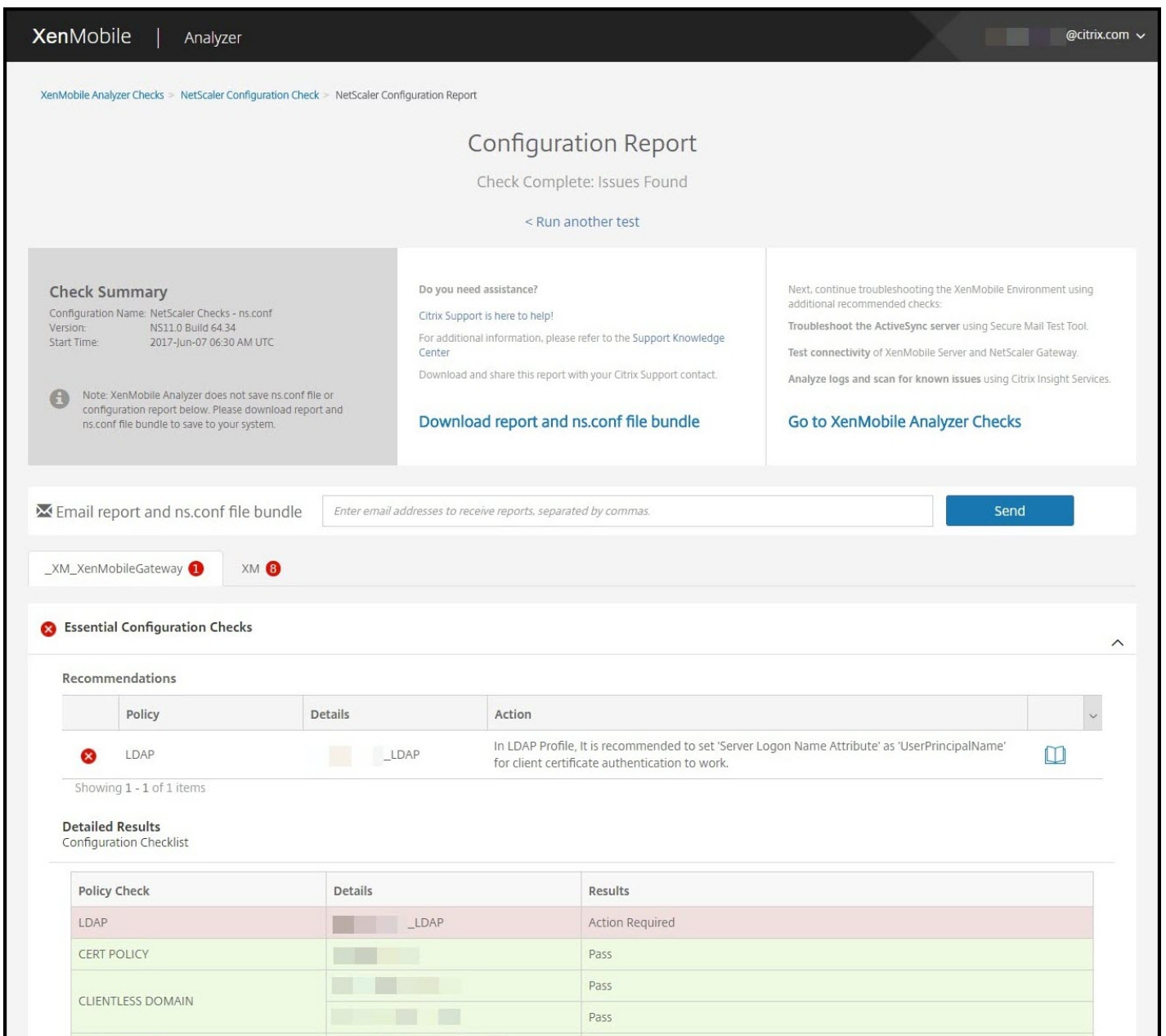

CLIENT COOKIE		Pass
DNS		Pass
		Pass
		Pass
DNS SUFFIX		Pass
MAM LB		Pass
SMART ACCESS MODE	ENABLED	Pass
STA		Pass
XENMOBILE CLIENTLESS		Pass
XENMOBILE SESSION		Pass
XMS		Pass

Advanced Configuration Checks



Recommendations

	Policy	Details	Action	
	SHAREFILE	Not Configured	Ensure that the ShareFile URL has been configured and bound either globally or to the virtual server.	
	SHAREFILE AUTH	Not Configured	Ensure that a valid LDAP authentication policy is bound to the sharefile authentication virtual server.	
	SHAREFILE AUTH	Not Configured	Ensure that a sharefile authentication virtual server is configured.	
	SHAREFILE AUTH	Not Configured	Ensure that LDAP Authentication policy is created and associated with a valid LDAP profile.	
	SHAREFILE AUTH	Not Configured	Primary Authentication Profile is missing.	
	SHAREFILE STORAGE ZONE LB	Not Configured	Load Balancing virtual server corresponding to Sharefile Storage Zone is not configured.	
	SHAREFILE STORAGE ZONE LB	Not Configured	No Sharefile Zone Controller configured for load balancing.	
	SHAREFILE STORAGE ZONE LB	Not Configured	Ensure that a valid CS vserver is configured for Sharefile Storage Zone Controller.	
	SPLIT TUNNEL	Not Configured	Ensure that a valid Intranet Application is added.	
	SPLIT TUNNEL	Not Configured	Ensure that a valid Intranet Application is bound to the virtual server.	

Showing 1 - 10 of 12 items

Showing 1 of 2

Detailed Results

Configuration Checklist

Policy Check	Details	Results
SHAREFILE	Not Configured	Action Recommended
SHAREFILE AUTH	Not Configured	Action Recommended
SHAREFILE STORAGE ZONE LB	Not Configured	Action Recommended
SPLIT TUNNEL	Not Configured	Action Recommended
XNC SERVER	Not Configured	Action Recommended
MDM LB		Pass
		Pass

Feedback

Note

XenMobile Analyzer supports gateway servers configured through the NetScaler wizard. NetScaler Gateway instances always have the following title convention: ‘_XM_*name-provided-by-user-when-deploying’.

The overall status is a Success when the essential configuration checks have passed.

When an Essential Configuration check fails, the Recommendations table lists the **Policy, Details, and Results (Action Required)**.

When an Advanced Configuration check fails, the Recommendations table lists the **Policy, Details, and Results (Action Recommended)**.



The notification badge within the Configuration Report indicates the number of recommendations in the Essential Configuration check for gateway servers configured through the NetScaler wizard and user-configured Gateways.

On the **Configuration Report** page, the following options are available.

- a. To view the details, click **Essential Configuration Checks/Advanced Configuration Checks** (or the expand icon).
- b. To run another NetScaler configuration check, click **Run another test**.
- c. To view other troubleshooting and analyzing tools, click **Go to XenMobile Analyzer Checks**.
- d. To download a report of the results, click **Download report and ns.conf file bundle** or in **Email report and ns.conf bundle**, type your email address. Then, click **Send**.

Performing other informative checks

You interact with the Environment Check step of XenMobile Analyzer directly to perform tests, whereas the other options are informative. Each of these options provides information concerning other support tools you can use to ensure that your XenMobile environment is set up correctly.

- **Advanced Diagnostics:** Instructs you to collect information on your environment and then upload the information to Citrix Insight Services. The tool analyzes your data and provides a personalized report with recommended resolutions.
- **Secure Mail Readiness:** Directs you to download and run the XenMobile Exchange ActiveSync Test application. The application troubleshoots ActiveSync servers for their readiness to be deployed with XenMobile environments. After the application runs, you can view reports or share them with others.
- **Server Connectivity Checks:** Provides you with instructions for checking your connections to XenMobile, Authentication, and ShareFile servers.
- **Contact Citrix support:** If all else fails, you can create a support ticket with Citrix support.

Known Issues

The following issues are known in the XenMobile Analyzer:

- When performing the Secure Web Connectivity checks, typing multiple URLs in the text box is not supported.
- The shared devices authentication feature of Secure Hub is not supported.
- Secure Web tests only check the connectivity to the URLs entered and not the authentication to the corresponding sites.

Fixed Issues

The following issues with XenMobile Analyzer have been fixed:

- When performing a check using enrollment invitation, the test passes but the enrollment invitation is not redeemed.

View and analyze log files in XenMobile

Jun 19, 2017

1. In the XenMobile console, click the wrench icon in the upper-right corner of the console. The **Support** page opens.
2. Under **Log Operations**, click **Logs**. The **Logs** page appears. Individual logs appear in a table.

XenMobile Analyze Manage Configure administrator ▾

Support > Logs

Logs

Analyze the details of various types of logs.

Download All

<input type="checkbox"/>	Log Name	Log Type	▾
<input type="checkbox"/>	Debug Log File	Debug	
<input type="checkbox"/>	Admin Audit Log File	Admin Activity	
<input type="checkbox"/>	User Audit Log File	User Activity	

Showing 1 - 3 of 3 items

3. Select the log you want to view:

- Debug Log Files contain information useful for Citrix Support, such as error messages and server-related actions.
- Admin Audit Log Files contain audit information about activity on the XenMobile console.
- User Audit Log Files contain information related to configured users.

4. Use the actions at the top of the table to download all, view, rotate, download a single log, or delete the selected log.

Logs

Analyze the details of various types of logs.

 Download All |
  View |
  Rotate |
  Download |
  Delete

<input type="checkbox"/>	Log Name	Log Type
<input checked="" type="checkbox"/>	Debug Log File	Debug

Note:





- If you select more than one log file, only **Download All** and **Rotate** are available.
- If you have clustered XenMobile servers, you can only view the logs for the server to which you are connected. To see logs for other servers, use one of the download options.

5. Do one of the following:

- **Download All:** The console downloads all the logs present on the system (including debug, admin audit, user audit, server logs, and so on).
- **View:** Shows the contents of the selected log below the table.
- **Rotate:** Archives the current log file and creates a new file to capture log entries. A dialog box appears when archiving a log file; click Rotate to continue.
- **Download:** The console downloads only the single log file type selected; it also downloads any archived logs for that same type.
- **Delete:** Permanently removes the selected log files.

Logs

Analyze the details of various types of logs.

 Download All |
  View |
  Rotate |
  Download |
  Delete

<input type="checkbox"/>	Log Name	Log Type
<input checked="" type="checkbox"/>	Debug Log File	Debug
<input type="checkbox"/>	Admin Audit Log File	Admin Activity
<input type="checkbox"/>	User Audit Log File	User Activity

Showing 1 - 3 of 3 items

Log contents for Debug Log File

```

2016-11-06T06:28:38.908-0800 | INFO | node.scheduled.executor-8 | com.citrix.feature.FeatureManagerFactory | Enabling local feature management
2016-11-06T06:29:38.926-0800 | INFO | node.scheduled.executor-10 | com.citrix.feature.FeatureManagerFactory | Enabling local feature management
2016-11-06T06:30:38.762-0800 | INFO | node.pooled.executor2 | com.citrix.cg.task.handlers.NonPrvsnTask | Begin method executeNonPrvsnTaskJob: Sun Nov 06 06:45:38 PST 2016
2016-11-06T06:30:38.766-0800 | INFO | node.pooled.executor2 | com.citrix.cg.task.handlers.NonPrvsnTask | The number of non provision tasks Picked 2.
2016-11-06T06:30:38.945-0800 | INFO | node.scheduled.executor-2 | com.citrix.feature.FeatureManagerFactory | Enabling local feature management
2016-11-06T06:31:38.965-0800 | INFO | node.scheduled.executor-9 | com.citrix.feature.FeatureManagerFactory | Enabling local feature management
2016-11-06T06:32:38.985-0800 | INFO | node.scheduled.executor-4 | com.citrix.feature.FeatureManagerFactory | Enabling local feature management
2016-11-06T06:33:39.3-0800 | INFO | node.scheduled.executor-2 | com.citrix.feature.FeatureManagerFactory | Enabling local feature management
2016-11-06T06:34:39.24-0800 | INFO | node.scheduled.executor-8 | com.citrix.feature.FeatureManagerFactory | Enabling local feature management
2016-11-06T06:35:39.42-0800 | INFO | node.scheduled.executor-5 | com.citrix.feature.FeatureManagerFactory | Enabling local feature management
2016-11-06T06:36:39.502-0800 | INFO | pool-7-thread-1 | com.zenoss.zdm.pli.pers.CsrResponderService | Reloading OCSP Service data

```

REST APIs

Jun 19, 2017

With the XenMobile REST API, you can call services that are exposed through the XenMobile console. You can call REST services by using any REST client. The API does not require you to sign on to the XenMobile console to call the services.

For the complete current set of available APIs, download the [XenMobile Public API for REST Services](#) PDF.

Permissions required to access the REST API

Access to the REST API requires one of the following permissions:

- Public API access permission set as part of role-based access configuration. For information on setting role-based access, see [Configuring roles with RBAC](#).
- Super user permission

To invoke REST API services

You can invoke REST API services by using the REST client or CURL commands. The following examples use the Advanced REST client for Chrome.

Note

In the following examples, change the host name and port number to match your environment.

Login

URL: `https://<host-name>:<port-number>/xenmobile/api/v1/authentication/login`

Request: `{ "login":"administrator", "password":"password" }`

Method type: POST

Content type: application/json

https://localhost:4443/xenmobile/api/v1/publicapi/login

GET
 POST
 PUT
 PATCH
 DELETE
 HEAD
 OPTIONS
 Other

Raw Form Headers

Raw Form Files (0) Payload

Encode payload Decode payload

```

{
  "login": "administrator",
  "password": "password"
}

```

application/json Set "Content-Type" header to overwrite this value.

Clear Send

Status **200 OK** Loading time: 265 ms

Request headers

- User-Agent: Mozilla/5.0 (Windows NT 6.3; WOW64) AppleWebKit/537.36 (KHTML, like Gecko) Chrome/41.0.2272.101 Safari/537.36
- Origin: chrome-extension://hgml0ofddfdnphfgcellkdfbfjeloo
- Content-Type: application/json
- Accept: */*
- Accept-Encoding: gzip, deflate
- Accept-Language: en-US,en;q=0.8
- Cookie: JSESSIONID=6D607670BBCD51DE59CBFD6D91F9B163

Response headers

- Server: Apache-Coyote/1.1
- Content-Type: text/plain
- Content-Length: 53
- Date: Sun, 22 Mar 2015 22:43:48 GMT

Raw Parsed Response

Open output in new window Copy to clipboard Save as file Open in JSON tab

```

{"auth_token": "d4fdecf6-2e5a-4aed-8d60-f9a513b5c358"}

```

Code highlighting thanks to [Code Mirror](#)

Related information

[XenMobile Rest API](#)

XenMobile Mail Manager 10.x

Jun 19, 2017

XenMobile Mail Manager provides the functionality that extends the capabilities of XenMobile in the following ways:

- Dynamic Access Control for Exchange Active Sync (EAS) devices. EAS devices can be automatically allowed or blocked access to Exchange services.
- Provides the ability for XenMobile to access EAS device partnership information provided by Exchange.
- Provides the ability for XenMobile to perform an EAS Wipe on a mobile device.
- Provides the ability for XenMobile to access information about Blackberry devices, and to perform control operations such as Wipe and ResetPassword.

To download XenMobile Mail Manager, go to the Server Components section under XenMobile 10 Server on Citrix.com.

What's New in XenMobile Mail Manager 10.1

Access Rules

The Rule Analysis window has a check box which, when selected, displays only those rules which are conflicts, overrides, redundancies, or supplements.

Default access (Allow, Block, or Unchanged) and ActiveSync command modes (PowerShell or Simulation) are set separately for each Microsoft Exchange environment configured in your XenMobile deployment.

Snapshots

You can configure the maximum number of snapshots shown in the snapshot history.

You can configure which errors to ignore during a major snapshot. When a major snapshot returns errors that are not configured as ignorable, the results of the snapshots are discarded.

To configure errors as ignorable, edit the config.xml file using an XML editor:

- If the Exchange Server is Office 365, navigate to the `/ConfigRoot/EnvironmentBridge/AccessLayer/SpecialistsDefaults/PowerShells/PowerShell[@id='ExchangeOnline']/IgnorableErrors` node and add the text to be matched as a child element in the same format as the existing Error child element. Regular expressions are supported.
- If the Exchange Server is on-premises, navigate to the `/ConfigRoot/EnvironmentBridge/AccessLayer/SpecialistsDefaults/PowerShells/PowerShell[@id='ExchangeColocated']/IgnorableErrors` node and add the text to be matched as a child element in the same format as the existing Error child element. Regular expressions are supported.
- If there is more than one Exchange environment configured, navigate to the `/ConfigRoot/EnvironmentBridge/AccessLayer/Environments/Environment[@id='ID Corresponding to the desired Exchange environment']/ExchangeServer/Specialists/PowerShell` node. Add an IgnorableErrors child node to the PowerShell node for each error to be ignored. Add an Error child node to the IgnorableErrors node with the matching text contained in a CDATA section. Regular expressions are supported.

Save the config.xml and restart the XenMobile Mail Manager service.

PowerShell and Exchange

XenMobile Mail Manager now dynamically determines which cmdlets to use based on the version of Exchange it is connected to. For example, for Exchange 2010, it uses Get-ActiveSyncDevice, but for Exchange 2013 and Exchange 2016, it uses Get-MobileDevice.

Exchange Configuration

Exchange Server configurations can be edited and updated without restarting the XenMobile Mail Manager service.

Two new columns added to the Exchange environment summary tab display each environment's command mode (PowerShell or Simulation), and access mode (Allow, Block, or Unchanged).

Troubleshooting and Diagnostics

A set of PowerShell utilities for troubleshooting is available in the Support\PowerShell folder.

Testing connectivity to the Exchange service using the Test Connectivity button in the Configuration window of the console runs every read-only cmdlet used by the service, runs RBAC permissions tests against the Exchange Server for the configured user, and displays any errors or warnings in color-coded fashion (blue-yellow for warnings, red-orange for errors).

A new troubleshooting tool performs in-depth analysis of user mailboxes and devices, detecting error conditions and potential areas of failure, and in-depth RBAC analysis of users. It can save raw output of all cmdlets to a text file.

In support scenarios, all properties for all mailboxes on all devices managed by XenMobile Mail Manager can be saved by selecting a diagnostic check box in the console.

In support scenarios, trace-level logging is now supported.

Authentication

XenMobile Mail Manager supports Basic authentication for on-premises deployments. This enables XenMobile Mail Manager to be used when the XenMobile Mail Manager server is not a member of the domain in which the Exchange Server resides.

Fixed Issues

Access Rules

XenMobile Mail Manager applies local access control rules to all users in Active Directory (AD) groups, even if an AD group contains more than 1000 users. Previously, XenMobile Mail Manager applied local access control rules only to the first 1000 users of an AD group. [#548705]

The XenMobile Mail Manager console sometimes failed to respond when querying Active Directory groups containing 1000 users or more. [CXM-11729]

The LDAP Configuration window no longer displays an incorrect authentication mode. [CXM-5556]

Snapshots

User names with apostrophes no longer cause minor snapshots to fail. [#617549]

In support scenarios where pipelining is disabled (the Disable Pipelining option is selected in the Configuration window of the XenMobile Mail Manager console), major snapshots no longer fail in on-premises Exchange environments. [#586083]

In support scenarios where pipelining is disabled (the Disable Pipelining option is selected in the Configuration window of the XenMobile Mail Manager console), data for deep snapshots is no longer collected regardless of whether the environment was configured for deep or shallow snapshots. Now data for deep snapshots is collected only when the environment is configured for deep snapshots. [#586092]

The first major snapshot after initial installation occasionally encountered an error that prevented XenMobile Mail Manager from running another major snapshot until the XenMobile Mail Manager service was restarted. This no longer occurs. [CXM-5536]

Architecture

Jun 19, 2017

The following diagram shows the main components of XenMobile Mail Manager. For a detailed reference architecture diagram, see the XenMobile Deployment Handbook article, [Reference Architecture for On-Premises Deployments](#).

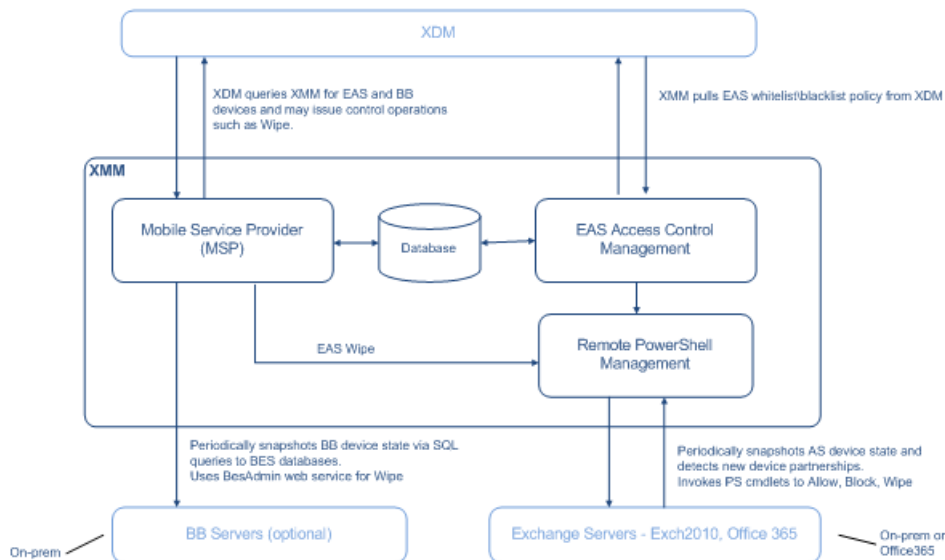

The three main components are:

- **Exchange ActiveSync Access Control Management.** Communicates with XenMobile to retrieve an Exchange ActiveSync policy from XenMobile, and merges this policy with any locally defined policy to determine the Exchange ActiveSync devices that should be allowed or denied access to Exchange. Local policy allows extending the policy rules to allow access control by Active Directory Group, User, Device Type, or Device User Agent (generally the mobile platform version).
- **Remote PowerShell Management.** Responsible for scheduling and invoking remote PowerShell commands to enact the policy compiled by Exchange ActiveSync Access Control Management. Periodically takes a snapshot of the Exchange ActiveSync database to detect new or changed Exchange ActiveSync devices.
- **Mobile Service Provider.** Provides a web service interface so that XenMobile can query Exchange ActiveSync and/or Blackberry devices, as well as issue control operations such as Wipe against them.

System requirements and prerequisites

Jun 19, 2017

The following minimum system requirements are required to use XenMobile Mail Manager:

- Windows Server 2012 R2, Windows Server 2008 R2 (must be an English-based server)
- Microsoft SQL Server 2016, SQL Server 2012, SQL Server 2012 Express LocalDB, or SQL Server Express 2008
- Microsoft .NET Framework 4.5
- Blackberry Enterprise Service, version 5 (optional)

Minimum supported versions of Microsoft Exchange Server

- Microsoft Office 365
- Exchange Server 2016
- Exchange Server 2013
- Exchange Server 2010 SP2

Device email clients

Not all email clients consistently return the same ActiveSync ID for a device. Because XenMobile Mail Manager expects a unique ActiveSync ID for each device, only email clients that consistently generate the same, unique ActiveSync ID for each device are supported. These email clients have been tested by Citrix and performed without errors:

- HTC native email client
- Samsung native email client
- iOS native email client
- Touchdown for Smartphones

XenMobile Mail Manager Prerequisites

- Windows Management Framework must be installed.
 - PowerShell V5, V4, and V3
- The PowerShell execution policy must be set to RemoteSigned via Set-ExecutionPolicy RemoteSigned.
- TCP port 80 must be open between the computer running XenMobile Mail Manager and the remote Exchange Server.

Requirements for on-premises computer running Exchange

Permissions. The credentials specified in the Exchange Configuration UI must be able to connect to the Exchange Server and be given full access to execute the following Exchange-specific PowerShell cmdlets.

- **For Exchange Server 2010 SP2:**
 - Get-CASMailbox
 - Set-CASMailbox
 - Get-Mailbox
 - Get-ActiveSyncDevice
 - Get-ActiveSyncDeviceStatistics
 - Clear-ActiveSyncDevice
 - Get-ExchangeServer
 - Get-ManagementRole
 - Get-ManagementRoleAssignment
- **For Exchange Server 2013 and Exchange Server 2016:**
 - Get-CASMailbox

- Set-CASMailbox
 - Get-Mailbox
 - Get-MobileDevice
 - Get-MobileDeviceStatistics
 - Clear-MobileDevice
 - Get-ExchangeServer
 - Get-ManagementRole
 - Get-ManagementRoleAssignment
- If XenMobile Mail Manager is configured to view the entire forest, permission must have been granted to run: `Set-AdServerSettings -ViewEntireForest $true`
 - The supplied credentials must have been granted the right to connect to the Exchange Server via the remote Shell. By default, the user who installed Exchange has this right.
 - Per the Microsoft TechNet article, [about_Remote_Requirements](#), in order to establish a remote connection and run remote commands, the credentials must correspond to a user who is an administrator on the remote machine. Per this blog post, [You Don't Have to Be An Administrator to Run Remote PowerShell Commands](#), `Set-PSSessionConfiguration` can be used to eliminate the administrative requirement, but the support and discussion of the particulars of this command are beyond the scope of this document.
 - The Exchange Server must be configured to support remote PowerShell requests via HTTP. Typically, an administrator running the following PowerShell command on the Exchange Server is all that is required: `WinRM QuickConfig`.
 - Exchange has many throttling policies. One of the policies controls how many concurrent PowerShell connections are allowed per user. The default number of simultaneous connections allowed for a user is 18 on Exchange 2010. When the connection limit is reached, XenMobile Mail Manager is not able to connect to Exchange Server. There are ways to change the maximum allowed simultaneous connections via PowerShell that are beyond the scope of this documentation. If interested, investigate Exchange throttling policies as related to remote management with PowerShell.

Requirements for Office 365 Exchange

- **Permissions.** The credentials specified in the Exchange Configuration UI must be able to connect to Office 365 and be given full access to execute the following Exchange-specific PowerShell cmdlets:
 - Get-CASMailbox
 - Set-CASMailbox
 - Get-Mailbox
 - Get-MobileDevice
 - Get-MobileDeviceStatistics
 - Clear-MobileDevice
 - Get-ExchangeServer
 - Get-ManagementRole
 - Get-ManagementRoleAssignment
- **Privileges.** The supplied credentials must have been granted the right to connect to the Office 365 server via the remote Shell. By default, Office 365 online administrator has the requisite privileges.
- **Throttling policies.** Exchange has many throttling policies. One of the policies controls how many concurrent PowerShell connections are allowed per user. The default number of simultaneous connections allowed for a user is three on Office 365. When the connection limit is reached, XenMobile Mail Manager is not able to connect to Exchange Server. There are ways to change the maximum allowed simultaneous connections via PowerShell that are beyond the scope of this documentation. If interested, investigate Exchange throttling policies as related to remote management with PowerShell.

Install and configure

Jun 19, 2017

1. Click the XmmSetup.msi file and then follow the prompts in the installer to install XenMobile Mail Manager.

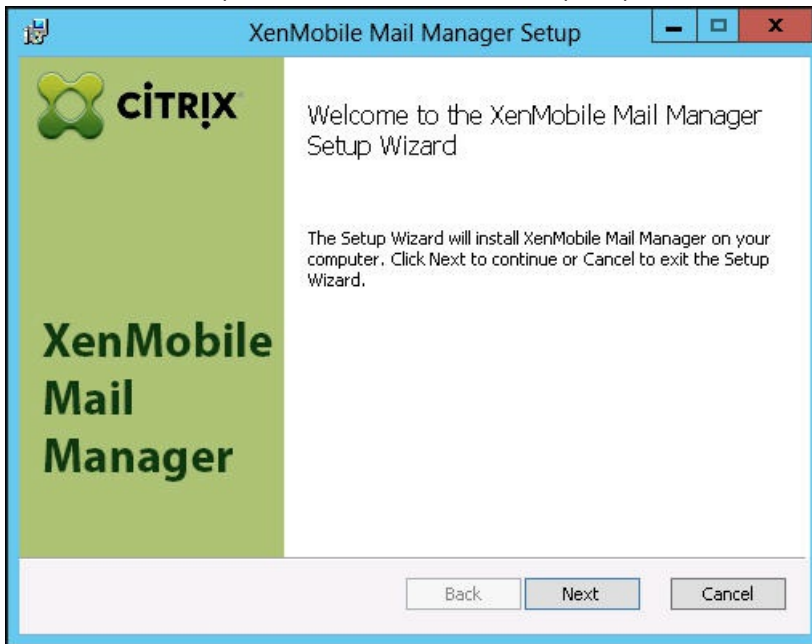

2. Leave **Launch the Configure utility** selected in the last screen of the set-up wizard. Or, from the **Start** menu, open **XenMobile Mail Manager**.

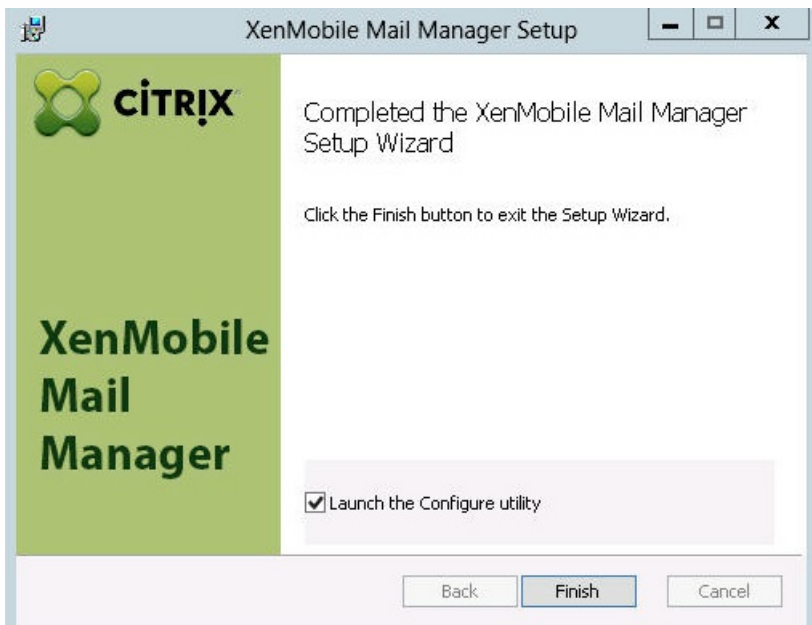

3. Configure the following database properties:
 1. Select the **Configure > Database** tab.
 2. Enter the name of the SQL Server (defaults to localhost).
 3. Keep the database as the default CitrixXmm.
 4. Select one of the following authentication modes used for SQL:
 - **Sql**. Enter the user name and password of a valid SQL user.

- **Windows Integrated.** If you select this option, the logon credentials of the XenMobile Mail Manager Service must be changed to a Windows account that has permissions to access the SQL Server. To do this, open **Control Panel > Administrative Tools > Services**, right-click the XenMobile Mail Manager Service entry and then click the **Log On** tab.

Note: If Windows Integrated is also chosen for the BlackBerry database connection, the Windows account specified here must also be given access to the BlackBerry database.

5. Click **Test Connectivity** to check that a connection can be made to the SQL Server and then click **Save**.

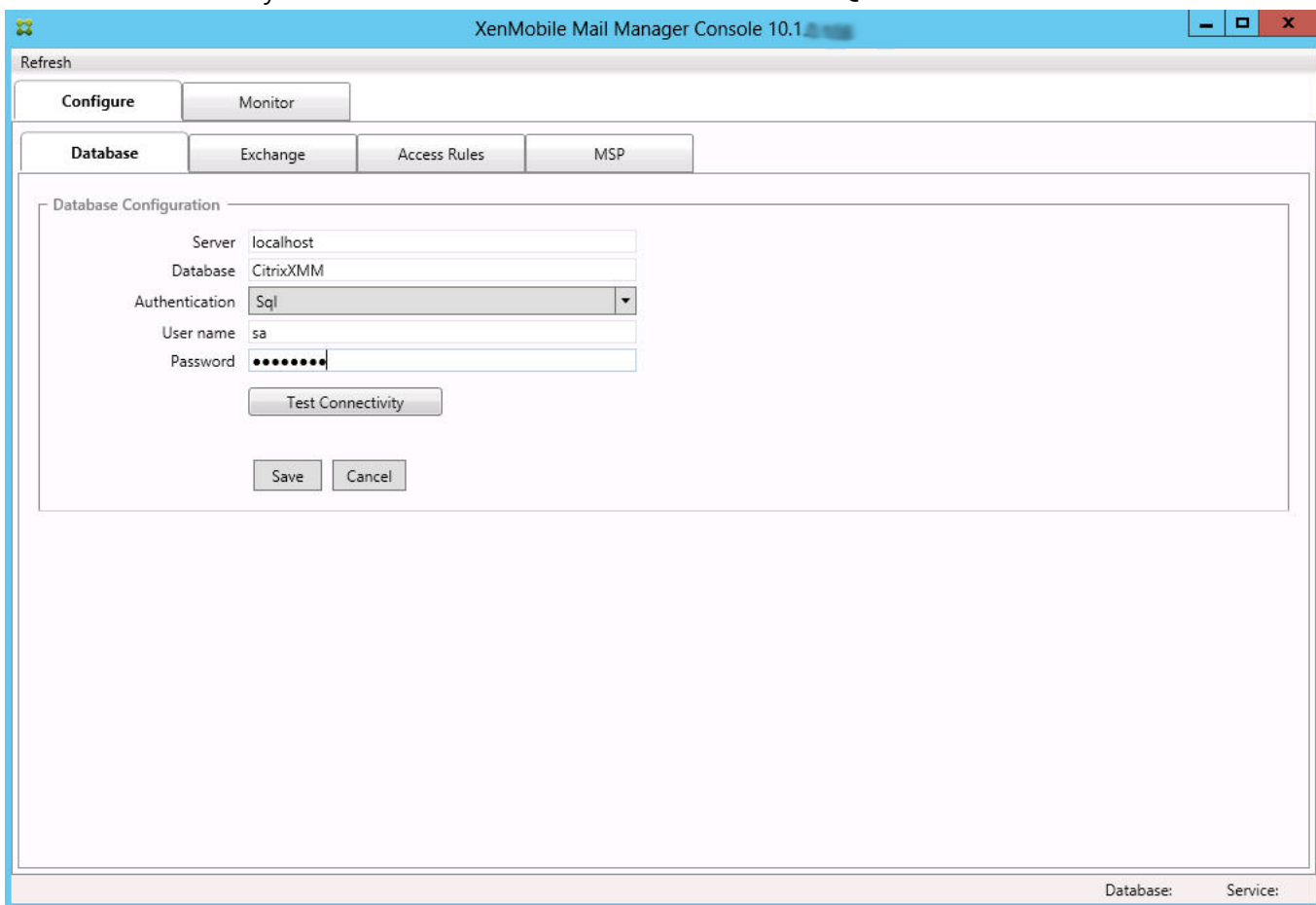

4. A message prompts you to restart the service. Click **Yes**.

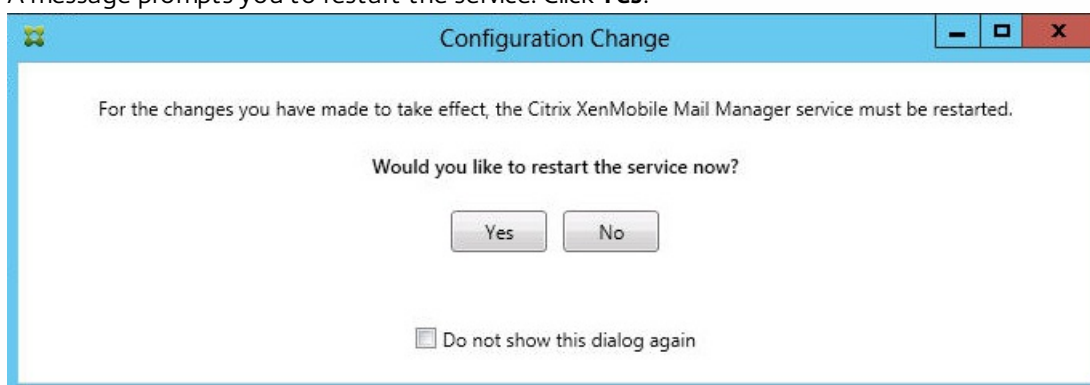

5. Configure one or more Exchange Servers:
 1. If managing a single Exchange environment, you only need a single server specified. If managing multiple Exchange environments, you need a single Exchange Server specified for each Exchange environment.
 2. Select the **Configure > Exchange** tab.

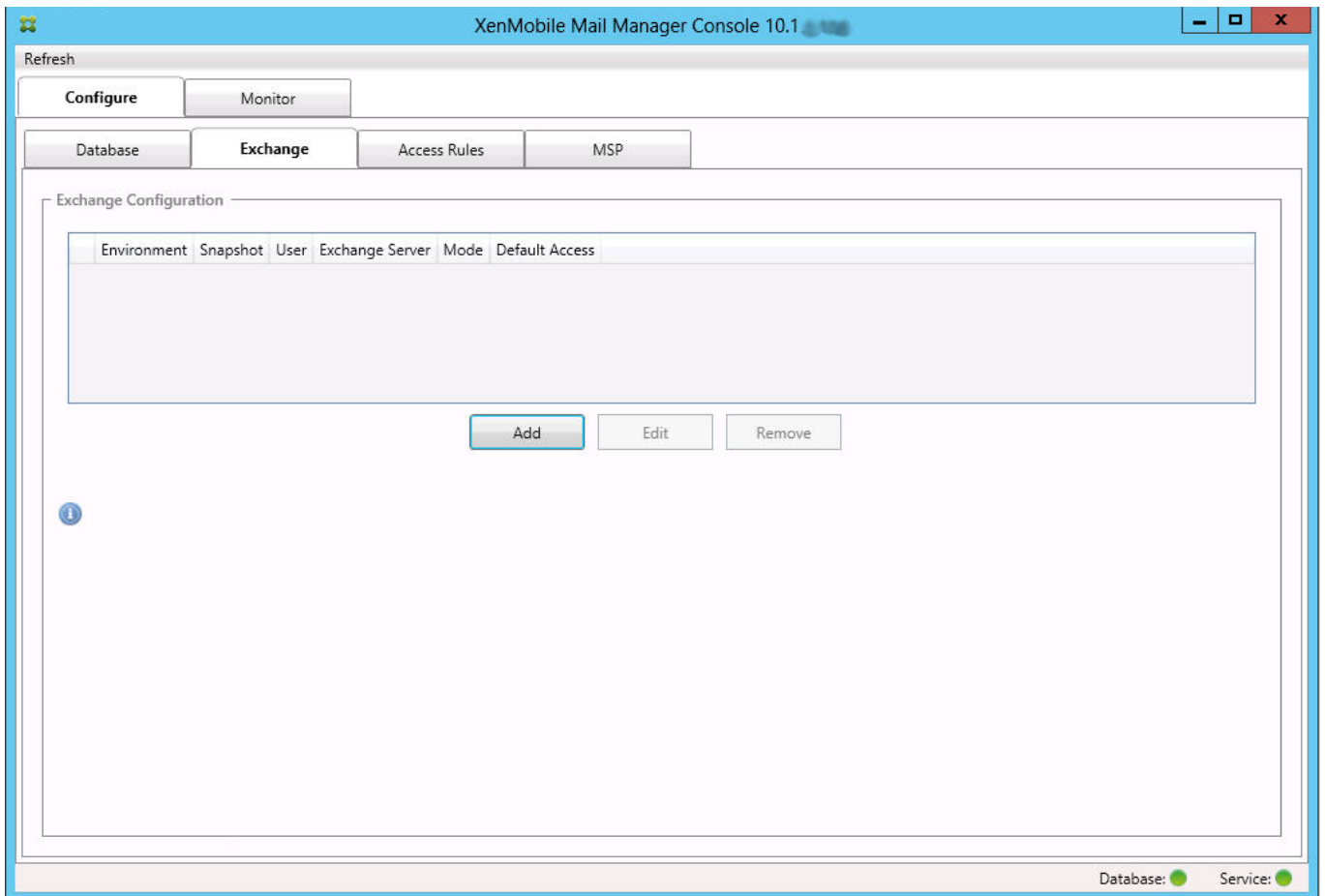

3. Click **Add**.
4. Select the type of Exchange Server environment: **On Premise** or **Office 365**.

5. If you select **On Premise**, enter the name of the Exchange Server that will be used for Remote PowerShell commands.
6. Enter the user name of a Windows identity that has appropriate rights on the Exchange Server as specified within the Requirements section.
7. Enter the **Password** for the user.
8. Select the schedule for running Major snapshots. A major snapshot detects every Exchange ActiveSync partnership.
9. Select the schedule for running Minor snapshots. A minor snapshot detects newly created Exchange ActiveSync partnerships.
10. Select the Snapshot Type: **Deep** or **Shallow**. Shallow snapshots are typically much faster and are sufficient to perform all the Exchange ActiveSync Access Control functions of XenMobile Mail Manager. Deep snapshots may take significantly longer and are only needed if the Mobile Service Provider is enabled for ActiveSync; this allows XenMobile to query for unmanaged devices.
11. Select the Default Access: **Allow**, **Block**, or **Unchanged**. This controls how all devices other than those identified by explicit XenMobile or Local rules are treated. If you select Allow, ActiveSync access to all such devices will be allowed; if you select Block, access will be denied; if you select Unchanged, no change will be made.
12. Select the ActiveSync Command Mode: **PowerShell** or **Simulation**.
 - In PowerShell mode, XenMobile Mail Manager will issue PowerShell commands to enact the desired access control.
 - In Simulation mode, XenMobile Mail Manager will not issue PowerShell commands, but will log the intended command and intended outcomes to the database. In Simulation mode, the user can then use the Monitor tab to see what would have happened if PowerShell mode was enabled.
13. Select **View Entire Forest** to configure XenMobile Mail Manager to view the entire Active Directory forest in the Exchange environment.
14. Select the authentication protocol: **Kerberos** or **Basic**. XenMobile Mail Manager supports Basic authentication for on-premises deployments. This enables XenMobile Mail Manager to be used when the XenMobile Mail Manager server is

not a member of the domain in which the Exchange server resides.

15. Click **Test Connectivity** to check that a connection can be made to the Exchange Server and then click **Save**.
 16. A message prompts you to restart the service. Click **Yes**.
6. Configure the access rules:
1. Select the **Configure > Access Rules** tab.
 2. Click the **XDM Rules** tab.

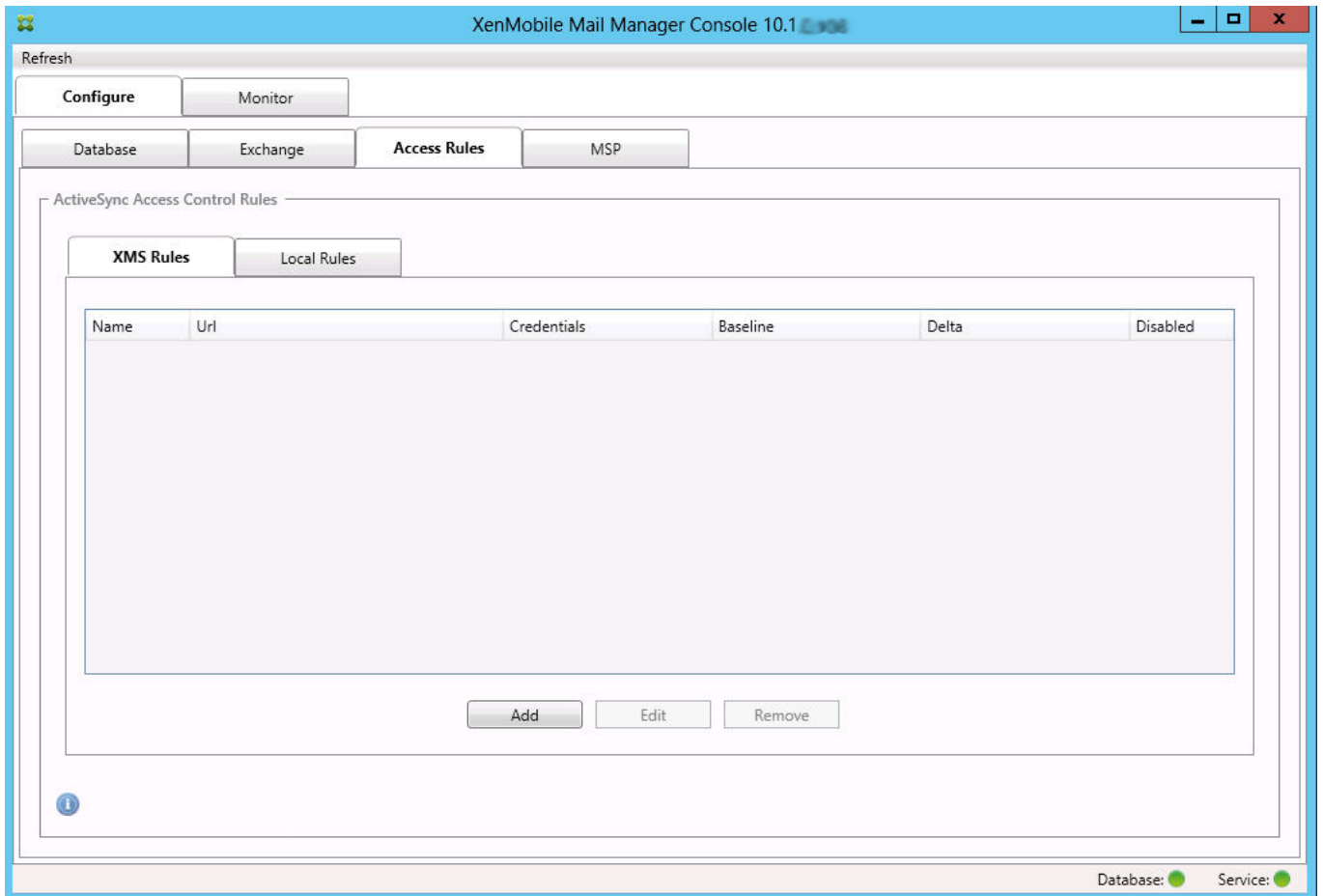

3. Click **Add**.

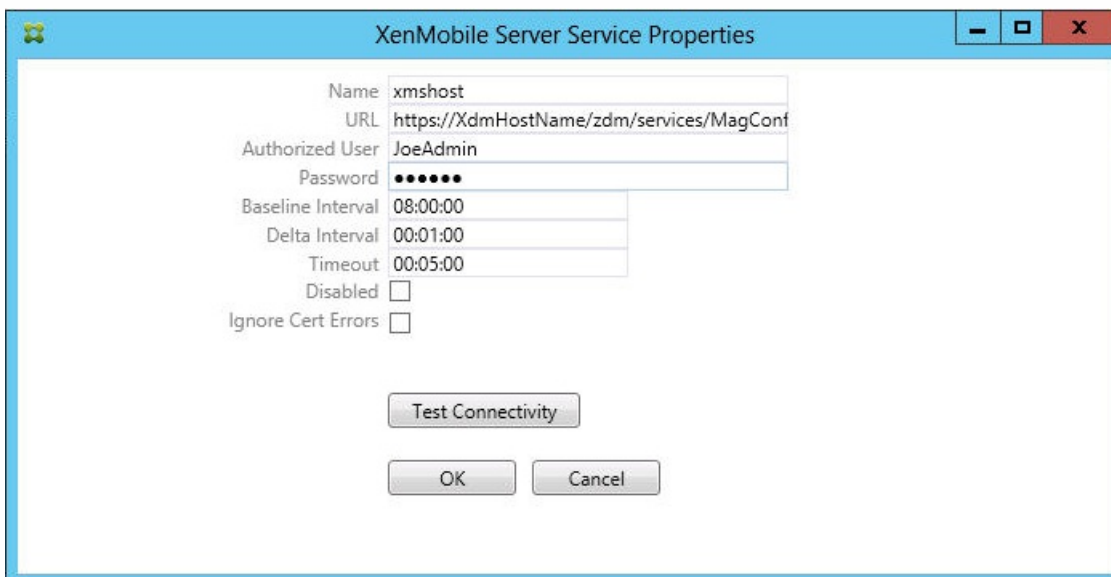

4. Enter a name for the XenMobile server rules, such as XdmHost.
 5. Modify the URL string to refer to the XenMobile server; for example, if the server name is XdmHost, enter `http://XdmHostName/zdm/services/MagConfigService`.
 6. Enter an authorized user on the server.
 7. Enter the password of the user.
 8. Keep the default values for the **Baseline Interval**, **Delta Interval**, and **Timeout values**.
 9. Click **Test Connectivity** to check the connection to the server.

Note: If the Disabled check box is checked, the XenMobile Mail Service will not collect policy from the XenMobile server.
 10. Click **OK**.
7. Click the **Local Rules** tab.
1. If you want to construct local rules that operate on Active Directory Groups, click **Configure LDAP** and then configure the LDAP connection properties.

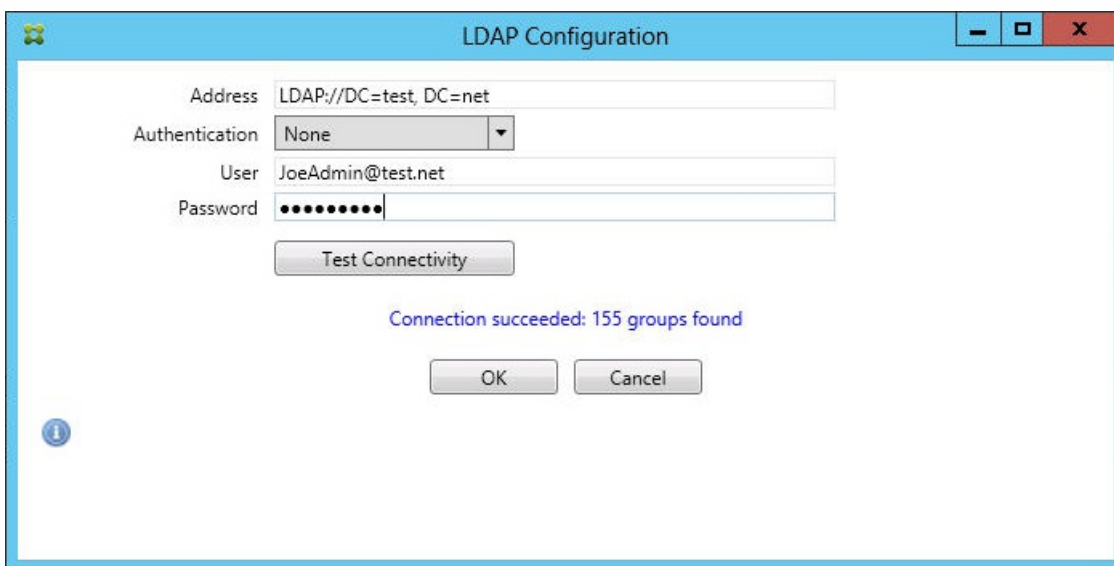

2. You can add local rules based on **ActiveSync Device ID**, **Device Type**, **AD Group**, **User**, or device **UserAgent**. In the list, select the appropriate type. For details, see [XenMobile Mail Manager Access Control Rules](#).
3. Enter text or text fragments in the text box. Optionally, click the query button to view the entities that match the fragment.

Note: For all types other than **Group**, the system relies on the devices that have been found in a snapshot. Therefore, if you are just starting and haven't completed a snapshot, no entities will be available.
4. Select a text value and then click **Allow** or **Deny** to add it to the **Rule List** pane on the right side. You can change the order of rules or remove them using the buttons to the right of the **Rule List** pane. The order is important because, for a given user and device, rules are evaluated in the order shown and a match on a higher rule (nearer the top) will cause subsequent rules to have no effect. For example, if you have a rule allowing all iPad devices and a subsequent rule blocking the user "Matt", Matt's iPad will still be allowed because the "iPad" rule has a higher effective priority than the "Matt" rule.
5. To perform an analysis of the rules within the rules list to find any potential overrides, conflicts, or supplemental constructs, click **Analyze**.
6. Click **Save**.
8. Configure the Mobile Service Provider.

Note: The Mobile Service Provider is optional and is necessary only if XenMobile is also configured to use the Mobile

Service Provider interface to query unmanaged devices.

1. Select the **Configure > MSP** tab.

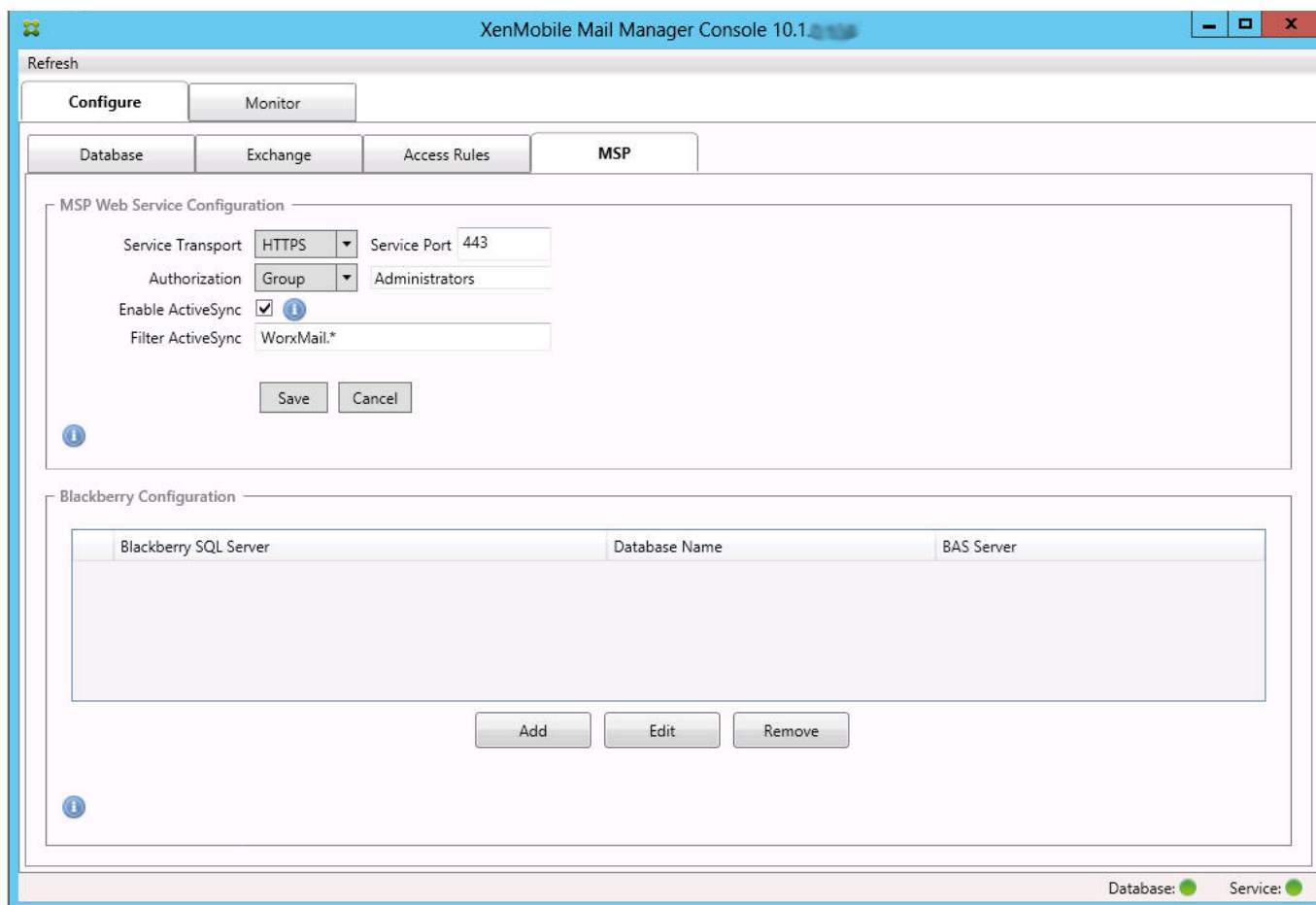

2. Set the Service Transport type as **HTTP** or **HTTPS** for the Mobile Service Provider service.
3. Set the Service port (typically 80 or 443) for the Mobile Service Provider service.
Note: If you use port 443, the port requires an SSL certificate bound to it in IIS.
4. Set the Authorization Group or User. This sets the user or set of users who will be able to connect to the Mobile Service Provider service from XenMobile.
5. Set whether ActiveSync queries are enabled or not.
Note: if ActiveSync queries are enabled for the XenMobile server, the Snapshot type for one or more Exchange Servers must be set to **Deep**; this may have significant performance costs for taking snapshots.
6. By default, ActiveSync devices that match the regular expression Secure Mail.* will not be sent to XenMobile. To change this behavior, alter the **Filter ActiveSync** field as necessary
Note: Blank means that all devices will be forwarded to XenMobile.
7. Click **Save**.
9. Optionally, configure one or more BlackBerry Enterprise Server (BES):
 1. Click **Add**.
 2. Enter the server name of the BES SQL Server.

BES Properties

BES Sql Server

Server: BesServer

Database: BesMgmt

Authentication: Sql

User name: JoeAdmin

Password: ●●●●●●

Test Connectivity

Sync Schedule: Every 30 Minutes

Blackberry Device Administration from XMS

Enabled:

BAS Server: BAServer

BAS Port: 443

Domain\User: ServerName\JoeAdmin

Password: ●●●●●●

Test Connectivity

Save Cancel

3. Enter the database name of the BES management database.
4. Select the Authentication mode. If you select Windows Integrated authentication, the user account of the XenMobile Mail Manager service is the account that is used to connect to the BES SQL Server.
Note: If you also choose Windows Integrated for the XenMobile Mail Manager database connection, the Windows account specified here must also be given access to the XenMobile Mail Manager database.
5. If you select **SQL authentication**, enter the user name and password.
6. Set the **Sync Schedule**. This is the schedule used to connect to the BES SQL Server and checks for any device updates.
7. Click **Test Connectivity** to check connectivity to the SQL Server.
Note: If you select Windows Integrated, this test uses the current logged on user and not the XenMobile Mail Manager service user and therefore does not accurately test SQL authentication.
8. If you want to support remote Wipe and/or ResetPassword of BlackBerry devices from XenMobile, check the **Enabled** check box.
 1. Enter the BES fully qualified domain name (FQDN).
 2. Enter the BES port used for the admin web service.
 3. Enter the fully qualified user and password required by the BES service.
 4. Click **Test Connectivity** to test the connection to the BES.
 5. Click **Save**.

Enforce email policies with ActiveSync IDs

Jun 19, 2017

Your corporate email policy may dictate that certain devices are not approved for corporate email use. To comply with this policy, you want to ensure that employees cannot access corporate email from such devices. XenMobile Mail Manager and XenMobile work together to enforce such an email policy. XenMobile sets the policy for corporate email access and, when an unapproved device enrolls with XenMobile, XenMobile Mail Manager enforces the policy.

The email client on a device advertises itself to Exchange Server (or Office 365) using the device ID, also known as the ActiveSync ID, which is used to uniquely identify the device. Secure Hub obtains a similar identifier and sends the identifier to XenMobile when the device is enrolled. By comparing the two device IDs, XenMobile Mail Manager can determine whether a specific device should have corporate email access. The following figure illustrates this concept:

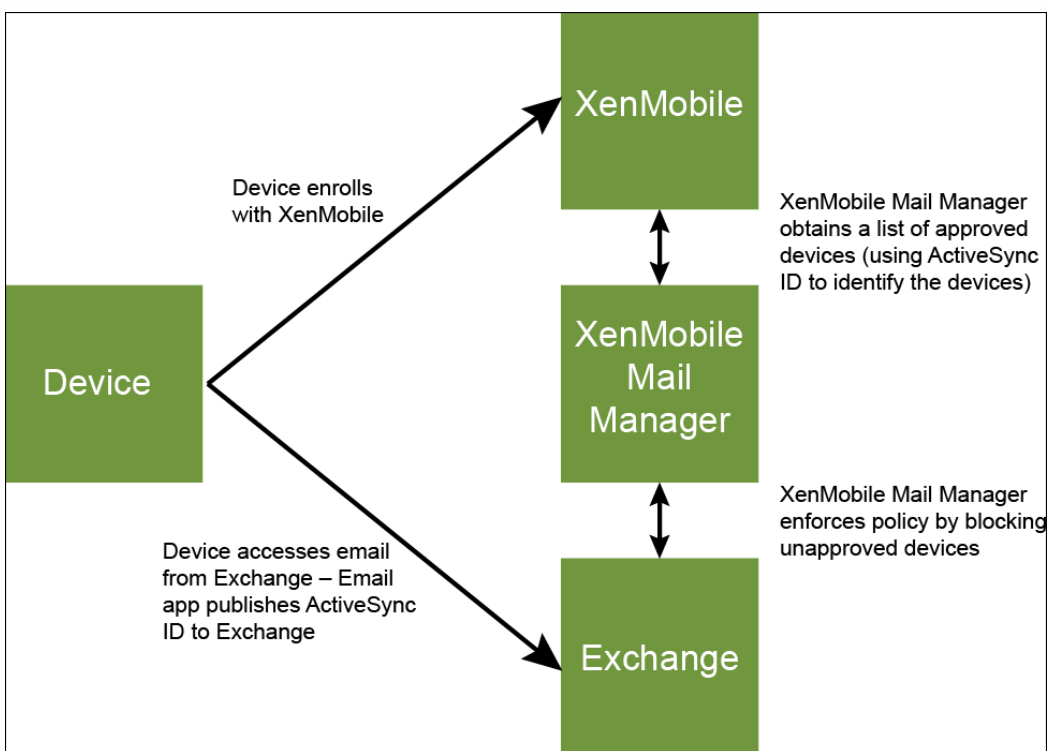

If XenMobile sends XenMobile Mail Manager an ActiveSync ID that is different from the ID the device publishes to Exchange, XenMobile Mail Manager cannot indicate to Exchange what to do with the device.

Matching ActiveSync IDs works reliably on most platforms; however, Citrix has found that on some Android implementations, the ActiveSync ID from the device is different from the ID that the mail client advertises to Exchange. To mitigate this problem, you can do the following:

- On the Samsung SAFE platform, push the device ActiveSync configuration from XenMobile.
- On all other Android platforms, push both the Touchdown app and the Touchdown ActiveSync configuration from XenMobile.

This does not, however, prevent an employee from installing an email client other than Touchdown on an Android device. To guarantee that your corporate email access policy is enforced properly, you can adopt a defensive security stance and

configure XenMobile Mail Manager to block emails by setting the static policy to Deny by default. This means that if an employee does configure an email client on an Android device other than Touchdown, and if ActiveSync ID detection does not work properly, the employee is denied corporate email access.

Access control rules

Jun 19, 2017

XenMobile Mail Manager provides a rule-based approach for dynamically configuring access control for Exchange ActiveSync devices. A XenMobile Mail Manager access control rule consists of two parts: a matching expression and a desired access state (Allow or Block). A rule may be evaluated against a given Exchange ActiveSync device to determine if the rule applies to, or matches the device. There are multiple kinds of matching expressions; for example, a rule may match all devices of a given Device Type, or a specific Exchange ActiveSync device ID, or all devices of a specific user, and so on. At any point during the adding, removing, and rearranging of the rules in the rule list, clicking the **Cancel** button will revert the rules list back to the state at which it was when first opened. Unless you click **Save**, any changes made to this window are lost if you close the Configure tool.

XenMobile Mail Manager has three types of rules: local rules, XenMobile server rules (also known as XDM rules), and the default access rule.

Local rules. Local rules have the highest priority: If a device is matched by a local rule, rule evaluation stops. Neither XenMobile server rules nor the default access rule will be consulted. Local rules are configured locally to XenMobile Mail Manager via the Configure>Access Rules>Local Rules tab. Support matching is based upon a user's membership within a given Active Directory group. Support matching is based upon regular expressions for the following fields:

- Active Sync Device ID
- ActiveSync Device Type
- User Principal Name (UPN)
- ActiveSync User Agent (typically the device platform or email client)

As long as a major snapshot has completed and found devices, you should be able to add either a normal or regular expression rule. If a major snapshot has not completed, you can only add regular expression rules.

XenMobile server rules. XenMobile server rules are references to an external XenMobile server that provides rules about managed devices. The XenMobile server can be configured with its own high-level rules that identify the devices to be allowed or blocked based on properties known to XenMobile, such as whether the device is jailbroken or whether the device contains forbidden apps. XenMobile evaluates the high-level rules and produces a set of allowed or blocked ActiveSync Device IDs, which are then delivered to XenMobile Mail Manager.

Default access rule. The default access rule is unique in that it can potentially match every device and is always evaluated last. This rule is the catch-all rule, which means that if a given device does not match a local or XenMobile server rule, the desired access state of the device is determined by the desired access state of the default access rule.

- **Default Access – Allow.** Any device that is not matched by either a local or XenMobile server rule will be allowed.
- **Default Access – Block.** Any device that is not matched by either a local or XenMobile server rule will be blocked.
- **Default Access - Unchanged.** Any device that is not matched by either a local or XenMobile server rule will not have its access state modified in any way by XenMobile Mail Manager. If a device has been placed into Quarantine mode by Exchange, no action is taken; for example, the only way to remove a device from Quarantine mode is to have an explicitly Local or XDM rule override the quarantine.

About Rule Evaluations

For each device that Exchange reports to XenMobile Mail Manager, the rules are evaluated in sequence, from highest to lowest priority as follows:

- Local rules
- XenMobile server rules
- Default access rule

When a match is found, evaluation stops. For example, if a local rule matches a given device, the device will not be evaluated against any of the XenMobile server rules or the default access rule. This holds true within a given rule type as well. For example, if there's more than a single match for a given device in the local rule list, as soon as the first match is encountered, evaluation stops.

XenMobile Mail Manager reevaluates the currently defined set of rules when device properties change, or when devices are added or removed, or when the rules themselves change. Major snapshots pick up device property changes and removals at configurable intervals. Minor Snapshots pick up new devices at configurable intervals.

Exchange ActiveSync has rules governing access as well. It is important to understand how these rules work in the context of XenMobile Mail Manager. Exchange may be configured with three levels of rules: personal exemptions, device rules, and organization settings. XenMobile Mail Manager automates access control by programmatically issuing Remote PowerShell requests to affect the personal exemptions lists. These are lists of allowed or blocked Exchange ActiveSync device IDs associated with a given mailbox. When deployed, XenMobile Mail Manager effectively takes over management of the exemption lists capability within Exchange. For details, see this [Microsoft article](#).

Analyzing is particularly useful in situations in which multiple rules for the same field have been defined. You can troubleshoot the relationships between rules. You perform analysis from the perspective of rule fields; for example, rules are analyzed in groups based upon the field that is being matched, such as ActiveSync device ID, ActiveSync device type, User, User Agent, and so on.

Rule terminology:

- **Overriding rule.** An override occurs when more than a single rule could apply to the same device. Because rules are evaluated by priority in the list, the later rule instance(s) which might apply might never be evaluated.
- **Conflicting rule.** A conflict occurs when more than a single rule could apply to the same device but the access (Allow/Block) does not match. If the conflicting rules are not regular expression rules, a conflict always implicitly connotes an override
- **Supplemental rule.** A supplement occurs when more than one rule is a regular expression rule and hence there might be a need to ensure that the two (or more) regular expressions can either be combined into a single regular expression rule, or are not duplicating functionality. A supplementary rule may also conflict in its access (Allow/Block).
- **Primary rule.** The primary rule is the rule that has been clicked within the dialog box. The rule is indicated visually by a solid border line that surrounds it. The rule will also have one or two green arrows pointing up or down. If an arrow points up, the arrow indicates that there are ancillary rules that precede the primary rule. If an arrow points down, this indicates that there are ancillary rules that come after the primary rule. Only a single primary rule can be active at any time.
- **Ancillary rule.** An ancillary rule is related in some way to the primary rule either through override, conflict, or a supplementary relationship. The rules are indicated visually by a dashed border that surrounds them. For each primary rule, there can be one to many ancillary rules. When clicking on any underlined entry, the ancillary rule or rules that are highlighted are always from the perspective of the primary rule. For example, the ancillary rule will be overridden by the primary rule, and/or the ancillary rule will conflict in its access with the primary rule, and/or the ancillary rule will supplement the primary rule.

The Appearance of the Types of Rules in the Rule Analysis Dialog Box

When there are no conflicts, overrides, or supplements, the Rule Analysis dialog box has no underlined entries. Clicking on

any of the items has no impact; for example, normal selected item visuals will occur.

The Rule Analysis window has a check box which, when selected, displays only those rules which are conflicts, overrides, redundancies, or supplements.

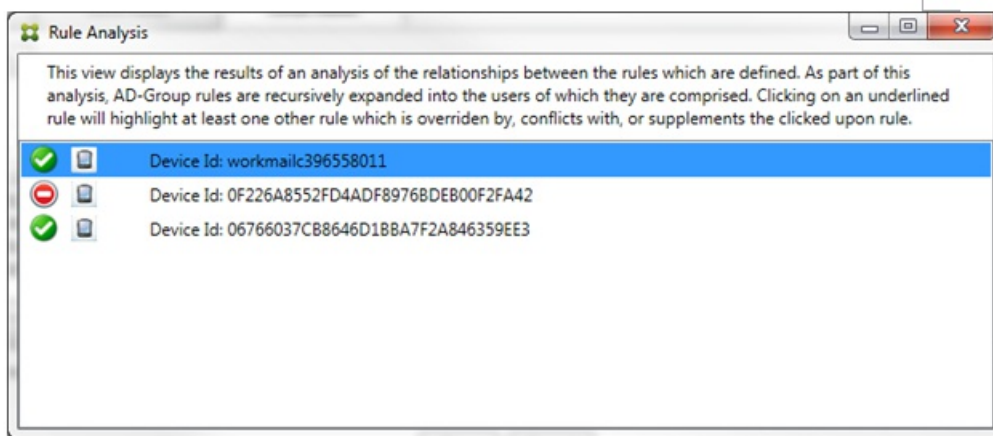

When an override occurs, at least two rules will be underlined: the primary rule and the ancillary rule or rules. At least one ancillary rule will appear in a lighter font to indicate that the rule has been overridden by a higher priority rule. You can click on the overridden rule to find out which rule or rules have overridden the rule. Any time an overridden rule has been highlighted either as a result of the rule being the primary or ancillary rule, a black circle will appear next to it as a further visual indication that the rule is inactive. For example, before clicking on the rule, the dialog box appears as follows:

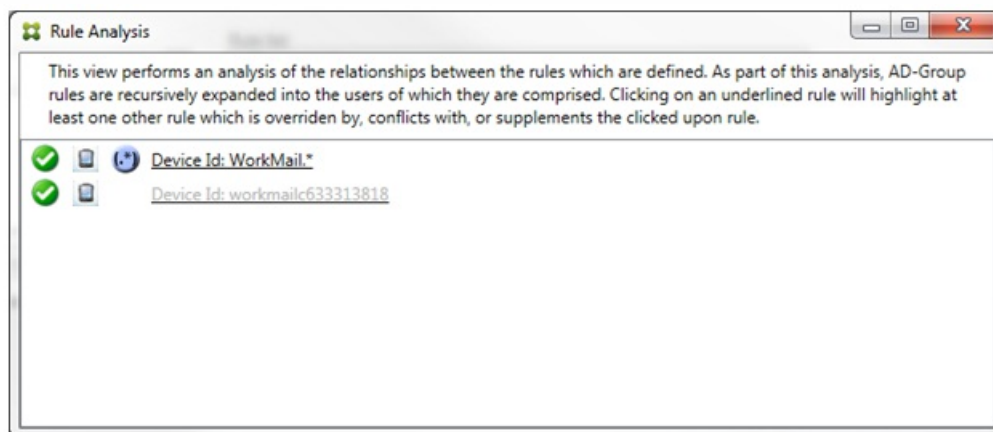

When you click the highest-priority rule, the dialog box appears as follows:

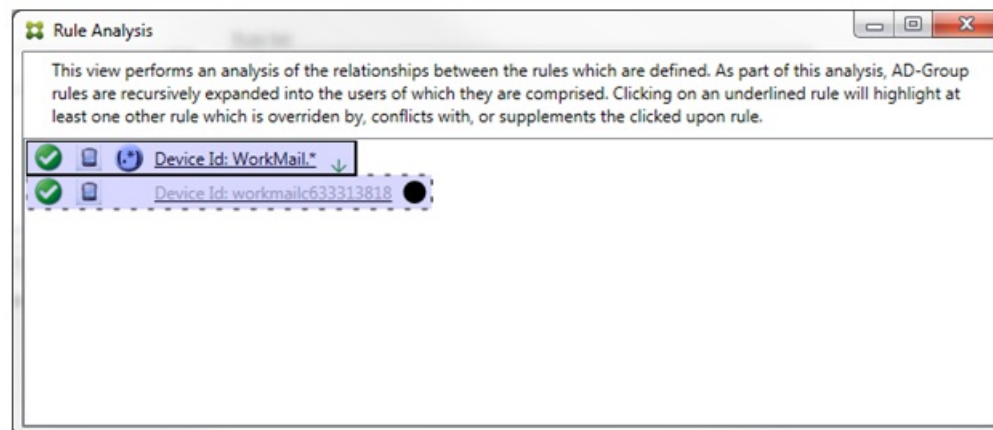

In this example, the regular expression rule WorkMail.* is the primary rule (indicated by the solid border) and the normal rule workmail633313818 is an ancillary rule (indicated by the dashed border). The black dot next to the ancillary rule is a visual cue that further indicates that the rule is inactive (will never be evaluated) due to the higher-priority regular expression rule that precedes it. After clicking on the overridden rule, the dialog box appears as follows:

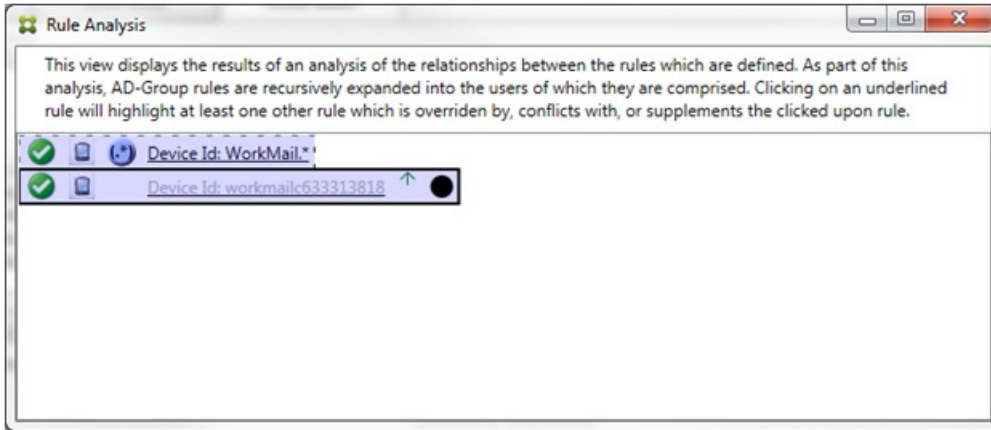

In the preceding example, the regular expression rule WorkMail.* is the ancillary rule (indicated by the dashed border) and the normal rule workmail633313818 is a primary rule (indicated by the solid border). For this simple example, there's not much difference. For a more complicated example, see the complex expression example later in this topic. In a scenario with many rules defined, clicking the overridden rule would quickly identify which rule or rules had overridden it.

When a conflict occurs, at least two rules will be underlined, the primary rule and the ancillary rule or rules. The rules in conflict are indicated by a red dot. Rules that only conflict with one another are only possible with two or more regular expression rules defined. In all other conflict scenarios, there will not only be a conflict, but an override at play. Prior to clicking on either of the rules in a simple example, the dialog box appears as follows:

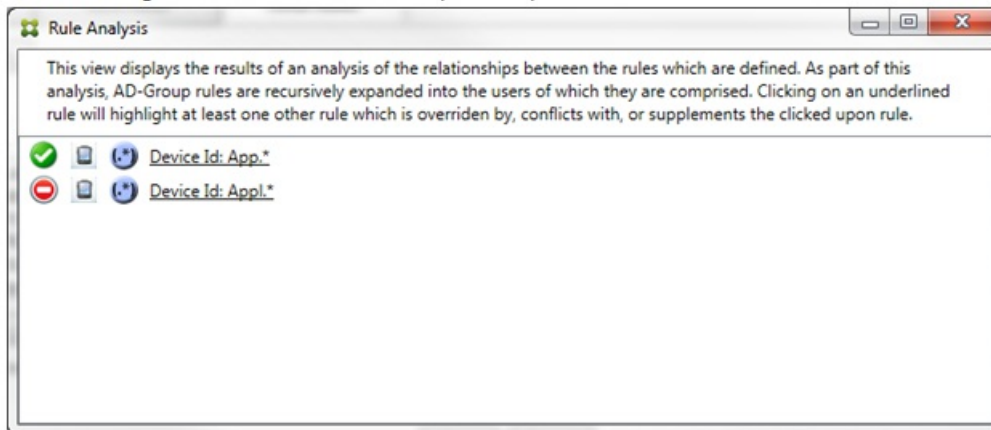

By inspecting the two regular expression rules, it's evident that the first rule allows all devices with a device ID that contains "App" and that the second rule denies all devices with a device ID that contains Appl. In addition, even though the second rule denies all devices with a device ID that contains Appl, no devices with that match criteria will ever be denied because of the higher precedence of the allow rule. After clicking on the first rule, the dialog box appears as follows:

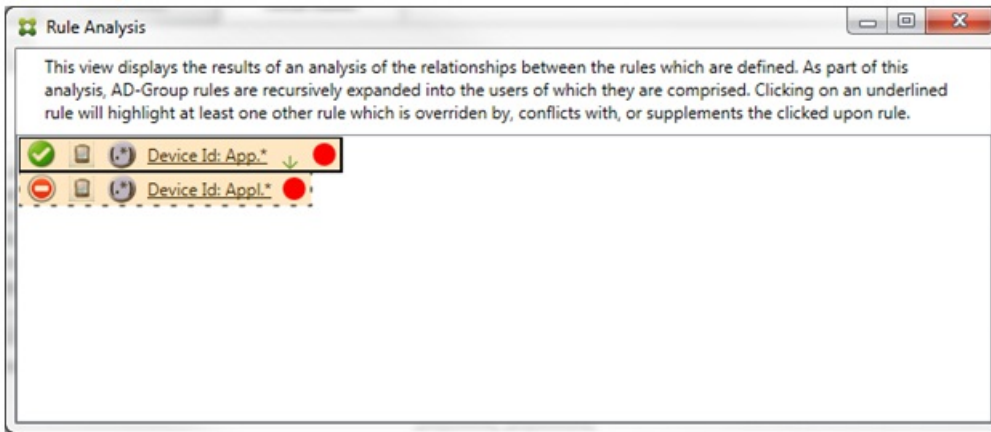

In the preceding scenario, both the primary rule (regular expression rule App.*) and the ancillary rule (regular expression rule Appl.*) are both highlighted in yellow. This is simply a visual warning to alert you to the fact that you have applied more than a single regular expression rule to a single matchable field, which could mean a redundancy issue or something more serious.

In a scenario with both a conflict and override, both the primary rule (regular expression rule App.*) and the ancillary rule (regular expression rule Appl.*) are highlighted in yellow. This is simply a visual warning to alert you to the fact that you have applied more than a single regular expression rule to a single matchable field, which could mean a redundancy issue or something more serious.

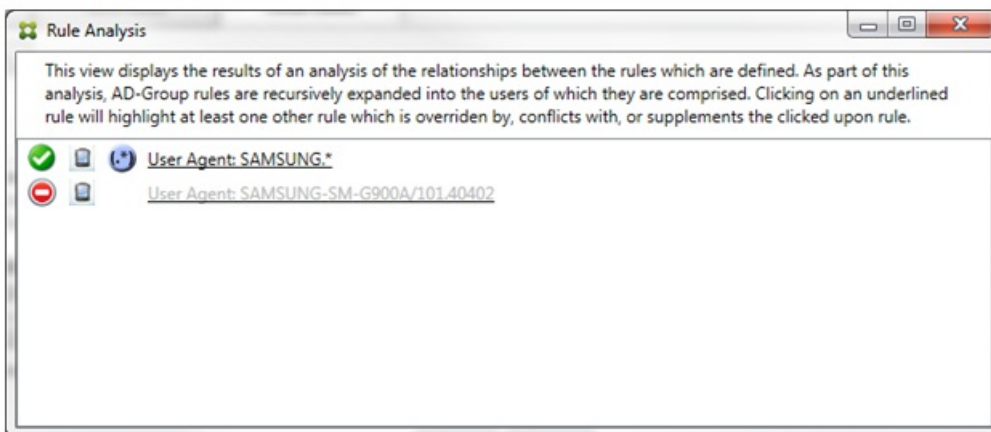

It is easy to see in the preceding example that the first rule (regular expression rule SAMSUNG.*) not only overrides the next rule (normal rule SAMSUNG-SM-G900A/101.40402), but that the two rules differ in their access (primary specifies Allow, ancillary specifies Block). The second rule (normal rule SAMSUNG-SM-G900A/101.40402) is displayed in lighter text to indicate that it has been overridden and is therefore inactive.

After clicking on the regular expression rule, the dialog box appears as follows:

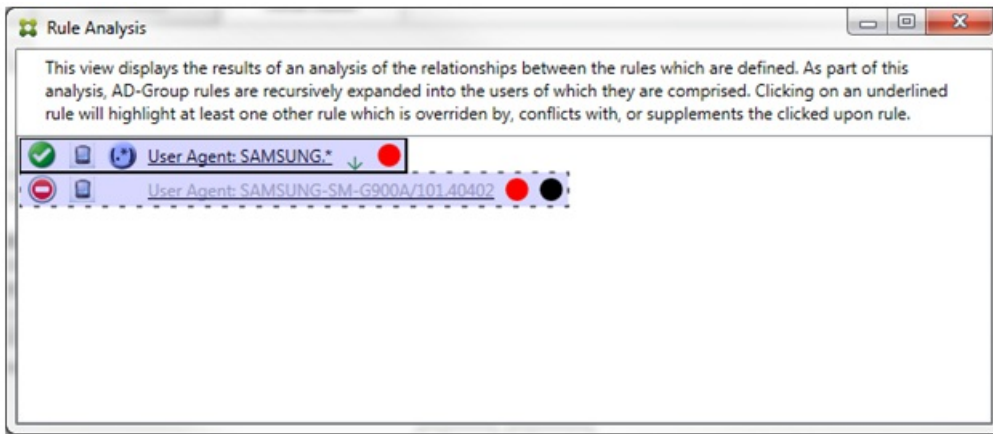

The primary rule (regular expression rule SAMSUNG.*) is followed by a red dot to indicate that its access state conflicts with one or more ancillary rules. The ancillary rule (normal rule SAMSUNG-SM-G900A/101.40402) is followed by a red dot to indicate that its access state conflicts with the primary rule, as well as with a black dot to further indicate that it has been overridden and is therefore inactive.

At least two rules will be underlined, the primary rule and the ancillary rule or rules. Rules that only supplement one another will only involve regular expression rules. When rules supplement one another they are indicated with a yellow overlay. Prior to clicking on either of the rules, in a simple example, the dialog box appears as follows:

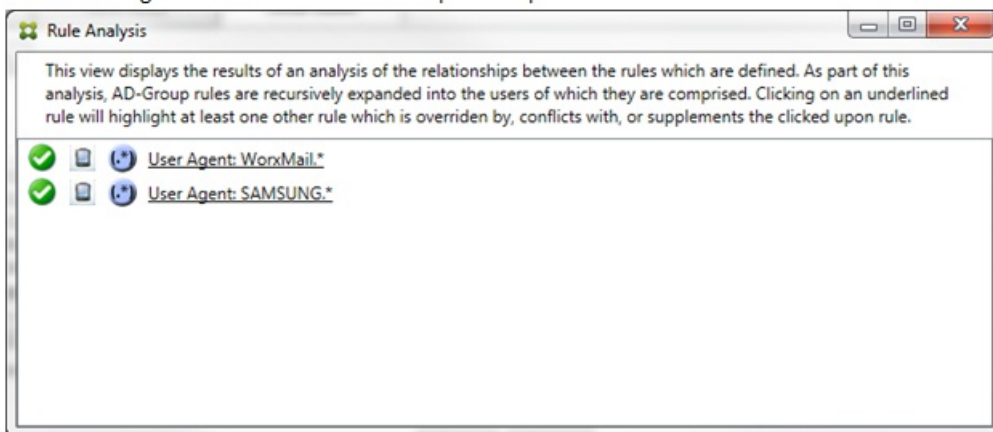

Visual inspection easily reveals that both rules are regular expression rules which have both been applied to the ActiveSync device ID field in XenMobile Mail Manager. After clicking on the first rule, the dialog box looks as follows:

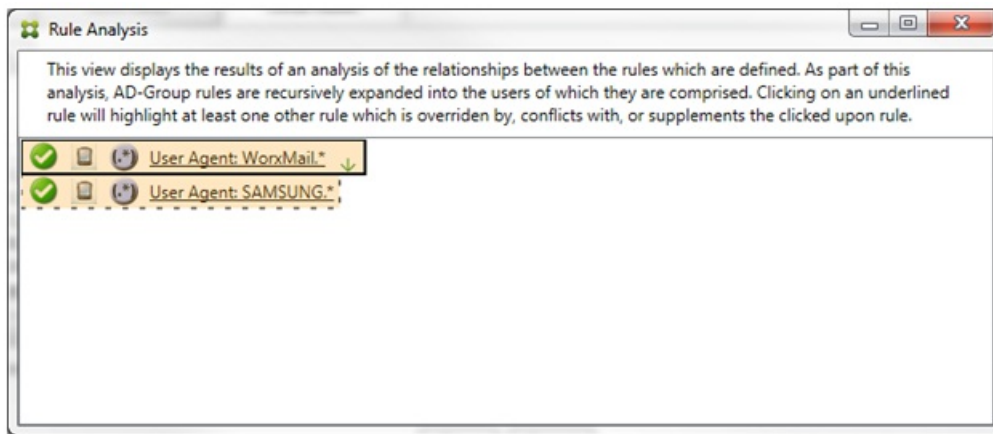

The primary rule (regular expression rule WorkMail.*) is highlighted with a yellow overlay to indicate that there exists at least one additional ancillary rule which is a regular expression. The ancillary rule (regular expression rule SAMSUNG.*) is highlighted with a yellow overlay to indicate that both it and the primary rule are regular expression rules being applied to the same field within XenMobile Mail Manager; in this case, the ActiveSync device ID field. The regular expressions may or may not overlap. It is up to you to decide if your regular expressions are properly crafted.

Example of a Complex Expression

Many potential overrides, conflicts, or supplements can occur, making it impossible to give an example of all possible scenarios. The following example discusses what not to do, while also serving to illustrate the full power of the rule analysis visual construct. Most of the items are underlined in the following figure. Many of the items render in a lighter font, which indicates that the rule in question has been overridden by a higher priority rule in some manner. A number of regular expression rules are included in the list as well, as indicated by the  icon.

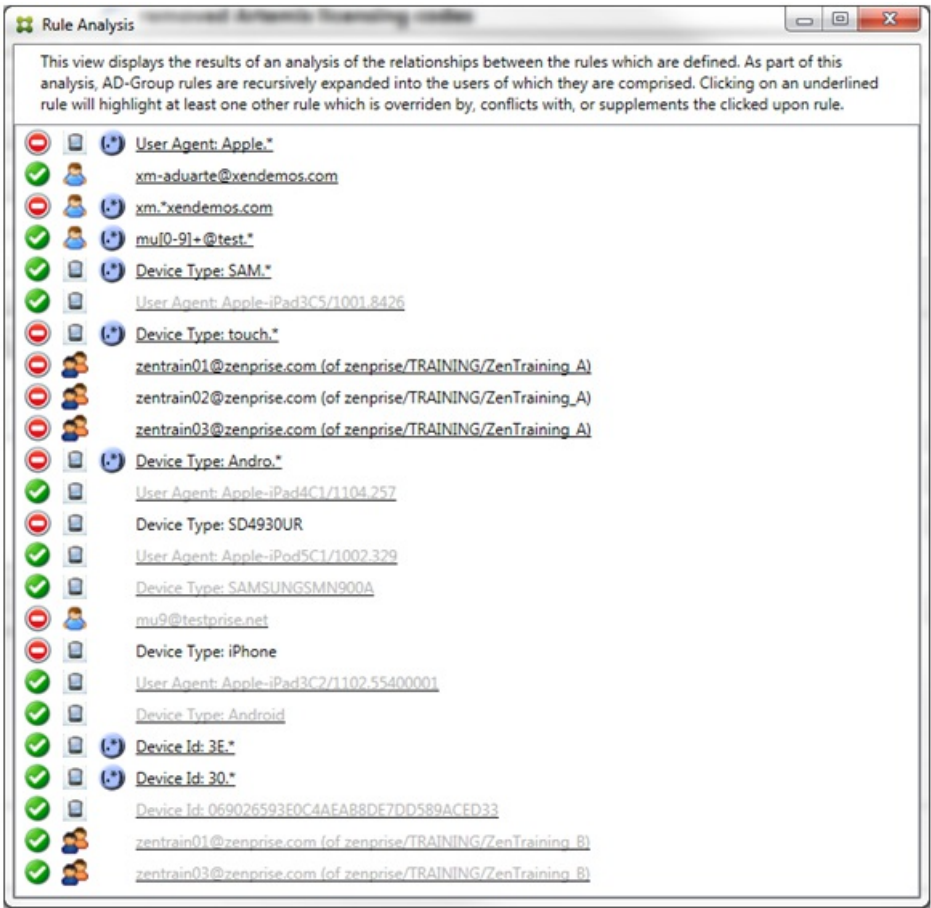

How to Analyze an Override

To see which rule or rules have overridden a particular rule, you click the rule.

Example 1: This example examines why zentrain01@zenprise.com has been overridden.

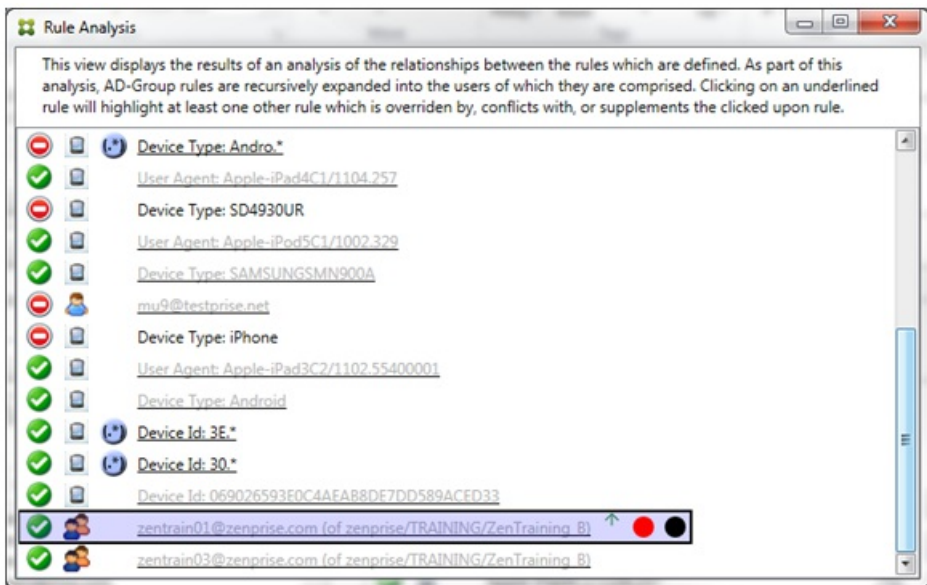

The primary rule (AD-Group rule zenprise/TRAINING/ZenTraining B, of which zentrain01@zenprise.com is a member) has the

following characteristics:

- Is highlighted in blue and has a solid border.
- Has an upwards pointing green arrow (to indicate that the ancillary rule or rules are all to be found above it).
- Is followed by both a red circle and black circle to indicate respectively that one or more ancillary rule conflicts with its access and that the primary rule has been overridden and is hence inactive.

When you scroll up, you see the following:

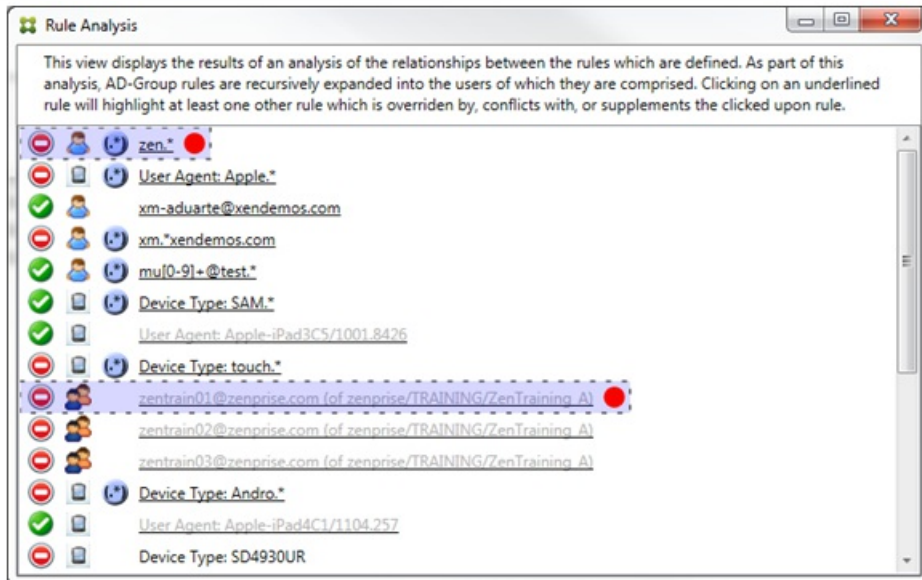

In this case, there are two ancillary rules that override the primary rule: the regular expression rule zen.* and the normal rule zentrain01@zenprise.com (of zenprise/TRAINING/ZenTraining A). In the case of the latter ancillary rule, what has occurred is that the Active Directory Group rule ZenTraining A contains the user zentrain01@zenprise.com, and the Active Directory Group rule ZenTraining B also contains the user zentrain01@zenprise.com. Because the ancillary rule has a higher precedence than the primary rule, however, the primary rule has been overridden. The primary rule's access is Allow, and because both of the ancillary rule's access is Block, all are followed with a red circle to further indicate an access conflict.

Example 2: This example shows why the device with an ActiveSync device ID of 069026593E0C4AEAB8DE7DD589ACED33 has been overridden:

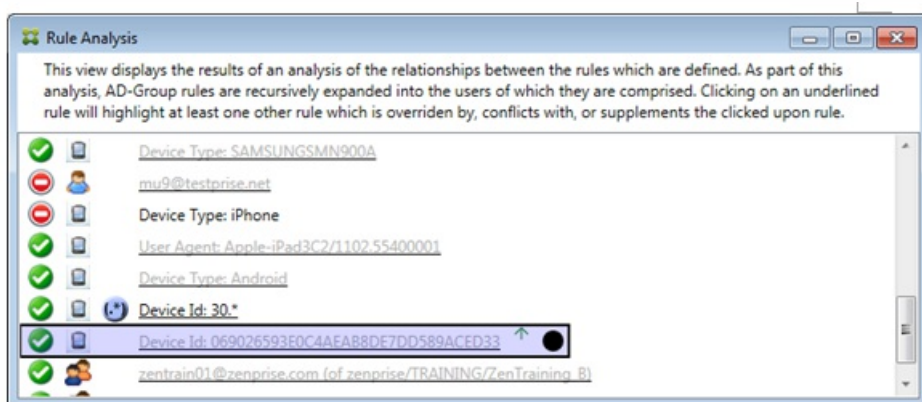

The primary rule (normal device ID rule 069026593E0C4AEAB8DE7DD589ACED33) has the following characteristics:

- Is highlighted in blue and has a solid border.
- Has an upwards pointing green arrow (to indicate that the ancillary rule is to be found above it).
- Is followed by a black circle to indicate an ancillary rule has overridden the primary rule and is hence inactive.

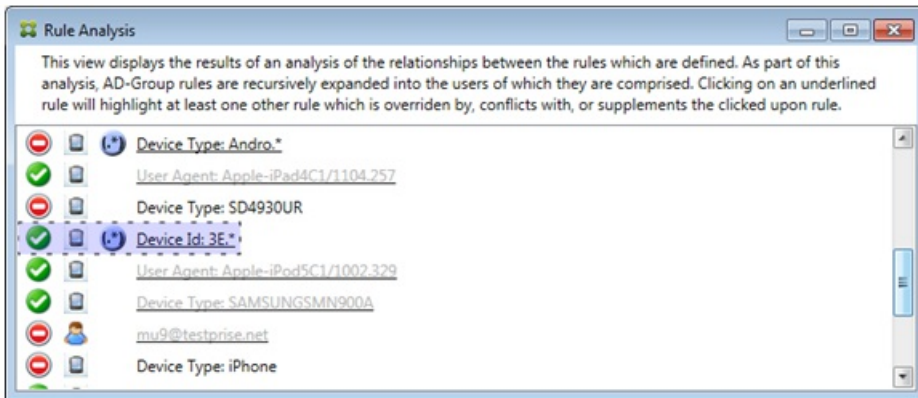

In this case, a single ancillary rule overrides the primary rule: the regular expression ActiveSync device ID rule 3E.* Because the regular expression 3E.* would match 069026593E0C4AEAB8DE7DD589ACED33, the primary rule will never be evaluated.

How to Analyze a Supplement and Conflict

In this case, the primary rule is the regular expression ActiveSync device type rule touch.* The characteristics are as follows:

- Is indicated by a solid border with a yellow overlay as a warning that there is more than a single regular expression rule operating against a particular rule field, in this case ActiveSync device type.
- Two arrows are pointing up and down respectively, indicating that there is at least one ancillary rule with higher priority and at least one ancillary rule with lower priority.
- The red circle next to it indicates that at least one ancillary rule has its access set to Allow which conflicts with the primary rule's access of Block
- There are two ancillary rules: the regular expression ActiveSync device type rule SAM.* and the regular expression ActiveSync device type rule Andro.*
- Both of the ancillary rules are bordered with dashes to indicate that they are ancillary.
- Both of the ancillary rules are overlaid with yellow to indicate that they are supplementally being applied to the rule field of ActiveSync device type.
- You should ensure in such scenarios that their regular expression rules are not redundant.

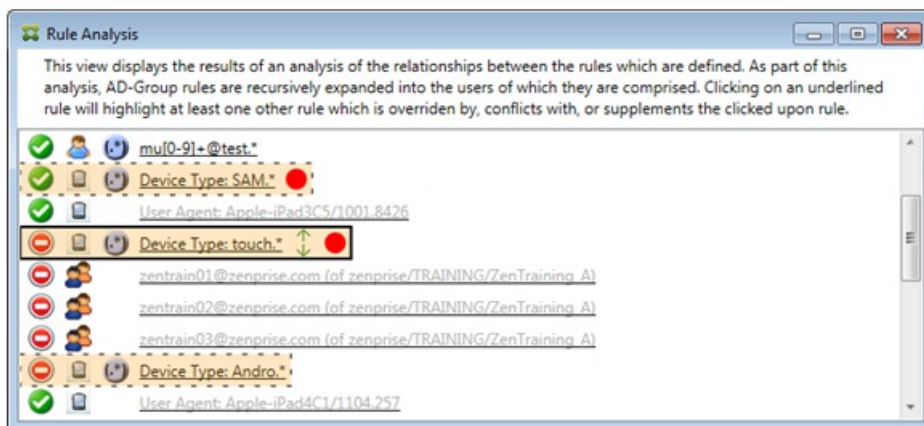

How to Further Analyze the Rules

This example explores how rule relationships are always from the perspective of the primary rule. The preceding example showed how a click on the regular expression rule applied to the rule field of device type with a value of touch.* Clicking on the ancillary rule Andro.* shows a different set of ancillary rules highlighted.

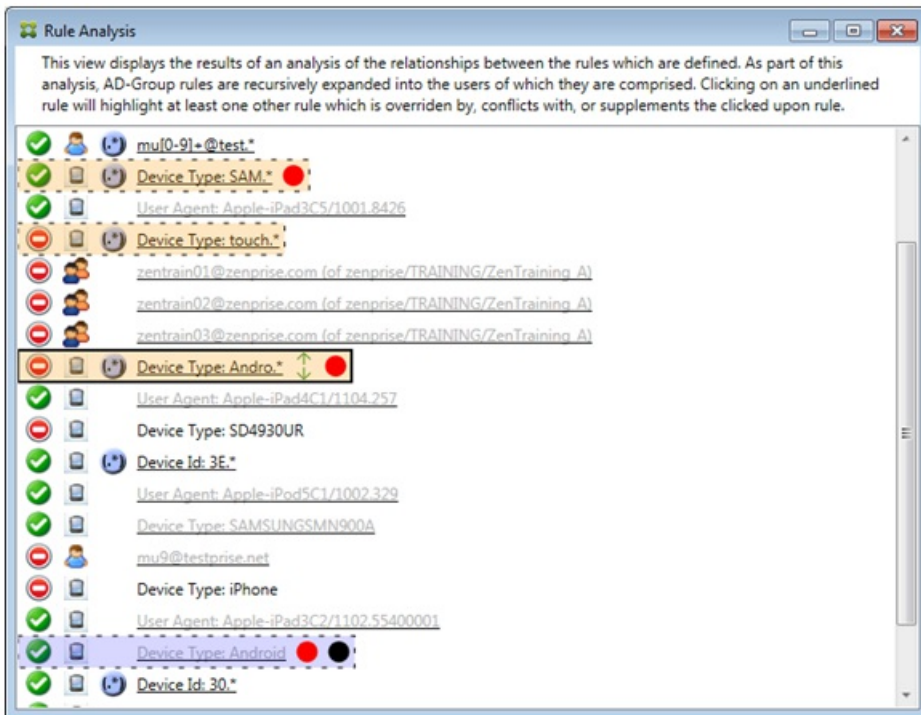

The example shows an overridden rule that is included in the rule relationship. This rule is the normal ActiveSync device type rule Android, which is overridden (indicated by the lightened font and the black circle next to it) and also conflicts in its access with the primary rule regular expression ActiveSync device type rule Andro.*; that rule was formerly an ancillary rule prior to being clicked. In the preceding example, the normal ActiveSync device type rule Android, was not displayed as an ancillary rule because, from the perspective of the then primary rule (the regular expression ActiveSync device type rule touch.*), it was not related to it.

To configure a normal expression local rule

1. Click the Access Rules tab.

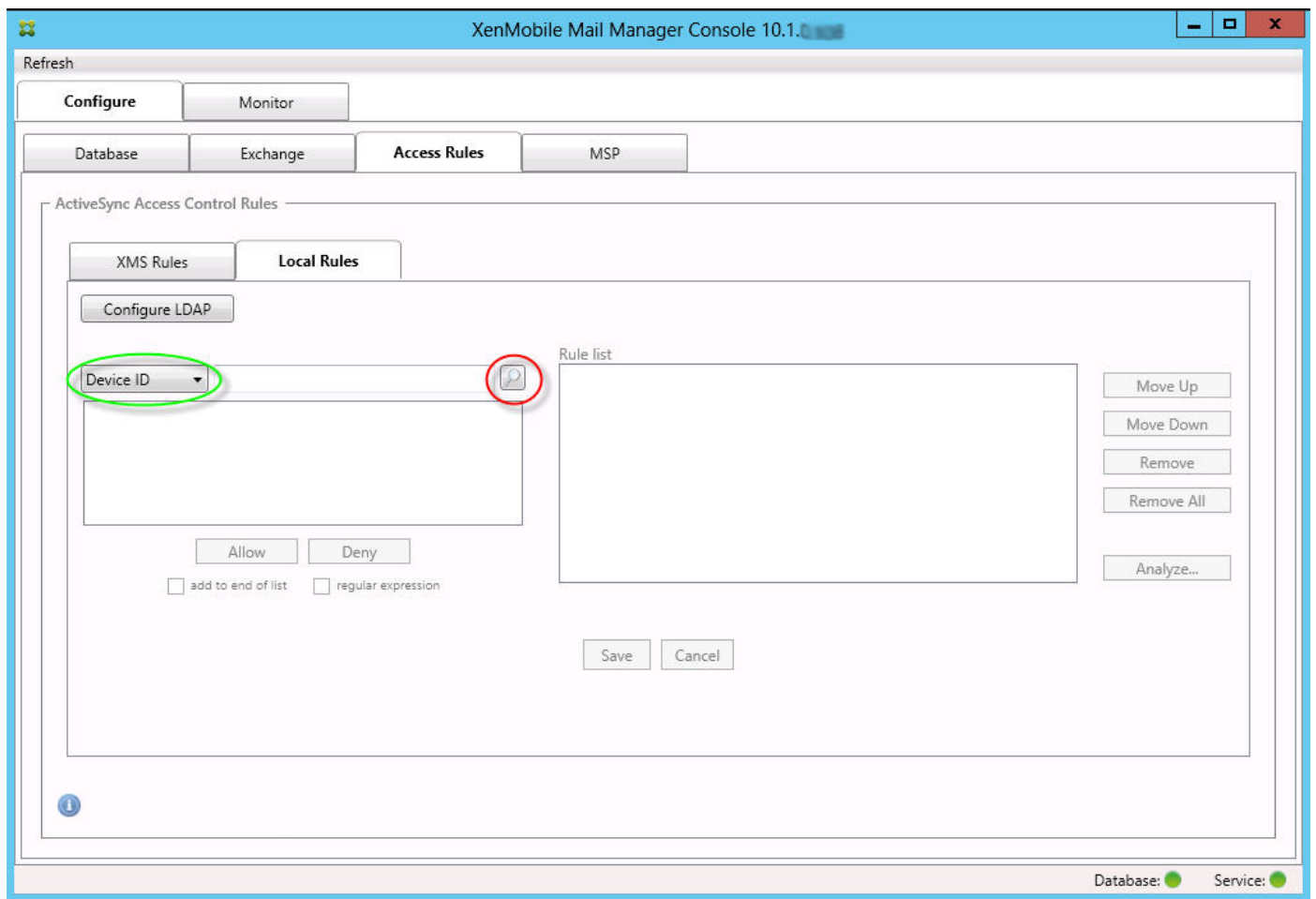

2. In the Device ID list, select the field for which you want to create a Local Rule.
3. Click on the magnifying glass icon to display all of the unique matches for the chosen field. In this example, the field Device Type has been chosen and the choices are shown below in the list box.

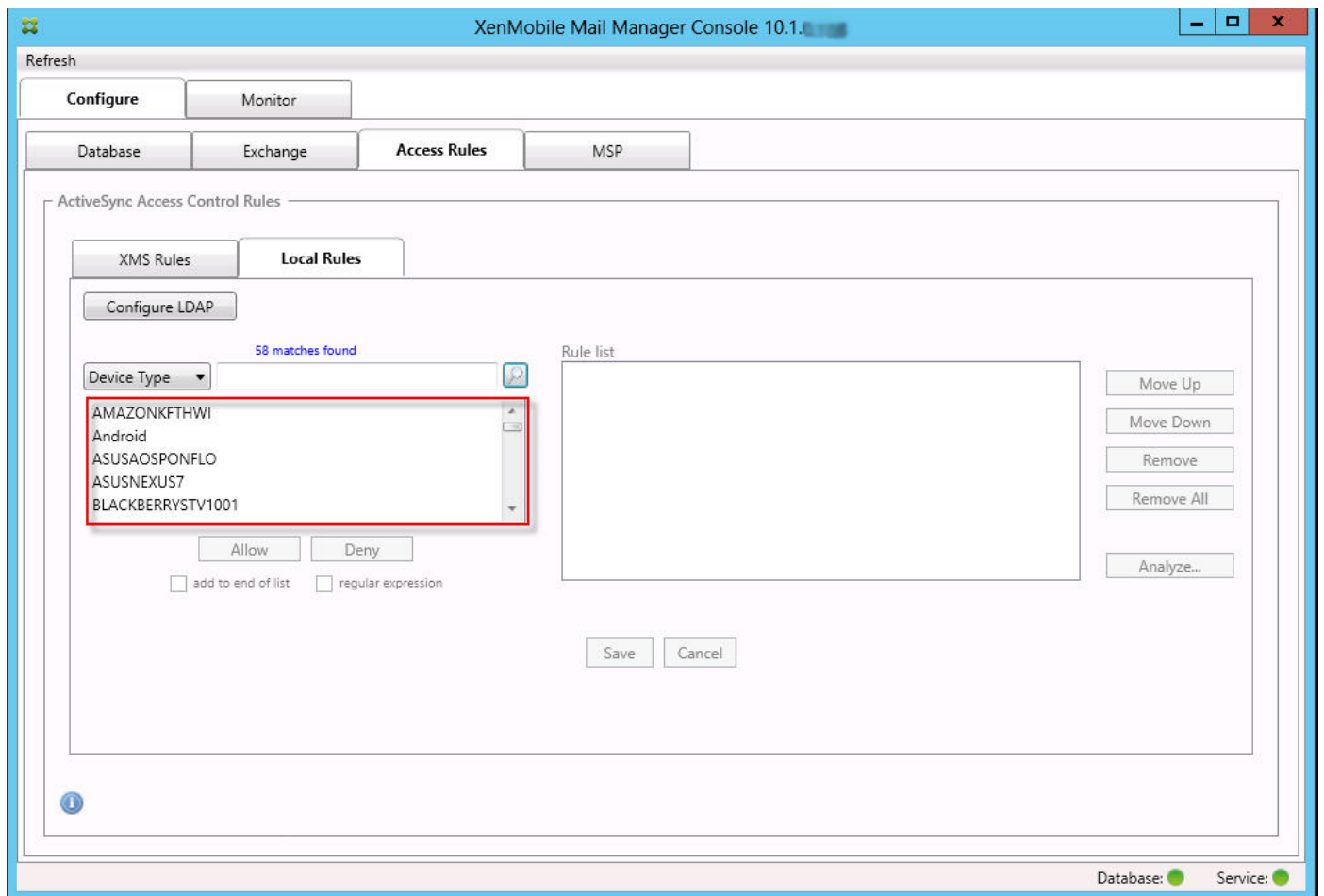

4. Click one of the items in the results list box and then click one of the following options:
- Allow means that Exchange will be configured to allow ActiveSync traffic for all matching devices.
 - Deny means that Exchange will be configured to deny ActiveSync traffic for all matching devices.
- In this example, all devices that have a device type of TouchDown are denied access.

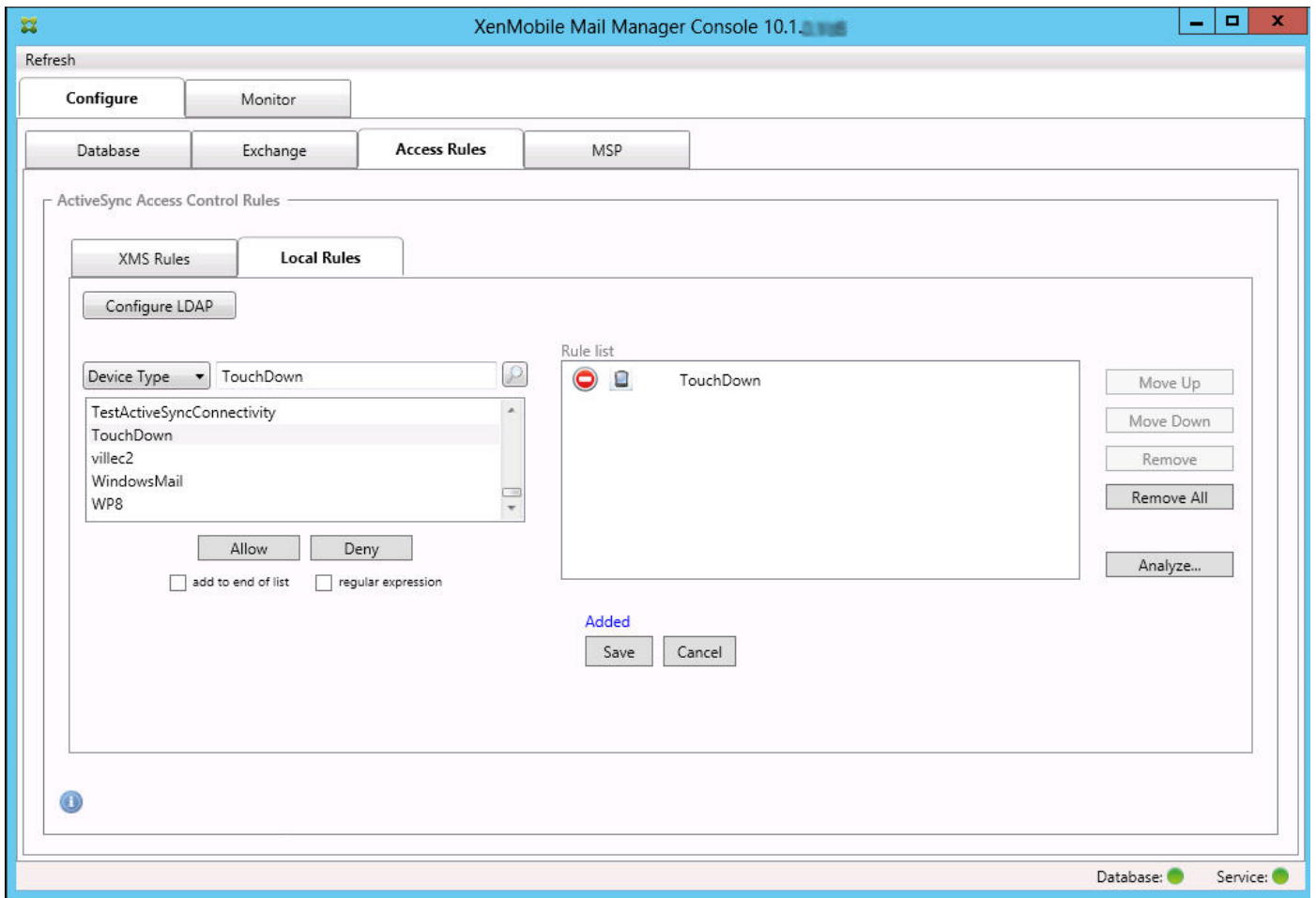

To add a regular expression

Regular expression local rules can be distinguished by the icon which appears next to them - . To add a regular expression rule, you can either build a regular expression rule from an existing value from the results list for a given field (as long as a major snapshot has completed), or you can simply type in the regular expression that you want.

To build a regular expression from an existing field value

1. Click the Access Rules tab.

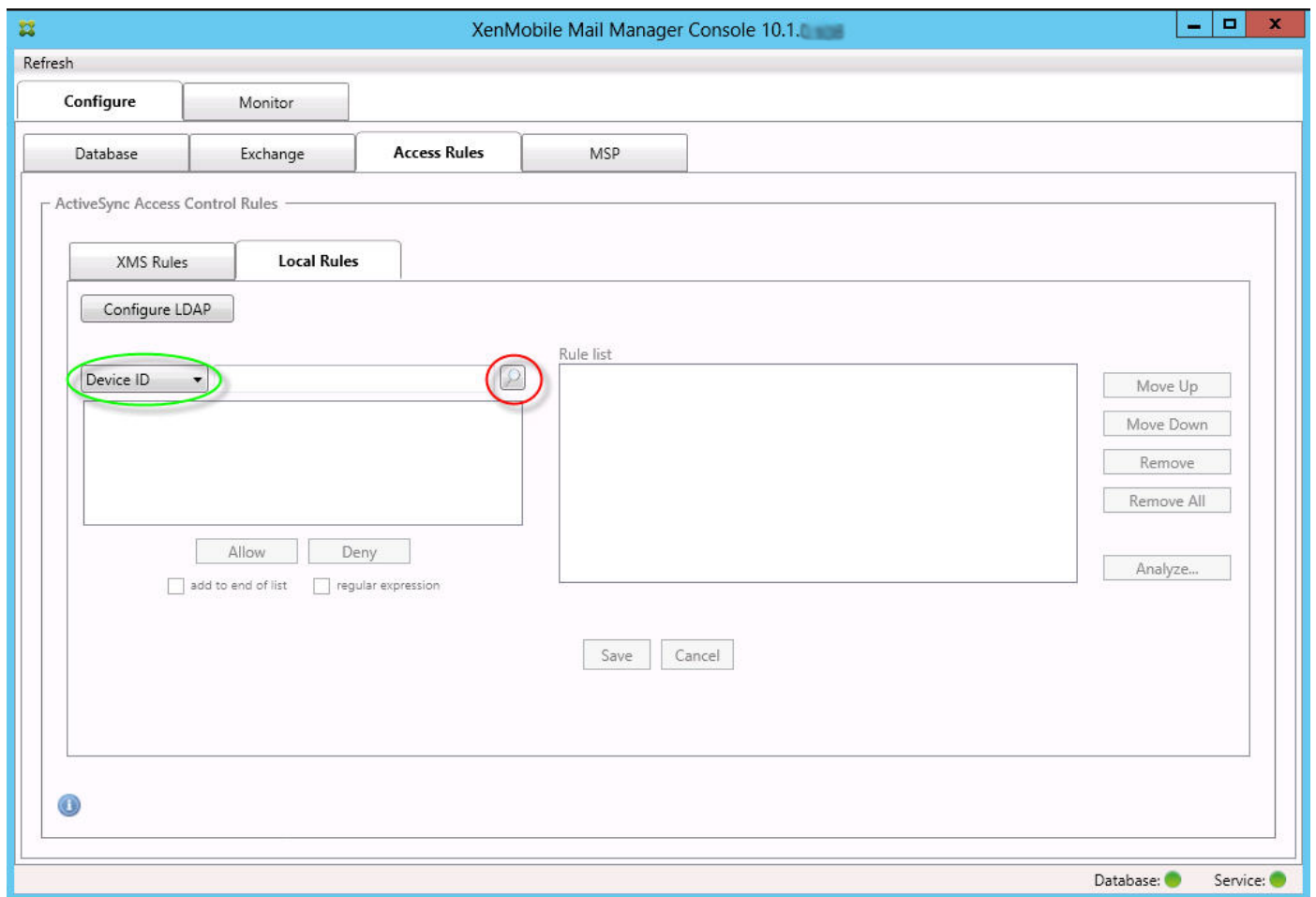

2. In the Device ID list, select the field for which you want to create a regular expression Local Rule.
3. Click on the magnifying glass icon to display all of the unique matches for the chosen field. In this example, the field Device Type has been chosen and the choices are shown below in the list box.

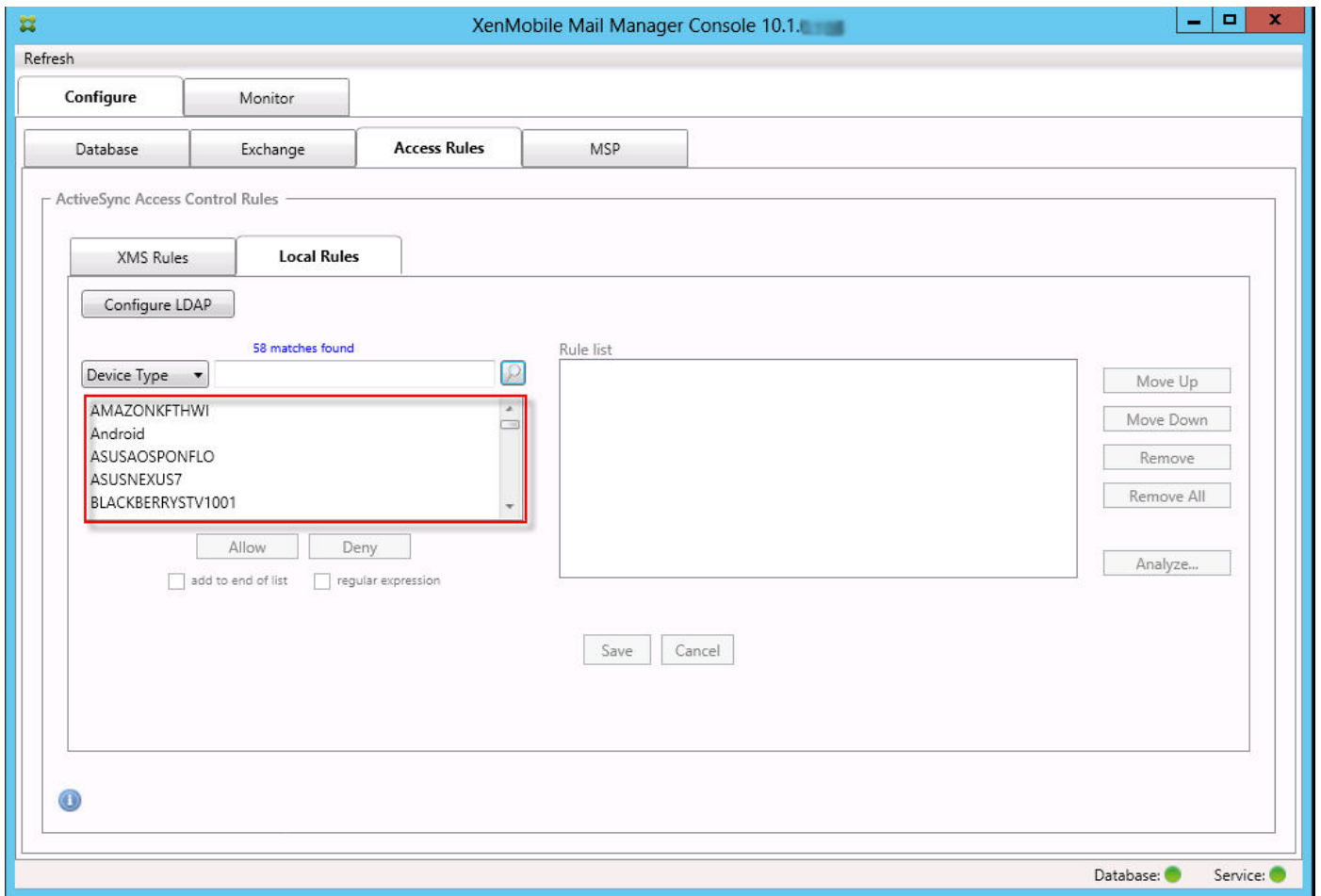

4. Click one of the items in the results list. In this example, SAMSUNGSPHL720 has been selected and appears in the text box adjacent to Device Type.

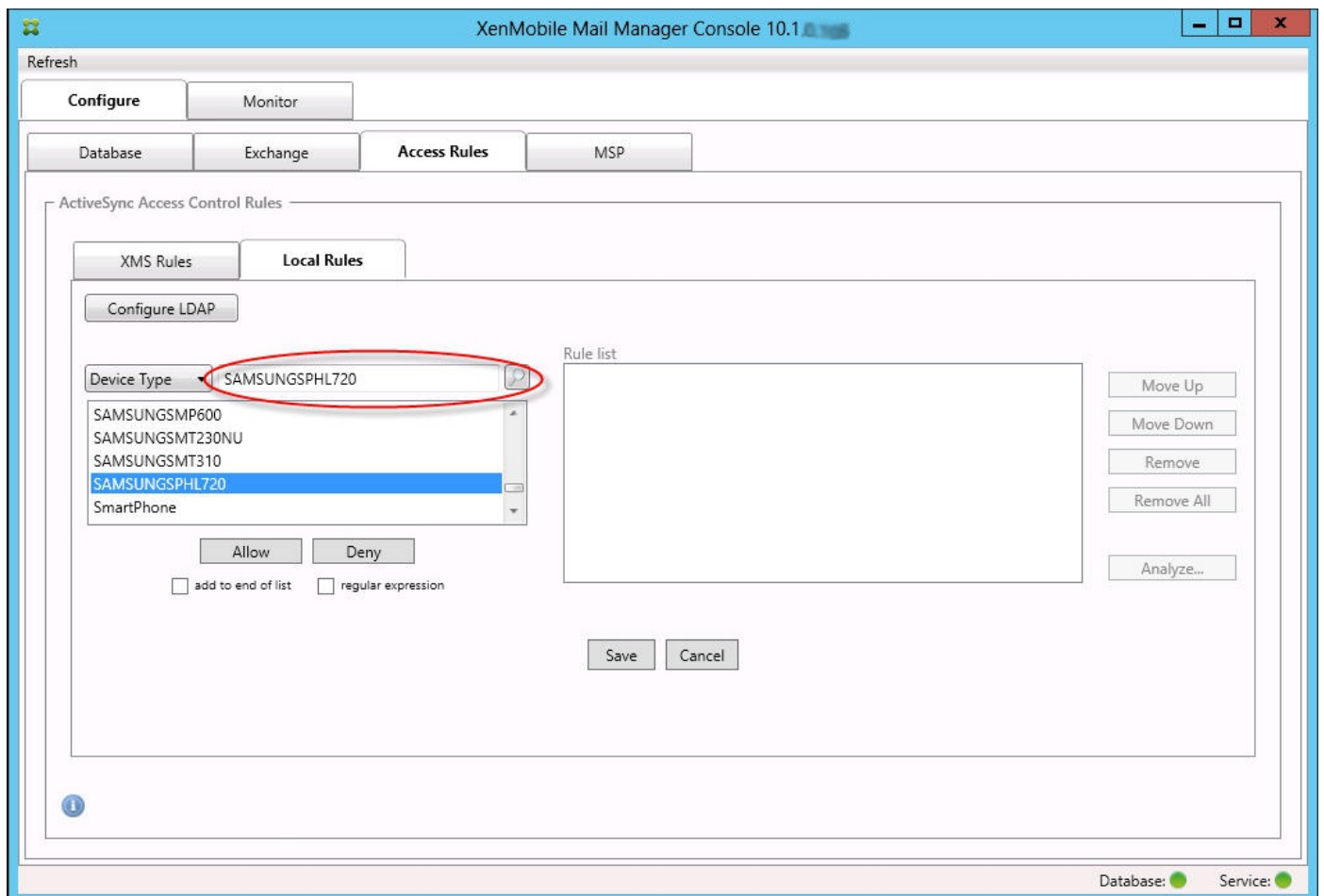

5. To allow all device types that have "Samsung" in their device type value, add a regular expression rule by following these steps:
 1. Click within the selected item text box.
 2. Change the text from SAMSUNGSPHL720 to SAMSUNG.*
 3. Make sure that the regular expression check box is selected.
 4. Click Allow.

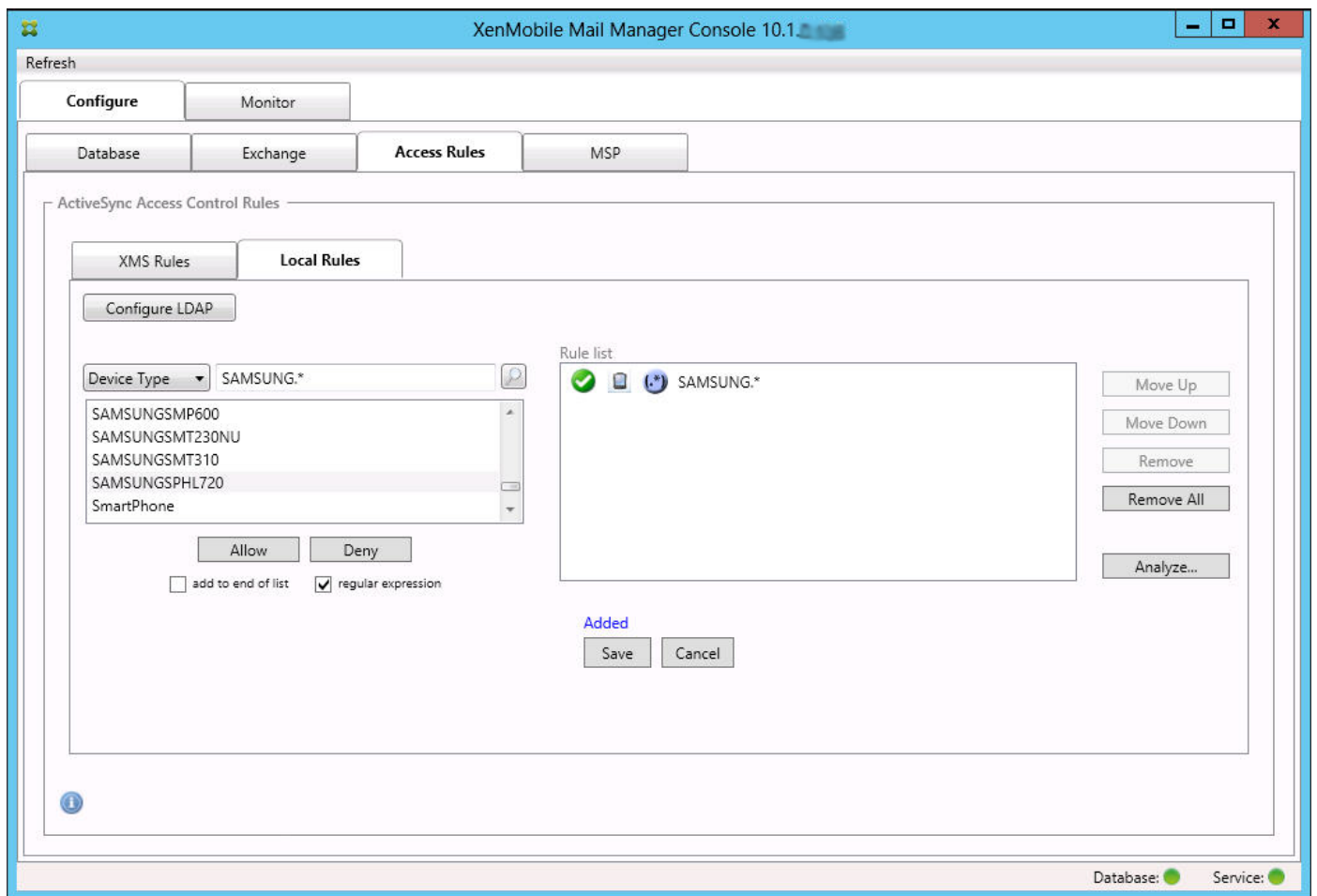

To build an access rule

1. Click the Local Rules tab.
2. To enter the regular expression, you need to make use of both the Device ID list and the selected item text box.

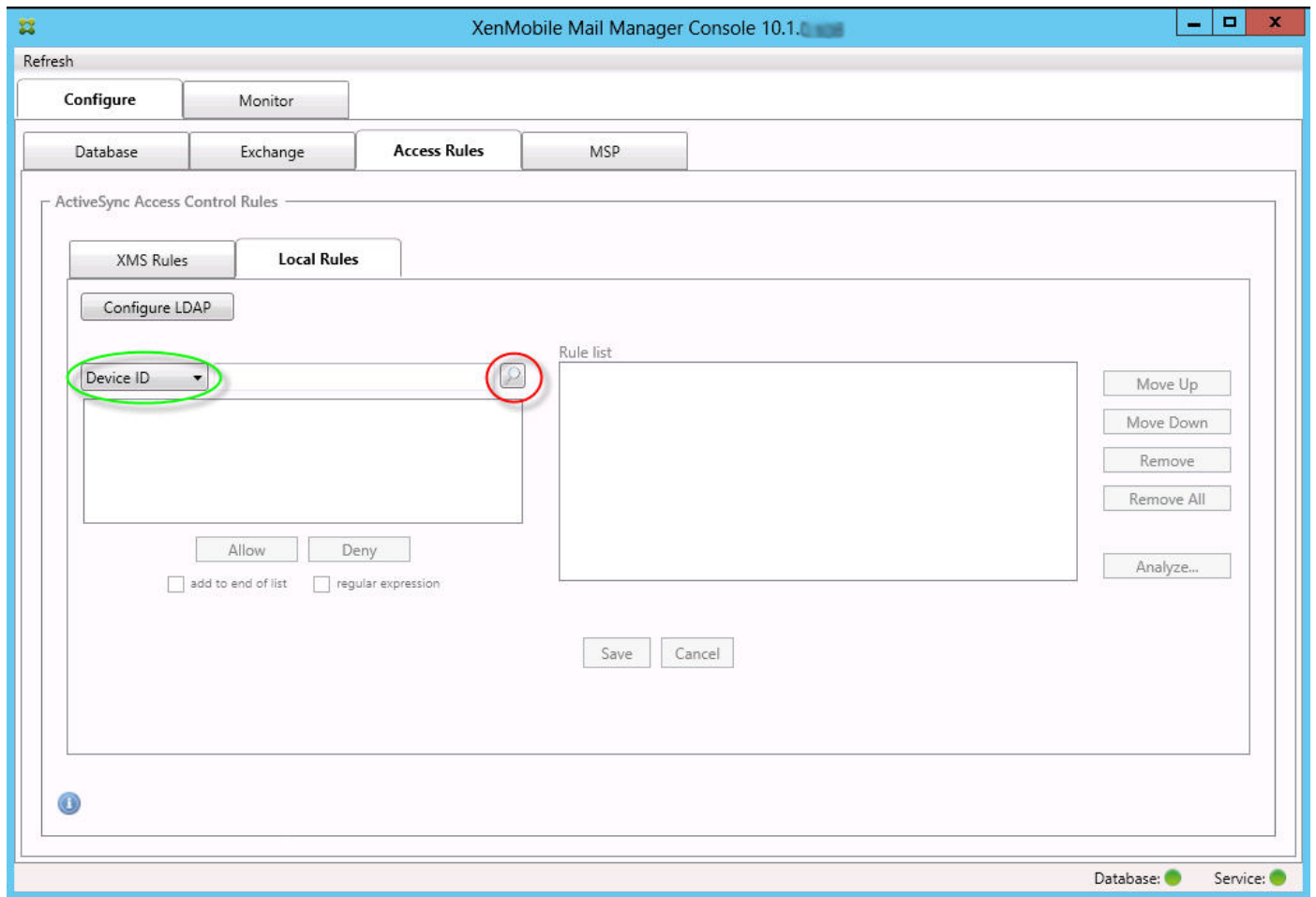

3. Select the field you want to match against. This example uses Device Type.
4. Type in the regular expression. This example uses `samsung.*`
5. Ensure that the regular expression check box is selected and then click Allow or Deny. In this example, the choice is Allow so that the final result is as follows:

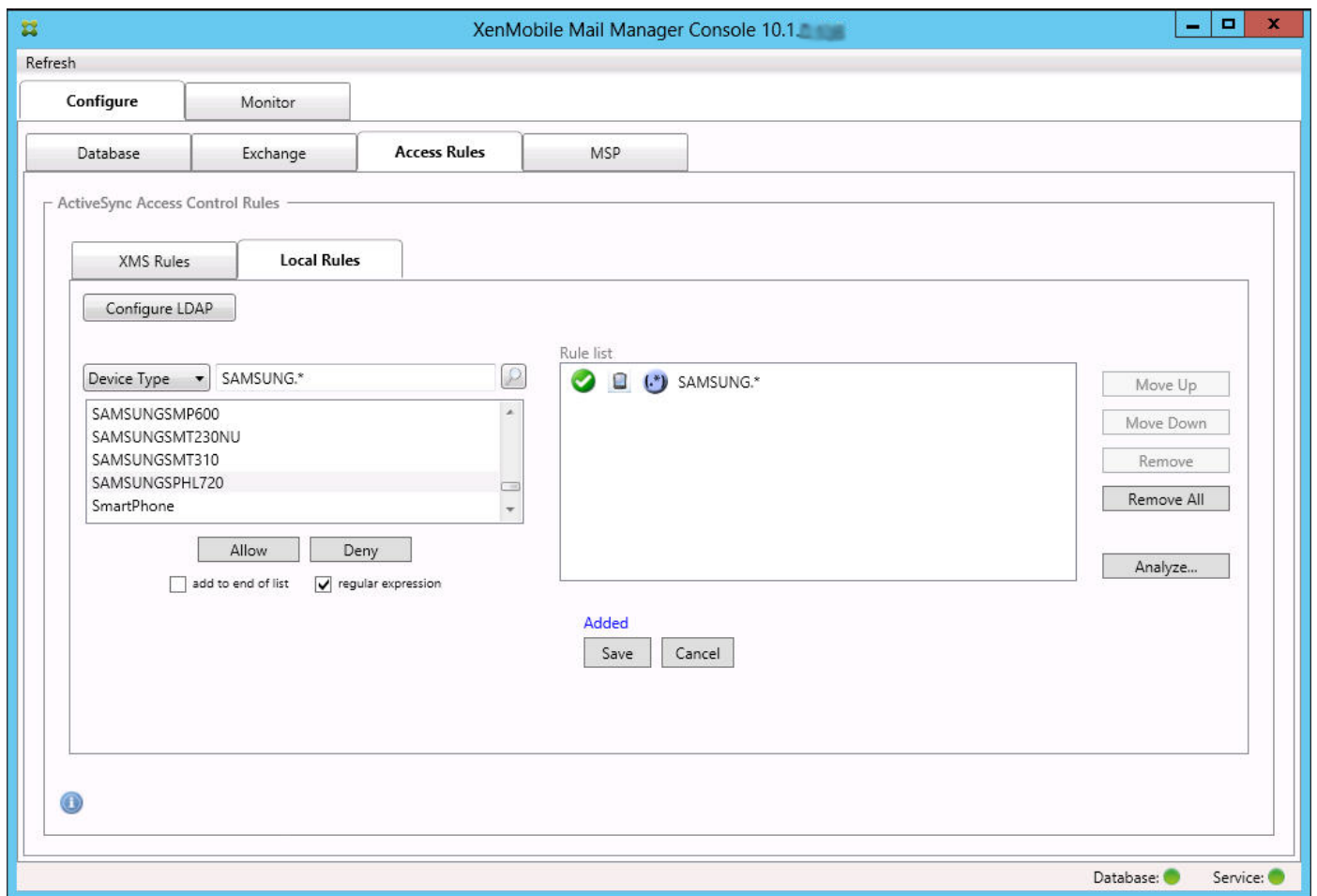

To find devices

By selecting the regular expression check box, you can run searches for specific devices that match the given expression. This feature is only available if a major snapshot has successfully completed. You can use this feature even if there is no plan to use regular expression rules. For example, assume that you want to find all devices that have the text "workmail" in their ActiveSync device ID. To do so, follow this procedure.

1. Click the Access Rules tab.
2. Ensure that the device match field selector is set to Device ID (the default).

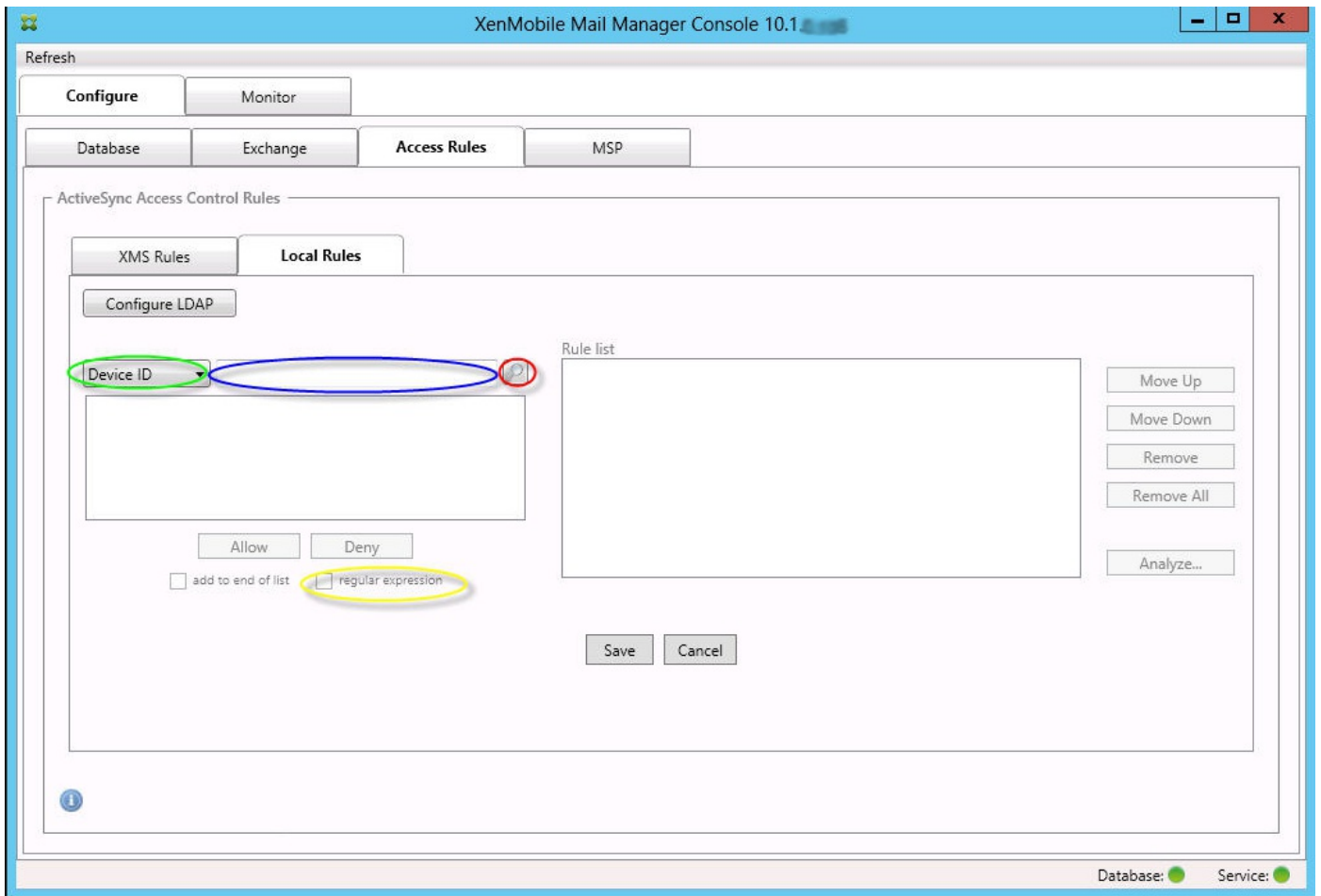

3. Click within the selected item text box (as shown in blue in the preceding figure) and then type workmail.*.
4. Make sure the regular expression check box is selected and then click the magnifying glass icon to display matches as shown in the following figure.

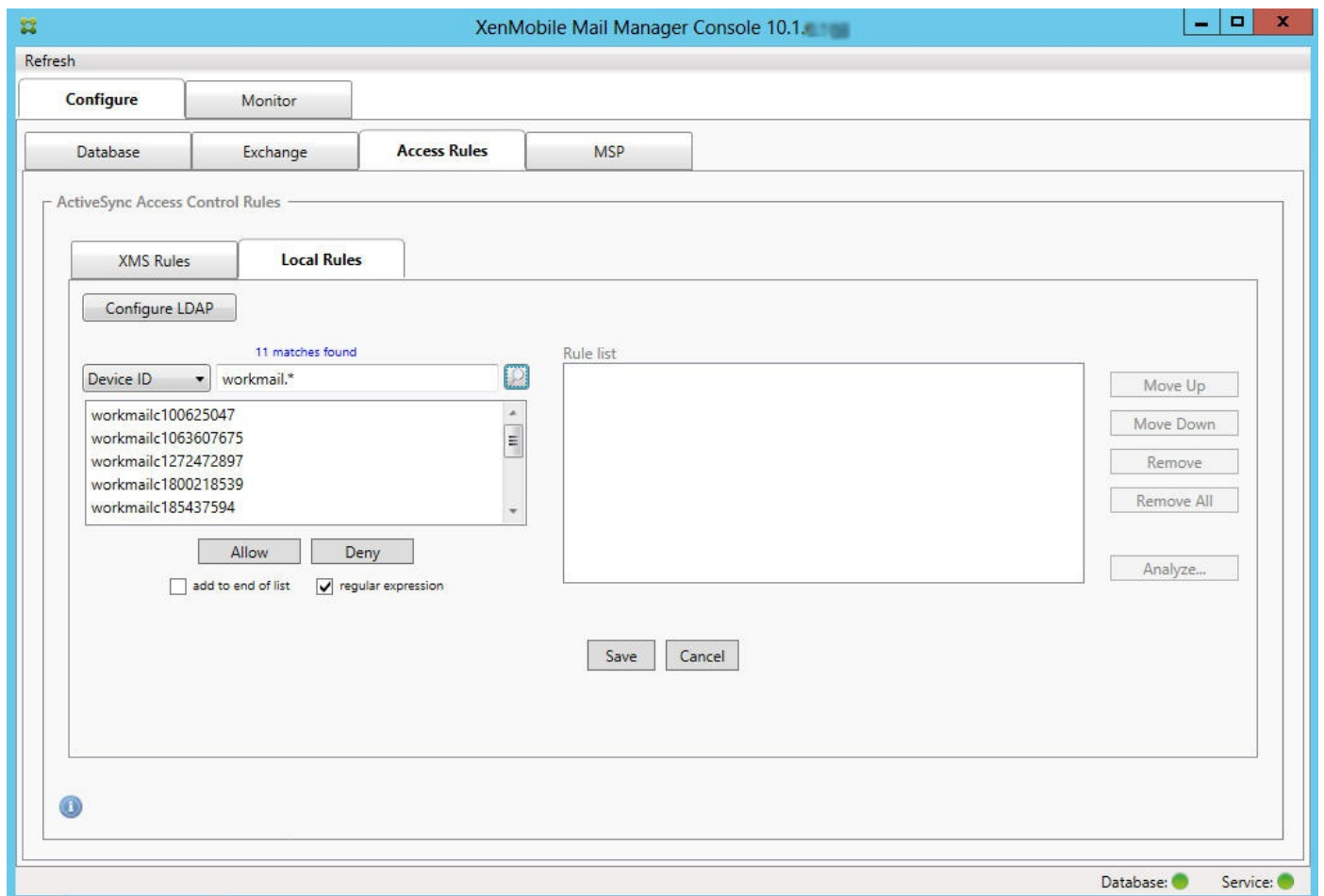

To add an individual user, device, or device type to a static rule

You can add static rules based on user, device ID, or device type on the ActiveSync Devices tab.

1. Click the ActiveSync Devices tab.
2. In the list, right-click a user, device, or device type and select whether to allow or deny your selection.

The following image shows the Allow/Deny option when user1 is selected.

XenMobile Mail Manager Console 10.1

Refresh

Configure **Monitor**

ActiveSync Devices Blackberry Devices Automation History

Selection

All Devices Anytime User: user Device: Go Export...

Reported State	Requested State	User	Device ID	Type	Model
✓	?	auser1@xmlab.net	workmailc1800218539	MOTOROLAXT1528	XT1528
User Agent: WorkMail/10.3.0.225 (MOT Identity: xmlab.net/XM1/Lorna J Chan Last snapshot: 8/10/2016 1:49:52 PM First Sync: 4/12/2016 2:28:49 PM					
✓	?	auser1@xmlab.net	A182EB4483E64A99B4CED204444A63C7	iPad	iPad
✓	?	auser101@xmlab.net	96D3D564B5EA4EF28E891EE1D987817A	iPad	iPad
✓	?	auser101@xmlab.net	E4562615700543C58C68E5125D67DFBD	iPad	iPad
✓	?	auser101@xmlab.net	38939C2CE9254CE5A0A2ED18E906F9C1	iPhone	iPhone
✓	?	auser101@xmlab.net	workmailc680977375	MOTOROLAXT1068	XT1068
✓	?	auser101@xmlab.net	workmailc1929821768	MOTOROLANEXUS6	Nexus 6
✓	?	auser101@xmlab.net	0BD6E5254A6348FC9E3BF3EAF8FD8901	iPhone	iPhone
✓	?	auser101@xmlab.net	580D5785F02F48669457BD7E680DB38B	iPhone	iPhone
✓	?	auser101@xmlab.net	7DA7ED6B6ACE43C3928C6C357F6D7B97	iPhone	iPhone
✓	?	auser101@xmlab.net	workmailc185437594	HTCNEXUS9	Nexus 9
✓	?	auser101@xmlab.net	workmailc100625047	SAMUNGSM230NU	SM-T230NU
✓	?	auser101@xmlab.net	2FAFE4CF00794BA18AB4647F581C0148	iPhone	iPhone

70 records read, 39 records displayed

Database: ● Service: ●

Device monitoring

Jun 19, 2017

The Monitor tab in XenMobile Mail Manager lets you browse the Exchange ActiveSync and BlackBerry devices that have been detected and the history of automated PowerShell commands that have been issued. The Monitor tab has the following three tabs:

- ActiveSync Devices:
 - You can export the displayed ActiveSync device partnerships by clicking the Export button.
 - You can add Local (static) rules by right-clicking the User, Device ID, or Type columns and selecting the appropriate allow or block rule type.
 - To collapse an expanded row, Ctrl-click the expanded row.
- Blackberry Devices
- Automation History

The Configure tab shows the history of all snapshots. Snapshot history shows when the snapshot took place, how long it took, how many devices were detected and any errors that occurred:

- On the Exchange tab, click the Info icon for the desired Exchange Server.
- Under the MSP tab, click the Info icon for the desired BlackBerry Server.

Troubleshooting and diagnostics

Jun 19, 2017

XenMobile Mail Manager logs errors and other operational information to its log file: <Install Folder>\log\XmmWindowsService.log. XenMobile Mail Manager also logs significant events to the Windows Event Log.

Common Errors

The following list includes common errors:

XenMobile Mail Manager service doesn't start

Check the log file and the Windows Event Log for errors. Typical causes are as follows:

- The XenMobile Mail Manager service cannot access the SQL Server. This may be caused by these issues:
 - The SQL Server service is not running.
 - Authentication failure.

If Windows Integrated authentication is configured, the user account of the XenMobile Mail Manager service must be an allowed SQL logon. The account of the XenMobile Mail Manager service defaults to Local System, but may be changed to any account that has local administrator privileges. If SQL authentication is configured, the SQL logon must be properly configured in SQL.

- The port configured for the Mobile Service Provider (MSP) is not available. A listening port must be selected that is not used by another process on the system.

XenMobile cannot connect to the MSP

Check that the MSP service port and transport is properly configured in the Configure> MSP tab of the XenMobile Mail Manager console. Check that the Authorization Group or User is set properly.

If HTTPS is configured, a valid SSL server certificate must be installed. If IIS is installed, IIS Manager can be used to install the certificate. If IIS is not installed, see <http://msdn.microsoft.com/en-us/library/ms733791.aspx> for details on installing certificates.

XenMobile Mail Manager contains a utility program to test connectivity to the MSP service. Run the <InstallFolder>MspTestServiceClient.exe program and set the URL and credentials to a URL and credentials that will be configured in the XenMobile and then click Test Connectivity. This simulates the web service requests that XenMobile service issues. Note that if HTTPS is configured, you must specify the actual host name of the server (the name specified in the SSL certificate).

Note: When using **Test Connectivity**, be sure to have at least one ActiveSyncDevice record or the test may fail.

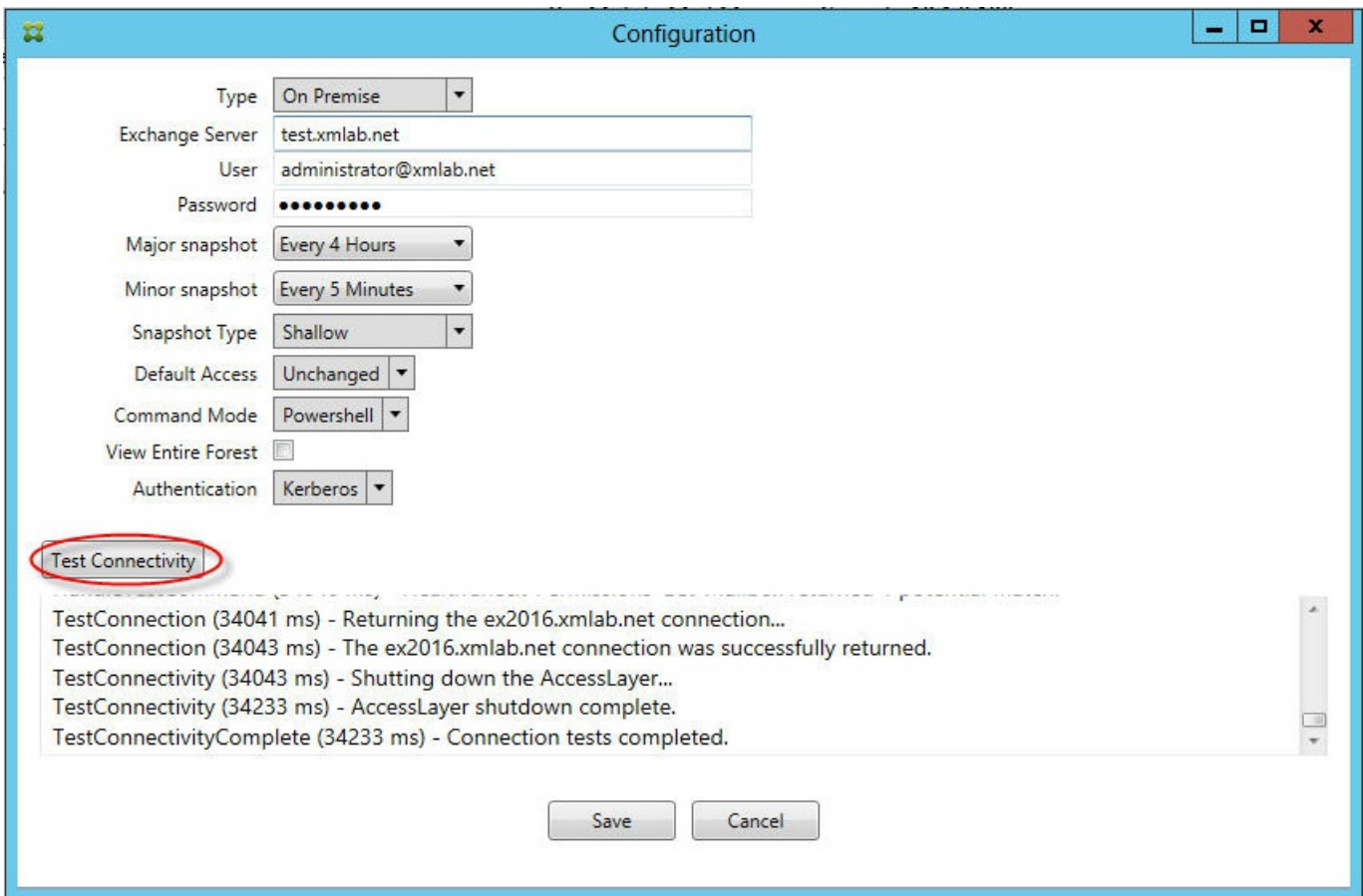

Troubleshooting Tools

A set of PowerShell utilities for troubleshooting is available in the Support\PowerShell folder.

A troubleshooting tool performs in-depth analysis of user mailboxes and devices, detecting error conditions and potential areas of failure, and in-depth RBAC analysis of users. It can save raw output of all cmdlets to a text file.

XenMobile NetScaler Connector

Jun 19, 2017

XenMobile NetScaler Connector provides a device-level authorization service of ActiveSync clients to NetScaler acting as a reverse proxy for the Exchange ActiveSync protocol. Authorization is controlled by a combination of policies that you define within XenMobile and by rules defined locally by XenMobile NetScaler Connector.

For more information, see the following articles:

- [XenMobile NetScaler Connector](#)
- [ActiveSync Gateway in XenMobile](#)

For a detailed reference architecture diagram, see the XenMobile Deployment Handbook article, [Reference Architecture for On-Premises Deployments](#).

Monitoring XenMobile NetScaler Connector

Jun 19, 2017

The XenMobile NetScaler Connector configuration utility provides detailed logging that you can use to view all traffic passing through your Exchange Server that is either allowed or blocked by Secure Mobile Gateway.

Use the Log tab to view the history of the ActiveSync requests forwarded to XenMobile NetScaler Connector by NetScaler for authorization.

Also, to make sure the XenMobile NetScaler Connector web service is running, you can load the following URL into a browser on the XenMobile NetScaler Connector server `http://<host:port>/services/ActiveSync/Version`. If the URL returns the product version as a string, the web service is responsive.

To simulate ActiveSync traffic with XenMobile NetScaler Connector

Jun 19, 2017

You can use the XenMobile NetScaler Connector to simulate what ActiveSync traffic will look like in conjunction with your policies. In the XenMobile NetScaler Connector configuration utility, select the Simulations tab. The results show you how your policies will apply according to the rules you have configured.

Choosing Filters for XenMobile NetScaler Connector

Jun 19, 2017

The XenMobile NetScaler Connector filters work by analyzing a device for a given policy violation or property setting. If the device meets the criteria, the device is placed in a Device List. This Device List is neither an allow list or a block list. It is a list of devices that meet the criteria defined. The following filters are available for XenMobile NetScaler Connector within XenMobile.

- **Blacklisted Apps.** Allows or denies devices based on the Device List defined by blacklist policies and the presence of blacklisted apps.
- **Whitelisted Apps only.** Allows or denies devices based on the Device List defined by whitelist policies and the presence of non-whitelisted apps.
- **Unmanaged Devices.** Creates a Device List of all devices in the XenMobile database. The Mobile Application Gateway needs to be deployed in a Block Mode.
- **Rooted Android /Jailbroken iOS Devices.** Creates a Device List of all devices flagged as rooted and allows or denies based on rooted status.
- **Out of Compliance Devices.** Allows you to deny or allow devices that meet your own internal IT compliance criteria. Compliance is an arbitrary setting defined by the device property named Out of Compliance, which is a Boolean flag that can be either True or False. (You can create this property manually and set the value, or you can use Automated Actions to create this property on a device if the device does or does not meet specific criteria.)
 - **Out of Compliance = True.** If a device does not meet the compliance standards and policy definitions set by your IT department, the device is out of compliance.
 - **Out of Compliance = False.** If a device does meet the compliance standards and policy definitions set by your IT department, the device is compliant.
- **Noncompliant password.** Creates a Device List of all devices that do not have a passcode on the device.
- **Revoked Status.** Creates a Device List of all revoked devices and allows or denies based on revoked status.
- **Inactive devices.** Creates a Device List of devices that have not communicated with XenMobile within a specified period of time and are thus considered inactive and allows or denies the devices accordingly.
- **Anonymous Devices.** Allows or denies devices that are enrolled in XenMobile but the user's identity is unknown. For example, this could be a user who was enrolled, but the user's Active Directory password is expired, or a user who enrolled with unknown credentials.
- **Implicit Allow/Deny.** Creates a Device List of all devices that do not meet any of the other filter rule criteria and allows or denies based on that list. The Implicit Allow/Deny option ensures that the XenMobile NetScaler Connector status in the Devices tab is enabled and shows the XenMobile NetScaler Connector status for your devices. The Implicit Allow/Deny option also controls all of the other XenMobile NetScaler Connector filters that have not been selected. For example, Blacklists Apps will be denied (blocked) by XenMobile NetScaler Connector, whereas all other filters will be allowed because the Implicit Allow/Deny option is selected to Allow.

To configure a connection to XenMobile NetScaler Connector

Jun 19, 2017

XenMobile NetScaler Connector communicates with XenMobile and other remote configuration providers through secure web services.

1. In the XenMobile NetScaler Connector configuration utility, click the Config Providers tab and then click Add.
2. In the Config Providers dialog box, in Name, enter a user name that has administrative privileges and will be used for basic HTTP authorization with the XenMobile server.
3. In Url, enter the web address of the XenMobile GCS, typically in the format `https://ZdmHost/zdm/services/MagConfigService`. The `MagConfigService` name is case-sensitive.
4. In Password, enter the password that will be used for basic HTTP authorization with the XenMobile server.
5. In Managing Host, enter the XenMobile NetScaler Connector server name.
6. In Baseline Interval, specify a time period for when a new refreshed dynamic ruleset is pulled from Device Manager.
7. In Delta interval, specify a time period for when an update of dynamic rules is pulled.
8. In Request Timeout, specify the server request timeout interval.
9. In Config Provider, select if the configuration provider server instance is providing the policy configuration.
10. In Events Enabled, enable this option if you want XenMobile NetScaler Connector to notify XenMobile when a device is blocked. This option is required if you are using the XenMobile NetScaler Connector rules in any of your XenMobile Automated Actions.
11. Click Save and then click Test Connectivity to test gateway-to-configuration provider connectivity. If the connection fails, check that the local firewall settings allow the connection or contact your administrator.
12. When the connection succeeds, clear the Disabled check box and then click Save.

When you add a new configuration provider, XenMobile NetScaler Connector automatically creates one or more policies associated with the provider. These policies are defined by a template definition contained in `config\policyTemplates.xml` in the `NewPolicyTemplate` section. For each `Policy` element defined within this section, a new policy is created. The operator may add, remove, or modify policy elements provided that the policy element conforms to the schema definition, and that the standard substitution strings (enclosed in braces) are not modified. Next, add new groups for the provider and update the policy to include the new groups.

To import a policy from XenMobile

Jun 19, 2017

1. In the XenMobile NetScaler Configuration configuration utility, click the Config Providers tab and then click Add.
2. In the Config Providers dialog box, in Name, enter a user name that will be used for basic HTTP authorization with the XenMobile server and that has administrative privileges.
3. In Url, enter the web address of the XenMobile Gateway Configuration Service (GCS), typically in the format `https://xdmHost/xdm/services/MagConfigService`. The MagConfigService name is case-sensitive.
4. In Password, enter the password that will be used for basic HTTP authorization with the XenMobile server.
5. Click Test Connectivity to test gateway-to-configuration provider connectivity. If the connection fails, check that your local firewall settings allow the connection or check with your administrator.
6. When a connection is successfully made, clear the Disabled check box and then click Save.
7. In Managing Host, leave the default DNS name of the local host computer. This setting used to coordinate communication with XenMobile when multiple Forefront Threat Management Gateway (TMG) servers are configured in an array.

After you save the settings, open the GCS.

Configuring XenMobile NetScaler Connector Policy Modes

Jun 19, 2017

XenMobile NetScaler Connector can run in the following six modes:

- Allow All. This policy mode grants access for all traffic passing through XenMobile NetScaler Connector. No other filtering rules are used.
- Deny All. This policy mode blocks access for all traffic passing through XenMobile NetScaler Connector. No other filtering rules are used.
- Static Rules: Block Mode. This policy mode executes static rules with an implicit deny or block statement at the end. Devices that are not allowed or permitted via other filter rules are blocked by XenMobile NetScaler Connector.
- Static Rules: Permit Mode. This policy mode executes static rules with an implicit permit or allow statement at the end. Devices that are not blocked or denied via other filter rules are allowed through XenMobile NetScaler Connector.
- Static + ZDM Rules: Block Mode. This policy mode executes static rules first, followed by dynamic rules from XenMobile with an implicit deny or block statement at the end. Devices are permitted or denied based on defined filters and Device Manager rules. Any devices that do not match on defined filters and rules are blocked.
- Static + ZDM Rules: Permit Mode. This policy mode executes static rules first, followed by dynamic rules from XenMobile with an implicit permit or allow statement at the end. Devices are permitted or denied based on defined filters and XenMobile rules. Any devices that do not match on defined filters and rules are allowed.

The XenMobile NetScaler Connector process permits or blocks for dynamic rules based on unique ActiveSync IDs for iOS and Windows-based mobile devices received from XenMobile. Android devices differ in their behavior based on the manufacturer and some do not readily expose a unique ActiveSync ID. To compensate, XenMobile sends user ID information for Android devices to make a permit or block decision. As a result, if a user has only one Android device, permits and blocks function normally. If the user has multiple Android devices, all the devices are allowed because Android devices cannot be definitively differentiated. The gateway can still be configured to statically block these devices by ActiveSyncID, if they are known, and can also be configured to block based on device type or user agent.

To specify the policy mode, in the SMG Controller Configuration utility, do the following:

1. Click the Path Filters tab and then click Add.
2. In the Path Properties dialog box, select a policy mode from the Policy drop-down list and then click Save.

You can review rules on the Policies tab of the configuration utility. The rules are processed on XenMobile NetScaler Connector from top to bottom. The Allow policies are displayed with green checkmark. The Deny policies are shown as a red circle with a line through it. To refresh the screen and see the most updated rules, click Refresh. You can also modify the ordering of rules in the config.xml file.

To test rules, click the Simulator tab. Specify values in the fields. These can also be obtained from the logs. A result message will appear specifying Allow or Block.

To configure static rules

Jun 19, 2017

You must enter static rules with values that are read by the ISAPI filtering of the ActiveSync connection HTTP request. Static rules enable XenMobile NetScaler Connector to permit or block traffic by the following criteria:

- **User.** XenMobile NetScaler Connector uses the authorized user value and name structure that was captured during device enrollment. This is commonly found as domain\username as referenced by the server running XenMobile connected to Active Directory via LDAP. The Log tab within the XenMobile NetScaler Connector configuration utility will show the values that are passed through XenMobile NetScaler Connector if the value structure needs to be determined or is different.
- **Deviceid (ActiveSyncID).** Also known as the ActiveSyncID of the connected device. This value is commonly found within the specific device properties page in the XenMobile console. This value can also be screened from the Log tab in the XenMobile NetScaler Connector configuration utility.
- **DeviceType.** XenMobile NetScaler Connector can determine if a device is an iPhone, iPad, or other device type and can permit or block based on that criteria. As with other values, the XenMobile NetScaler Connector configuration utility can reveal all connected device types being processed for the ActiveSync connection.
- **UserAgent.** Contains information on the ActiveSync client that is used. In most cases, the value specified corresponds to a specific operating system build and version for the mobile device platform.

The XenMobile NetScaler Connector configuration utility running on the server always manages the static rules.

1. In the SMG Controller Configuration utility, click the Static Rules tab and then click Add.
2. In the Static Rule Properties dialog box, specify the values that you want to use as criteria. For example, you can enter a user to allow access by entering the user name (for example, AllowedUser) and then clearing the Disabled check box.
3. Click Save. The static rule is now in effect. Additionally, you can use regular expressions to define values, but you must enable the rule processing mode in the config.xml file.

To configure dynamic rules

Jun 19, 2017

Dynamic rules are defined by device policies and properties in Device Manager and can trigger a dynamic XenMobile NetScaler Connector or filter based on the presence of a policy violation or property setting. The XenMobile NetScaler Connector filters work by analyzing a device for a given policy violation or property setting. If the device meets the criteria, the device is placed in a Device List. This Device List is neither an allow list or a block list. It is a list of devices that meets the criteria defined. The following configuration options enable you to define whether you want to allow or deny the devices in the Device List by using XenMobile NetScaler Connector.

Note: These dynamic rules must be configured in the XenMobile console.

1. In the XenMobile console, click the gear icon in the upper-right corner. The **Settings** page appears.
2. Under **Server**, click **ActiveSync Gateway**. The ActiveSync Gateway page appears.
3. In **Activate the following rules**, select one or more rules you want to activate.
4. In Android-only, in **Send Android domain users to ActiveSync Gateway**, click **YES** to ensure that XenMobile sends Android device information to the Secure Mobile Gateway. When this option is enabled, it ensures that XenMobile sends Android device information to the XenMobile NetScaler Connector in the event that XenMobile does not have the ActiveSync identifier for the Android device user.

To configure custom policies by editing the XenMobile NetScaler Connector XML file

Jun 19, 2017

You can view the basic policies in the default configuration on the Policies tab of the XenMobile NetScaler Connector configuration utility. If you want to create custom policies, you can edit the XenMobile NetScaler Connector XML configuration file (config\config.xml).

1. Find the PolicyList section in the file and then add a new Policy element.
2. If a new group is also required, such as an additional static group or a group to support an additional GCP, add the new Group element to the GroupList section.
3. Optionally, you can change the ordering of groups within an existing policy by rearranging the GroupRef elements.

Configuring the XenMobile NetScaler Connector XML File

Jun 19, 2017

The XenMobile NetScaler Connector uses an XML configuration file to dictate the actions of XenMobile NetScaler Connector. Among other entries, the file specifies the group files and associated actions the filter will take when evaluating HTTP requests. By default, the file is named config.xml and can be found at the following location: ..\Program Files\Citrix\XenMobile NetScaler Connector\config\.

GroupRef Nodes

The GroupRef nodes define the logical group names - by default, the AllowGroup and the DenyGroup.

Note: The order of the GroupRef nodes as they appear in the GroupRefList node is significant.

The ID value of a GroupRef node identifies a logical container or collection of members that are used for matching specific user accounts or devices. The action attributes specifies how the filter will treat a member that matches a rule in the collection. For example, a user account or device that matches a rule in the AllowGroup set will "pass" (be allowed to access the Exchange CAS), while a user account or device that matches a rule in the DenyGroup set will be "rejected" (not allowed to access the Exchange CAS).

When a particular user account/device or combination meets rules in both groups, a precedence convention is used to direct the request's outcome. Precedence is embodied in the order of the GroupRef nodes in the config.xml file from top to bottom. The GroupRef nodes are ranked in priority order. Rules for a given condition in the Allow group will always take precedence over rules for the same condition in the Deny group.

Group Nodes

Additionally, the config.xml defines Group nodes. These nodes link the logical containers AllowGroup and DenyGroup to external XML files. Entries stored in the external files form the basis of the filter rules.

Note: In this release, only external XML files are supported.

The default installation implements two XML file in the configuration - allow.xml and deny.xml.

Configuring XenMobile NetScaler Connector

Jun 19, 2017

You can configure XenMobile NetScaler Connector to selectively block or allow ActiveSync requests based on the following properties: Active Sync Service ID, Device type, User Agent (device operating system), Authorized user, and ActiveSync Command.

The default configuration supports a combination of static and dynamic groups. You maintain static groups by using the SMG Controller Configuration utility. The static groups may consist of known categories of devices, such as all devices using a given user agent.

Dynamic groups are maintained by an external source called a Gateway Configuration Provider and collected by XenMobile NetScaler Connector on a periodic basis. XenMobile can export groups of allowed and blocked devices and users to XenMobile NetScaler Connector.

A policy is an ordered list of groups in which each group has an associated action (allow or block) and a list of group members. A policy may have any number of groups. Group ordering within a policy is important because when a match is found the action of the group is taken, and subsequent groups are not evaluated.

A member defines a way to match the properties of a request. It can match a single property, such as device ID, or multiple properties, such as device type and user agent.

Choosing a Security Model for XenMobile NetScaler Connector

Jun 19, 2017

Permissive Model (Permit Mode)

Establishing a security model is essential to a successful mobile device deployment for organizations of any size. Although it is not uncommon to use protected or quarantined network control to allow access to a user, computer, or device by default, it is not always a good practice. Every organization that manages IT security may have a slightly different or tailored approach to security for mobile devices.

The same logic applies to mobile device security. The vast numbers of mobile devices and types, quantities of mobile devices per user, and the array of operating system platforms and apps available make the very idea of using a permissive model a weak choice. In most organizations, the restrictive model will be the most logical choice.

The configuration scenarios that Citrix allows for integrating XenMobile NetScaler Connector with XenMobile are as follows:

The permissive security model operates on the premise that everything is either allowed or granted access by default. Only in the case of rules and filtering will something be blocked and a restriction applied. The permissive security model is good for organizations that have a relatively loose security concern about mobile devices and only applies restrictive controls to deny access where appropriate (when a policy rule is failed).

The Restrictive Model (Block Mode)

The restrictive security model is based on the premise that nothing is allowed or granted access by default. Everything passing through the security check point is filtered and inspected, and is denied access unless the rules allowing access are passed. The restrictive security model is good for organizations that have a relatively tight security criterion about mobile devices. The mode only grants access for use and functionality with the network services when all rules to allow access have passed.

Managing XenMobile NetScaler Connector

Jun 19, 2017

You can use XenMobile NetScaler Connector to build access control rules to either allow or block access to ActiveSync connection requests from managed devices, based on device status, app blacklists or whitelists, and other compliance conditions.

By using the XenMobile NetScaler Connector configuration utility, you can build dynamic and static rules that enforce corporate email policies, allowing you to block users who are in violation of compliance standards. You can also set up email attachment encryption, so that all attachments that pass through your Exchange Server to managed devices are encrypted and only viewable on managed devices by authorized users.

To uninstall the XNC

Jun 19, 2017

1. Run XncInstaller.exe with an administrator account.
2. Follow the onscreen instructions to complete the uninstallation.

To install, upgrade, or uninstall XenMobile NetScaler Connector

Jun 19, 2017

1. Run XncInstaller.exe with an administrator account to install XenMobile NetScaler Connector (XNC) or allow for upgrade or removal of an existing XenMobile NetScaler Connector.
2. Follow the onscreen instructions to complete the installation, upgrade, or uninstallation.

After you install XenMobile NetScaler Connector, you must manually restart the XenMobile configuration service and the notification service.

Installing XenMobile NetScaler Connector

Jun 19, 2017

You can install XenMobile NetScaler Connector on its own server or on the same server where you installed XenMobile.

You can consider installing XenMobile NetScaler Connector on its own server (separate from XenMobile) for the following reasons:

- If your XenMobile server is hosted remotely in the cloud (physical location).
- If you do not want XenMobile NetScaler Connector to be affected by restarts of the XenMobile server (availability).
- If you want a server's system resources to be devoted entirely to XenMobile NetScaler Connector (performance).

The CPU load that XenMobile NetScaler Connector puts on a server depends on how many devices are managed, but a general rule of thumb is to provision for one additional CPU core if XenMobile NetScaler Connector is deployed on the same server as XenMobile. For large numbers of devices (more than 50,000), you may need to provision additional cores if you do not have a clustered environment. The memory footprint of XenMobile NetScaler Connector is not significant enough to warrant additional memory.

XenMobile NetScaler Connector System Requirements

Jun 19, 2017

XenMobile NetScaler Connector communicates with NetScaler over an SSL bridge configured on the NetScaler appliance that enables the appliance to bridge all secure traffic directly to XenMobile. XenMobile NetScaler Connector requires the following minimum system configuration:

Component	Requirement
Computer and processor	733 MHz Pentium III 733 MHz or higher processor. 2.0 GHz Pentium III or higher processor (recommended)
NetScaler	NetScaler appliance with software version 10
Memory	1 GB
Hard disk	NTFS-formatted local partition with 150 MB of available hard-disk space
Operating system	Microsoft Windows Server 2008 R2, Microsoft Windows Server 2008 SP2, Microsoft Windows Server 2012 R2
Other devices	Network adapter compatible with the host operating system for communication with the internal network
Display	VGA or higher-resolution monitor

The host computer for XenMobile NetScaler Connector requires the following minimum available hard disk space:

- Application. 10 -15 MB (100 MB recommended)
- Logging. 1 GB (20 GB recommended)

For information about platform support for XenMobile NetScaler Connector, see [Supported Device Platforms in XenMobile](#).

Device email clients

Not all email clients consistently return the same ActiveSync ID for a device. Because XenMobile NetScaler Connect expects a unique ActiveSync ID for each device, only email clients that consistently generate the same, unique ActiveSync ID for each device are supported. These email clients have been tested by Citrix and performed without errors:

- HTC native email client
- Samsung native email client
- iOS native email client
- TouchDown

Deploying XenMobile NetScaler Connector

Jun 19, 2017

XenMobile NetScaler Connector enables you to use NetScaler to proxy and load balance XenMobile server communication with XenMobile managed devices. XenMobile NetScaler Connector communicates periodically with XenMobile to synchronize policies. XenMobile NetScaler Connector and XenMobile can be clustered, together or independently, and can be load balanced by NetScaler.

XenMobile NetScaler Connector Components

XenMobile NetScaler Connector consists of the following four components:

- XenMobile NetScaler Connector service. This provides a REST web service interface that can be invoked by NetScaler to determine if an ActiveSync request from a device is authorized.
- XenMobile configuration service. This service communicates with Device Manager to synchronize Device Manager policy changes with XenMobile NetScaler Connector.
- XenMobile notification service. This service sends notifications of unauthorized device access to Device Manager so that Device Manager can take appropriate measures, such as notifying the user why the device was blocked.
- XenMobile NetScaler configuration utility. This application allows the administrator to configure and monitor XenMobile NetScaler Connector.

To set up listening addresses for XenMobile NetScaler Connector

In order for XenMobile NetScaler Connector to be able to receive requests from NetScaler to authorize ActiveSync traffic, you need to specify the port on which XenMobile NetScaler Connector listens to NetScaler web service calls.

1. From the Start menu, select the XenMobile NetScaler configuration utility.
2. Click the Web Service tab and then type the listening addresses for the XenMobile NetScaler Connector web service. You can select HTTP and/or HTTPS. If XenMobile NetScaler Connector is co-resident with XenMobile (installed on the same server), select port values that do not conflict with XenMobile.
3. After the values are configured, click Save and then click Start Service to start the web service.

To configure device access control policies in XenMobile NetScaler Connector

To configure the access control policy you want to apply to your managed devices, do the following:

1. In the XenMobile NetScaler configuration utility, click the Path Filters tab.
2. Select the first row, Microsoft-Server-ActiveSync is for ActiveSync and then click Edit.
3. From the Policy list, select the desired policy. For a policy that is inclusive of XenMobile policies, select Static + ZDM: Permit Mode or Static + ZDM: Block Mode. These policies combine local (or, static) rules with the rules from XenMobile. Permit Mode means that all devices not explicitly identified by the rules will be permitted access to ActiveSync. Block Mode means that such devices will be blocked.
4. After setting the policies, click Save.

To configure communication with XenMobile

In this task, you will specify the name and properties of the XenMobile server (also known as a Config Provider) that you want to use with XenMobile NetScaler Connector and NetScaler.

Note: This task assumes that you have already installed and configured XenMobile.

1. In the XenMobile NetScaler Connector configuration utility, click the Config Providers tab and then click Add.
2. Enter the name and URL of the XenMobile server you are using in this deployment. If you have multiple XenMobile servers deployed in a Multi-Tenant deployment, this name must be unique for each server instance. For example, for Name, you could type XMS.
3. In Url, enter the Web address of the XenMobile GlobalConfig Provider (GCP), typically in the format `https://DeviceManagerHost/zdm/services/MagConfigService`. The MagConfigService name is case-sensitive.
4. In Password, enter the password that will be used for basic HTTP authorization with the XenMobile web server.
5. In Managing Host, enter the server name where you installed XenMobile NetScaler Connector.
6. In Baseline Interval, specify a time period for when a new refreshed dynamic ruleset is pulled from XenMobile.
7. In Request Timeout, specify the server request timeout interval.
8. In Config Provider, select if the config provider server instance is providing the policy configuration.
9. In Events Enabled, enable this option if you want Secure Mobile Gateway to notify XenMobile when a device is blocked. This option is required if you are using Secure Mobile Gateway rules in any of your Device Manager Automated Actions.
10. Once the server is configured, click Test Connectivity to test the connection to the XenMobile server.
11. When connectivity has been established, click Save.

Deploying XenMobile NetScaler Connector for Redundancy and Scalability

If you want to scale your XenMobile NetScaler Connector and XenMobile deployment, you can install instances of XenMobile NetScaler Connector on multiple Windows Servers, all pointing to the same XenMobile instance, and then you can use NetScaler to load balance the servers.

There are two modes for the XenMobile NetScaler Connector configuration:

- In non-shared mode, each XenMobile NetScaler Connector instance communicates with a XenMobile server and keeps its own private copy of the resulting policy. For example, if you had a cluster of XenMobile servers, you could run a XenMobile NetScaler Connector instance on each XenMobile server and XenMobile NetScaler Connector would get policies from the local XenMobile instance.
- In shared mode, one XenMobile NetScaler Connector node is designated the primary node and it communicates with XenMobile. The resulting configuration is shared among the other nodes either by a Windows network share or by Windows (or third-party) replication.

The entire XenMobile NetScaler Connector configuration is in a single folder (consisting of a few XML files). The XenMobile NetScaler Connector process detects changes to any file in this folder and automatically reloads the configuration. There is no failover for the primary node in shared mode. But the system can tolerate the primary server being down for a few minutes (for example, to restart) because the last known good configuration is cached in the XenMobile NetScaler Connector process.

Advanced Concepts

Aug 28, 2017

The XenMobile Advanced Concepts articles offer a deeper dive into product documentation on XenMobile. The aim is to help reduce deployment time through expert techniques. The articles may cite the technical expert or experts who have authored the content.

For decision points, recommendations, common questions, and use cases for your end-to-end XenMobile environment, also in this section, see the XenMobile Deployment Handbook.

For community support forums on XenMobile, see [Citrix Discussions](#).

[On-premises XenMobile interaction with Active Directory](#)

[XenMobile Deployment Handbook](#)

On-premises XenMobile interaction with Active Directory

Siddartha Vuppala , Priyanka Joshi | Jun 19, 2017

This article explains the interaction between XenMobile Server and Active Directory. XenMobile Server interacts with Active Directory both inline and in the background. The following sections provide more information on the inline and the background operations that involve Active Directory interaction.

Note

This article is an overview of the interaction and does not cover the granular details. For more information about configuring Active Directory and LDAP in the XenMobile console, see [Domain or domain plus security token authentication](#).

Inline interactions

XenMobile Server communicates with Active Directory by using the LDAP settings that an administrator configures. The settings retrieve information about users and groups. Following are the operations that result in interaction between XenMobile Server and Active Directory.

1. **LDAP configuration.** Configuration of Active Directory itself results in an interaction with Active Directory. XenMobile Server attempts to validate the information by authenticating the information with Active Directory. The server does so by using the internet protocol, port, and service account credentials provided. A successful bind indicates that the connection is configured correctly.
2. **Group-based interactions.**
 - a. Search for one or more groups during the Role-Based Access Control (RBAC) and delivery group definition creation. The XenMobile Server administrator inputs a search text string in the XenMobile console. XenMobile Server searches the selected domain for all groups that contain the substring that is provided. Then, XenMobile Server retrieves the objectGUID, sAMAccountName, and Distinguished Name attributes of the groups identified in the search.

Note

This information is not stored in the XenMobile Server database.

- b. RBAC and deployment group definition add or update. The XenMobile Server administrator selects the Active Directory groups of interest based on the previous search and includes them in the deployment group definition. XenMobile Server searches for the specific group, one at a time, in Active Directory. XenMobile Server searches for the objectGUID attribute and retrieves selected attributes, including membership information. Group membership information helps determine membership between the group retrieved and existing users or groups in the XenMobile Server database. Changes to group membership result in the RBAC and deployment group derivation for the affected user members, which results in user entitlements.

Note

Changes to the deployment group definition can lead to change in app or policy entitlements for affected users.

c. **One-time PIN (OTP) invitations.** The XenMobile Server administrator selects a group from the list of Active Directory groups present in the XenMobile Server database. For this group, all the users, both direct and indirect, are retrieved from Active Directory. OTP invitations are sent to the users who were identified in the preceding step.

Note

The preceding three interactions imply that group-based interactions are triggered based on XenMobile Server configuration changes. When there are no changes to the configuration, the interactions imply that there are no interactions with Active Directory. They also imply that there are no requirement for background jobs to capture the group side of changes on a periodic basis.

3. User-based interaction.

a. User authentication. User authentication workflow results in two interactions with Active Directory:

- Used to authenticate the user with the credentials provided.
- Add or update select user attributes to the XenMobile Server database, including objectGUID, Distinguished Name, sAMAccountName, and direct membership to groups. Changes to group membership result in the re-evaluation of the app, policy, and access entitlements.

The user can authenticate either from the device or from the XenMobile Server console. In both the scenarios, interaction with Active Directory adheres to the same behavior.

b. App Store access and refresh. A refresh of the store results in a refresh of user attributes, including direct group memberships. This action allows for a re-evaluation of user entitlements.

c. Device check-ins. Administrators can configure in the XenMobile console the device check-ins on a periodic basis. Every time a device is checked-in, the corresponding user attributes are refreshed, including direct group memberships. These check-ins allow for a re-evaluation of user entitlements.

d. OTP invitations by Group. The XenMobile Server administrator selects a group from the list of Active Directory groups present in the XenMobile Server database. User members, both direct and indirect (due to nesting), are retrieved from Active Directory and saved in XenMobile Server database. OTP invitations are sent to the user members identified in the preceding step.

e. OTP invitations by user. The administrator inputs a search text string within the XenMobile console. XenMobile Server queries Active Directory and returns user records that match the input text string. The administrator then selects the user to send the OTP invitation. XenMobile Server retrieves the user details from Active Directory and updates the same details in the database before sending out the invitation to the user.

Background interactions

One conclusion from inline communication with Active Directory is that group-based interactions are triggered upon select

changes to the XenMobile Server configuration. When there are no changes to the configuration, it implies that there are no interactions with Active Directory for groups.

This interaction requires background jobs that periodically sync with Active Directory and update relevant changes to the interested groups.

Following are the background jobs that interact with Active Directory.

1. **Group sync job.** The purpose of this job is to query Active Directory, one group at a time, on interested groups for changes to distinguished name or sAMAccountName attributes. The search query to Active Directory uses the objectGUID of the interested group to get the current values of distinguished name and sAMAccountName attributes. Changes in distinguished name or sAMAccountName values for interested groups are updated to the database.

Note

This job does not update user to group membership information.

2. **Nested group sync job.** This job updates changes in the nesting hierarchy of interested groups. XenMobile Server allows both direct and indirect members of an interested group to get entitlements. The direct membership of the users is updated during user-based inline interactions. Running in the background, this job tracks indirect memberships. Indirect memberships are when a user is a member of a group that is a member of an interested group.

This job gathers the list of Active Directory groups from XenMobile Server database. These groups are a part of either the deployment group or the RBAC definition. For each group in this list, XenMobile Server gets the members of the group. Members of a group are a list of distinguished names that represent both users and groups. XenMobile Server makes another query back to Active Directory to get only the user members of the interested group. The difference between the two lists gives only the group members for the interested group. Changes in member groups are updated to the database. The same process is repeated for all the groups in the hierarchy.

Changes to nesting results in processing the affected users for entitlement changes.

3. **Disabled user check.** This job runs only when the XenMobile administrator creates an action to check for disabled users. The job runs within the scope of a group sync job. The job queries Active Directory to check for the disabled status of interested users, one user at a time.

FAQ

XenMobile Deployment

Jun 21, 2017

There's a lot to consider when you're planning a XenMobile deployment. What devices should you choose? How should you manage them? How do you ensure that your network remains secure while still being user friendly? What hardware do you need in place and how do you troubleshoot it? This handbook aims to help answer those questions and more. Throughout the following pages, you'll find use cases and recommendations on topics that cover your deployment concerns, as well as questions you may have never thought to ask.

Keep in mind that a guideline or recommendation might not apply to all environments or use cases. Be sure to set up a test environment before going live with a XenMobile deployment.

The handbook has three main sections:

- **Assess:** Common use cases and questions to consider when planning your deployment.
- **Design & Configure:** Recommendations for designing and configuring your environment
- **Operate & Monitor:** Ensuring the smooth operation of your running environment.

Note

Some of the sections in this handbook apply to XenMobile on-premises deployments only and some to both on-premises and XenMobile Service (cloud) deployments. A note indicates which deployment applies to the content in each section.

Assess

As with any deployment, assessing your needs should be your first priority. What is your primary need for XenMobile? Do you need to manage every device in your environment or just the apps? Maybe you need to manage both. How secure do you need your XenMobile environment to be? Let's look at common use cases and questions for you to consider when planning your deployment.

- [Management modes](#)
- [Device requirements](#)
- [Security and user experience](#)
- [Apps](#)
- [User communities](#)
- [Email strategy](#)
- [XenMobile integration](#)
- [Multi-site requirements](#)

Design & Configure

Once you finish assessing your deployment needs, you can make decisions regarding the design and configuration of your environment. Choosing the hardware for your server, setting up policies for apps and devices, and getting users enrolled are just a few of the things you'll need to plan out. This section includes use cases and recommendations for each of these scenarios and more.

Note

The following articles in this section apply to XenMobile Service and XenMobile on-premises deployments.

- [Integrating with NetScaler and NetScaler Gateway](#)
- [SSO and proxy considerations for MDX apps](#)
- [Authentication](#)
- [Reference architecture for on-premises deployments](#)
- [Reference architecture for cloud deployments](#)
- [Server properties](#)
- [Device and app policies](#)
- [User enrollment options](#)
- [Tuning XenMobile operations](#)

Operate & Monitor

After your XenMobile environment is up and running, you'll want to monitor it to ensure smooth operation. The monitoring section discusses where you can find the various logs and messages XenMobile and its components generate, as well as how to read those logs. This section also includes a number of common troubleshooting steps you can follow to reduce customer support feedback time.

- [App provisioning and deprovisioning](#)
- [Dashboard-based operations](#)
- [Role-based Access Control and XenMobile support](#)
- [Systems monitoring](#)
- [Disaster recovery](#)
- [Citrix support process](#)

Management Modes

Jun 21, 2017

For each XenMobile instance (a single server or a cluster of nodes), you can choose whether to manage devices, apps, or both. XenMobile uses the following terms for device and app management modes, sometimes also referred to as deployment modes:

- Mobile device management mode (MDM mode)
- Mobile app management mode (MAM mode)
- MDM+MAM mode (Enterprise mode)

Note: This section applies to XenMobile Service and XenMobile on-premises deployments.

Mobile device management (MDM Mode)

With MDM, you can configure, secure, and support mobile devices. MDM enables you to protect devices and data on devices at a system level. You can configure policies, actions, and security functions. For example, you can wipe a device selectively if the device is lost, stolen, or out of compliance. Although app management is not available with MDM mode, you can deliver mobile apps, such as public app store and enterprise apps, in this mode. Following are common use cases for MDM mode:

- MDM is a consideration for corporate-owned devices where device-level management policies or restrictions, such as full wipe, selective wipe, or geo-location are required.
- When customers require management of an actual device, but do not require MDX policies, such as app containerization, controls on app data sharing, or micro VPN.
- When users only need email delivered to their native email clients on their mobile devices, and Exchange ActiveSync or Client Access Server is already externally accessible. In this use case, you can use MDM to configure email delivery.
- When you deploy native enterprise apps (non-MDX), public app store apps, or MDX apps delivered from public stores. Consider that an MDM solution alone might not prevent data leakage of confidential information between apps on the device. Data leakage might occur with copy and paste or Save As operations in Office 365 apps.

Mobile app management (MAM Mode)

MAM protects app data and lets you control app data sharing. MAM also allows for the management of corporate data and resources, separately from personal data. With XenMobile configured for MAM mode, you can use MDX-enabled mobile apps to provide per-app containerization and control. The term MAM mode is also called MAM-only mode. This term distinguishes this mode from a legacy MAM mode.

By leveraging MDX policies, XenMobile provides app-level control over network access (such as micro VPN), app and device interaction, data encryption, and app access.

MAM mode is often suitable for bring-your-own (BYO) devices because, although the device is unmanaged, corporate data remains protected. MDX has more than 50 MAM-only policies that you can set without needing an MDM control or relying on device passcodes for encryption.

MAM also supports the XenMobile Apps. This support includes secure email delivery to Citrix Secure Mail, data sharing between the secured XenMobile Apps, and secure data storage in ShareFile. For details, see [XenMobile Apps](#).

Note: Worx Mobile Apps are renamed to XenMobile Apps as of the 10.4 release. Most of the individual XenMobile Apps are

renamed as well. For details, see [About XenMobile Apps](#).

MAM is often suitable for the following examples:

- You deliver mobile apps, such as MDX apps, managed at the app level.
- You are not required to manage devices at a system level.

MDM+MAM (Enterprise Mode)

MDM+MAM is a hybrid mode, also called Enterprise Mode, which enables all feature sets available in the XenMobile Enterprise Mobility Management (EMM) solution. Configuring XenMobile with MDM+MAM mode enables both MDM and MAM features.

XenMobile lets you specify whether users can choose to opt out of device management or whether you require device management. This flexibility is useful for environments that include a mix of use cases. These environments may or may not require management of a device through MDM policies to access your MAM resources.

MDM+MAM is suitable for the following examples:

- You have a single use case in which both MDM and MAM are required. MDM is required to access your MAM resources.
- Some use cases require MDM while some do not.
- Some use cases require MAM while some do not.

You specify the management mode for XenMobile Server through the Server Mode property. You configure the setting in the XenMobile console. The mode can be MDM, MAM, or ENT (for MDM+MAM).

The XenMobile edition for which you have a license determines the management modes and other features available, as shown in the following table.

XenMobile MDM Edition	XenMobile Advanced Edition	XenMobile Enterprise Edition
MDM features only	MDM and MAM features	MDM and MAM features
Secure Hub	MDX Toolkit	MDX Toolkit
QuickEdit	XenMobile Apps: Secure Hub Secure Mail Secure Web QuickEdit Secure Tasks	XenMobile Apps: Secure Hub Secure Mail Secure Web QuickEdit Secure Tasks ShareConnect Secure Notes ShareFile Enterprise Edition

Device Management and MDM Enrollment

A XenMobile Enterprise environment can include a mixture of use cases, some of which require device management through MDM policies to allow access to MAM resources. Before deploying XenMobile Apps to users, fully assess your use cases and decide whether to require MDM enrollment. If you later decide to change the requirement for MDM enrollment, it is likely that users must re-enroll their devices.

Note: To specify whether you require users to enroll in MDM, use the XenMobile Server property **Enrollment Required** in the XenMobile console (**Settings > Server Properties**). That global server property applies to all users and devices for the XenMobile instance. The property applies only when the XenMobile Server Mode is ENT.

The following table summarizes some of the advantages and disadvantages (along with mitigations) of requiring MDM enrollment in a XenMobile Enterprise mode deployment.

MDM Enrollment	Advantages	Disadvantages and Mitigations
Is optional	<p>Users can access MAM resources without putting their devices under MDM management. This option can increase user adoption.</p> <p>Ability to secure access to MAM resources to protect enterprise data.</p> <p>MDX policies such as App Passcode can control app access for each MDX app.</p> <p>Configuring NetScaler, XenMobile Server, and per-application time-outs, along with Citrix PIN, provide an extra layer of protection.</p> <p>While MDM actions do not apply to the device, some MDX policies are available to deny MAM access. The denial would be based on system settings, such as jailbroken or rooted devices.</p> <p>Users can choose whether to enroll their device with MDM during first-time use.</p>	<p>MAM resources are available to devices not enrolled in MDM.</p> <p>MDM policies and actions are available only to MDM-enrolled devices.</p> <p>Mitigation options:</p> <p>Have users agree to a company terms and conditions that holds them responsible if they choose to go out of compliance. Have administrators monitor unmanaged devices.</p> <p>Manage application access and security by using application timers. Decreased time-out values increase security, but may affect user experience.</p> <p>A second XenMobile environment with MDM enrollment required is an option. When considering this option, keep in mind the additional overhead of managing two environments and the additional resources required.</p>
Is required	Ability to restrict access to MAM	Requires all users to enroll with MDM.

<p>resources only to MDM-managed devices.</p> <p>MDM policies and actions can apply to all devices in the environment as desired.</p> <p>Users are not able to opt out of enrolling their device.</p>	<p>Might decrease adoption for users who object to corporate management of their personal devices.</p> <p>Mitigation options:</p> <p>Educate users about what XenMobile actually manages on their devices and what information administrators can access.</p> <p>You can use a second XenMobile environment, with a Server Mode of MAM (also called MAM-only mode), for devices that don't need MDM management. When considering this option, keep in mind the additional overhead of managing two environments and the additional resources required.</p>
---	---

About MAM and Legacy MAM Modes

XenMobile 10.3.5 introduced a new MAM-only server mode. To distinguish the prior and new MAM modes, the documentation uses these terms. The new mode is called MAM-only or MA, the prior MAM mode is called legacy MAM mode.

MAM-only mode is in effect when the Server Mode property of XenMobile is MAM. Devices register in MAM mode.

Legacy MAM functionality is in effect when the Server Mode property of XenMobile is ENT and users choose to opt out of device management. In that case, devices register in MAM mode. Users who opt out of MDM management continue to receive the legacy MAM functionality.

Note: Previously, setting the Server Mode property to MAM had the same effect as setting it to ENT: Users who opted out of MDM management received the legacy MAM functionality.

The following table summarizes the Server Mode setting to use for a particular license type and desired device mode:

Your licenses are for this edition	You want devices to register in this mode	Set the Server Mode property to
Enterprise/ Advanced/MDM	MDM mode	MDM
Enterprise/Advanced	MAM mode (also called MAM-only mode)	MAM
Enterprise/Advanced	MDM+MAM mode	ENT Users who opt out of device management operate under the legacy MAM mode.

MAM-only mode supports the following features that were previously available only for ENT. These features are not available for Windows Phone.

- **Certificate-based authentication:** MAM-only mode supports certificate-based authentication. Users will experience continued access to their apps even when their Active Directory password expires. If you use certificate-based authentication for MAM devices, you must configure your NetScaler Gateway. By default, in **XenMobile Settings > NetScaler Gateway**, Deliver user certificate for authentication is set to **Off**, meaning that user name and password authentication is used. Change that setting to **On** to enable certificate authentication.
- **Self Help Portal:** To enable users to perform their own app lock and app wipe. Those actions apply to all apps on the device. You can configure the App Lock and App Wipe actions in **Configure > Actions**.
- **All enrollment modes:** Including High Security, Invitation URL, and Two Factor, configured through **Manage > Enrollment Invitations**.
- **Device registration limit for Android and iOS devices:** The Server Property **Number of Devices Per User** has moved to **Configure > Enrollment Profiles** and now applies to all server modes.
- **MAM-only APIs:** For MAM-only devices, you can call REST services by using any REST client and the XenMobile REST API to call services that the XenMobile console exposes.
- The MAM-only APIs enable you to:
 - Send an invitation URL and one-time PIN.
 - Issue app lock and wipe on devices.

The following table summarizes the differences between the legacy MAM and MAM-only functionality.

Enrollment Scenarios and Other Features	Legacy MAM (server mode is ENT)	MAM-only mode (server mode is MAM)
Certificate authentication	Not supported.	Supported. For certificate authentication, NetScaler Gateway is required.
Deployment requirement	XenMobile Server does not need to be directly accessible from devices.	XenMobile Server does not need to be directly accessible from devices.
Enrollment option	Use the NetScaler Gateway FQDN or, when using MDM FQDN, opt not to enroll.	Use XenMobile Server FQDN.
Enrollment methods*	User name + Password	User name + Password, High Security, Invitation URL, Invitation URL+PIN, Invitation URL + Password, Two Factor, User name + PIN
App lock and wipe	Supported.	Supported.

Self Help Portal options for app lock and wipe	Not supported.	Supported.
App wipe behavior	Apps remain on the device but are not usable. XenMobile deletes the account on the client only.	Apps remain on the device but are not usable. XenMobile deletes the account on the client only.
Automated actions for MAM-only users.	Event, device property, user property actions are supported. Doesn't support installed app-based automated actions.	Supports event, device property, user property, and some app-based actions, including app wipe and app lock.
Built-in action when an Active Directory user is deleted	Supports app wipe.	Supports app wipe.
Enrollment limit	Supported; configured through an enrollment profile.	Supported; configured through an enrollment profile.
Software inventory	Supported. XenMobile lists apps installed on a device	Not supported

***Regarding notifications:** SMTP is the only supported method for sending enrollment invitations.

Important: For MAM-only mode, previously enrolled users must re-enroll their devices. Be sure to provide users with the XenMobile Server FQDN they need for enrollment. In MAM-only mode, like the ENT mode, devices enroll using the XenMobile Server FQDN. (In the legacy MAM mode, devices enroll using the NetScaler Gateway FQDN.)

Device Requirements

Jun 21, 2017

Note

This section applies to XenMobile Service and XenMobile on-premises deployments.

An important point to consider for any deployment is the device you plan to roll out. On the iOS, Android, and Windows platforms, the options are numerous. For a list of devices that XenMobile supports, see [Supported device platforms](#).

In a bring your own device (BYOD) environment, a mixture of supported platforms is possible. Consider the limitations in the [Supported device platform](#) article, however, when informing users about the devices they can enroll. Even if you only allow one or two devices in your environment, XenMobile functions slightly differently on iOS, Android, and Windows devices. Different feature sets are available on each platform.

Also, not all app designs target both tablet and phone form factors. Before you make widespread changes, test the apps to ensure that they fit the device screen you want to roll out.

You can consider enrollment factors as well. Apple and Google offer enterprise enrollment programs. Through the [Apple Device Enrollment Program \(DEP\)](#) and [Google Android at Work](#), you can purchase devices that are preconfigured and ready for employees to use. Even when you don't use these programs, consider whether you want to send invitation links to your users through SMS. You cannot use SMS on tablets.

For more information about enrollment, see [User Enrollment Options](#).

Security and User Experience

Jun 21, 2017

Note

This section applies to XenMobile Service and XenMobile on-premises deployments.

Security is important to any organization, but you need to strike a balance between security and user experience. On one hand, you may have a very secure environment that is very difficult for users to use. On the other hand, your environment may be so user-friendly that access control is not as strict. The other sections in this virtual handbook cover security features in detail, but the purpose of this article is to give a general overview of the security options available to you and to get you thinking about common security concerns in XenMobile.

Here are some key considerations to keep in mind for each use case:

- Do you want to secure certain apps, the entire device, or both?
- How do you want your users to authenticate their identity? Will you be using LDAP, certificate-based authentication, or a combination of the two?
- How much time should pass before a user's session times out? Keep in mind that there are different time-out values for background services, NetScaler, and for being able to access apps while offline.
- Do you want users to set up a device-level passcode and/or an app-level passcode? How many logon attempts do you want to afford to users? Keep in mind the additional per-app authentication requirements that may be implemented with MAM and how users may perceive them.
- What other restrictions do you want to place on users? Should they be able to access cloud services such as Siri? What can they do with each app you make available to them and what can they not do? Should you deploy corporate WiFi policies to prevent cellular data plans from being eaten up while inside office spaces?

App vs. Device

One of the first things you should consider is whether you should only secure certain apps (mobile app management, or MAM) or if you want to manage the entire device (mobile device management or MDM). Most commonly, if you don't require device-level control, you'll only need to manage mobile apps, especially if your organization supports Bring Your Own Device (BYOD).

With a MAM-only environment, users can access resources made available to them. MAM policies secure and manage the apps themselves.

MDM allows you to secure an entire device, including the ability to take inventory of all the software on a device and prevent enrollment if the device is jailbroken, rooted, or has unsafe software installed. Taking this level of control, however, makes users leery of allowing that much power over their personal devices and may reduce enrollment rates.

It is possible to have MDM required for some devices and not for others, but keep in mind that this choice may involve setting up two dedicated environments, which requires additional resources and upkeep.

Authentication

Authentication is where a great deal of the user experience takes place. If your organization is already running Active Directory, using Active Directory is the simplest way to have your users access the system.

Another big part of the authentication user experience is time-outs. A high security environment may have users log on every time they access the system, but that option may not be ideal for all organizations. For example, having users enter their credentials every time they want to access their email can be very frustrating and may not be necessary.

User Entropy

For added security, you can enable a feature called *user entropy*. Citrix Secure Hub and some other apps often share common data like passwords, PINs, and certificates to ensure everything functions properly. This information is stored in a generic vault within Secure Hub. If you enable user entropy through the **Encrypt Secrets** option, XenMobile creates a new vault called UserEntropy, and moves the information from the generic vault into this new vault. In order for Secure Hub or another app to access the data, users must enter a password or PIN.

Enabling user entropy adds another layer of authentication in a number of places. This means, however, that whenever an app requires access to shared data in the UserEntropy vault—which includes passwords, PINs, and certificates—users need to enter a password or PIN.

You can learn more about user entropy by reading [About the MDX Toolkit](#) in the XenMobile documentation. To turn on user entropy, you can find the related settings in the [Client properties](#).

Policies

Both MDX and MDM policies give a great deal of flexibility to organizations, but they can also restrict users. You may want this in some situations, but policies may also make a system unusable. For instance, you may want to block access to cloud applications such as Siri or iCloud that have the potential to send sensitive data where you don't want it going. You can set up a policy to block access to these services, but keep in mind that such a policy may have unintended consequences. The iOS keyboard mic is also reliant on cloud access and you may block access to that feature as well.

Apps

Enterprise Mobility Management (EMM) segments into Mobile Device Management (MDM) and Mobile Application Management (MAM). While MDM enables organizations to secure and control mobile devices, MAM facilitates application delivery and management. With the increasing adoption of BYOD, you can typically implement a MAM solution, such as XenMobile, to assist with application delivery, software licensing, configuration, and application life cycle management. With XenMobile, you can go a step further to secure these apps by configuring specific MAM policies and VPN settings to prevent data leak and other security threats. XenMobile provides organizations with the flexibility to deploy their solution as a MAM-only or a MDM-only environment, or to implement XenMobile as a unified XenMobile Enterprise environment that provides both MDM and MAM functionality within in the same platform.

In addition to the ability to deliver apps to mobile devices, XenMobile offers app containerization through MDX technology. MDX secures apps through encryption that is separate from device level encryption; you can wipe or lock the app, and the apps are subject to granular policy-based controls. Independent software vendors (ISVs) can apply these controls using the Worx App SDK.

In a corporate environment, users use a variety of mobile apps to aid in their job role. The apps can include apps from the public app store, in-house developed apps, or native apps as well, in some cases. XenMobile categorizes these apps as follows:

Public apps: These apps include free or paid apps available in a public app store, such as iTunes or Google Play. Vendors outside of the organization often make their apps available in public app stores. This option lets their customers download the apps directly from the Internet. You may use numerous public apps in your organization depending on users' needs. Examples of such apps include GoToMeeting, Salesforce, and EpicCare apps.

Citrix does not support downloading app binaries directly from public app stores, and then wrapping them with the MDX Toolkit for enterprise distribution. If you need to wrap third-party applications, work with your app vendor to obtain the app binaries which you can wrap using the MDX Toolkit.

In-house apps: Many organizations have in-house developers who create apps that provide specific functionality and are independently developed and distributed within the organization. In certain cases, some organizations may also have apps that ISVs provide. You can deploy such apps as native apps or you can containerize the apps by using a MAM solution, such as XenMobile. For example, a healthcare organization may create an in-house app that allows physicians to view patient information on mobile devices. An organization can then use the MDX Toolkit to wrap the app in order to secure patient information and enable VPN access to the back-end patient database server.

Web and SaaS apps: These apps include apps accessed from an internal network (web apps) or over a public network (SaaS). XenMobile also allows you to create custom web and SaaS apps using a list of app connectors. These app connectors can facilitate single sign-on (SSO) to existing Web apps. For details, see [App connector types](#). For example, you can use Google Apps SAML for SSO based on Security Assertion Markup Language (SAML) to Google Apps.

XenMobile Apps: These are Citrix-developed apps that are included with the XenMobile license. For details, see [About XenMobile Apps](#). Citrix also offers other [business-ready apps](#) that ISVs develop by using the Worx App SDK.

HDX apps: These are Windows-hosted apps that you publish with StoreFront. If you have a Citrix XenApp and XenDesktop environment, you can integrate the apps with XenMobile to make the apps available to the enrolled users.

Depending on the type of mobile apps you plan to deploy and manage with XenMobile, the underlying configuration and architecture will differ. For example, if multiple groups of users with different levels of permissions will consume a single app, you may have to create separate delivery groups to deploy two separate versions of the same app. In addition, you must make sure the user group membership is mutually exclusive to avoid policy mismatches on users' devices.

You may also want to manage iOS application licensing by using the Apple Volume Purchase Program (VPP). This option will require you to register for the VPP program and configure XenMobile VPP settings in the XenMobile console to distribute the apps with the VPP licenses. A variety of such use cases makes it important to assess and plan your MAM strategy prior to implementing the XenMobile environment. You can start planning your MAM strategy by defining the following:

Types of apps: List the different types of apps you plan to support and categorize them, such as public, native, XenMobile Apps, Web, in-house, ISV apps, and so on. Also, categorize the apps for different device platforms, such as iOS and Android. This categorization will help with aligning different XenMobile settings that are required for each type of app. For example, certain apps may not qualify for wrapping, or a few apps may require the use of the Worx App SDK to enable special APIs

for interaction with other apps.

Network requirements: You need to configure apps with specific network access requirements with the appropriate settings. For example, certain apps may need access to your internal network through VPN; some apps may require Internet access to route access via the DMZ. In order to allow such apps to connect to the required network, you have to configure various settings accordingly. Defining per-app network requirements help in finalizing your architectural decisions early on, which will streamline the overall implementation process.

Security requirements: Defining the security requirements that apply to either individual apps or all the apps is critical to ensure that you create the right configurations when you install XenMobile server. Although settings, such as the MDX policies, apply to individual apps, session and authentication settings apply across all apps, and some apps may have specific encryption, containerization, wrapping, encryption, authentication, geo fencing, passcode or data sharing requirements that you will need to outline in advance to simplify your deployment.

Deployment requirements: You may want to use a policy-based deployment to allow only compliant users to download the published apps. For example, you may want certain apps to require that device encryption is enabled or the device is managed, or that the device meets a minimum operating system version. You may also want certain apps to be available only to corporate users. You need to outline such requirements in advance so that you can configure the appropriate deployment rules or actions.

Licensing requirements: You should record app-related licensing requirements. These notes will help you to manage license usage effectively and to decide if you need to configure specific features in XenMobile to facilitate licensing. For example, if you deploy an iOS app, irrespective of whether it is a free or a paid app, Apple enforces licensing requirements on the app by making the users sign into their iTunes account. You can register for Apple VPP to distribute and manage these apps via XenMobile. VPP allows users to download the apps without having to sign into their iTunes account. Additionally, tools, such as Samsung SAFE and Samsung KNOX, have special licensing requirements, which you need to complete prior to deploying those features.

Blacklist/whitelist requirements: There may be apps that you do not want users to install or use at all. Creating a blacklist will define an out of compliance event. You can then set up policies to trigger in case such a thing happens. On the other hand, an app may be acceptable for use but may fall under the blacklist for one reason or another. If this is the case, you can add the app to a whitelist and indicate that the app is acceptable to use but is not required. Also, keep in mind that the apps pre-installed on new devices can include some commonly used apps that are not part of the operating system. This may conflict with your blacklisting strategy.

Use Case

A healthcare organization plans to deploy XenMobile to serve as a MAM solution for their mobile apps. Mobile apps are delivered to corporate and BYOD users. IT decides to deliver and manage the following apps:

- **XenMobile Apps:** iOS and Android apps provided by Citrix.
- **Secure Mail:** Email, calendar, and contact app.
- **Secure Web:** Secure web browser that provides access to the Internet and intranet sites.
- **Secure Notes:** Secure note-taking app with email and calendar integration.
- **ShareFile:** App to access shared data and to share, sync, and edit files.

Public app store:

- **Secure Hub:** Client used by all mobile devices to communicate with XenMobile. IT pushes security settings, configurations, and mobile apps to mobile devices via the Secure Hub client. Android and iOS devices enroll in XenMobile through Secure Hub.
- **Citrix Receiver:** Mobile app that allows users to open XenApp-hosted applications on mobile devices.
- **GoToMeeting:** An online meeting, desktop sharing, and video conferencing client that lets users meet with other computer users, customers, clients, or colleagues via the Internet in real time.
- **SalesForce1:** Salesforce1 lets users access Salesforce from mobile devices and brings all Chatter, CRM, custom apps, and business processes together in a unified experience for any Salesforce user.
- **RSA SecurID:** Software-based token for two-factor authentication.
- **EpicCare apps:** These apps give healthcare practitioners secure and portable access to patient charts, patient lists, schedules, and messaging.
 - **Haiku:** Mobile app for the iPhone and Android phones.
 - **Canto:** Mobile app for the iPad
 - **Rover:** Mobile apps for iPhone and iPad.

HDX: These apps are delivered via Citrix XenApp.

- **Epic Hyperspace:** Epic client application for electronic health record management.

ISV:

- **Vocera:** HIPAA compliant voice-over IP and messaging mobile app that extends the benefits of Vocera voice technology anytime, anywhere via iPhone and Android smartphones.

In-house apps:

- **HCMail:** App that helps compose encrypted messages, search address books on internal mail servers, and send the encrypted messages to the contacts using an email client.

In-house web apps:

- **Patient Rounding:** Web application used to record patient health information by different departments.
- **Outlook Web Access:** Allows the access of email via a web browser.
- **SharePoint:** Used for organization-wide file and data sharing.

The following table lists the basic information required for MAM configuration.

App Name	App Type	MDX Wrapping	iOS	Android
Secure Mail	XenMobile App	No for version 10.4.1 and later	Yes	Yes
Secure Web	XenMobile App	No for version 10.4.1 and later	Yes	Yes
Secure Notes	XenMobile App	No for version 10.4.1 and later	Yes	Yes

ShareFile	XenMobile App	No for version 10.4.1 and later	Yes	Yes
Secure Hub	Public App	NA	Yes	Yes
Citrix Receiver	Public App	NA	Yes	Yes
GoToMeeting	Public App	NA	Yes	Yes
SalesForce1	Public App	NA	Yes	Yes
RSA SecurID	Public App	NA	Yes	Yes
Epic Haiku	Public App	NA	Yes	Yes
Epic Canto	Public App	NA	Yes	No
Epic Rover	Public App	NA	Yes	No
Epic Hyperspace	HDX App	NA	Yes	Yes
Vocera	ISV App	Yes	Yes	Yes
HCMail	In-House App	Yes	Yes	Yes
PatientRounding	Web App	NA	Yes	Yes
Outlook Web Access	Web App	NA	Yes	Yes
SharePoint	Web App	NA	Yes	Yes

The following tables list specific requirements you can consult when configuring MAM policies in XenMobile.

App Name	VPN Required	Interaction (with apps outside of container)	Interaction (from apps outside of container)	Device Encryption
Secure Mail	Y	Selectively Allowed	Allowed	Not required

Secure Web	Y	Allowed	Allowed	Not required
Secure Notes	Y	Allowed	Allowed	Not required
ShareFile	Y	Allowed	Allowed	Not required
Secure Hub	Y	N/A	N/A	N/A
Citrix Receiver	Y	N/A	N/A	N/A
GoToMeeting	N	N/A	N/A	N/A
SalesForce1	N	N/A	N/A	N/A
RSA SecurID	N	N/A	N/A	N/A
Epic Haiku	Y	N/A	N/A	N/A
Epic Canto	Y	N/A	N/A	N/A
Epic Rover	Y	N/A	N/A	N/A
Epic Hyperspace	Y	N/A	N/A	N/A
Vocera	Y	Disallowed	Disallowed	Not required
HCMail	Y	Disallowed	Disallowed	Required
PatientRound-ing	Y	N/A	N/A	Required
Outlook Web Access	Y	N/A	N/A	Not required
SharePoint	Y	N/A	N/A	Not required

App Name	Proxy Filtering	Licensing	Geo-fencing	Worx App SDK	Minimum Operating System Version
-----------------	------------------------	------------------	--------------------	---------------------	---

Secure Mail	Required	N/A	Selectively Required	N/A	Enforced
Secure Web	Required	N/A	Not required	N/A	Enforced
Secure Notes	Required	N/A	Not required	N/A	Enforced
ShareFile	Required	N/A	Not required	N/A	Enforced
Secure Hub	Not required	VPP	Not required	N/A	Not enforced
Citrix Receiver	Not required	VPP	Not required	N/A	Not enforced
GoToMeeting	Not required	VPP	Not required	N/A	Not enforced
SalesForce1	Not required	VPP	Not required	N/A	Not enforced
RSA SecurID	Not required	VPP	Not required	N/A	Not enforced
Epic Haiku	Not required	VPP	Not required	N/A	Not enforced
Epic Canto	Not required	VPP	Not required	N/A	Not enforced
Epic Rover	Not required	VPP	Not required	N/A	Not enforced
Epic Hyperspace	Not required	N/A	Not required	N/A	Not enforced
Vocera	Required	N/A	Required	Required	Enforced
HCMail	Required	N/A	Required	Required	Enforced
PatientRound-ing	Required	N/A	Not required	N/A	Not enforced
Outlook Web Access	Required	N/A	Not required	N/A	Not enforced
SharePoint	Required	N/A	Not required	N/A	Not enforced

User Communities

Every organization consists of diverse user communities that operate in different functional roles. These user communities perform different tasks and office functions using various resources that you provide through the users' mobile devices. Users may work from home or in remote offices using mobile devices that you provide, or using their personal mobile devices, which allows them to access tools that are subject to certain security compliance rules.

As more and more user communities start using mobile devices to either simplify or aid in their job role, Enterprise Mobility Management (EMM) becomes critical to prevent data leak and to enforce an organization's security restrictions. In order for efficient and more sophisticated mobile device management, you can categorize your user communities. Doing so simplifies the mapping of users to resources and ensures that the right security policies apply to the right users.

The following example illustrates how the user communities of a healthcare organization are classified for EMM.

Use Case

This example healthcare organization provides technology resources and access to multiple users, including network and affiliate employees and volunteers. The organization has chosen to roll out the EMM solution to non-executive users only.

User roles and functions for this organization can be broken into subgroups including: clinical, non-clinical, and contractors. A selected set of users receive corporate mobile devices, while others can access limited company resources from their personal devices. In order to enforce the right level of security restrictions and prevent data leak, the organization decided that corporate IT manages each enrolled device, Corporate and Bring Your Own Device (BYOD). Additionally, users can only enroll a single device.

The following section provides an overview of the roles and functions of each subgroup:

Clinical:

- Nurses
- Physicians (Doctors, Surgeons, and so on)
- Specialists (Dietitians, phlebotomists, anesthesiologists, radiologists, cardiologists, oncologists, and so on)
- Outside physicians (Non-employee physicians and office workers that work from remote offices)
- Home Health Services (Office and mobile workers performing physician services for patient home visits)
- Research Specialist (Knowledge Workers and Power Users at six Research Institutes performing clinical research to find answers to issues in medicine)
- Education and Training (Nurses, physicians, and specialists in education and training)

Non-Clinical:

- Shared Services (Office workers performing various back office functions including: HR, Payroll, Accounts Payable, Supply Chain Service, and so on)
- Physician Services (Office workers performing a variety of health care management, administrative services, and business process solutions to providers, including: Administrative Services, Analytics and Business Intelligence, Business Systems, Client Services, Finance, Managed Care Administration, Patient Access Solutions, Revenue Cycle Solutions, and so on)
- Support Services (Office workers performing a variety of non-clinical functions including: Benefits Administration, Clinical Integration, Communications, Compensation & Performance Management, Facility & Property Services, HR Technology

Systems, Information Services, Internal Audit & Process Improvement, and so o.)

- Philanthropic Programs (Office and mobile workers that perform various functions in support of philanthropic programs)

Contractors:

- Manufacturer and vendor partners (Onsite and remotely connected via site-to-site VPN providing various non-clinical support functions)

Based on the preceding information, the organization created the following entities. For more information about delivery groups in XenMobile, see [Deploy resources](#) in the XenMobile product documentation.

Active Directory Organizational Units (OUs) and Groups

OU	OU	Groups
XenMobile Resources	Clinical	XM-Nurses
		XM-Physicians
		XM-Specialists
		XM-Outside Physicians
		XM-Home Health Services
		XM-Research Specialist
		XM-Education and Training
	Non-Clinical	XM-Shared Services
		XM-Physician Services
		XM-Support Services
		XM-Philanthropic Programs

XenMobile Local Users and Groups

Group	Users
Contractors	Vendor1

	Vendor2
	Vendor3
	Vendor4
	Vendor5
	Vendor6
	Vendor7
	Vendor8
	Vendor9
	Vendor10

XenMobile Delivery Groups

Clinical-Nurses
Clinical-Physicians
Clinical-Specialists
Clinical-Outside Physicians
Clinical-Home Health Services
Clinical-Research Specialist
Clinical-Education and Training
Non-Clinical-Shared Services
Non-Clinical-Physician Services

Non-Clinical-Support Services
Non-Clinical-Philanthropic Programs

Delivery Group and User Group mapping

Active Directory Groups	XenMobile Delivery Groups
XM-Nurses	Clinical-Nurses
XM-Physicians	Clinical-Physicians
XM-Specialists	Clinical-Specialists
XM-Outside Physicians	Clinical-Outside Physicians
XM-Home Health Services	Clinical-Home Health Services
XM-Research Specialist	Clinical-Research Specialist
XM-Education and Training	Clinical-Education and Training
XM-Shared Services	Non-Clinical-Shared Services
XM-Physician Services	Non-Clinical-Physician Services
XM-Support Services	Non-Clinical-Support Services
XM-Philanthropic Programs	Non-Clinical-Philanthropic Programs

Delivery Group and Resource mapping

The following tables illustrate the resources assigned to each delivery group in this use case. The first table shows the mobile app assignments; the second table shows the public app, HDX apps, and device management resources.

XenMobile Delivery Groups	Mobile Apps	Mobile Apps	
	Citrix Apps	Public Apps	HDX Apps

Clinical-Nurses	X	X	X	X						
Clinical-Physicians										
Clinical-Specialists										
Clinical-Outside Physicians	X		X	X						
Clinical-Home Health Services	X		X	X						
Clinical-Research Specialist	X		X	X						
Clinical-Education and Training								X	X	
Non-Clinical-Shared Services								X	X	
Non-Clinical-Physician Services								X	X	
Non-Clinical-Support Services	X		X	X				X	X	
Non-Clinical-Philanthropic Programs	X		X	X				X	X	

Contractors	X		X	X	X	X		X	X	
-------------	---	--	---	---	---	---	--	---	---	--

XenMobile Delivery Groups	Mobile Apps			Device Management			
	Public Apps		HDX Apps	Passcode Policy	Device Restrictions	Automated Actions	WiFi Policy
	RSA SecurID	EpicCare Haiku	Epic Hyperspace				
Clinical-Nurses							X
Clinical-Physicians					X		
Clinical-Specialists							
Clinical-Outside Physicians							
Clinical-Home Health Services							
Clinical-Research Specialist							
Clinical-Education and Training		X	X				
Non-Clinical-Shared Services		X	X				
Non-Clinical-Physician Services		X	X				
Non-Clinical-Support Services		X	X				

Notes and considerations:

- XenMobile creates a default delivery group named All Users during the initial configuration. If you do not disable this Delivery Group, all Active Directory users will have rights to enroll into XenMobile.
- XenMobile synchronizes Active Directory users and groups on demand using a dynamic connection to the LDAP server.
- If a user is part of a group that is not mapped in XenMobile, that user cannot enroll. Likewise, if a user is a member of multiple groups, XenMobile will only categorize the user as being in the groups mapped to XenMobile.
- In order to make MDM enrollment mandatory, you must set the Enrollment Required option to True in Server Properties in the XenMobile console. For details, see [Server Properties](#).
- You can delete a user group from a XenMobile delivery group by deleting the entry in the SQL Server database, under `dbo.userlistgrps`.

Caution: Before you perform this action, create a backup of XenMobile and the database.

About Device Ownership in XenMobile

You can group users according to the owner of a users' device. Device ownership includes corporate-owned devices and user-owned devices, also known as bring your own device (BYOD). You can control how BYOD devices connect to your network in two places in the XenMobile console: in Deployment Rules and through XenMobile server properties on the Settings page. For details about deployment rules, see [Configuring Deployment Rules](#) in the XenMobile documentation. For details about server properties, see [Server Properties](#).

By setting server properties, you can require all BYOD users to accept corporate management of their devices before they can access apps, or you can give users access to corporate apps without also managing their devices.

When you set the server setting **wsapi.mdm.required.flag** to **true**, XenMobile manages all BYOD devices, and any user who declines enrollment is denied access to apps. You should consider setting **wsapi.mdm.required.flag** to **true** in environments in which enterprise IT teams need high security along with a positive user experience, which comes from enrolling user devices in XenMobile.

If you leave **wsapi.mdm.required.flag** as **false**, which is the default setting, users can decline enrollment, but may still access apps on their devices through the XenMobile Store. You should consider setting **wsapi.mdm.required.flag** to **false** in environments in which privacy, legal, or regulatory constraints require no device management, only enterprise app management.

Users with devices that XenMobile doesn't manage can install apps through the XenMobile Store. Instead of device-level controls, such as selective or full wipe, you control access to the apps through app policies. The policies, depending on the values you set, require the device to check the XenMobile server routinely to confirm that the apps are still allowed to run.

Security Requirements

The amount of security considerations when deploying a XenMobile environment can quickly become overwhelming. There are many interlocking pieces and settings, that you may not know where to begin or what to choose to ensure an acceptable level of protection is available. To make these choices simpler, Citrix provides recommendations for High, Higher, and Highest Security, as outlined in the following table.

Note that security concerns alone should not dictate your deployment mode choice. It is important to also review the requirements of the use case and decide if you can mitigate security concerns before choosing your deployment mode.

High: Using these settings provides an optimal user experience while maintaining a basic level of security acceptable to most organizations.

Higher: These settings strike a stronger balance between security and usability.

Highest: Following these recommendations will provide a very high level of security at the cost of usability and user adoption.

Security Considerations	High Security	Higher Security	Highest Security	Notes
Deployment Mode	MAM and/or MDM	MDM+MAM	MDM+MAM FIPS	<p>Depending on the use case, a MDM-only or MAM-only deployment could meet security requirements and provide a good user experience.</p> <p>If there is no need for app containerization, micro VPN or app specific policies, MDM should be sufficient to manage and secure devices.</p> <p>For use cases like BYOD in which all business and security requirements may be satisfied with app containerization only, Citrix recommends MAM-only mode.</p> <p>For high security environments (and corporate issued devices), Citrix recommends MDM+MAM to take advantage of all security capabilities available. You should enforce MDM enrollment through a server property in the XenMobile console.</p> <p>FIPS options for environments with the highest security needs, such as the federal government.</p> <p>Note: If you enable FIPS mode, you must configure SQL Server to encrypt SQL traffic.</p>
NetScaler and NetScaler Gateway	NetScaler is recommended NetScaler Gateway is required for MAM and ENT; recommended for MDM	Standard NetScaler for XenMobile wizard configuration with SSL bridge if XenMobile is in the DMZ; or SSL	SSL Offload with end-to-end encryption	<p>Exposing XenMobile server to the Internet via NAT or existing third-party proxies/load-balancers could be an option for MDM as long as the SSL traffic terminates on XenMobile server, but this choice poses a potential security risk.</p> <p>For high security environments, NetScaler with the default XenMobile configuration should meet or exceed security requirements.</p>

		offload if required to meet security standards when XenMobile server is in the internal network.		<p>For MDM environments with the highest security needs, SSL termination at the NetScaler provides the ability to inspect traffic at the perimeter, while maintaining end-to-end SSL encryption.</p> <ul style="list-style-type: none"> Options to define SSL/TLS ciphers. SSL FIPS NetScaler hardware is also available. <p>For more information, see Integrating with NetScaler Gateway and NetScaler in this virtual handbook.</p>
Enrollment	<p>Active Directory Group membership only</p> <p>All users Delivery Group disabled</p>	<p>Invitation only enrollment mode</p> <p>Active Directory Group membership only</p> <p>All users Delivery Group disabled</p>	<p>Enrollment mode tied to Device ID</p> <p>Active Directory Group membership only</p> <p>All users Delivery Group disabled</p>	<p>Citrix generally recommends that you restrict enrollment to users in predefined Active Directory groups only. This requires disabling the built-in All users Delivery Group.</p> <p>You can use enrollment invitations to restrict enrollment to users with an invitation only.</p> <p>You can use one-time PIN (OTP) enrollment invites as a two-factor solution and to control the number of devices a user may enroll.</p> <p>For environments with the highest security requirements, you can tie enrollment invitations to a device by SN/UDID/EMEI. A two-factor option is also available to require Active Directory password and OTP. (Note that OTP is not currently an option for Windows devices.)</p>
Device PIN	<p>Recommended</p> <p>*Required for Device level encryption</p> <p>May be enforced with MDM</p> <p>Can be set as required for MAM-only via an MDX policy</p>	<p>Enforced via MDM and/or MDX policy</p>	<p>Enforced via MDM and MDX policy</p> <p>MDM Complex passcode policy</p>	<p>Citrix recommends the use of a device PIN.</p> <p>You can enforce a device PIN via an MDM policy.</p> <p>You can use an MDX policy to make a device PIN a requirement for using managed apps; for example, for BYOD use cases.</p> <p>Citrix recommends combining the MDM and MDX policy options for increased security in MDM+MAM environments.</p> <p>For environments with the highest security requirements, you can configure complex passcode policies and enforced them with MDM. You can configure automatic actions to</p>

				notify administrators or issue selective/full device wipes when a device doesn't comply with a passcode policy.
--	--	--	--	---

Apps

Jun 21, 2017

Enterprise Mobility Management (EMM) segments into Mobile Device Management (MDM) and Mobile Application Management (MAM). While MDM enables organizations to secure and control mobile devices, MAM facilitates application delivery and management. With the increasing adoption of BYOD, you can typically implement a MAM solution, such as XenMobile, to assist with application delivery, software licensing, configuration, and application life cycle management.

With XenMobile, you can go a step further to secure these apps by configuring specific MAM policies and VPN settings to prevent data leak and other security threats. XenMobile provides organizations with the flexibility to deploy their solution as a MAM-only or a MDM-only environment, or to implement XenMobile as a unified XenMobile Enterprise environment that provides both MDM and MAM functionality within in the same platform.

In addition to the ability to deliver apps to mobile devices, XenMobile offers app containerization through MDX technology. MDX secures apps through encryption that is separate from device level encryption; you can wipe or lock the app, and the apps are subject to granular policy-based controls. Independent software vendors (ISVs) can apply these controls using the Worx App SDK.

In a corporate environment, users use a variety of mobile apps to aid in their job role. The apps can include apps from the public app store, in-house developed apps, or native apps as well, in some cases. XenMobile categorizes these apps as follows:

- **Public apps:** These apps include free or paid apps available in a public app store, such as iTunes or Google Play. Vendors outside of the organization often make their apps available in public app stores. This option lets their customers download the apps directly from the Internet. You may use numerous public apps in your organization depending on users' needs. Examples of such apps include GoToMeeting, Salesforce, and EpicCare apps.

Citrix does not support downloading app binaries directly from public app stores, and then wrapping them with the MDX Toolkit for enterprise distribution. If you need to wrap third-party applications, work with your app vendor to obtain the app binaries which you can wrap using the MDX Toolkit.

- **In-house apps:** Many organizations have in-house developers who create apps that provide specific functionality and are independently developed and distributed within the organization. In certain cases, some organizations may also have apps that ISVs provide. You can deploy such apps as native apps or you can containerize the apps by using a MAM solution, such as XenMobile. For example, a healthcare organization may create an in-house app that allows physicians to view patient information on mobile devices. An organization can then use the MDX Toolkit to wrap the app in order to secure patient information and enable VPN access to the back-end patient database server.
- **Web and SaaS apps:** These apps include apps accessed from an internal network (web apps) or over a public network (SaaS). XenMobile also allows you to create custom web and SaaS apps using a list of app connectors. These app connectors can facilitate single sign-on (SSO) to existing Web apps. For details, see [App connector types](#). For example, you can use Google Apps SAML for SSO based on Security Assertion Markup Language (SAML) to Google Apps.
- **Citrix XenMobile Apps:** These are Citrix-developed apps that are included with the XenMobile license. For details, see [About XenMobile Apps](#). Citrix also offers other [business-ready apps](#) that ISVs develop by using the Worx App SDK.
- **HDX apps:** These are Windows-hosted apps that you publish with StoreFront. If you have a Citrix XenApp and XenDesktop environment, you can integrate the apps with XenMobile to make the apps available to the enrolled users.

Depending of the type of mobile apps you plan to deploy and manage with XenMobile, the underlying configuration and architecture will differ. For example, if multiple groups of users with different level of permissions will consume a single app, you may have to create separate delivery groups to deploy two separate versions of the same app. In addition, you must make sure the user group membership is mutually exclusive to avoid policy mismatches on users' devices.

You may also want to manage iOS application licensing by using the Apple Volume Purchase Program (VPP). This option will require you to register for the VPP program and configure XenMobile VPP settings in the XenMobile console to distribute the apps with the VPP licenses. A variety of such use cases makes it important to assess and plan your MAM strategy prior to implementing the XenMobile environment. You can start planning your MAM strategy by defining the following:

- **Types of apps** - List the different types of apps you plan to support and categorize them, such as public, native, Worx, Web, in-house, ISV apps, and so on. Also, categorize the apps for different device platforms, such as iOS and Android. This categorization will help with aligning different XenMobile settings that are required for each type of app. For example, certain apps may not qualify for wrapping, or a few apps may require the use of the Worx App SDK to enable special APIs for interaction with other apps.
- **Network requirements** - You need to configure apps with specific network access requirements with the appropriate settings. For example, certain apps may need access to your internal network through VPN; some apps may require Internet access to route access via the DMZ. In order to allow such apps to connect to the required network, you have to configure various settings accordingly. Defining per-app network requirements help in finalizing your architectural decisions early on, which will streamline the overall implementation process.
- **Security requirements** - Defining the security requirements that apply to either individual apps or all the apps is critical to ensure that you create the right configurations when you install XenMobile server. Although settings, such as the MDX policies, apply to individual apps, session and authentication settings apply across all apps, and some apps may have specific encryption, containerization, wrapping, encryption, authentication, geo fencing, passcode or data sharing requirements that you will need to outline in advance to simplify your deployment. For details on security in XenMobile, see [Security and User Experience](#).
- **Deployment requirements** - You may want to use a policy-based deployment to allow only compliant users to download the published apps. For example, you may want certain apps to require that device encryption is enabled or the device is managed, or that the device meets a minimum operating system version. You may also want certain apps to be available only to corporate users. You need to outline such requirements in advance so that you can configure the appropriate deployment rules or actions.
- **Licensing requirements** - You should record app-related licensing requirements. These notes will help you to manage license usage effectively and to decide if you need to configure specific features in XenMobile to facilitate licensing. For example, if you deploy an iOS app, irrespective of whether it is a free or a paid app, Apple enforces licensing requirements on the app by making the users sign into their iTunes account. You can register for Apple VPP to distribute and manage these apps via XenMobile. VPP allows users to download the apps without having to sign into their iTunes account. Additionally, tools, such as Samsung SAFE and Samsung KNOX, have special licensing requirements, which you need to complete prior to deploying those features.
- **Blacklist/whitelist requirements** - There may be apps that you do not want users to install or use at all. Creating a blacklist will define an out of compliance event. You can then set up policies to trigger in case such a thing happens. On the other hand, an app may be acceptable for use but may fall under the blacklist for one reason or another. If this is the case, you can add the app to a whitelist and indicate that the app is acceptable to use but is not required. Also, keep in mind that the apps pre-installed on new devices can include some commonly used apps that are not part of the operating system. This may conflict with your blacklisting strategy.

Use Case

A healthcare organization plans to deploy XenMobile to serve as a MAM solution for their mobile apps. Mobile apps are delivered to corporate and BYOD users. IT decides to deliver and manage the following apps:

XenMobile Apps: iOS and Android apps provided by Citrix. For details, see [XenMobile Apps](#).

Citrix Secure Hub: Client used by all mobile devices to communicate with XenMobile. IT pushes security settings, configurations, and mobile apps to mobile devices via Secure Hub. Android and iOS devices enroll in XenMobile through Secure Hub.

Citrix Receiver: Mobile app that allows users to open XenApp-hosted applications on mobile devices.

GoToMeeting: An online meeting, desktop sharing, and video conferencing client that lets users meet with other computer users, customers, clients, or colleagues via the Internet in real time.

SalesForce1: Salesforce1 lets users access Salesforce from mobile devices and brings all Chatter, CRM, custom apps, and business processes together in a unified experience for any Salesforce user.

RSA SecurID: Software-based token for two-factor authentication.

EpicCare apps: These apps give healthcare practitioners secure and portable access to patient charts, patient lists, schedules, and messaging.

Haiku: Mobile app for the iPhone and Android phones.

Canto: Mobile app for the iPad

Rover: Mobile apps for iPhone and iPad.

HDX: These apps are delivered via Citrix XenApp.

- **Epic Hyperspace:** Epic client application for electronic health record management.

ISV:

- **Vocera:** HIPAA compliant voice-over IP and messaging mobile app that extends the benefits of Vocera voice technology anytime, anywhere via iPhone and Android smartphones.

In-house apps:

- **HCMail:** App that helps compose encrypted messages, search address books on internal mail servers, and send the encrypted messages to the contacts using an email client.

In-house web apps:

- **Patient Rounding:** Web application used to record patient health information by different departments.
- **Outlook Web Access:** Allows the access of email via a web browser.
- **SharePoint:** Used for organization-wide file and data sharing.

The following table lists the basic information required for MAM configuration.

App Name	App Type	MDX Wrapping	iOS	Android
Secure Mail	XenMobile App	No for version 10.4.1 and later	Yes	Yes
Secure Web	XenMobile App	No for version 10.4.1 and later	Yes	Yes
Secure Notes	XenMobile App	No for version 10.4.1 and later	Yes	Yes
ShareFile	XenMobile App	No for version 10.4.1 and later	Yes	Yes
Secure Hub	Public App	N/A	Yes	Yes
Citrix Receiver	Public App	N/A	Yes	Yes
GoToMeeting	Public App	N/A	Yes	Yes
SalesForce1	Public App	N/A	Yes	Yes
RSA SecurID	Public App	N/A	Yes	Yes
Epic Haiku	Public App	N/A	Yes	Yes
Epic Canto	Public App	N/A	Yes	No

Epic Rover	Public App	N/A	Yes	No
Epic Hyperspace	HDX App	N/A	Yes	Yes
Vocera	ISV App	Yes	Yes	Yes
HCMail	In-House App	Yes	Yes	Yes
PatientRounding	Web App	N/A	Yes	Yes
Outlook Web Access	Web App	N/A	Yes	Yes
SharePoint	Web App	N/A	Yes	Yes

The following table lists specific requirements you can consult configuring MAM policies in XenMobile.

App Name	VPN Required	Interaction (with apps outside of container)	Interaction (from apps outside of container)	Device Encryption	Proxy Filtering	Licensing	Geo-fencing	Worx App SDK	Minimum Operating System Version
Secure Mail	Y	Selectively Allowed	Allowed	Not required	Required	N/A	Selectively Required	N/A	Enforced
Secure Web	Y	Allowed	Allowed	Not required	Required	N/A	Not required	N/A	Enforced
Secure Notes	Y	Allowed	Allowed	Not required	Required	N/A	Not required	N/A	Enforced
ShareFile	Y	Allowed	Allowed	Not required	Required	N/A	Not required	N/A	Enforced
Secure Hub	Y	N/A	N/A	N/A	Not required	VPP	Not required	N/A	Not enforced
Citrix Receiver	Y	N/A	N/A	N/A	Not required	VPP	Not required	N/A	Not enforced
GoToMeeting	N	N/A	N/A	N/A	Not required	VPP	Not required	N/A	Not enforced
SalesForce1	N	N/A	N/A	N/A	Not	VPP	Not	N/A	Not

					required		required		enforced
RSA SecurID	N	N/A	N/A	N/A	Not required	VPP	Not required	N/A	Not enforced
Epic Haiku	Y	N/A	N/A	N/A	Not required	VPP	Not required	N/A	Not enforced
Epic Canto	Y	N/A	N/A	N/A	Not required	VPP	Not required	N/A	Not enforced
Epic Rover	Y	N/A	N/A	N/A	Not required	VPP	Not required	N/A	Not enforced
Epic Hyperspace	Y	N/A	N/A	N/A	Not required	N/A	Not required	N/A	Not enforced
Vocera	Y	Disallowed	Disallowed	Not required	Required	N/A	Required	Required	Enforced
HCMail	Y	Disallowed	Disallowed	Required	Required	N/A	Required	Required	Enforced
PatientRound- ing	Y	N/A	N/A	Required	Required	N/A	Not required	N/A	Not enforced
Outlook Web Access	Y	N/A	N/A	Not required	Required	N/A	Not required	N/A	Not enforced
SharePoint	Y	N/A	N/A	Not required	Required	N/A	Not required	N/A	Not enforced

User Communities

Jul 20, 2017

Every organization consists of diverse user communities that operate in different functional roles. These user communities perform different tasks and office functions using various resources that you provide through user mobile devices. Users might work from home or in remote offices using mobile devices that you provide. Or, users might use personal mobile devices, which allows them to access tools that are subject to certain security compliance rules.

With more user communities using mobile devices, Enterprise Mobility Management (EMM) becomes critical to prevent data leak and to enforce organizational security restrictions. In order for efficient and more sophisticated mobile device management, you can categorize your user communities. Doing so simplifies the mapping of users to resources and ensures that the right security policies apply to the right users.

Categorizing user communities can include use of the following components:

- Active Directory Organizational Units (OUs) and Groups

Users added to specific Active Directory security groups can receive policies and resources such as apps. Removing users from the Active Directory security groups removes access to previously allowed XenMobile resources.

- XenMobile local users and groups

For users who don't have an account in Active Directory, you can create the users as local XenMobile users. You can add local users to delivery groups and provision resources to them in the same manner as Active Directory users.

- XenMobile delivery groups

If multiple groups of users with different level of permissions are to consume a single app, you might need to create separate delivery groups. With separate delivery groups, you can deploy two separate versions of the same app.

- Delivery group and user group mapping

Delivery group to Active Directory group mappings can be either one-to-one, or one-to-many. Assign base policies and apps to a one-to-many delivery group mapping. Assign function-specific policies and apps to one-to-one delivery group mappings.

- Delivery Group and Resource Mapping of Apps

Assign specific apps to each delivery group.

- Delivery Group and Resource Mapping of MDM Resources

Assign apps and specific device management resources to each delivery group. For example, configure a delivery group with any mix of the following: Types of apps (public, HDX, and so on), specific apps per app type, and resources such as device policies and automated actions.

The following example illustrates how the user communities of a healthcare organization are classified for EMM.

Use Case

This example healthcare organization provides technology resources and access to multiple users, including network and affiliate employees and volunteers. The organization has chosen to roll out the EMM solution to non-executive users only.

You can divide user roles and functions for this organization into subgroups including: clinical, non-clinical, and contractors. A selected set of users receive corporate mobile devices, while others can access limited company resources from their personal devices (BYOD). To enforce the appropriate level of security restrictions and prevent data leak, the organization decided that corporate IT manages each enrolled device. Also, users can only enroll a single device.

The following section provides an overview of the roles and functions of each subgroup:

Clinical:

- Nurses
- Physicians (Doctors, Surgeons, and so on)
- Specialists (Dieticians, phlebotomists, anesthesiologists, radiologists, cardiologists, oncologists, and so on)
- Outside physicians (Non-employee physicians and office workers that work from remote offices)
- Home Health Services (Office and mobile workers performing physician services for patient home visits)
- Research Specialist (Knowledge Workers and Power Users at six Research Institutes performing clinical research to find answers to issues in medicine)
- Education and Training (Nurses, physicians, and specialists in education and training)

Non-Clinical:

- Shared Services (Office workers performing various back-office functions including: HR, Payroll, Accounts Payable, Supply Chain Service, and so on)
- Physician Services (Office workers performing various health care management, administrative services, and business process solutions to providers, including: Administrative Services, Analytics and Business Intelligence, Business Systems, Client Services, Finance, Managed Care Administration, Patient Access Solutions, Revenue Cycle Solutions, and so on)
- Support Services (Office workers performing various non-clinical functions including: Benefits Administration, Clinical Integration, Communications, Compensation & Performance Management, Facility & Property Services, HR Technology Systems, Information Services, Internal Audit & Process Improvement, and so on.)
- Philanthropic Programs (Office and mobile workers that perform various functions in support of philanthropic programs)

Contractors:

- Manufacturer and vendor partners (Onsite and remotely connected via site-to-site VPN providing various non-clinical support functions)

Based on the preceding information, the organization created the following entities. For more information about delivery groups in XenMobile, see [Deploy resources](#) in the XenMobile product documentation.

Active Directory Organizational Units (OUs) and Groups

OU	OU	Groups
XenMobile Resources	Clinical	XM-Nurses
		XM-Physicians
		XM-Specialists

		XM-Outside Physicians
		XM-Home Health Services
		XM-Research Specialist
		XM-Education and Training
	Non-Clinical	XM-Shared Services
		XM-Physician Services
		XM-Support Services
		XM-Philanthropic Programs

XenMobile Local Users and Groups

Group	Users
Contractors	Vendor1
	Vendor2
	Vendor3
	Vendor4
	Vendor5
	Vendor6
	Vendor7
	Vendor8
	Vendor9
	Vendor10

--	--

XenMobile Delivery Groups

Clinical-Nurses
Clinical-Physicians
Clinical-Specialists
Clinical-Outside Physicians
Clinical-Home Health Services
Clinical-Research Specialist
Clinical-Education and Training
Non-Clinical-Shared Services
Non-Clinical-Physician Services
Non-Clinical-Support Services
Non-Clinical-Philanthropic Programs

Delivery Group and User Group mapping

Active Directory Groups	XenMobile Delivery Groups
XM-Nurses	Clinical-Nurses
XM-Physicians	Clinical-Physicians
XM-Specialists	Clinical-Specialists
XM-Outside Physicians	Clinical-Outside Physicians
XM-Home Health Services	Clinical-Home Health Services

XM-Research Specialist	Clinical-Research Specialist
XM-Education and Training	Clinical-Education and Training
XM-Shared Services	Non-Clinical-Shared Services
XM-Physician Services	Non-Clinical-Physician Services
XM-Support Services	Non-Clinical-Support Services
XM-Philanthropic Programs	Non-Clinical-Philanthropic Programs

Delivery Group and Resource Mapping of Apps

	Secure Mail	Secure Web	Secure Notes	ShareFile	Receiver	SalesForce1	RSA SecurID	EpicCare Haiku	Epic Hyperspace
Clinical-Nurses	X	X	X	X					
Clinical-Physicians									
Clinical-Specialists									
Clinical-Outside Physicians	X		X	X					
Clinical-Home Health Services	X		X	X					
Clinical-Research Specialist	X		X	X					
Clinical-								X	X

Education and Training									
Non-Clinical-Shared Services								X	X
Non-Clinical-Physician Services								X	X
Non-Clinical-Support Services	X		X	X				X	X
Non-Clinical-Philanthropic Programs	X		X	X				X	X
Contractors	X		X	X	X	X		X	X

Delivery Group and Resource Mapping of MDM Resources

	MDM: Passcode policy	MDM: Device Restrictions	MDM: Automated Actions	MDM: WiFi policy
Clinical-Nurses				X
Clinical-Physicians		X		
Clinical-Specialists				
Clinical-Outside Physicians				
Clinical-Home Health Services				
Clinical-Research Specialist				
Clinical-Education and Training				

Non-Clinical-Shared Services				
Non-Clinical-Physician Services				
Non-Clinical-Support Services				
Non-Clinical-Philanthropic Programs				
Contractors				X

Notes and considerations:

- XenMobile creates a default delivery group named All Users during the initial configuration. If you do not disable this Delivery Group, all Active Directory users have rights to enroll into XenMobile.
- XenMobile synchronizes Active Directory users and groups on demand using a dynamic connection to the LDAP server.
- If a user is part of a group that is not mapped in XenMobile, that user cannot enroll. Likewise, if a user is a member of multiple groups, XenMobile only categorizes the user as being in the groups mapped to XenMobile.
- To make MDM enrollment mandatory, set the **Enrollment Required** option to **True** in **Server Properties** in the XenMobile console. For details, see [Server Properties](#).
- To delete a user group from a XenMobile delivery group, delete the entry in the SQL Server database, under `dbo.userlistgrps`.

Caution: Before you perform this action, create a backup of XenMobile and the database.

About Device Ownership in XenMobile

You can group users according to the owner of a user device. Device ownership includes corporate-owned devices and user-owned devices, also known as bring your own device (BYOD). You can control how BYOD devices connect to your network in two places in the XenMobile console: in Deployment Rules and through XenMobile server properties on the **Settings** page. For details about deployment rules, see [Deploy resources](#) in the XenMobile documentation. For details about server properties, see [Server Properties](#) in this handbook.

By setting server properties, you can require all BYOD users to accept corporate management of their devices before they can access apps. Or, you can give users access to corporate apps without also managing their devices.

When you set the server property **wsapi.mdm.required.flag** to **true**, XenMobile manages all BYOD devices, and any user who declines enrollment is denied access to apps. Consider setting **wsapi.mdm.required.flag** to **true** in environments in which enterprise IT teams need high security plus a positive user experience during enrolling.

If you leave **wsapi.mdm.required.flag** as **false**, which is the default setting, users can decline enrollment. However, they can access apps on their devices through the XenMobile Store. Consider setting **wsapi.mdm.required.flag** to **false** in environments in which privacy, legal, or regulatory constraints require no device management, only enterprise app management.

Users with devices that XenMobile doesn't manage can install apps through the XenMobile Store. Instead of device-level controls, such as selective or full wipe, you control access to the apps through app policies. Some policy settings require the device to check the XenMobile server routinely to confirm that the apps are still allowed to run.

Email Strategy

Jun 21, 2017

Secure access to email from mobile devices is one of the main drivers behind any organization's mobility management initiative. Deciding on the proper email strategy is often a key component of any XenMobile design. XenMobile offers several options to accommodate different use cases, based on security, user experience, and integration requirements. This article covers the typical design decision process and considerations for choosing the right solution, from client selection to mail traffic flow.

Choosing Your Email Clients

Client selection is generally at the top of the list when it comes to the overall email strategy design. You can choose from a number of clients, including Citrix Secure Mail, native mail that is included with a particular mobile platform operating system, or other third-party clients available through the public app stores. Depending on your needs, you can possibly support the user communities with a single (standard) client or you may need to use a combination of clients.

The following table outlines design considerations for the different client options available:

Topic	Secure Mail	Native (for example, iOS Mail)	Third-party (for example, TouchDown)
Minimum XenMobile Edition	Advanced	MDM	MDM
Configuration	Exchange account profiles configured via an MDX policy.	Exchange account profiles configured via an MDM policy. Note: Android support is limited to: SAFE/KNOX, HTC, and Android for Work. All other clients are considered third-party clients.	Generally requires manual configuration by the user. Configuration of Exchange account profiles via an MDM policy for TouchDown only.
Security	Secure by design. Security with MDX policies with added data encryption levels. Fully managed app via an MDX policy. Added layer of authentication with Citrix PIN. Highest security.	Based on vendor/app feature set. Makes use of device encryption settings (with no security via MDX policies). Relies on device-level authentication for access to the app. Higher security.	Based on vendor/app feature set. High security.

Integration	<p>Allows interaction with managed (MDX) apps by default.</p> <p>Open web URLs with Citrix Secure Web (intranet access).</p> <p>ShareFile integration (save to/attach from).</p> <p>GoToMeeting direct join/dial-in.</p>	Can only interact with other unmanaged (non-MDX) apps by default.	Can only interact with other unmanaged (non-MDX) apps by default.
Deployment/ Licensing	<p>You may push Secure Mail through MDM or make Secure Mail available as a self-service app from the XenMobile Store.</p> <p>Included with XenMobile Advanced and Enterprise licensing.</p>	<p>Client app included with platform operating system.</p> <p>No additional licensing requirements.</p>	<p>Can pushed via MDM, as an enterprise app or directly from public app stores.</p> <p>Associated licensing model/costs based on app vendor.</p>
Support	<p>Single vendor support for the client and EMM solution (Citrix).</p> <p>Embedded support contact info in Secure Hub/app debug logging capabilities.</p> <p>One client to support.</p>	<p>Vendor defined support (Apple/Google).</p> <p>May need to support different clients based on device platform.</p>	<p>Vendor-defined support</p> <p>One client to support, assuming that the third-party client is supported on all managed device platforms.</p>

Mail traffic flow and filtering considerations

This section discusses the three main scenarios and design considerations with regard to the flow of mail (ActiveSync) traffic in the context of XenMobile.

Scenario 1: Exposed Exchange

It is common for environments that support external clients to have Exchange ActiveSync services exposed to the Internet. Mobile ActiveSync clients connect through this externally facing path through a reverse proxy (for example, NetScaler) or through an edge server. This option is required for the use of native or third-party mail clients, making these clients the popular choice when it comes to this scenario. Although not a common practice, you could also use the Secure Mail client in this scenario. By doing so, you benefit from the security features offered by the use of MDX policies and management of the app.

Scenario 2: Tunneled via NetScaler (micro VPN and STA)

This is the default scenario when using the Secure Mail client given its micro VPN capabilities. In this case, the Secure Mail client establishes a secure connection to ActiveSync via NetScaler Gateway. In essence, you can consider Secure Mail to be

the client connecting directly to ActiveSync from the internal network. In many cases, Citrix customers are standardizing on Secure Mail as the mobile ActiveSync client of choice, as part of an initiative to eliminate the need to expose ActiveSync services to the Internet, as described in the first scenario, on an exposed Exchange Server.

Only managed (MDX wrapped) apps can use the micro VPN function. Therefore, this scenario does not apply to native clients. Even though it may be possible to wrap third-party clients with the MDX Toolkit, this practice is not common. The use of device-level VPN clients to allow tunneled access for native or third-party clients has proven to be cumbersome and not a viable solution.

Scenario 3: Cloud-hosted Exchange services

Cloud-hosted Exchange services, such as Microsoft Office 365, are becoming more popular. In the context of XenMobile, this scenario may be treated in the same way as the first scenario, because the ActiveSync service is exposed to the Internet as well. In this case, the client choices are dictated by the cloud service provider requirements, but the choices generally include support for most ActiveSync clients like Secure Mail and other native or third-party clients.

XenMobile can add value in three areas when it comes to this scenario:

- Client wrapping with MDX policies and app management with Secure Mail
- Client configuration with the use of an MDM policy on supported clients (native, such as TouchDown)
- ActiveSync filtering options with the use of XenMobile Mail Manager

Mail traffic filtering considerations

As with most services exposed to the Internet, you must secure the path and provide filtering for authorized access. The XenMobile solution includes two components designed specifically to provide ActiveSync filtering capabilities for native and third-party clients: XenMobile NetScaler Connector and XenMobile Mail Manager.

XenMobile NetScaler Connector

The use of XenMobile NetScaler Connector provides ActiveSync filtering at the perimeter, through the use of NetScaler as a proxy for ActiveSync traffic. This means that the filtering component sits in the path of mail traffic flow, intercepting mail as it enters or leaves the environment. XenMobile NetScaler Connector acts as an intermediary between NetScaler and the XenMobile server. When a device attempts communication to Exchange via the ActiveSync virtual server on the NetScaler, the NetScaler performs a HTTP callout to the XenMobile NetScaler Connector service, which then checks the device status with XenMobile. Based on the status of the device, XenMobile NetScaler Connector replies to NetScaler to either allow or deny the connection. You may also configure static rules to filter access based on user, agent, and device type or ID.

This setup allows Exchange ActiveSync services to be exposed to the Internet with an added layer of security to prevent unauthorized access. Design considerations include the following:

- Windows Server: The XenMobile NetScaler Connector component will require the deployment of a Windows Server.
- Filtering rule set: XenMobile NetScaler Connector is designed for filtering based on device state and information, rather than user information. Although you may configure static rules to filter by user ID, no options exist for filtering based on Active Directory group membership, for example. If there is a requirement for Active Directory group filtering, you may use XenMobile Mail Manager instead.
- NetScaler scalability: Given the requirement to proxy ActiveSync traffic via NetScaler, proper sizing of the NetScaler instance is critical to support the added workload of all ActiveSync SSL connections.
- NetScaler Integrated Caching: The XenMobile NetScaler Connector configuration on the NetScaler leverages the Integrated Caching function in order to cache responses from XenMobile NetScaler Connector. This eliminates the need

for the NetScaler to issue a request to XenMobile NetScaler Connector for every ActiveSync transaction in a given session; it is also critical for adequate performance and scale. Integrated Caching is available with the NetScaler Platinum Edition or may be licensed separately for Enterprise Editions.

- Custom filtering policies: You may need to create custom NetScaler policies to restrict certain ActiveSync clients outside of the standard native mobile clients. This configuration requires knowledge on ActiveSync HTTP requests and NetScaler responder policy creation.
- Secure Mail clients: Secure Mail has micro VPN capabilities which eliminate the need for filtering at the perimeter. The Secure Mail client would generally be treated as an internal (trusted) ActiveSync client when connected through the NetScaler Gateway. In the event that support for both native and third-party (with XenMobile NetScaler Connector) and Secure Mail clients is required, Citrix recommends that Secure Mail traffic does not flow via the NetScaler virtual server used for XenMobile NetScaler Connector. You can accomplish this traffic flow via DNS and keep the XenMobile NetScaler Connector policy from affecting Secure Mail clients.

For a diagram of XenMobile NetScaler Connector in a XenMobile deployment, see [Reference Architecture for On-Premises Deployments](#).

XenMobile Mail Manager

XenMobile Mail Manager is a XenMobile component that provides ActiveSync filtering at the Exchange service level. This means that filtering only occurs once the mail reaches the exchange service, rather than as soon as it enters the XenMobile environment. XenMobile Mail Manager uses PowerShell to query Exchange ActiveSync for device partnership information and control access through device quarantine actions, where devices are taken in and out of quarantine based on XenMobile Mail Manager rule criteria. Similar to XenMobile NetScaler Connector, XenMobile Mail Manager checks the device status with XenMobile in order to filter access based on device compliance. You may also configure static rules to filter access based on device type or ID, agent version, and Active Directory group membership.

This solution does not require the use of NetScaler. You can deploy XenMobile Mail Manager without making any changes in terms of routing for the existing ActiveSync traffic. Design considerations include:

- Windows Server: The XenMobile Mail Manager component requires you to deploy Windows Server.
- Filtering rule set: Just like XenMobile NetScaler Connector, XenMobile Mail Manager includes filtering rules to evaluate device state and. Additionally, XenMobile Mail Manager also supports static rules to filter based on Active Directory group membership.
- Exchange integration: XenMobile Mail Manager requires direct access to the Exchange Client Access Server (CAS) hosting the ActiveSync role and control over device quarantine actions. This may present a challenge depending on the environment's architecture and security posture, so it is critical that you evaluate this technical requirement up front.
- Other ActiveSync clients: Because XenMobile Mail Manager is filtering at the ActiveSync service level, you need to take into consideration other ActiveSync clients outside the XenMobile environment. You can configure XenMobile Mail Manager static rules to avoid unintended impact to other ActiveSync clients.
- Extended Exchange functions: Through direct integration with Exchange ActiveSync, XenMobile Mail Manager provides the ability for XenMobile to perform an Exchange ActiveSync wipe on a mobile device. XenMobile Mail Manager also allows XenMobile to access information about Blackberry devices, and to perform control operations, such as wipe and reset password.

For a diagram of XenMobile Mail Manager in a XenMobile deployment, see [Reference Architecture for On-Premises Deployments](#).

Email Platform Decision Tree

The following figure helps you distinguish the pros and cons between using native email or Secure Mail solutions in your XenMobile deployment. Each choice allows for associated XenMobile options and requirements to enable server, network, and database access. The pros and cons include details on security, policy, and user interface considerations.

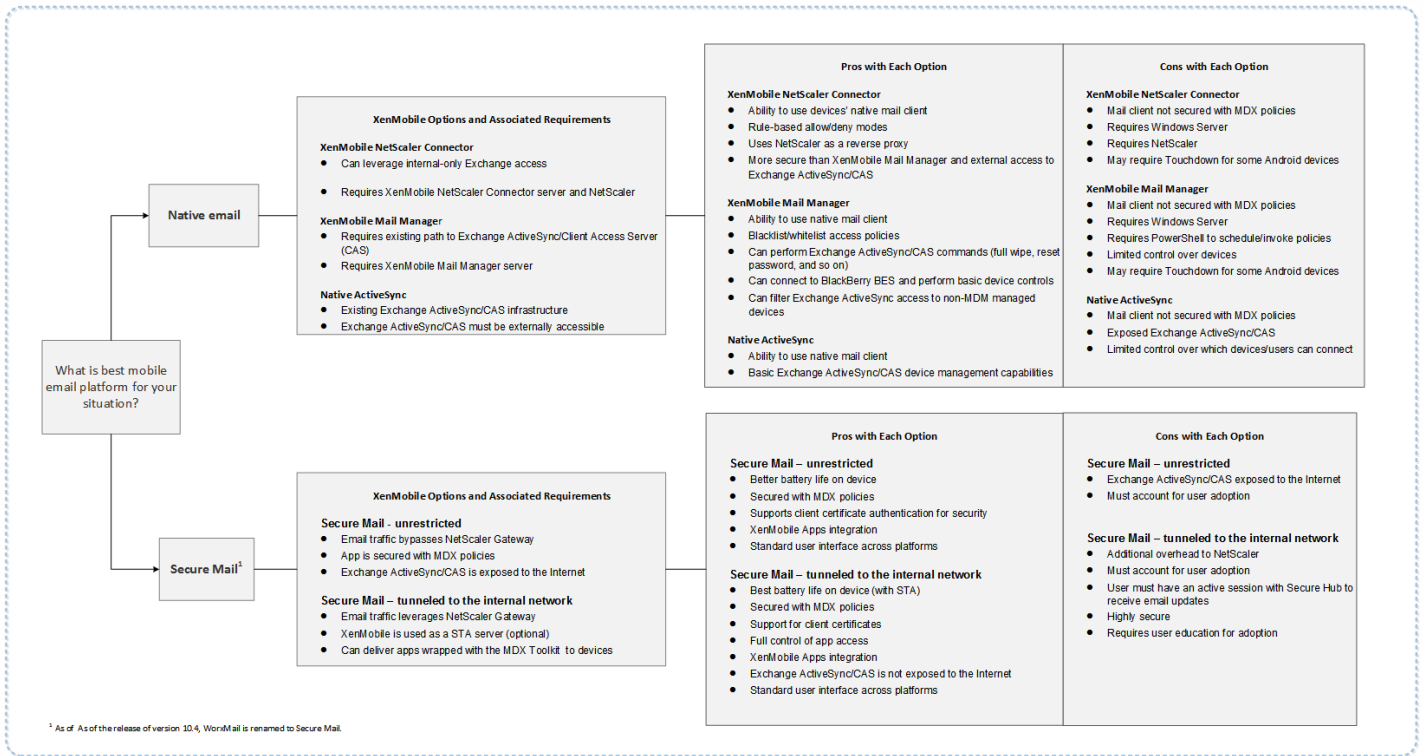

XenMobile Integration

Jun 21, 2017

This article covers what to consider when planning how XenMobile will integrate with your existing network and other solutions. For example, if you're already using NetScaler for XenApp and XenDesktop, should you use the existing NetScaler instance or a new, dedicated instance? Do you want to integrate with XenMobile the HDX apps that are published using StoreFront? Will you use ShareFile with XenMobile? Do you have a Network Access Control solution that you want to integrate into XenMobile? Do you deploy web proxies for all outbound traffic from your network?

NetScaler and NetScaler Gateway

NetScaler Gateway, which is mandatory for XenMobile ENT and MAM modes, provides a micro VPN path for access to all corporate resources and provides strong multi-factor authentication support. NetScaler load balancing is required for all XenMobile server device modes if you have multiple XenMobile servers or if the XenMobile server is inside your DMZ or internal network (and therefore traffic flows from devices to NetScaler to XenMobile).

You can leverage existing NetScaler instances or set up new ones for XenMobile. The following table notes the advantages and disadvantages of using existing or new, dedicated NetScaler instances.

Option	Advantages	Disadvantages
Shared NetScaler MPX with a NetScaler Gateway VIP created for XenMobile	<ul style="list-style-type: none">• Leverages a common NetScaler instance for all Citrix remote connections: XenApp, full VPN, and clientless VPN.• Leverages the existing NetScaler configurations, such as for certificate authentication and for accessing services like DNS, LDAP, and NTP.• Uses a single NetScaler platform license.	<ul style="list-style-type: none">• It is more difficult to plan for scale when you handle two very different use cases on the same NetScaler.• Sometimes you will need a specific NetScaler version for a XenApp use case. That same version might have known issues for XenMobile, or vice versa.• If a NetScaler Gateway already exists, you cannot run the NetScaler for XenMobile wizard a second time to create the NetScaler configuration for XenMobile.• Except when Platinum licenses are used for NetScaler Gateway 11.1 or later: User access licenses installed on NetScaler and required for VPN connectivity are pooled and so are available to all NetScaler virtual servers, which means that a non-XenMobile service can potentially consume them.
Dedicated NetScaler VPX/MPX instance	<p>Citrix recommends using a dedicated instance of NetScaler.</p> <ul style="list-style-type: none">• Easier to plan for scale and separates XenMobile traffic from a NetScaler instance that might already be resource constrained.• Avoids issues when XenMobile and XenApp need different	<ul style="list-style-type: none">• Requires setup of additional services on NetScaler to support XenMobile configuration.• Requires an additional NetScaler platform license. You must license each NetScaler instance for NetScaler Gateway.

NetScaler software versions. It is usually best to use the latest compatible NetScaler version and build for XenMobile.

- Allows XenMobile configuration of NetScaler through the built-in NetScaler for XenMobile wizard.
- Virtual and physical separation of services.
- Except when Platinum licenses are used for NetScaler Gateway 11.1 or later: The user access licenses required for XenMobile are only available to XenMobile services on the NetScaler.

For a table that summarizes the considerations for NetScaler and NetScaler Gateway integration for each XenMobile server mode, see [Integrating with NetScaler and NetScaler Gateway](#).

StoreFront

If you have a Citrix XenApp and XenDesktop environment, you can integrate HDX applications with XenMobile using StoreFront. When you integrate HDX apps with XenMobile:

- The apps are available to users who are enrolled with XenMobile.
- The apps display in the XenMobile Store along with other mobile apps.
- XenMobile uses the legacy PNAgent (services) site on StoreFront.
- HDX apps start using the Citrix Receiver mobile app if it's installed on the device.

StoreFront has a limitation of 1 services site per StoreFront instance. Citrix generally recommends that you consider a new StoreFront Instance and services site for XenMobile if you have multiple stores and want to segment it from other production usage.

Considerations include:

- Are there any different authentication requirements for StoreFront? The StoreFront services site requires Active Directory credentials for logon. Customers only using certificate-based authentication cannot enumerate applications through XenMobile using the same NetScaler Gateway.
- Use the same store or create a new one?
- Use the same or a different StoreFront server?

The following table notes the advantages and disadvantages of using separate or combined storefronts for Receiver and XenMobile Apps.

Option	Advantages	Disadvantages
---------------	-------------------	----------------------

Integrate your existing StoreFront instance with XenMobile server	<p>Same store: No additional configuration of StoreFront is required for XenMobile, assuming that you use the same NetScaler VIP for HDX access. If you choose to use the same store and want to direct Receiver access to a new NetScaler VIP, you must add the appropriate NetScaler Gateway configuration to StoreFront.</p> <p>Same StoreFront server: Leverage existing StoreFront installation and configuration.</p>	<p>Same store: Any reconfiguration of StoreFront to support XenApp and XenDesktop workloads may adversely affect XenMobile as well.</p> <p>Same StoreFront server: In large environments, consider the additional load from XenMobile usage of PNAgent for app enumeration and start-up.</p>
Leverage a new, dedicated StoreFront instance for integration with XenMobile server	<p>New store: Any configuration changes of the StoreFront store for XenMobile should not affect existing XenApp and XenDesktop workloads.</p> <p>New StoreFront server: Server configuration changes should not affect XenApp and XenDesktop workflow. Additionally, load outside of XenMobile usage of PNAgent for app enumeration and launch should not affect scalability.</p>	<p>New store: StoreFront store configuration.</p> <p>New StoreFront server: New StoreFront installation and configuration is required.</p>

For more information, see [XenApp and XenDesktop through Citrix Secure Hub](#) in the XenMobile documentation.

ShareFile

ShareFile enables users to access and sync all of their data from any device and securely share it with people both inside and outside the organization. If you integrate ShareFile with XenMobile Advanced Edition or Enterprise Edition, XenMobile can provide ShareFile with single sign-on authentication for XenMobile App users, Active Directory-based user account provisioning, and comprehensive access control policies. Mobile users can benefit from the full ShareFile Enterprise feature set.

Alternatively, you can configure XenMobile to integrate only with StorageZone Connectors. Through StorageZone Connectors, ShareFile provides access to documents and folders network file shares and in SharePoint sites, site collections, and document libraries. Connected file shares can include the same network home drives used in Citrix XenDesktop and XenApp environments. You use the XenMobile console to configure the integration with ShareFile Enterprise or StorageZones Connectors. For more information, see [ShareFile use with XenMobile](#).

The following table notes the questions to ask when making design decisions for ShareFile.

Option	Questions to Ask	Design Decision
Integrate with ShareFile Enterprise or only StorageZone Connectors	<ul style="list-style-type: none"> Do you need to store data in Citrix-managed StorageZones? Do you want to provide users with file sharing and sync capabilities? Do you want to enable users to access files on the ShareFile website? Or to access Office 365 content and Personal Cloud connectors from mobile devices? 	<p>If the answer to any of those questions is "yes," integrate with ShareFile Enterprise.</p> <p>An integration with only StorageZone Connectors gives iOS users secure mobile access to existing on-premises storage repositories, such as SharePoint sites and network file shares. In this configuration, you don't need to set up a ShareFile subdomain, provision users to ShareFile, or host ShareFile data. Using StorageZones Connectors with XenMobile complies with security restrictions against leaking user information outside of the corporate network.</p>
ShareFile StorageZones Controller server location	<ul style="list-style-type: none"> Will you require on-premises storage or features such as StorageZone Connectors? If using on-premises features of ShareFile, where will the ShareFile StorageZones Controllers sit in the network? 	<p>Determine whether to locate the StorageZones Controller server(s) in the ShareFile-managed cloud, in your on-premises single-tenant storage system, or in supported third-party cloud storage.</p> <p>StorageZones Controllers require some internet access to communicate with the Citrix ShareFile Control Plane. You can achieve this in a number of ways, including direct access, NAT/PAT configurations, or proxy configurations.</p>
StorageZone Connectors	<ul style="list-style-type: none"> What are the CIFS share paths? What are the SharePoint URLs? 	<p>Determine if on-premises StorageZones Controllers are required to access those locations.</p> <p>Due to StorageZone Connector communication with internal resources such as file repositories, CIFS shares, and SharePoint, Citrix recommends that StorageZones Controllers reside in the internal network behind DMZ firewall(s) and fronted by NetScaler.</p>
SAML integration with XenMobile Enterprise	<ul style="list-style-type: none"> Is Active Directory authentication required for ShareFile? Does first time use of the wrapped MDX ShareFile app require SSO? Is there a standard IdP in your current environment? How many domains are required to use SAML? Are there multiple email aliases for Active Directory users? Are there any Active Directory 	<p>XenMobile Enterprise environments may choose to leverage SAML as the authentication mechanism for ShareFile. The authentication options are:</p> <ul style="list-style-type: none"> Leverage XenMobile server as the Identity Provider (IdP) for SAML <p>This option can provide excellent user experience and automate ShareFile account creation, as well as enable mobile app SSO features.</p> <ul style="list-style-type: none"> XenMobile server is enhanced for this process: It does not require the synchronization of Active Directory. Use the ShareFile User Management Tool for user

domain migrations in progress or scheduled in the near future?

- provisioning.
- Leverage a supported third-party vendor as the IdP for SAML

If you have an existing and supported IdP and don't require mobile app SSO capabilities, this might be the best fit for you. Be aware that this option also requires the use of the ShareFile User Management Tool for account provisioning.

Leveraging third-party IdP solutions such as ADFS may also provide SSO capabilities on the Windows client side, so be sure to evaluate use cases before choosing your ShareFile SAML IdP.

Additionally, to satisfy both use cases, you can [Configure and ADFS and XenMobile as a Dual IdP](#).

Mobile Apps

- Which ShareFile mobile app will you use (public, MDM, MDX)?
- Is application wrapping required?

Beginning with the 10.4.1 release of XenMobile Apps, you can distribute XenMobile apps from the Apple App Store and Google Play Store. With that public app store distribution, you obtain wrapped apps from the Citrix downloads page and don't have to sign and wrap Citrix-developed apps with the MDX Toolkit.

If security is low and you don't require containerization, the public ShareFile application may not be suitable. In an MDM-only environment, you can leverage and deliver the MDM version of the ShareFile app using XenMobile in MDM mode.

For more information, see the "Apps" article in this handbook and [Citrix ShareFile for XenMobile](#) in the XenMobile Apps documentation.

Security, policies, and access control

- What restrictions do you require for desktop, web, and mobile users?
- What standard access control settings do you want for users?
- What file retention policy will you use?

ShareFile lets you manage employee permissions and device security. For information, see [Employee Permissions](#) and [Managing Devices and Apps](#).

Some ShareFile device security settings and MDX policies control the same features. In those cases, XenMobile policies take precedence, followed by the ShareFile device security settings. Examples: If you disable external apps in ShareFile, but enable them in XenMobile, the external apps will be disabled in ShareFile. If the XenMobile configuration doesn't require a PIN/passcode, but the ShareFile configuration requires one, XenMobile won't require a PIN/passcode, but the ShareFile app will.

Standard vs.
Restricted
StorageZones

Do you require Restricted
StorageZones?

A standard StorageZone is intended for non-sensitive data and enables employees to share data with non-employees. This option supports workflows that involve sharing data outside of your domain.

A restricted StorageZone protects sensitive data: Only authenticated domain users can access the data stored in the zone.

Web Proxies

The most likely scenario for routing XenMobile traffic through an HTTP(S)/SOCKS proxy is when the subnet that the XenMobile server resides in doesn't have outbound Internet access to the required Apple, Google, or Microsoft IP addresses. You can specify proxy server settings in XenMobile to route all Internet traffic to the proxy server. For more information, see [Enable proxy servers](#).

The following table describes the advantages and disadvantages of the most common proxy used with XenMobile.

Option	Advantages	Disadvantages
Use an HTTP(S)/SOCKS Proxy with XenMobile server.	In cases where policies do not permit outbound Internet connections from the XenMobile server subnet, you can configure an HTTP(S) or SOCKS proxy to provide Internet connectivity.	If the proxy server fails, APNs (iOS) or Google Cloud Messaging (Android) connectivity breaks, which causes device notifications to fail for all iOS and Android devices.
Use an HTTP(S) Proxy with Secure Web.	You can monitor HTTP/HTTPS traffic to ensure that Internet activity complies with your organization's standards.	This configuration requires all Secure Web Internet traffic to tunnel back to the corporate network before they are sent back out to the Internet. As a result, this could affect Internet browsing performance, if browsing is constrained by your organization's Internet connection.

Your NetScaler session profile configuration for split tunneling affects the traffic as follows.

When NetScaler Split Tunneling is **off**:

- All traffic is forced to use the micro VPN or clientless VPN (cVPN) tunnel back to the NetScaler Gateway, if the MDX **Network access** policy is **Tunneled to the internal network**.
- You must configure NetScaler traffic policies/profiles for the proxy server and bind them to the NetScaler Gateway VIP.

Important: Be sure to exclude Secure Hub cVPN traffic from the proxy.

- For more information, see [XenMobile WorxWeb Traffic Through Proxy Server in Secure Browse Mode](#).

When **NetScaler Split Tunneling** is **on**:

- Apps configured with the MDX **Network access** policy set to **Tunneled to the internal network** first attempt to get the web resource directly and then fall back to NetScaler Gateway if the web resource is not publicly available.
- You must configure NetScaler traffic policies/profiles for the proxy server and bind them to the NetScaler Gateway VIP.

Important: Be sure to exclude Secure Hub cVPN traffic from the proxy.

Your NetScaler session profile configuration for **Split DNS** (under **Client experience**) functions similarly to Split Tunneling.

With **Split DNS** enabled and set to **Both**:

- The client first attempts to resolve the FQDN locally and then falls back to NetScaler for DNS resolution in the event of failure.

With **Split DNS** set to **Remote**:

- DNS resolution occurs only on NetScaler.

With **Split DNS** set to **Local**:

- The client attempts to resolve the FQDN locally. NetScaler isn't used for DNS resolution.

Access Control

Enterprises can now manage mobile devices inside and outside of networks. Enterprise Mobility Management solutions such as XenMobile are great at providing security and controls for mobile devices independent of location. However, when coupled with a Network Access Control (NAC) solution, you can add quality of service and more fine-grained control to devices that are internal to your network. That combination enables you to extend the XenMobile-managed device security assessment through your NAC solution, which can then use the XenMobile security assessment to facilitate and handle authentication decisions. Citrix has validated NAC integration with XenMobile for Cisco Identity Services Engine (ISE) or ForeScout; Citrix doesn't guarantee integration for other NAC solutions.

Advantages of a NAC solution integration with XenMobile include the following:

- Better security, compliance and control for all endpoints on an enterprise network.
- A NAC solution can detect devices at the instant they attempt to connect to your network, query XenMobile for device attributes, and then use that information to determine whether to allow, block, limit, or redirect those devices depending on the security policies you choose to enforce.
- A NAC solution provides IT administrators with a view of unmanaged and non-compliant devices.

For a description of the NAC compliance filters supported by XenMobile, see [Network Access Control](#) in the XenMobile documentation.

Multi-Site Requirements

Jun 21, 2017

You can architect and configure XenMobile deployments that include multiple sites for high availability and disaster recovery. This article provides an overview of the high availability and disaster recovered models used in XenMobile deployments.

High Availability

- For XenMobile cluster nodes, NetScaler handles the load balancing.
- XenMobile server nodes operate in an active/active configuration.
- Additional XenMobile server nodes are added to a high availability cluster as capacity is required. One node can handle up to approximately 8,500 user devices (see [Scalability and performance](#) for additional detail).
- Citrix recommends configuring "n+1" XenMobile servers: one server for every 8,500 user devices and one extra server for redundancy.
- Citrix recommends high availability for all NetScaler instances wherever possible to allow the configurations to sync with a second NetScaler.
- The standard NetScaler high availability pair operates in an active/passive configuration.

A typical high availability XenMobile deployment typically includes:

- Two NetScaler instances (VPX or MPX). If the NetScaler SDX platform is used, high availability should also be considered.
- Two or more XenMobile servers configured with the same database settings.

Disaster Recovery

You can configure XenMobile for disaster recovery across two data centers with one active data center and one passive data center. NetScaler and Global Server Load Balancing (GSLB) are used to create an active/active data path so that the user experience is that of an active/active setup.

For disaster recovery, a XenMobile deployment includes:

- Two data centers; each contains one or more NetScaler instances, XenMobile servers, and SQL Server databases.
- A GSLB server to direct traffic to the data centers. The GSLB server is configured for both the XenMobile enrollment URL and NetScaler Gateway URL handling traffic to the site.
- When you use the NetScaler for XenMobile wizard to configure NetScaler Gateway, by default, the GSLB is not enabled to resolve traffic to the XenMobile enrollment server and traffic to the NetScaler Gateway, en route to the MAM load-balancing server; as a result, additional steps are required. For more information on preparing for and implementing these steps, see [Disaster Recovery](#).
- Clustered SQL Servers of Always On Availability Groups.
- Latency between the XenMobile servers and SQL Server must be less than 5 ms.

Note

The disaster recovery methods described in this handbook provide only automated disaster recovery for the access layer. You must manually start all XenMobile server nodes and the SQL Server database at the failover site before devices can connect the XenMobile server.

Integrating with NetScaler Gateway and NetScaler

Jun 21, 2017

When integrated with XenMobile, NetScaler Gateway provides an authentication mechanism for remote device access to the internal network for MAM devices. The integration enables XenMobile Apps to connect to corporate servers in the intranet through a micro VPN created from the apps on the mobile device to NetScaler Gateway.

NetScaler load balancing is required for all XenMobile server device modes if you have multiple XenMobile servers or if the XenMobile server is inside your DMZ or internal network (and therefore traffic flows from devices to NetScaler to XenMobile).

The following table summarizes NetScaler Gateway and NetScaler integration with XenMobile.

XenMobile Server mode	NetScaler Gateway/NetScaler integration	Notes
MAM	NetScaler Gateway: Required NetScaler: Recommended for load balancing	For MAM-only mode, you must use NetScaler Gateway, which provides a micro VPN path for access to all corporate resources and provides strong multi-factor authentication support. Citrix recommends that you deploy XenMobile in a high availability configuration, which requires a load balancer in front of XenMobile. For details, see About MAM and Legacy MAM Modes .
MDM	NetScaler Gateway: Not required NetScaler: Recommended for security and load balancing	For MDM deployments, Citrix recommends NetScaler Gateway for mobile device VPN. Citrix recommends that you deploy a NetScaler appliance in front of XenMobile server, for security and load balancing. For standard deployments with XenMobile server in the DMZ, Citrix recommends the NetScaler for XenMobile wizard along with XenMobile server load balancing in SSL Bridge mode. You can also consider SSL Offload for deployments where XenMobile server resides in the internal network rather than the DMZ and/or where security requires such configurations. While you might consider exposing XenMobile server to the Internet via NAT or existing third-party proxies or load-balancers for MDM provided that the SSL traffic terminates on XenMobile server (SSL Bridge), Citrix does not recommend that approach due to the potential security risk. For high security environments, NetScaler with the default XenMobile configuration should meet or exceed security requirements. For MDM environments with the highest security needs, SSL termination at the NetScaler provides the ability to inspect traffic at the perimeter, while maintaining end-to-end SSL encryption. For more information, see Security Requirements . NetScaler offers:

- Options to define SSL/TLS ciphers
- SSL FIPS NetScaler hardware

ENT	NetScaler Gateway: Required NetScaler: Recommended for load balancing	<p>When the XenMobile server mode is ENT and a user opts out of MDM enrollment, the device operates in the legacy MAM mode. In the legacy MAM mode, devices enroll using the NetScaler Gateway FQDN. For details, see About MAM and Legacy MAM Modes.</p> <p>Citrix recommends that you deploy a NetScaler appliance in front of XenMobile server, for security and load balancing. For standard deployments with XenMobile server in the DMZ, Citrix recommends the NetScaler for XenMobile wizard along with XenMobile server load balancing in SSL Bridge mode. You can also consider SSL Offload for deployments where XenMobile server resides in the internal network rather than the DMZ and/or where security requires such configurations.</p> <p>Although you might consider exposing XenMobile server to the Internet via NAT or existing third-party proxies or load-balancers for MDM provided that the SSL traffic terminates on XenMobile server (SSL Bridge), Citrix does not recommend that approach due to the potential security risk.</p> <p>For high security environments, NetScaler with the default XenMobile configuration should meet or exceed security requirements.</p> <p>For MDM environments with the highest security needs, SSL termination at the NetScaler provides the ability to inspect traffic at the perimeter, while maintaining end-to-end SSL encryption. For more information, see Security Requirements. NetScaler offers:</p> <ul style="list-style-type: none"> • Options to define SSL/TLS ciphers • SSL FIPS NetScaler hardware
-----	---	---

Important

Be aware that for initial enrollment, the traffic from user devices authenticates on the XenMobile server whether you configure load balancing virtual servers to SSL Offload or SSL Bridge.

Design Decisions

The following table summarizes the many design decisions to consider when planning a NetScaler Gateway integration with XenMobile.

Design decision	Decision detail	Design guidance
Licensing	What edition	Ensure that you apply the proper licenses to the NetScaler Gateway. If you are using

and edition	of NetScaler will you use?	XenMobile NetScaler Connector, integrated caching might be required; therefore, you must ensure that the appropriate NetScaler Edition is in place.
	Have you applied Platform licenses to NetScaler?	The license requirements to enable NetScaler features are as follows. <ul style="list-style-type: none"> • XenMobile MDM load balancing requires a NetScaler standard platform license at a minimum. • ShareFile load balancing with StorageZones Controller requires a NetScaler standard platform license at a minimum.
	If you require MAM functionality, have you applied the NetScaler Universal Access Licenses?	<ul style="list-style-type: none"> • The XenMobile Enterprise edition includes the required NetScaler Gateway Universal licenses for MAM. • Exchange load balancing requires a NetScaler Platinum platform license or a NetScaler Enterprise platform license with the addition of an Integrated Caching license.
NetScaler version for XenMobile	What version is the NetScaler running in the XenMobile environment?	Citrix recommends using a dedicated instance of NetScaler for your NetScaler Gateway virtual server. Be sure that the minimum required NetScaler version and build is in use for the XenMobile environment. It is usually best to use the latest compatible NetScaler version and build for XenMobile. If upgrading NetScaler Gateway would affect your existing environments, a second dedicated instance for XenMobile might be appropriate.
	Will a separate instance be required?	If you plan to share a NetScaler instance for XenMobile and other apps that use VPN connections, be sure that you have enough VPN licenses for both. Keep in mind that XenMobile test and production environments cannot share a NetScaler instance.
Certificates	Do you require a higher degree of security for enrollments and access to the XenMobile environment?	The default configuration for XenMobile is user name and password authentication. To add another layer of security for enrollment and access to XenMobile environment, consider using certificate-based authentication. You can use certificates with LDAP for two-factor authentication, providing a higher degree of security without needing an RSA server.
	Is LDAP not an option?	If you don't allow LDAP and use smart cards or similar methods, configuring certificates allows you to represent a smart card to XenMobile. Users then enroll using a unique PIN that XenMobile generates for them. After a user has access, XenMobile creates and deploys the certificate subsequently used to authenticate to the XenMobile environment.
		XenMobile supports Certificate Revocation List (CRL) only for a third party Certificate Authority. If you have a Microsoft CA configured, XenMobile uses NetScaler to manage revocation. When you configure client certificate-based authentication, consider whether you need to configure the NetScaler Certificate Revocation List (CRL) setting, Enable CRL Auto Refresh . This step ensures that the user of a device in MAM-only

mode can't authenticate using an existing certificate on the device; XenMobile re-issues a new certificate, because it doesn't restrict a user from generating a user certificate if one is revoked. This setting increases the security of PKI entities when the CRL checks for expired PKI entities.

Networking topology What NetScaler topology is required? Citrix recommends using a NetScaler instance for XenMobile. However, if you don't want traffic going from the inside network out to the DMZ, you might consider setting up an additional instance of NetScaler, so that you're using one NetScaler instance for internal users and one for external users. Be aware that when users switch between the internal and external networks, DNS record caching can result in an increase in logon prompts in Secure Hub.

Note that XenMobile does not currently support NetScaler Gateway double hop.

Dedicated or shared NetScaler Gateway VIPs Do you currently use NetScaler Gateway for XenApp and XenDesktop? When your Citrix environment includes XenMobile, plus XenApp and XenDesktop, you can use the same NetScaler instance and NetScaler Gateway virtual server for both. Due to potential versioning conflicts and environment isolation, a dedicated NetScaler instance and NetScaler Gateway are recommend for each XenMobile environment. However, if a dedicated NetScaler instance is not an option, Citrix recommends using a dedicated NetScaler Gateway vServer rather than a vServer shared between XenMobile and XenApp and XenDesktop, to separate the traffic flows for Secure Hub.

Will XenMobile leverage the same NetScaler Gateway as XenApp and XenDesktop? If you use LDAP authentication, Receiver and Secure Hub can authenticate to the same NetScaler Gateway with no issues. If you use certificate-based authentication, XenMobile pushes a certificate in the MDX container and Secure Hub uses the certificate to authenticate with NetScaler Gateway. Receiver is separate from Secure Hub and can't use the same certificate as Secure Hub to authenticate to the same NetScaler Gateway.

What are the authentication requirements for both traffic flows? You might consider this work around, which allows you to use the same FQDN for two NetScaler Gateway VIPs. You can create two NetScaler Gateway VIPs with the same IP address, but the one for Secure Hub uses the standard 443 port and the one for XenApp and XenDesktop (which deploy Receiver) uses port 444. Then, one FQDN resolves to the same IP address. For this work around, you might need to configure StoreFront to return an ICA file for port 444, instead of the default, port 443. This workaround doesn't require users to enter a port number.

NetScaler Gateway time-outs How do you want to configure the NetScaler Gateway time-outs for XenMobile traffic? NetScaler Gateway includes the settings Session time-out and Forced time-out. For details, see [Recommended Configurations](#) in this handbook. Keep in mind that there are different time-out values for background services, NetScaler, and for accessing applications while offline.

XenMobile load balancer IP address for MAM	Are you using internal or external IP addresses for VIPs?	<p>In environments where you can use public IP addresses for NetScaler Gateway VIPs, assigning the XenMobile load balancing VIP and address in this manner will cause enrollment failures.</p> <p>Ensure that the load balancing VIP uses an internal IP to avoid enrollment failures in this scenario. This virtual IP address must follow the RFC 1918 standard of private IP addresses. If you use a non-private IP address for this virtual server, NetScaler will not be able to contact the XenMobile server successfully during the authentication process. For details, see http://support.citrix.com/article/CTX200430.</p>
MDM load balancing mechanism	How will the XenMobile servers be load balanced by NetScaler Gateway?	<p>Use SSL Bridge if XenMobile is in the DMZ. Use SSL Offload, if required to meet security standards, when XenMobile server is in the internal network.</p> <ul style="list-style-type: none"> • When you load balance XenMobile server with NetScaler VIPs in SSL Bridge mode, Internet traffic flows directly to XenMobile server, where connections terminate. SSL Bridge mode is the simplest mode to set up and troubleshoot. • When you load balance XenMobile server with NetScaler VIPs in SSL Offload mode, Internet traffic flows directly to NetScaler, where connections terminate. NetScaler then establishes new sessions from NetScaler to XenMobile server. SSL Offload mode involves additional complexity during setup and troubleshooting.
Service port for MDM load balancing with SSL Offload	If you will use SSL Offload mode for Load Balancing, What port will the back-end service use?	<p>For SSL Offload, choose port 80 or 8443 as follows:</p> <ul style="list-style-type: none"> • Leverage port 80 back to XenMobile server, for true offloading. • End-to-end encryption, that is, re-encryption of traffic, isn't supported. For details, see the Citrix support article, Supported Architectures Between NetScaler and XenMobile Server.
Enrollment FQDN	What will be the FQDN for enrollment and XenMobile instance/load balancing VIP?	<p>Initial configuration of the first XenMobile server in a cluster requires that you enter the XenMobile server FQDN. That FQDN must match your MDM VIP URL and your Internal MAM LB VIP URL. (An internal NetScaler address record resolves the MAM LB VIP.) For details, see Enrollment FQDN for each deployment type after this table.</p> <p>In addition, you must use the same certificate as the XenMobile SSL listener certificate, Internal MAM LB VIP certificate, and MDM VIP certificate (if using SSL Offload for MDM VIP).</p> <p>Important: After you configure the enrollment FQDN, you cannot change it. A new enrollment FQDN will require a new SQL Server database and XenMobile server re-build.</p>
Secure Web traffic	Will you restrict	If you will use Secure Web for internal web browsing only, NetScaler Gateway configuration is straightforward, assuming that Secure Web can reach all internal sites

	<p>Secure Web to internal web browsing only?</p> <p>Will you enable Secure Web for both internal and external web browsing?</p>	<p>by default; you might need to configure firewalls and proxy servers.</p> <p>If you will use Secure Web for both internal and external browsing, you must enable the SNIP to have outbound internet access. Because IT generally views enrolled devices (using the MDX container) as an extension of the corporate network, IT typically wants Secure Web connections to come back to NetScaler, go through a proxy server, and then go out to Internet. By default, Secure Web access tunnels to the internal network, which means that Secure Web uses a per-application VPN tunnel back to the internal network for all network access and NetScaler uses split tunnel settings.</p> <p>For a discussion of Secure Web connections, see Configuring User Connections in the XenMobile Apps documentation.</p>
<p>Push Notifications for Secure Mail</p>	<p>Will you use push notifications?</p>	<p>For iOS:</p> <p>If your NetScaler Gateway configuration includes Secure Ticket Authority (STA) and split tunneling is off, NetScaler Gateway must allow traffic from Secure Mail to the Citrix listener service URLs specified in Push Notifications for Secure Mail for iOS.</p> <p>For Android:</p> <p>As an alternative to the MDX policy, Active poll period, you can use Google Cloud Messaging (GCM) to control how and when Android devices need to connect to XenMobile. With GCM configured, any security action or deploy command triggers a push notification to Secure Hub to prompt the user to reconnect to the XenMobile server.</p>
<p>HDX STAs</p>	<p>What STAs to use if you will integrate HDX application access?</p>	<p>HDX STAs must match the STAs in StoreFront and must be valid for the XenApp/XenDesktop farm.</p>
<p>ShareFile</p>	<p>Will you use ShareFile StorageZone Controllers in the environment?</p> <p>What ShareFile VIP URL will you use?</p>	<p>If you will include ShareFile StorageZone Controllers in your environment, ensure that you correctly configure the following: ShareFile Content Switch VIP (used by the ShareFile Control Plane to communicate with the StorageZone Controller servers), ShareFile Load Balancing VIPs, and all required policies and profiles. For information, see Configure NetScaler for StorageZones Controller in the Citrix StorageZones documentation.</p>
<p>SAML IDP</p>	<p>If SAML is</p>	<p>The recommended best practice is to integrate ShareFile with XenMobile Advanced</p>

required for ShareFile, do you want to use XenMobile as the SAML IdP?

Edition or XenMobile Enterprise Edition, a simpler alternative to configuring SAML-based federation. When you use ShareFile with those XenMobile editions, XenMobile provides ShareFile with single sign-on (SSO) authentication of XenMobile Apps users, user account provisioning based on Active Directory, and comprehensive access control policies. The XenMobile console enables you to perform ShareFile configuration and to monitor service levels and license usage.

Note that there are two types of ShareFile clients: ShareFile Worx clients (also referred to as wrapped ShareFile) and ShareFile mobile clients (also referred to as unwrapped ShareFile). To understand the differences, see [How ShareFile Worx Clients Differ from ShareFile Mobile Clients](#) in the XenMobile documentation.

You can configure XenMobile and ShareFile to use SAML to provide SSO access to ShareFile mobile apps you wrap with the MDX toolkit, as well as to non-wrapped ShareFile clients, such as the web site, Outlook plugin, or sync clients.

If you want to use XenMobile as the SAML IdP for ShareFile, ensure that the proper configurations are in place. For details, see [SAML for SSO with ShareFile](#) in the XenMobile documentation.

ShareConnect direct connections

Will users access a host computer from a computer or mobile device running ShareConnect using direct connections?

ShareConnect enables users to connect securely to their computers through iPads, Android tablets, and Android phones to access their files and applications. For direct connections, XenMobile uses NetScaler Gateway to provide secure access to resources outside of the local network. For configuration details, see [ShareConnect](#) in the XenMobile documentation.

Enrollment FQDN for each deployment type

Deployment type	Enrollment FQDN
Enterprise (MDM+MAM) with mandatory MDM enrollment	XenMobile server FQDN
Enterprise (MDM+MAM) with optional MDM enrollment	XenMobile server FQDN or NetScaler Gateway FQDN
MDM only	XenMobile server FQDN
MAM-only (legacy)	NetScaler Gateway FQDN
MAM-only (for XenMobile 10.3.5 and higher)	XenMobile server FQDN

Deployment Summary

The XenMobile product documentation includes a [Flowchart for Deploying XenMobile with NetScaler Gateway](#) along with links to related articles, such as system requirements, gathering required information, configuring XenMobile for NetScaler Gateway, and using the NetScaler for XenMobile wizard to configure XenMobile connections.

Citrix recommends that you use the NetScaler for XenMobile wizard to ensure proper configuration. Be aware that you can use the wizard only one time. If you have multiple XenMobile instances, such as for test, development, and production environments, you must configure NetScaler for the additional environments manually. When you have a working environment, take note of the settings before attempting to configure NetScaler manually for XenMobile.

The key decision you make when using the wizard is whether to use HTTPS or HTTP for communication to the XenMobile server. HTTPS provides secure back-end communication, as traffic between NetScaler and XenMobile is encrypted; the re-encryption impacts XenMobile server performance. HTTP provides better XenMobile server performance; traffic between NetScaler and XenMobile is not encrypted. The following tables show the HTTP and HTTPS port requirements for NetScaler and XenMobile server.

HTTPS

Citrix typically recommends SSL Bridge for NetScaler MDM virtual server configurations. For NetScaler SSL Offload use with MDM virtual servers, XenMobile supports only port 80 as the backend service.

Deployment type	NetScaler load balancing method	SSL re-encryption	XenMobile server port
MDM	SSL Bridge	N/A	443, 8443
MAM	SSL Offload	Enabled	8443
Enterprise	MDM: SSL Bridge	N/A	443, 8443
	MAM: SSL Offload	Enabled	8443

HTTP

Deployment type	NetScaler load balancing method	SSL re-encryption	XenMobile server port
MDM	SSL Offload	Not supported	80
MAM	SSL Offload	Enabled	8443
Enterprise	MDM: SSL Offload	Not supported	80
	MAM: SSL Offload	Enabled	8443

For diagrams of NetScaler Gateway in XenMobile deployments, see [Reference Architecture for On-Premises Deployments](#) and [Reference Architecture for Cloud Deployments](#).

SSO and Proxy Considerations for MDX Apps

Jun 21, 2017

XenMobile integration with NetScaler enables you to provide users with single sign-on (SSO) to all backend HTTP/HTTPS resources. Depending on your SSO authentication requirements, you can configure user connections for an MDX app to use Secure Browse, which is a type of clientless VPN, or Full VPN Tunnel. If NetScaler isn't the best way to provide SSO in your environment, you can set up an MDX app with policy-based local password caching. This article explores the various SSO and proxy options, with a focus on Secure Web. The concepts apply to other MDX apps.

The following flow chart summarizes the decision flow for SSO and user connections.

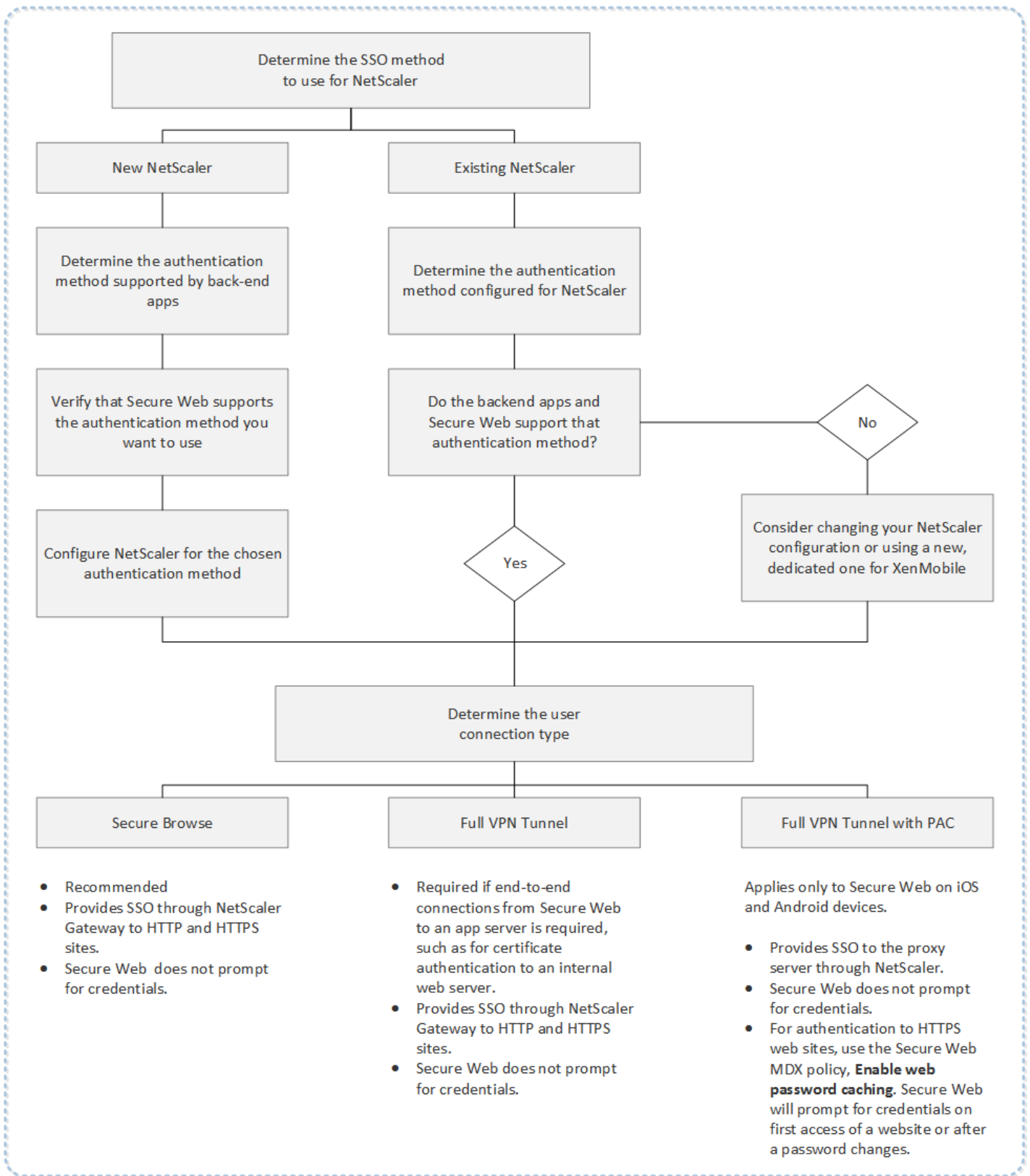

NetScaler Authentication Methods

This table provides some general information about the authentication methods supported by NetScaler.

Authentication option	Configuration requirement summary
<p>SAML Authentication</p> <p>When you configure NetScaler for Security Assertion Markup Language (SAML), users can connect to web applications that support the SAML protocol for single sign-on. NetScaler Gateway supports the identity provider (IdP) single sign-on for SAML web applications.</p>	<p>Configure SAML SSO in the NetScaler Traffic profile. Configure the SAML IdP for the requested service.</p>
<p>NTLM Authentication</p> <p>NetScaler performs this automatically if SSO to web applications is enabled in the session profile.</p>	<p>Enable SSO in the NetScaler Session or Traffic profile.</p>
<p>Kerberos Impersonation</p> <p>XenMobile supports Kerberos for Secure Web only.</p> <p>When you configure NetScaler for Kerberos SSO, NetScaler uses impersonation when a user's password is available to NetScaler. Impersonation means that NetScaler leverages user credentials to get the ticket needed to gain access to service(s), such as Secure Web.</p>	<p>Configure the NetScaler Worx Session policy to allow it to identify the Kerberos Realm from your connection.</p> <p>Configure on NetScaler a Kerberos Constrained Delegation (KCD) account that has no password and is bound to a traffic policy on your XenMobile gateway.</p> <p>For those and other configuration details, see the Citrix blog, WorxWeb and Kerberos Impersonation SSO.</p>
<p>Kerberos Constrained Delegation</p> <p>XenMobile supports Kerberos for Secure Web only.</p> <p>When you configure NetScaler for Kerberos SSO, NetScaler uses constrained delegation when a user's password is not available to NetScaler. With constrained delegation, NetScaler uses a specified administrator account to get tickets on behalf of users and services.</p>	<p>Configure a KCD account in Active Directory with the required permissions and a KDC account on NetScaler.</p> <p>Enable SSO in the NetScaler Traffic profile.</p> <p>Configure the back-end Website for Kerberos authentication.</p> <p>For those and other configuration details, see the Citrix blog, Configuring Kerberos Single Sign-on for WorxWeb.</p>
<p>Form Fill Authentication</p> <p>When you configure NetScaler for Form-based single sign-on, users can log on one time to access all protected applications in your network.</p>	<p>Configure Form-based SSO in the NetScaler Traffic profile.</p>

Applies to apps that use Secure Browse or Full VPN modes.	
<p>Digest HTTP Authentication</p> <p>NetScaler performs this automatically if you enable SSO to web applications in the session profile.</p> <p>Applies to apps that use Secure Browse or Full VPN modes.</p>	Enable SSO in the NetScaler Session or Traffic profile.
<p>Basic HTTP Authentication</p> <p>NetScaler performs this automatically if you enable SSO to web applications in the session profile.</p> <p>Applies to apps that use Secure Browse or Full VPN modes.</p>	Enable SSO in the NetScaler Session or Traffic profile.

Secure Browse, Full VPN Tunnel, or Full VPN Tunnel with PAC

In addition to the following table that describes the user connection types for Secure Web, also see this Secure Web article in the Citrix documentation, [Configuring User Connections](#).

User connection type	Description
Full VPN Tunnel	<p>Connections that tunnel to the internal network can use a full VPN tunnel, configured by the Secure Web Preferred VPN mode policy. Citrix recommends Full VPN tunnel for connections that use client certificates or end-to-end SSL to a resource in the internal network. Full VPN tunnel handles any protocol over TCP. You can use full VPN tunnel with Windows and Mac computers as well as iOS and Android devices.</p> <p>In Full VPN Tunnel mode, NetScaler does not have visibility inside an HTTPS session.</p>
Secure Browse	<p>Connections that tunnel to the internal network can use a variation of a clientless VPN, referred to as Secure Browse. This is the default configuration specified for the Secure Web Preferred VPN mode policy. Citrix recommends Secure Browse for connections that require single sign-on (SSO).</p> <p>In Secure Browse mode, NetScaler breaks the HTTPS session into two parts: Client-to-NetScaler and NetScaler-to-back-end resource server. In this manner, NetScaler has full visibility into all transactions between the client and server, enabling it to provide SSO.</p> <p>You can also configure proxy servers for Secure Web when used in secure browse mode. For details, see the blog XenMobile WorxWeb Traffic Through Proxy Server in Secure Browse Mode.</p>
Full VPN Tunnel with PAC	You can use a Proxy Automatic Configuration (PAC) file with a full VPN tunnel deployment for Secure Web on iOS and Android devices. XenMobile supports proxy

authentication if provided by NetScaler. A PAC file contains rules that define how web browsers select a proxy to access a given URL. PAC file rules can specify handling for both internal and external sites. Secure Web parses PAC file rules and send the proxy server information to NetScaler Gateway. NetScaler Gateway is unaware of the PAC file or proxy server.

For authentication to HTTPS web sites, the Secure Web MDX policy, **Enable web password caching**, enables Secure Web to authenticate and provide SSO to the proxy server through MDX.

NetScaler Split Tunneling

When planning your SSO and proxy configuration, you must also decide whether to use NetScaler split tunneling. Citrix recommends that you use NetScaler split tunneling only if needed. This section provides a high-level look at how split tunneling works: NetScaler determines the traffic path based on its routing table. When NetScaler split tunneling is on, Secure Hub distinguishes internal (protected) network traffic from Internet traffic, based on the DNS suffix and Intranet applications, and tunnels only the internal network traffic through the VPN tunnel. When NetScaler split tunneling is off, all traffic goes through the VPN tunnel.

- If you prefer to monitor all the traffic due to security considerations, turn off NetScaler split tunneling so that all traffic goes through the VPN tunnel.
- If you use Full VPN Tunnel with PAC, you must disable NetScaler Gateway split tunneling. If split tunneling is on and you configure a PAC file, the PAC file rules override the NetScaler split tunneling rules. A proxy server configured in a traffic policy does not override NetScaler split tunneling rules.

By default, an MDX app uses NetScaler split tunnel settings if the **Network access** policy is set to **Tunneled to the internal network**, which is the default setting for Secure Web. The **Network access** policy default differs for some other XenMobile Apps.

NetScaler Gateway also has a micro VPN reverse split tunnel mode. This configuration supports an exclusion list of IP addresses that aren't tunneled to the NetScaler, but are instead sent by using the device's Internet connection. For more information about reverse split tunneling, see [Configuring Split Tunneling](#) in the NetScaler Gateway documentation.

As of XenMobile 10.3.5, XenMobile includes a **Reverse split tunnel exclusion list**. If you don't want certain websites to tunnel through NetScaler Gateway, you can add a comma-separated list of fully qualified domain names (FQDN) or DNS suffixes that connect by using the local area network (LAN) instead. This list applies only to Secure Browse mode with NetScaler Gateway configured for reverse split tunneling.

Authentication

Jun 21, 2017

In a XenMobile deployment, several considerations come into play when deciding how to configure authentication. This section will help you understand the various factors that affect authentication by discussing the following:

- The main MDX policies, XenMobile client properties and NetScaler Gateway settings involved with authentication.
- The ways these policies, client properties, and settings interact.
- The tradeoffs of each choice.

This article also includes three examples of recommended configurations for increasing degrees of security.

Broadly speaking, stronger security results in a less-optimal user experience, because users have to authenticate more often. How you balance those concerns depends on your organization's needs and priorities. By reviewing the three recommended configurations, you should gain a greater understanding of the interplay of authentication measures available to you, and how to best deploy your own XenMobile environment.

Authentication Modes

Online authentication: Allows users into the XenMobile network. Requires an Internet connection.

Offline authentication: Happens on the device. Users unlock the secure vault and have offline access to items, such as downloaded mail, cached websites, and notes.

Methods of Authentication

Single Factor

LDAP: You can configure a connection in XenMobile to one or more directories, such as Active Directory that are compliant with the Lightweight Directory Access Protocol (LDAP). This is a commonly used method to provide single sign-on (SSO) for company environments. You might opt for Citrix PIN with Active Directory password caching to improve the user experience with LDAP while still providing the security of complex passwords on enrollment, password expiration, and account lockout.

For more details, see [Domain or domain plus STA](#) in the XenMobile documentation.

Client certificate: XenMobile can integrate with industry-standard certificate authorities to use certificates as the sole method of online authentication. XenMobile provides this certificate after user enrollment, which requires either a one-time password, invitation URL, or LDAP credentials. When using a client certificate as the primary method of authentication, a Citrix PIN is required in client certificate-only environments to secure the certificate on the device.

XenMobile supports Certificate Revocation List (CRL) only for a third-party Certificate Authority. If you have a Microsoft CA configured, XenMobile uses NetScaler to manage revocation. When you configure client certificate-based authentication, consider whether you need to configure the NetScaler Certificate Revocation List (CRL) setting, Enable CRL Auto Refresh. This step ensures that the user of a device in MAM-only mode can't authenticate using an existing certificate on the device; XenMobile re-issues a new certificate, because it doesn't restrict a user from generating a user certificate if one is revoked. This setting increases the security of PKI entities when the CRL checks for expired PKI entities.

For a diagram that shows the deployment needed if you plan to use certificate-based authentication for users or if you need to use your enterprise Certificate Authority (CA) for issuing device certificates, see [Reference Architecture for On-Premises Deployments](#).

Two Factor

LDAP + Client Certificate: In the XenMobile environment, this configuration is the best combination of security and user experience, with the best SSO possibilities coupled with security provided by two-factor authentication at NetScaler. Using both LDAP and client certificate provides security with both something users know (their Active Directory passwords) and something they have (client certificates on their devices). Secure Mail (and some other XenMobile Apps) can automatically configure and provide a seamless first-time user experience with client certificate authentication, with a properly configured Exchange client access server environment. For optimal usability, you can combine this option with Citrix PIN and Active Directory password caching.

LDAP + Token: This configuration allows for the classic configuration of LDAP credentials, plus a one-time password, using the RADIUS protocol. For optimal usability, you can combine this option with Citrix PIN and Active Directory password caching.

Important Policies, Settings and Client Properties Involved in Authentication

The following policies, settings, and client properties come into play with the following three recommended configurations:

MDX policies

App passcode: If **On**, a Citrix PIN or passcode is required to unlock the app when it starts or resumes after a period of inactivity. Default is **On**.

To configure the inactivity timer for all apps, set the `INACTIVITY_TIMER` value in minutes in the XenMobile console in **Client Properties** on the **Settings** tab. The default is 15 minutes. To disable the inactivity timer, so that a PIN or passcode prompt appears only when the app starts, set the value to zero.

Note: If you select Secure offline for the Encryption keys policy, this policy is automatically enabled.

Online session required: If **On**, the user must have a connection to the enterprise network and an active session in order to access the app on the device. If **Off**, an active session is not required to access the app on the device. Default is **Off**.

Maximum offline period (hours): Defines the maximum period an app can run without reconfirming app entitlement and refreshing policies from XenMobile. When you set the Maximum offline period, if Secure Hub for iOS has a valid NetScaler Gateway token, the app retrieves new policies for MDX apps from XenMobile without any interruption to users. If Secure Hub does not have a valid NetScaler token, users must authenticate through Secure Hub in order for app policies to update. The NetScaler token may become invalid due to a NetScaler Gateway session inactivity or a forced session time-out policy. When users sign on to Secure Hub again, they can continue running the app.

Users are reminded to sign on at 30, 15, and 5 minutes before the period expires. After expiration, the app is locked until users sign on. Default is **72 hours (3 days)**. Minimum period is 1 hour.

Note: Keep in mind that in a scenario in which users travel often and may use international roaming, the default of 72 hours (3 days) may be too short.

Background services ticket expiration: The time period that a background network service ticket remains valid. When Secure Mail connects through NetScaler Gateway to an Exchange Server running ActiveSync, XenMobile issues a token that Secure Mail uses to connect to the internal Exchange Server. This property setting determines the duration that Secure Mail can use the token without requiring a new token for authentication and the connection to the Exchange Server. When the time limit expires, users must log on again to generate a new token. Default is **168 hours (7 days)**. When this time-out expires, mail notifications will discontinue.

Online session required grace period: Determines how many minutes a user can use the app offline before the Online session required policy prevents them from further use (until the online session is validated). Default is 0 (no grace period).

For more information about MDX Toolkit authentication policies, see [XenMobile MDX Policies for iOS](#) and [XenMobile MDX Policies for Android](#).

XenMobile client properties

Note: Client properties are a global setting that apply to all devices that connect to XenMobile.

Citrix PIN: For a simple sign-on experience, you might choose to enable the Citrix PIN. With the PIN, users do not have to enter other credentials repeatedly, such as their Active Directory user names and passwords. You can configure the Citrix PIN as a standalone offline authentication only, or combine the PIN with Active Directory password caching to streamline authentication for optimal usability. You configure the Citrix PIN in **Settings > Client > Client Properties** in the XenMobile console.

Following is a summary of a few important properties. For more information, see [Client properties](#) in the XenMobile documentation.

ENABLE_PASSCODE_AUTH

Display name: Enable Citrix PIN Authentication

This key allows you to turn on Citrix PIN functionality. With the Citrix PIN or passcode, users are prompted to define a PIN to use instead of their Active Directory password. You should enable this setting if **ENABLE_PASSWORD_CACHING** is enabled or if XenMobile is using certificate authentication.

Possible values: true or false

Default value: false

ENABLE_PASSWORD_CACHING

Display name: Enable User Password Caching

This key lets you allow the users' Active Directory password to be cached locally on the mobile device. When you set this key to true, users are prompted to set a Citrix PIN or passcode. The ENABLE_PASSCODE_AUTH key must be set to true when you set this key to **true**.

Possible values: true or false

Default value: false

PASSCODE_STRENGTH

Display name: PIN Strength Requirement

This key defines the strength of the Citrix PIN or passcode. When you change this setting, users are prompted to set a new Citrix PIN or passcode the next time they are prompted to authenticate.

Possible values: Low, Medium, or Strong

Default value: Medium

INACTIVITY_TIMER

Display name: Inactivity timer

This key defines the time in minutes that users can leave their devices inactive and then access an app without being prompted for a Citrix PIN or passcode. To enable this setting for an MDX app, you must set the App Passcode setting to **On**. If the App Passcode setting is set to **Off**, users are redirected to Secure Hub to perform a full authentication. When you change this setting, the value takes effect the next time users are prompted to authenticate. The default is 15 minutes.

ENABLE_TOUCH_ID_AUTH

Display name: Enable Touch ID Authentication

Allows the use of the fingerprint reader (in iOS only) for offline authentication. Online authentication will still require the primary authentication method.

ENCRYPT_SECRETS_USING_PASSCODE

Display name: Encrypt secrets using Passcode

This key lets sensitive data be stored on the mobile device in a secret vault instead of in a platform-based native store, such as the iOS keychain. This configuration key enables strong encryption of key artifacts, but also adds user entropy (a user-generated random PIN code that only the user knows).

Possible values: true or false

Default value: false

NetScaler Settings

Session time-out: If you enable this setting, NetScaler Gateway disconnects the session if NetScaler detects no network activity for the specified interval. This setting is enforced for users who connect with the NetScaler Gateway Plug-in, Citrix Receiver, Secure Hub, or through a web browser. Default is **1440 minutes**. If you set this value to zero, the setting is disabled.

Forced time-out: If you enable this setting, NetScaler Gateway disconnects the session after the time-out interval elapses no matter what the user is doing. When the time-out interval elapses, there is no action the user can take to prevent the disconnection. This setting is enforced for users who connect with the NetScaler Gateway Plug-in, Citrix Receiver, Secure Hub, or through a web browser. If Secure Mail is using STA, a special NetScaler mode, the Forced time-out setting does not apply to Secure Mail sessions. Default is **1440 minutes**. If you leave this value blank, the setting is disabled.

For more information about time-out settings in NetScaler Gateway, see [Configuring Time-Out Settings](#) in the NetScaler documentation.

For more information on the scenarios that prompt users to authenticate with XenMobile by entering credentials on their devices, see [Authentication Prompt Scenarios](#) in the XenMobile Apps documentation.

Default Configuration Settings

These settings are the defaults provided by the NetScaler for XenMobile wizard, by the MDX Toolkit, and in the XenMobile

console.

Setting	Where to Find the Setting	Default Setting
Session time-out	NetScaler Gateway	1440 minutes
Force time-out	NetScaler Gateway	1440 minutes
Maximum offline period	MDX Policies	72 hours
Background services ticket expiration	MDX Policies	168 hours (7 days)
Online session required	MDX Policies	Off
Online session required grace period	MDX Policies	0
App passcode	MDX Policies	On
Encrypt secrets using passcode	XenMobile client properties	false
Enable Citrix PIN Authentication	XenMobile client properties	false
PIN Strength Requirement	XenMobile client properties	Medium
PIN Type	XenMobile client properties	Numeric
Enable User Password Caching	XenMobile client properties	false
Inactivity Timer	XenMobile client properties	15
Enable Touch ID Authentication	XenMobile client properties	false

Recommended Configurations

This section gives examples of three XenMobile configurations that range from lowest security and optimal user experience, to the highest security and more intrusive user experience. These examples should provide you with helpful reference points to determine where on the scale you want to place your own configuration. Be aware that modifying these settings may require you to alter other settings as well. For instance, the maximum offline period should always be less than the session time-out.

High Security

This configuration, the most convenient to users, provides base-level security.

Setting	Where to Find the Setting	Recommended Setting	Behavior Impact
Session time-out	NetScaler Gateway	10080	Users enter their Secure Hub credentials only when online authentication is required - every 7 days
Force time-out	NetScaler Gateway	No value	Sessions will be extended if there's any activity.
Maximum offline period	MDX Policies	167	Requires policy refresh every week (every 7 days). The hour difference is to allow for refresh ahead of session time-out.
Background services ticket expiration	MDX Policies	240	Time out for STA, which allows for long-lived sessions without a NetScaler Gateway session token. In the case of Secure Mail, making the STA time-out longer than the session time-out avoids having mail notifications stop without prompting the user if they don't open the app before the session expires.
Online session required	MDX Policies	Off	Ensures a valid network connection and NetScaler Gateway session to use apps.
Online session required grace period	MDX Policies	0	No grace period (if you enabled Online Session required).
App passcode	MDX Policies	On	Require passcode for application.
Encrypt secrets using passcode	XenMobile client properties	false	Do not require user entropy to encrypt the vault.
Enable Citrix PIN Authentication	XenMobile client properties	true	Enable Citrix PIN for simplified authentication experience.
PIN Strength Requirement	XenMobile client properties	Low	No password complexity requirements
PIN Type	XenMobile client properties	Numeric	PIN is a numeric sequence.
Enable Password	XenMobile client	true	The user PIN caches and protects the Active Directory password.

Setting	Where to Find the Setting	Recommended Setting	Behavior Impact
Inactivity Timer	XenMobile client properties	90	If user does not use MDX apps or Secure Hub for this period of time, prompt for offline authentication.
Enable Touch ID Authentication	XenMobile client properties	true	Enables Touch ID for offline authentication use cases in iOS.

Higher Security

A more middle-of-the-road approach, this configuration requires users to authenticate more often - every 3 days, at most, instead of 7 - and stronger security. The increased number of authentications lock the container more often, ensuring data security when devices aren't in use.

Setting	Where to Find the Setting	Recommended Setting	Behavior Impact
Session time-out	NetScaler Gateway	4320	Users enter their Secure Hub credentials only when online authentication is required - every 3 days
Force time-out	NetScaler Gateway	No value	Sessions will be extended if there's any activity.
Maximum offline period	MDX Policies	71	Requires policy refresh every 3 days. The hour difference is to allow for refresh ahead of session time-out.
Background services ticket expiration	MDX Policies	168 hours	Time out for STA, which allows for long-lived sessions without a NetScaler Gateway session token. In the case of Secure Mail, making the STA time-out longer than the session time-out avoids having mail notifications stop without prompting the user if they don't open the app before the session expires.
Online session required	MDX Policies	Off	Ensures a valid network connection and NetScaler Gateway session to use apps.
Online session required grace period	MDX Policies	0	No grace period (if you enabled Online Session required).
App passcode	MDX Policies	On	Require passcode for application.
Encrypt secrets using passcode	XenMobile client properties	false	Do not require user entropy to encrypt the vault
Enable Citrix PIN	XenMobile client	true	Enable Citrix PIN for simplified authentication experience.

Setting	Where to Find the Setting	Recommended Setting	Behavior Impact
PIN Strength Requirement	XenMobile client properties	Medium	Enforces medium password complexity rules.
PIN Type	XenMobile client properties	Numeric	PIN is a numeric sequence.
Enable Password Caching	XenMobile client properties	true	The user PIN caches and protects the Active Directory password.
Inactivity Timer	XenMobile client properties	30	If user does not use MDX apps or Secure Hub for this period of time, prompt for offline authentication.
Enable Touch ID Authentication	XenMobile client properties	true	Enables Touch ID for offline authentication use cases in iOS.

Highest Security

This configuration offers the highest level of security but contains significant usability trade-offs.

Setting	Where to Find the Setting	Recommended Setting	Behavior Impact
Session time-out	NetScaler Gateway	1440	Users enter their Secure Hub credentials only when online authentication is required-every 24 hours.
Force time-out	NetScaler Gateway	1440	Online authentication will be strictly required every 24 hours. Activity doesn't extend session life.
Maximum offline period	MDX Policies	23	Requires policy refresh every day.
Background services ticket expiration	MDX Policies	72 hours	Time out for STA, which allows for long-lived sessions without a NetScaler Gateway session token. In the case of Secure Mail, making the STA time-out longer than the session time-out avoids having mail notifications stop without prompting the user if they don't open the app before the session expires.
Online session required	MDX Policies	Off	Ensures a valid network connection and NetScaler Gateway session to use apps.
Online session required grace period	MDX Policies	0	No grace period (if you enabled Online Session required).

	Policies		
Setting	Where to Find the Setting	Recommended Setting	Behavior Impact
Encrypt secrets using passcode	XenMobile client properties	true	A key derived from user entropy protects the vault.
Enable Citrix PIN Authentication	XenMobile client properties	true	Enable Citrix PIN for simplified authentication experience.
PIN Strength Requirement	XenMobile client properties	Strong	High password complexity requirements.
PIN Type	XenMobile client properties	Alphanumeric	PIN is an alphanumeric sequence.
Enable Password Caching	XenMobile client properties	false	Active Directory password is not cached and Citrix PIN will be used for offline authentications.
Inactivity Timer	XenMobile client properties	15	If user does not use MDX apps or Secure Hub for this period of time, prompt for offline authentication.
Enable Touch ID Authentication	XenMobile client properties	false	Disables Touch ID for offline authentication use cases in iOS.

Using Step-Up Authentication

Some apps may require enhanced authentication (for example, a secondary authentication factor, such as a token or aggressive session time-outs). You control this authentication method through an MDX policy. The method also requires a separate virtual server to control the authentication methods (on either the same or on separate NetScaler appliances).

Setting	Where to Find the Setting	Recommended Setting	Behavior Impact
Alternate NetScaler Gateway	MDX Policies	Requires the FQDN and port of the secondary NetScaler appliance.	Allows for enhanced authentication controlled by the secondary NetScaler appliance authentication and session policies.

If a user opens an app that logs on to the alternate NetScaler Gateway instance, all other apps will use that NetScaler Gateway instance for communicating with the internal network. The session will only switch back to the lower security NetScaler Gateway instance when the session times out from the NetScaler Gateway instance with enhanced security.

Using Online Session Required

For certain applications, such as Secure Web, you may want to ensure that users run an app only when they have an

authenticated session and while the device is connected to a network. This policy enforces that option and allows for a grace period so users can finish their work.

Setting	Where to Find the Setting	Recommended Setting	Behavior Impact
Online session required	MDX Policies	On	Ensures device is online and has a valid authentication token.
Online session required grace period	MDX Policies	15	Allows a 15-minute grace period before the user can no longer use apps

Reference Architecture for On-Premises Deployments

Jun 21, 2017

The figures in this article illustrate the reference architectures for the XenMobile deployment on premises. The deployment scenarios include MDM-only, MAM-only, and MDM+MAM as the core architectures, as well as those that include components, such as XenMobile NetScaler Connector, XenMobile Mail Manager, and XenApp and XenDesktop. The figures show the minimal components required for XenMobile.

Use this chart as a general guide for your deployment decisions.

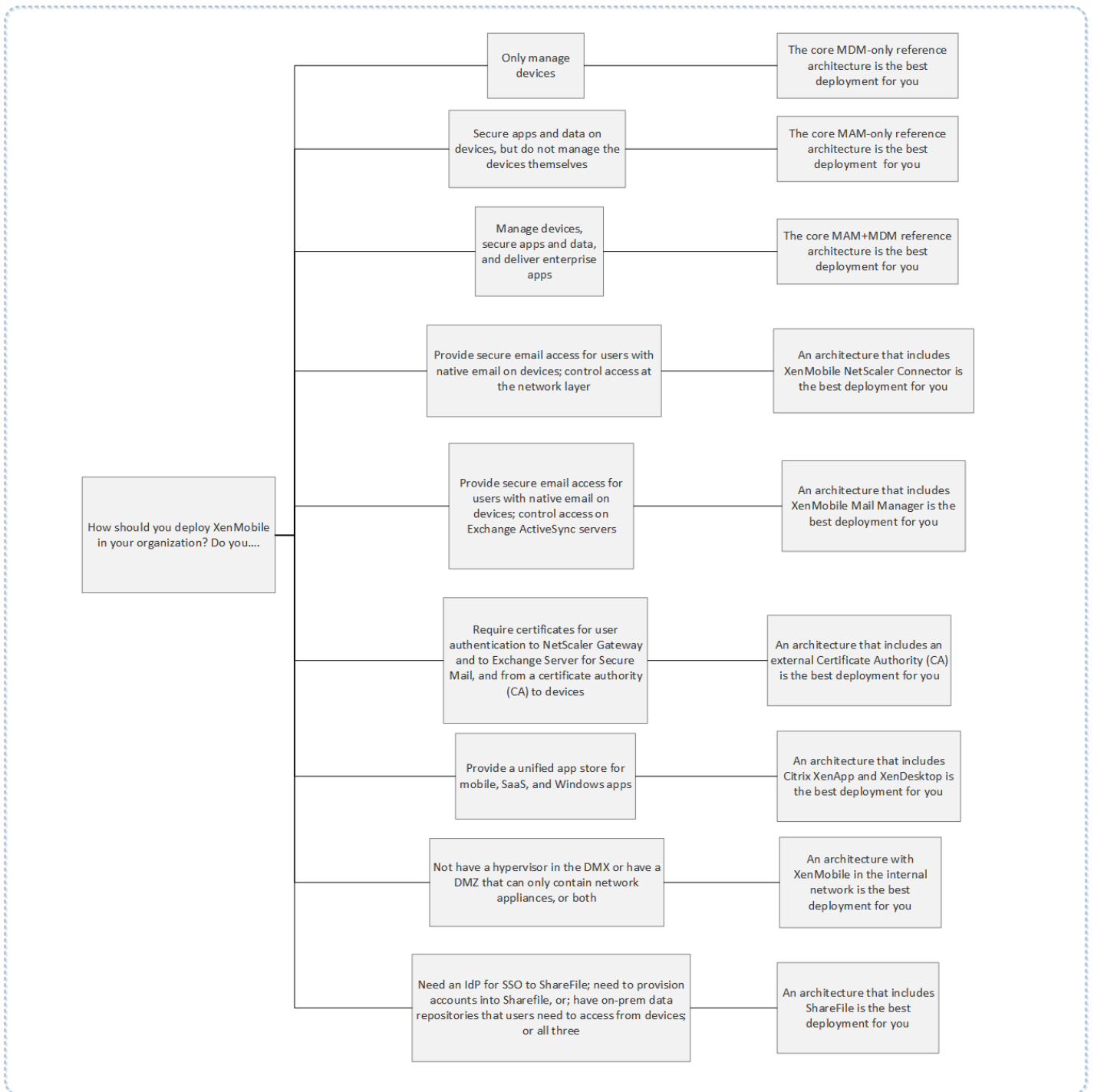

In the figures, the numbers on the connectors represent ports that you must open to allow connections between the components. For a complete list of ports, see [Port requirements](#) in the XenMobile documentation.

Core MDM-Only Reference Architecture

Deploy this architecture if you plan to use only the MDM features of XenMobile. For example, you need to manage a corporate-issued device through MDM in order to deploy device policies, apps and to retrieve asset inventories and be able to carry out actions on devices, such as a device wipe.

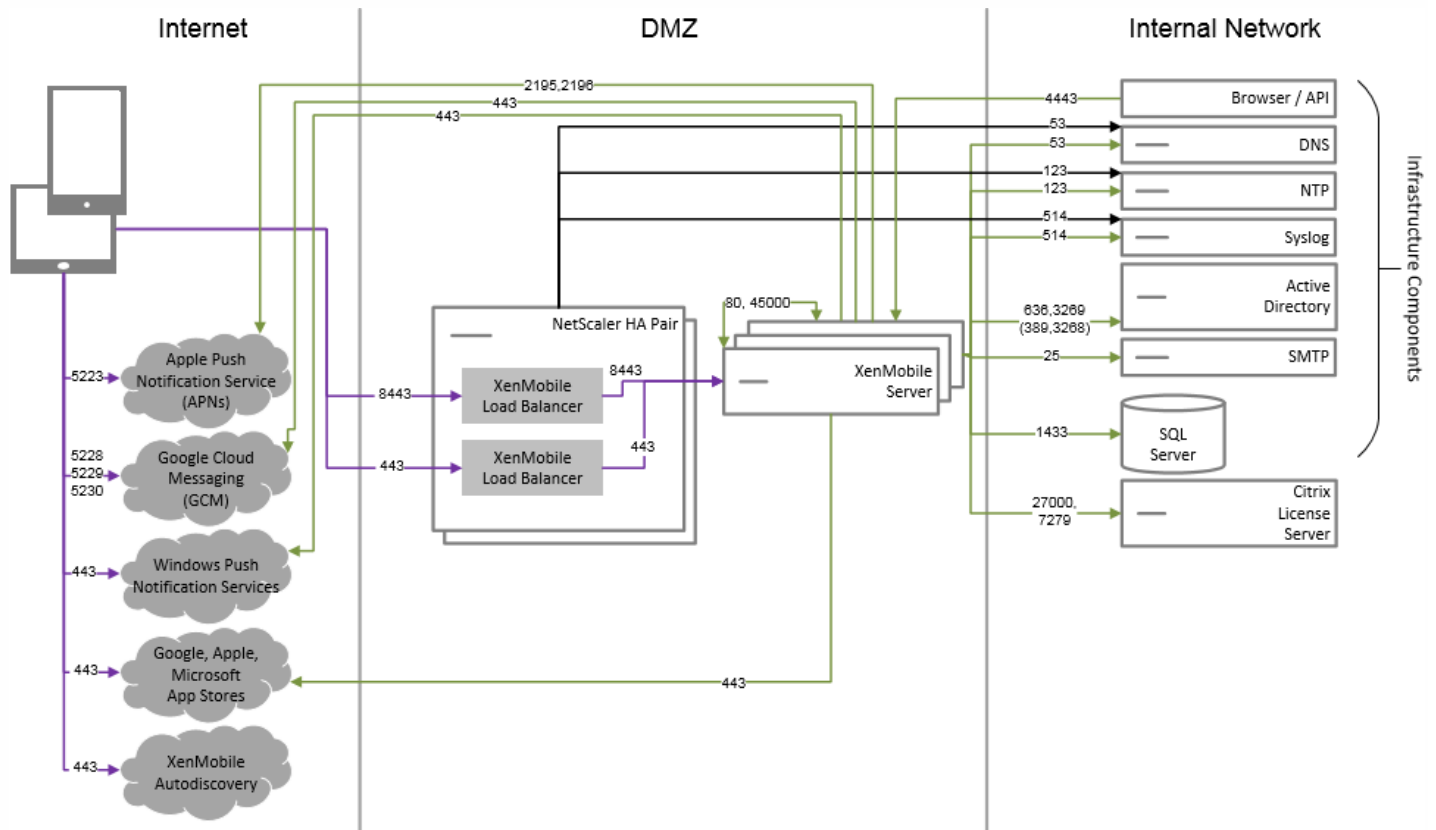

Core MAM-Only Reference Architecture

Deploy this architecture if you plan to use only the MAM features of XenMobile without having devices enroll for MDM. For example, you want to secure apps and data on BYO mobile devices; you want to deliver enterprise mobile apps and be able to lock apps and wipe their data. The devices cannot be MDM enrolled.

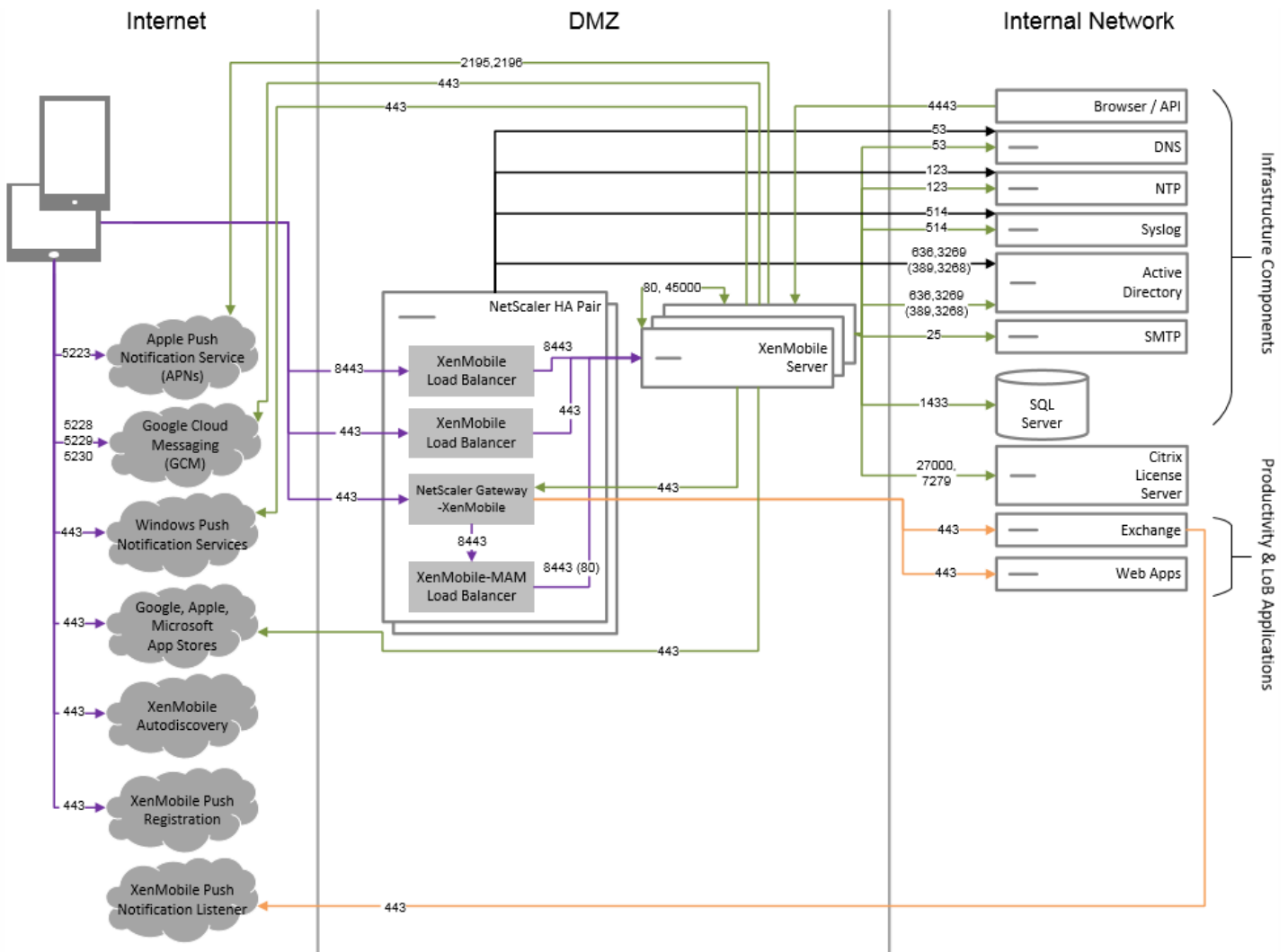

Core MAM+MDM Reference Architecture

Deploy this architecture if you plan to use MDM+MAM features of XenMobile. For example, you want to manage a corporate-issued device via MDM; you want to deploy device policies and apps, retrieve an asset inventory and be able to wipe devices. You also want to deliver enterprise mobile apps and be able to lock apps and wipe the data on devices.

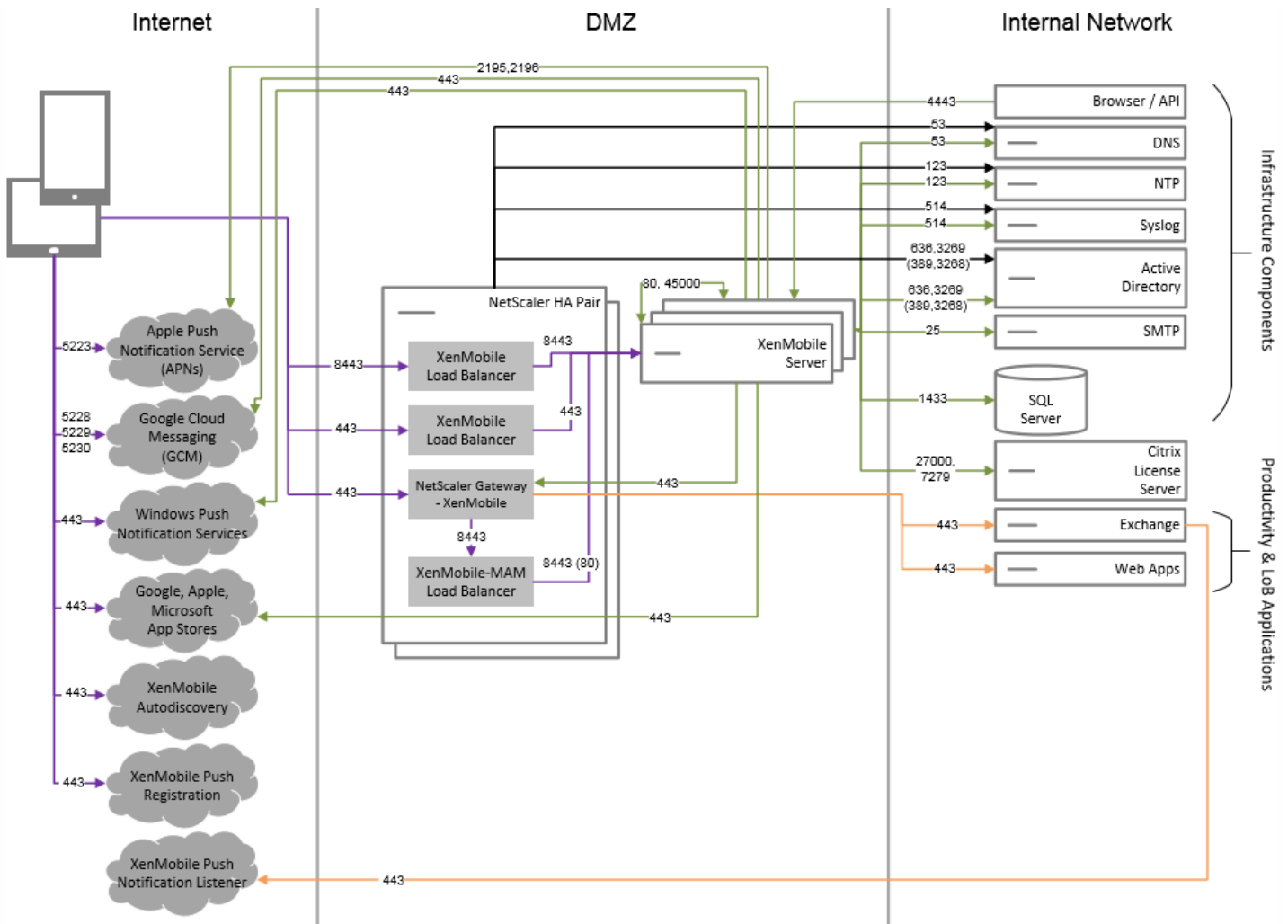

Reference Architecture with XenMobile NetScaler Connector

Deploy this architecture if you plan to use XenMobile NetScaler Connector with XenMobile. For example, you need to provide secure email access to users who use native mobile email apps. These users will continue accessing email via a native app or you may transition them over time to Citrix Secure Mail. Access control needs to occur at the network layer before traffic hits the Exchange Active Sync servers. Even though the diagram shows XenMobile NetScaler Connector deployed in a MDM and MAM architecture, you can also deploy XenMobile NetScaler Connector in the same manner as part of an MDM-only architecture.

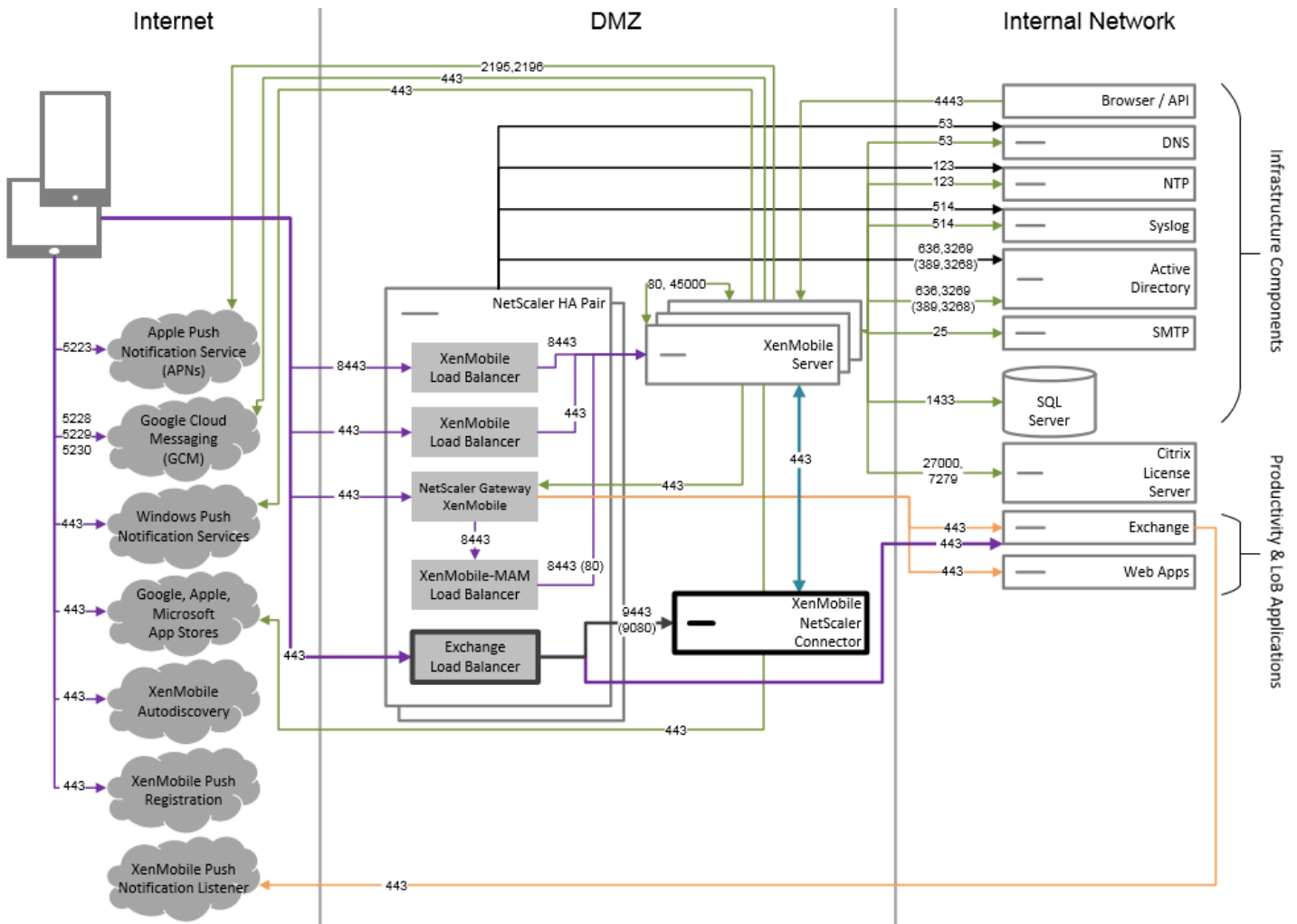

Reference Architecture with XenMobile Mail Manager

Deploy this architecture if you plan to use XenMobile Mail Manager with XenMobile. For example, you want to provide secure email access to users who use native mobile email apps. These users will continue accessing email via a native app or you may transition users over time to Secure Mail. You can achieve access control on the Exchange ActiveSync servers. Although the diagram shows XenMobile Mail Manager deployed in a MDM and MAM architecture, you can also deploy XenMobile Mail Manager in the same manner as part of an MDM-only architecture.

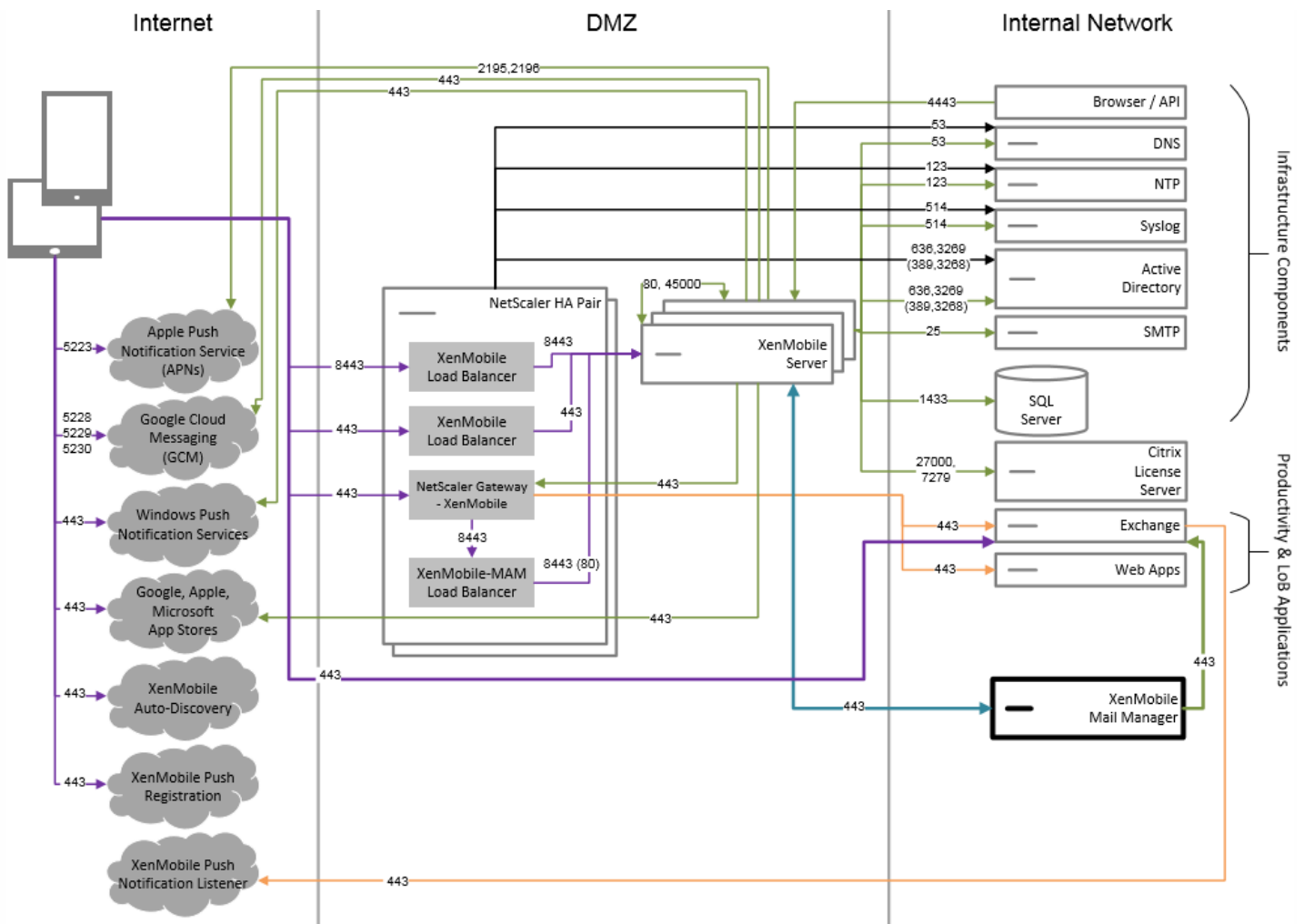

Reference Architecture with External Certificate Authority

A deployment that includes an external certificate authority is recommended to meet one or more of the following requirements:

- You require user certificates for user authentication to NetScaler Gateway (for intranet access).
- You require Secure Mail users to authenticate to Exchange Server by using a user certificate.
- You need to push certificates issued by your corporate Certificate Authority to mobile devices for WiFi access, for example.

Although the diagram shows an external certificate authority deployed in an MDM+MAM architecture, you can also deploy an external Certificate Authority in the same manner as part of an MDM-only or MAM-only architecture.

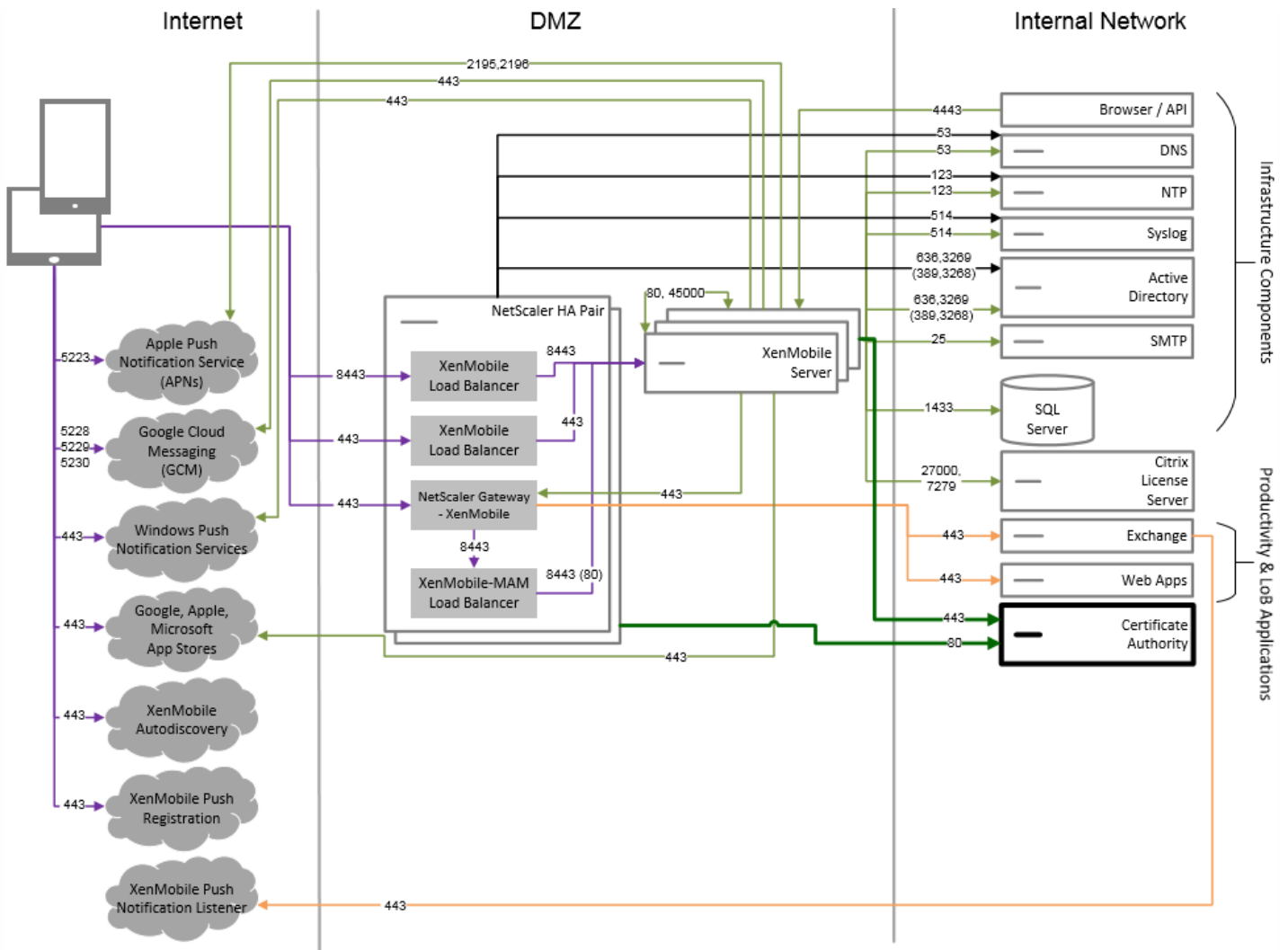

Reference Architecture with XenApp and XenDesktop

Deploy this architecture if you plan to integrate XenApp and XenDesktop with XenMobile. For example, you need to provide a unified app store to mobile users for all types of applications (mobile, SaaS and Windows). Although the diagram shows XenDesktop deployed in a MDM and MAM architecture, you can also deploy XenDesktop in the same manner as part of a MAM-only architecture.

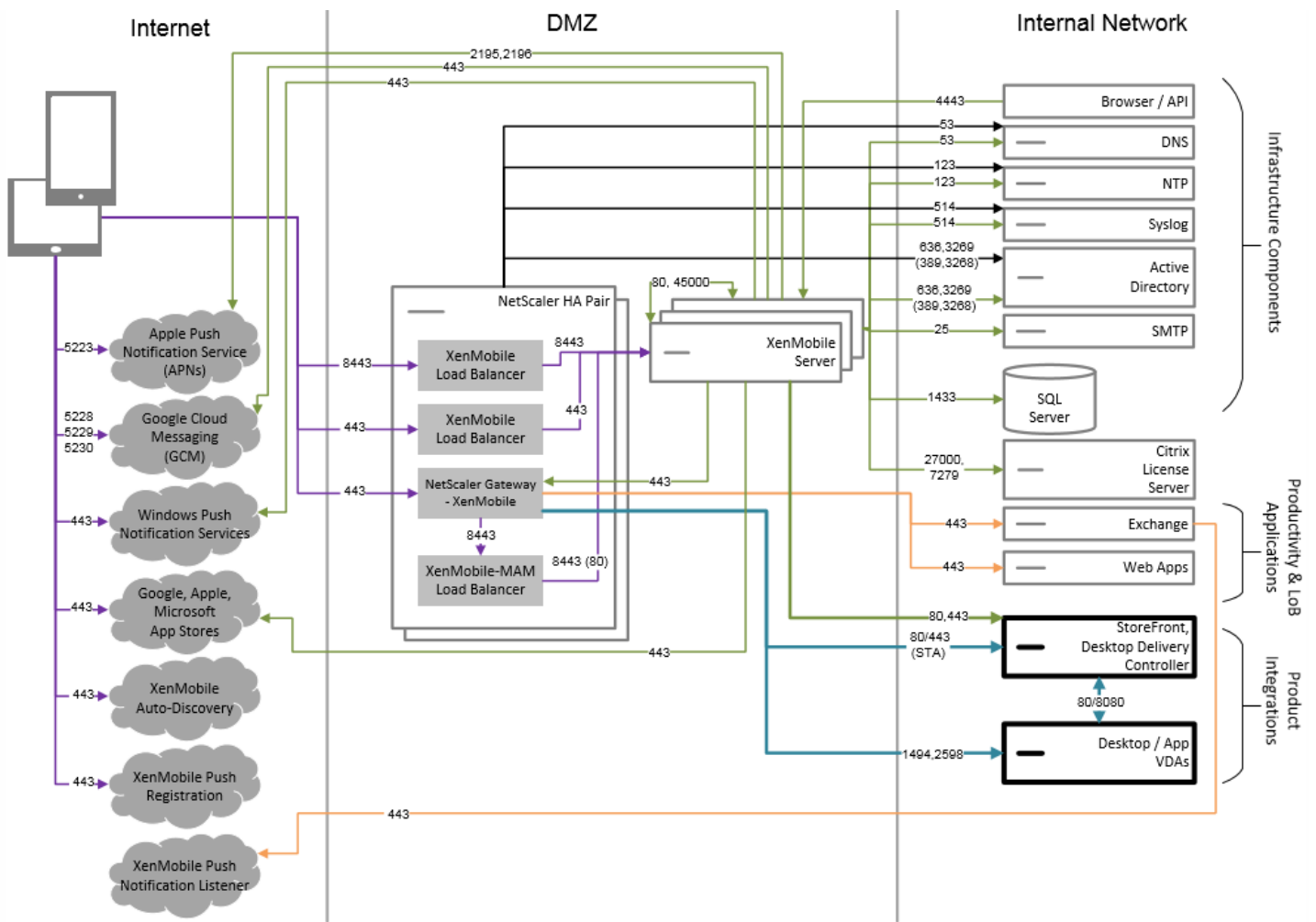

Reference Architecture with XenMobile in the Internal Network

You can deploy an architecture with XenMobile in the internal network to meet one or more of the following requirements:

- You do not have or are not allowed to have a hypervisor in the DMZ.
- Your DMZ can only contain network appliances.
- Your security requirements require the use of SSL Offload.

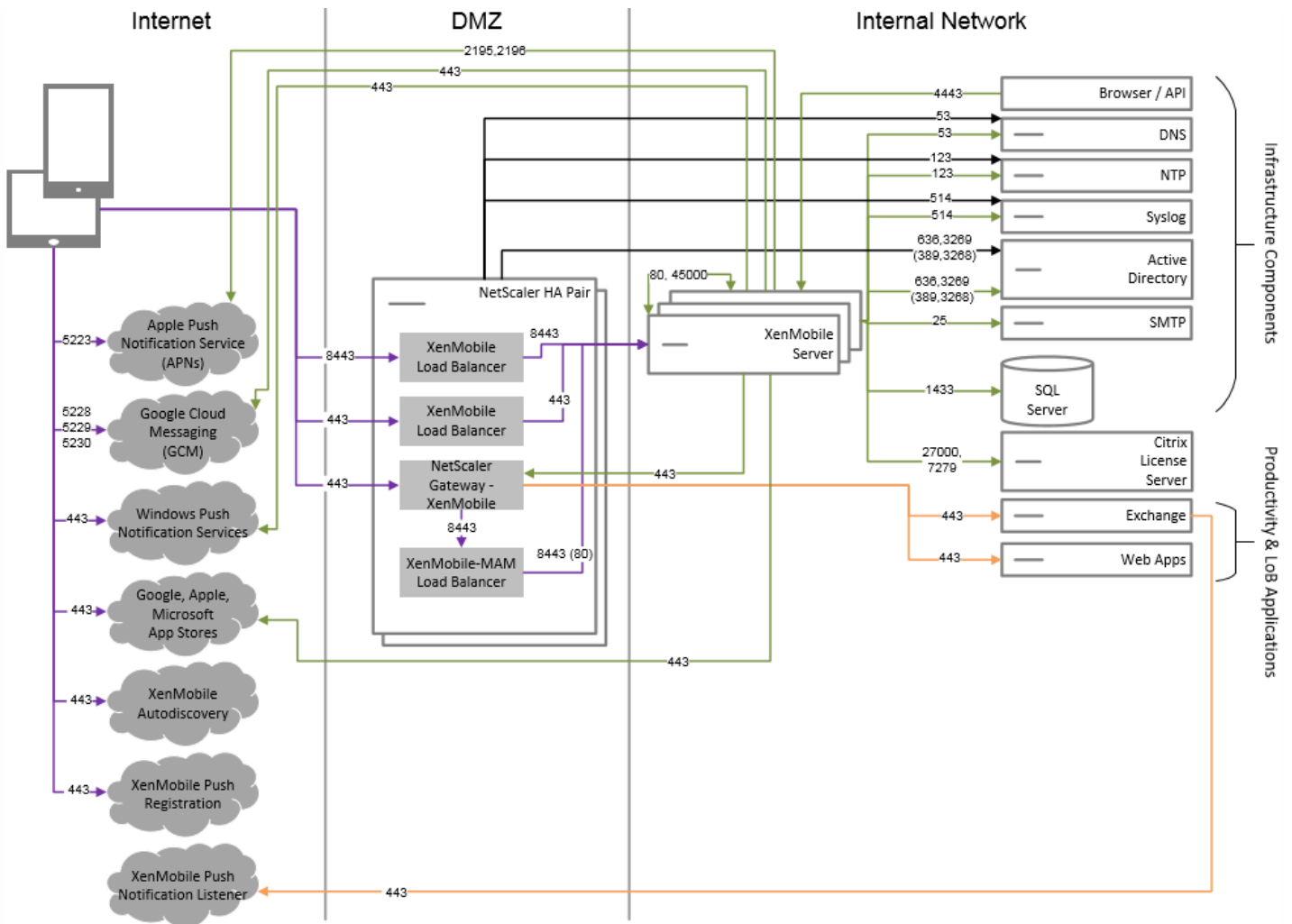

Reference Architecture with ShareFile

Deploy this architecture if you want to integrate ShareFile Enterprise or only StorageZone Connectors with XenMobile. ShareFile Enterprise integration enables you to meet one or more of the following requirements:

- You need an IDP to give users single sign-on (SSO) to ShareFile.com.
- You need a way to provision accounts into ShareFile.com.
- You have on-premises data repositories that need to be accessed from mobile devices.

An integration with only StorageZone Connectors gives users secure mobile access to existing on-premises storage repositories, such as SharePoint sites and network file shares. In this configuration, you don't need to set up a ShareFile subdomain, provision users to ShareFile, or host ShareFile data.

Although the diagram shows ShareFile deployed in a MDM+MAM architecture, you can also deploy ShareFile in the same manner as part of a MAM-only architecture.

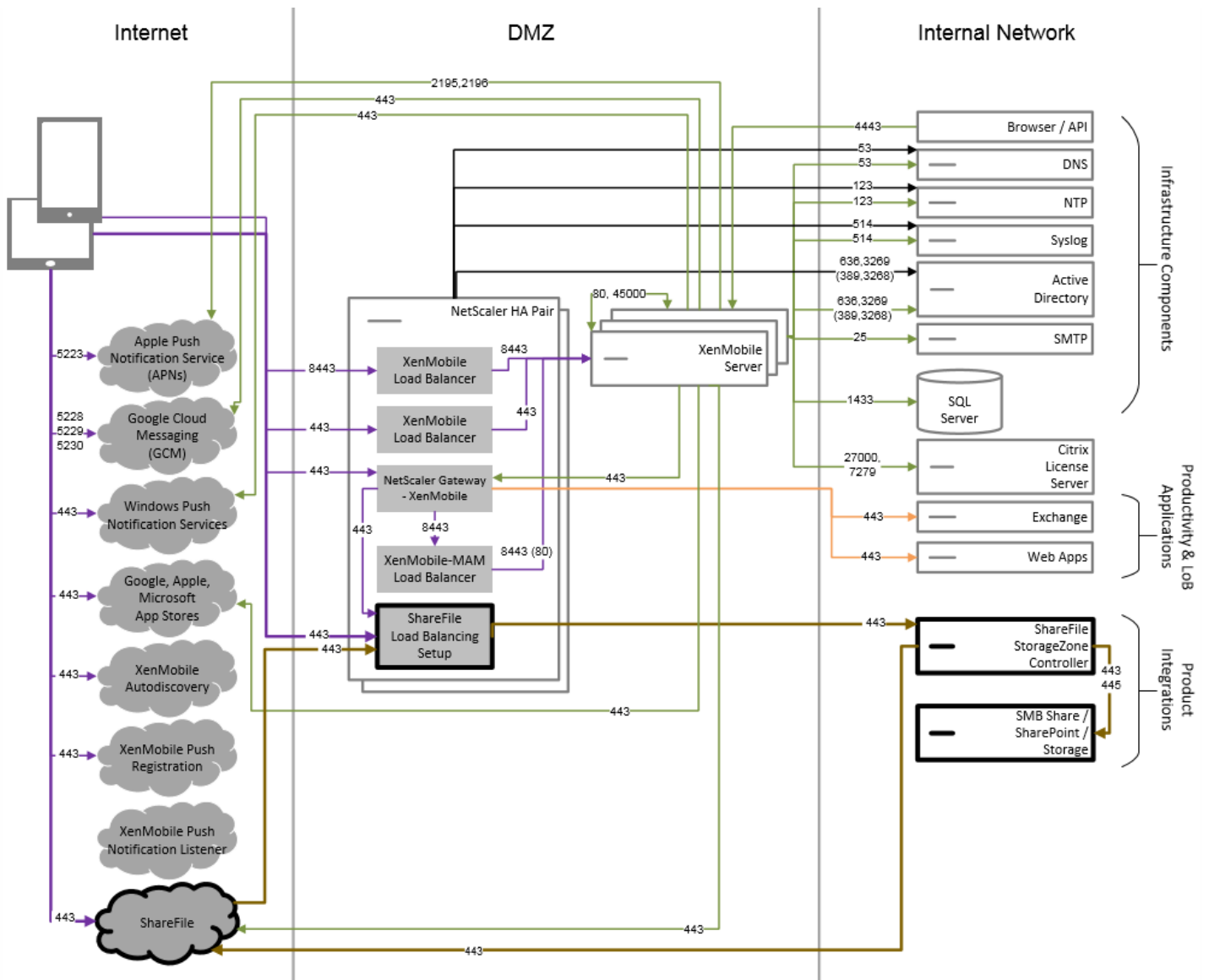

Reference Architecture for Cloud Deployments

Jun 21, 2017

Note

This article applies to XenMobile Service deployments only.

The diagram in this article shows how XenMobile Service integrates with your data center. The other component integrations, such as ShareFile, Certificate Authority, and XenApp and XenDesktop, are available as shown in the preceding core architectures. For details, see [Reference Architecture for On-Premises Deployments](#).

Use of Cloud Connect or eliminates the need to set up complex networking or infrastructure configuration, such as VPNs or IPsec tunnels. If you require a micro VPN, you must use an on-premises NetScaler with Cloud Connector. The following diagram shows NetScaler Gateway hosted on your site.

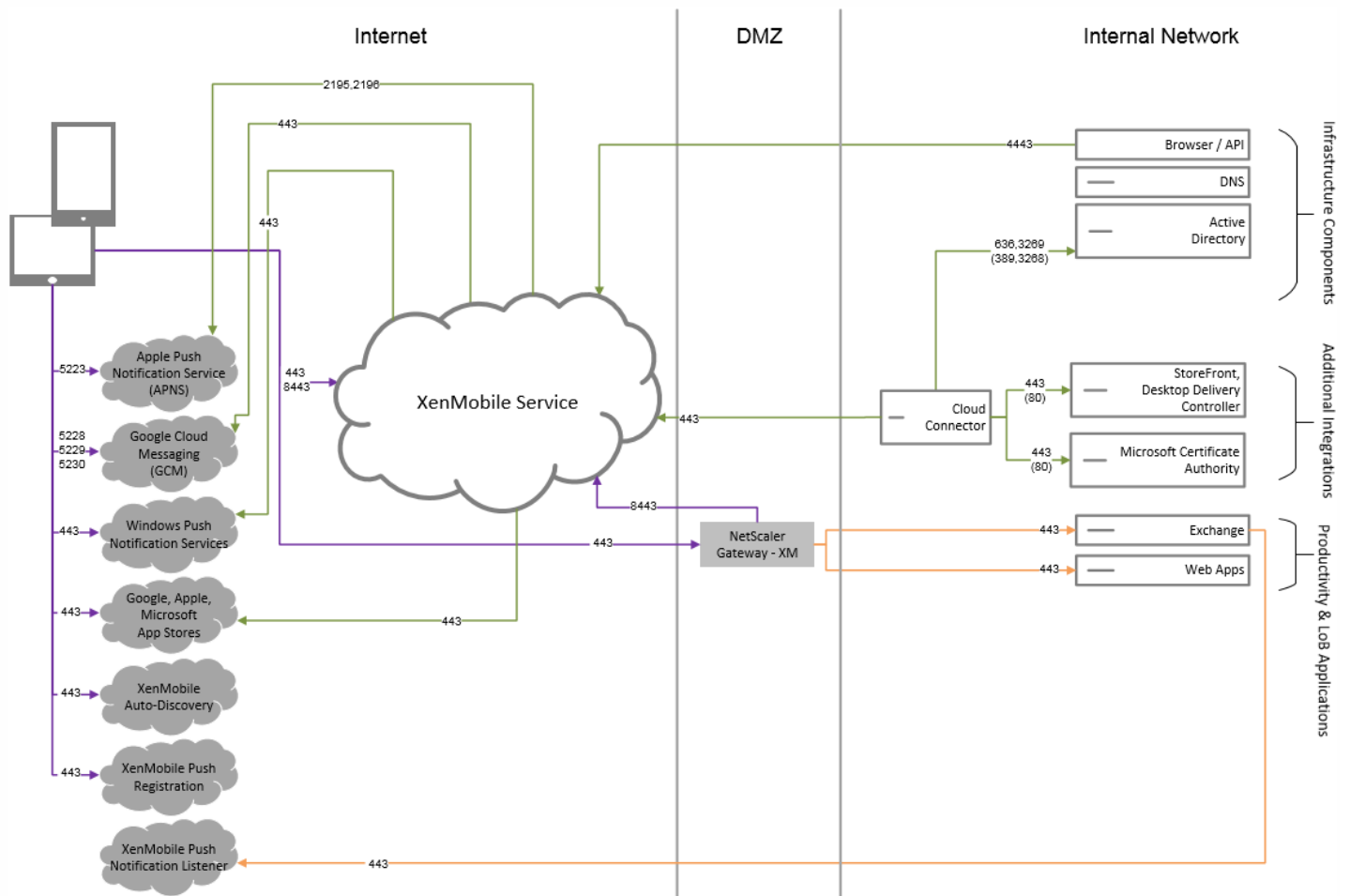

Server Properties

Jun 21, 2017

Server properties are global properties that apply to operations, users, and devices across an entire XenMobile instance. Citrix recommends that you evaluate for your environment the server properties covered in this article. Be sure to consult with Citrix before changing other server properties.

Be aware that a change to some server properties requires a restart of each XenMobile server node. XenMobile notifies you when a restart is required.

Server Property	Notes
Block Enrollment of Rooted Android and Jailbroken iOS Devices	When this property is True , XenMobile blocks enrollments for rooted Android devices and jailbroken iOS devices. Default is False . Recommended setting is True for all security levels.
Enrollment required	<p>This property, which applies only when the XenMobile Server Mode is ENT, specifies whether you require users to enroll in MDM. The property applies to all users and devices for the XenMobile instance. Requiring enrollment provides a higher level of security; however, that decision depends on whether you want to require MDM. By default, enrollment is not required.</p> <p>When this property is False, users can decline enrollment, but may still access apps on their devices through the XenMobile Store. When this property is True, any user who declines enrollment is denied access to apps.</p> <p>If you change this property after users enroll, the users must re-enroll.</p> <p>For a discussion about whether to require MDM enrollment, see Device Management and MDM Enrollment.</p>
XenMobile MDM Self Help Portal console max inactive interval (minutes) Note: This property name reflects the older XenMobile versions. The property controls the XenMobile console max inactive interval.	The number of minutes after which XenMobile logs an inactive user out of the XenMobile console. A time-out of 0 means an inactive user remains logged in. Default is 30 .
Inactivity Timeout in Minutes	The number of minutes after which XenMobile logs out an inactive user who used the XenMobile server Public API to access the XenMobile console or any third-party app. A time-out value of 0 means an inactive user remains logged in. For third-party apps that access the API, remaining logged in is typically necessary. Default is 5 .

<p>iOS Device Management Enrollment Install Root CA if Required</p>	<p>When this property is True, XenMobile checks if the user has the root CA installed on the device and, if the root certificate is missing, installs it. A third-party public certificate trusted by iOS is required. Default is True.</p> <p>If you are using trusted certificates and the iOS device trusts the issuer, setting this property to False improves the MDM user enrollment experience because Secure Hub doesn't prompt the user to install another certificate and enter their PIN. However, we don't recommend setting the property to False if you are using a self-signed SSL Listener certificate on the XenMobile server.</p>
<p>VPP baseline interval</p>	<p>The VPP baseline interval sets the minimum interval that XenMobile re-imports VPP licenses from Apple. Refreshing license information ensures that XenMobile reflects all changes, such as when you manually delete an imported app from VPP. By default, XenMobile refreshes the VPP license baseline a minimum of every 720 minutes.</p> <p>If you have a large number of VPP licenses installed (for example, more than 50,000), Citrix recommends that you increase the baseline interval to reduce the frequency and overhead of importing licenses. If you expect frequent VPP license changes from Apple, Citrix recommends that you lower the value to keep XenMobile updated with the changes. The minimum interval between two baselines is 60 minutes. Because the cron job runs in the background every 60 minutes, if the VPP baseline interval is 60 minutes, the interval between baselines could be delayed up to 119 minutes.</p>

Some server properties help improve performance and stability. For details, see [Tuning XenMobile Operations](#).

Device and App Policies

Jun 22, 2017

Note

This section applies to XenMobile Service and XenMobile on-premises deployments.

XenMobile device and app policies enable you to optimize a balance between factors, such as:

- Enterprise security
- Corporate data and asset protection
- User privacy
- Productive and positive user experiences

The optimum balance between those factors can vary. For example, highly regulated organizations, such as finance, require stricter security controls than other industries, such as education and retail, in which user productivity is a primary consideration.

You can centrally control and configure policies based on users' identity, device, location, and connectivity type to restrict malicious usage of corporate content. In the event a device is lost or stolen, you can disable, lock, or wipe business applications and data remotely. The overall result is a solution that increases employee satisfaction and productivity, while ensuring security and administrative control.

The primary focus of this article is the many device and app policies related to security.

Policies That Address Security Risks

XenMobile device and app policies address many situations that may pose a security risk, such as the following:

- When users try to access apps and data from untrusted devices and unpredictable locations.
- When users pass data from device to device.
- When an unauthorized user tries to access data.
- When a user who has left the company had used their own device (BYOD).
- When a user misplaces a device.
- When users need to access the network securely at all times.
- When users have their own device managed and you need to separate work data from personal data.
- When a device is idle and requires verification of user credentials again.
- When users copy and paste sensitive content into unprotected email systems.
- When users receive email attachments or web links with sensitive data on a device that holds both personal and company accounts.

Those situations relate to two main areas of concern when protecting company data, which are when data is:

- At rest
- In transit

How XenMobile Protects Data at Rest

Data stored on mobile devices is referred to as data at rest. The mobile application management (MAM) capabilities in XenMobile enable complete management, security, and control over XenMobile Apps, MDX-enabled apps, and their associated data. The Worx App SDK, which enables apps for XenMobile deployment, leverages Citrix MDX app container technology to separate corporate apps and data from personal apps and data on the user's mobile device. This allows you to secure any custom developed, third-party, or BYO mobile app with comprehensive policy-based controls.

In addition to an extensive MDX policy library, XenMobile also includes app-level encryption. XenMobile separately encrypts data stored within any MDX-enabled app without requiring a device PIN code and without requiring that you manage the device to enforce the policy.

Policies and the Worx App SDK enable you to:

- Separate business and personal apps and data in a secure mobile container.
- Secure apps with encryption and other mobile Data Loss Prevention (DLP) technologies.

MDX policies provide many operational controls, so you can enable seamless integration between MDX-wrapped apps, while also controlling all communication. In this way, you can enforce policies, such as ensuring that data only is accessible by MDX-enabled apps.

Beyond device and app policy control, the best way to safeguard data at rest is encryption. XenMobile adds a layer of encryption to any data stored in an MDX-enabled app, giving you policy control over features such as public file encryption, private file encryption, and encryption exclusions. The Worx App SDK uses FIPS 140-2 compliant AES 256-bit encryption with keys stored in a protected Citrix Secret Vault. For information about XenMobile encryption and iOS 9, see "iOS 9 Compatibility" in [About the MDX Toolkit](#) and "Data Encryption and iOS 9" in [Best Practices for iOS Apps](#).

How XenMobile Protects Data in Transit

Data on the move between your user's mobile devices and your internal network is referred to as data in transit. MDX app container technology provides application-specific VPN access to your internal network through NetScaler Gateway.

Consider the situation where an employee wants to access the following resources residing in the secure enterprise network from a mobile device: the corporate email server, an SSL-enabled web application hosted on the corporate intranet, and documents stored on a file server or Microsoft SharePoint. MDX enables access to all these enterprise resources from mobile devices through an application-specific micro VPN. Each device has its own dedicated micro VPN tunnel.

Micro VPN functionality does not require a device-wide VPN, which can compromise security on untrusted mobile devices. As a result, the internal network is not exposed to malware or attacks that could infect the entire corporate system. Corporate mobile apps and personal mobile apps are able to coexist on one device.

To offer even stronger levels of security, you can configure MDX-enabled apps with an Alternate NetScaler Gateway policy, used for authentication and for micro VPN sessions with an app. You can use an Alternate NetScaler Gateway with the Online session required policy to force apps to reauthenticate to the specific gateway. Such gateways would typically have different (higher assurance) authentication requirements and traffic management policies.

In addition to security features, micro VPN also offers data optimization techniques, including compression algorithms to ensure that only minimal data is transferred and that the transfer is done in the quickest time possible, thereby improving user experience, which is a key success factor in mobile project success.

You should reevaluate your device policies periodically, such as in these situations:

- When a new version of XenMobile includes new or updated policies due to the release of device operating system updates.
- When you add a new device type. Although many policies are common to all devices, each device has a set of policies specific to its operating system. As a result, you may find differences between iOS, Android, and Windows devices, and even between different manufacturers' devices running Android.
- To keep XenMobile operation in sync with enterprise or industry changes, such as new corporate security policies or compliance regulations.
- When a new version of MDX Toolkit includes new or updated policies.
- When you add or update an app.
- When you need to integrate new workflows for your users as a result of new apps or new requirements.

App Policies and Use Case Scenarios

Although you can choose which apps are available through Secure Hub, you might also want to define how those apps interact with XenMobile. If you want users to authenticate after a certain time period passes or you want to provide users offline access to their information, you do so through app policies. The following list includes some of the policies and discusses how you might use them. For a list of all MDX policies per platform, see [MDX Policies at a Glance](#).

Device passcode

Why use this policy: Enable the Device passcode policy to enforce that a user can access an MDX app only if the device has a device PIN enabled. This feature, for iOS 9 devices, ensures use of iOS encryption at the device level and for the MDX container.

User example: Enabling this policy means that the user must set a PIN code on their iOS device before they can access the MDX app.

App passcode

Why use this policy: Enable the App passcode policy to have Secure Hub prompt a user to authenticate to the managed app before they can open the app and access data. The user might authenticate with their Active Directory password, Citrix PIN, or iOS TouchID, depending what you configure under Client Properties in your XenMobile Server Settings. You can set an inactivity timer in Client Properties so that, with continued use, Secure Hub doesn't prompt the user to authenticate to the managed app again until the timer expires.

The app passcode differs from a device passcode in that, with a device passcode policy pushed to a device, Secure Hub prompts the user to configure a passcode or PIN, which they must unlock before they can gain access to their device when they turn on the device or when the inactivity timer expires. For more information, see [Authentication in XenMobile](#).

User example: When opening the Citrix Secure Web application on the device, the user must enter their Citrix PIN

before they can browse web sites if the inactivity period is expired.

Online session required

Why use this policy: If an application requires access to a web app (web service) to run, enable this policy so that XenMobile prompts the user to connect to the enterprise network or have an active session before using the app.

User example: When a user attempts to open an MDX app that has the Online session required policy enabled, they can't use the app until they connected to the network using a cellular or wifi service.

Maximum offline period

Why use this policy: Use this policy as an additional security option, to ensure that users can't run an app offline for long time periods without reconfirming app entitlement and refreshing policies from XenMobile.

User example: If you configure an MDX app with a Maximum offline period, the user can open and use the app offline until the offline timer period expires. At that point, the user must connect back to the network via cellular or wifi service and reauthenticate, if prompted.

App update grace period (hours)

Why use this policy: The app update grace period is the time available to the user before they must update an app that has a newer version released in the XenMobile Store. At the point of expiry, the user must update the app before they can gain access to the data in the app. When setting this value, keep in mind the needs of your mobile workforce, particularly those who might experience long periods offline when travelling internationally.

User example: You load a new version of Secure Mail in the XenMobile Store and then set an app update grace period of 6 hours. All Secure Mail users will see a message asking them to update their Secure Mail app, until the 6 hours expires. When the 6 hours expires, Secure Hub routes users to the XenMobile Store.

Active poll period (minutes)

Why use this policy: The active poll period is the interval at which XenMobile checks apps for when to perform security actions, such as App Lock and App Wipe.

User example: If you set the Active poll period policy to 60 minutes, when you send the App Lock command from XenMobile to the device, the lock occurs within 60 minutes of when the last poll took place.

Why use these policies: XenMobile includes a secret vault with a strong encryption layer that Secure Hub and other XenMobile Apps use to persist their sensitive data, such as passwords and encryption keys, on the device without depending on the platform native keystores. As a result, if the device becomes compromised in any way, corporate data remains encrypted in the MDX container and XenMobile obfuscates the data before transferring it outside of the container.

User example: If the device owner did not set a device PIN or the device PIN becomes compromised, the corporate data inside the Secure Hub container remains secure.

Why use these policies: Use App Interaction policies to control the flow of documents and data from MDX apps to other apps on the device. For example, you can prevent a user from moving data to their personal apps outside of the container or from pasting data from outside of the container into the containerized apps.

User example: You set an App interaction policy to Restricted, which means a user can copy text from Secure Mail to Secure Web but can't copy that data to their personal Safari or Chrome browser that is outside the container. In addition, a user can open an attached document from Secure Mail into ShareFile or Quick Edit but can't open the attached document in their own personal file viewing apps that are outside the container.

Why use these policies: Use App Restriction policies to control what features users can access from an MDX app while it is open. This helps to ensure that no malicious activity can take place while the app is running. The App Restriction policies vary slightly between iOS and Android. For example, in iOS you can block access to iCloud while the MDX app is running. In Android, you can stop NFC use while the MDX app is running.

User example: If you enable the App Restriction policy to block dictation on iOS in an MDX app, the user can't use the dictate function on the iOS keyboard while the MDX app is running. Thus, data users dictate isn't passed to the unsecure third-party cloud dictation service. When the user opens their personal app outside of the container, the dictate option remains available to the user for their personal communications.

Why use these policies: Use the App Network Access policies to provide access from an MDX app in the container on the device to data sitting inside your corporate network. For the Network access policy, set the **Tunneled to the internal network** option to automate a micro VPN from the MDX app through the NetScaler to a back-end web service or datastore.

User example: When a user opens an MDX app, such as Secure Web, that has tunneling enabled, the browser opens and launches an intranet site without the user needing to start a VPN. The Secure Web app automatically accesses the internal site using micro VPN technology.

Why use these policies: The policies that control app geolocation and geofencing include center point Longitude, center point Latitude, and Radius. Those policies contain access to the data in the MDX apps to a specific geographical area. The policies define a geographic area by a radius of latitude and longitude coordinates. If a user attempts to use an app outside of the defined radius, the app remains locked and the user cannot access the app data.

User example: A user can access merger and acquisition data while they are in their office location. When they move outside of their office location, this sensitive data becomes inaccessible.

Background network services

Why use this policy: Background network services in Secure Mail leverage Secure Ticket Authority (STA), which is effectively a SOCKS5 proxy to connect through NetScaler Gateway. STA supports long-lived connections and provides better battery life compared to micro VPN. Thus, STA is ideal for mail that connects constantly. Citrix recommends that you configure these settings for Secure Mail. The NetScaler for XenMobile wizard automatically sets up STA for Secure Mail.

User example: When STA isn't enabled and an Android user opens Secure Mail, they are prompted to open a VPN, which remains open on the device. When STA is enabled and the Android user opens Secure Mail, Secure Mail connects seamlessly with no VPN required.

Default sync interval

Why use this policy: This setting specifies the default days of email that synchronize to Secure Mail when the user accesses Secure Mail for the first time. Be aware that 2 weeks of email takes longer to sync than 3 days and prolongs the setup process for the user.

User example: If the default sync interval is set to 3 days when the user first sets up Secure Mail, they can see any emails in their Inbox that they received from the present to 3 days in the past. If a user wants to see emails that are older than 3 days, they can do a search. Secure Mail then shows the older emails stored on the server. After installing Secure Mail, each user can change this setting to better suit their needs.

Device Policies and Use Case Behavior

Device policies, sometimes referred to as MDM policies, determine how XenMobile works with devices. Although many policies are common to all devices, each device has a set of policies specific to its operating system. The following list includes some of the device policies and discusses how you might use them. For a list of all device policies, see the articles under [Device policies](#).

App inventory policy

Why use this policy: Deploy the App inventory policy to a device if you need to see the apps installed by a user. If you don't deploy the App inventory policy, you can see only the apps that a user installed from the XenMobile Store and not any personally installed applications. You must use this policy if you want to blacklist certain apps from running on corporate devices.

User example: A user with an MDM-managed device cannot disable this functionality. The user's personally installed applications are visible to XenMobile administrators.

App lock policy

Why use this policy: The App Lock policy, for Android, allows you to blacklist or whitelist apps. For example, by whitelisting apps you can configure a kiosk device. Typically, you deploy the App lock policy only to corporate owned devices, because it limits the apps that users can install. You can set an override password to provide user access to blocked apps.

User example: Suppose that you deploy an App lock policy that blocks the Angry Birds app. The user can install the Angry Birds app from Google Play, yet when they open the app a message advises them that their administrator blocked the app.

Connection scheduling policy

Why use this policy: You must use the Connection scheduling policy so that Android and Windows Mobile devices can connect back to XenMobile for MDM management, app push, and policy deployment. If you do not deploy this policy and have not enabled Google Firebase Cloud Messaging (FCM), devices will not connect back to XenMobile. It is

important to deploy this policy in the base package for enrolling devices. The Scheduling options are as follows:

Always - Keeps the connection alive permanently. Citrix recommends this option for optimized security. When you choose **Always**, also use the Connection timer policy to ensure that the connection is not draining the battery. By keeping the connection alive, you can push security commands like wipe or lock to the device on-demand. You must also select the Deployment Schedule option **Deploy for always-on connection** in each policy you deploy to the device.

Never - Connects manually. Citrix does not recommend this option for production deployments because the **Never** option prevents you from deploying security policies to devices; thus, users never receive any new apps or policies.

Every - Connects at the designated interval. When this option is in effect and you send a security policy, such as a lock or a wipe, XenMobile processes the policy on the device the next time the device connects.

Define schedule - When enabled, XenMobile attempts to reconnect the user's device to the XenMobile server after a network connection loss and monitors the connection by transmitting control packets at regular intervals within the timeframe you define.

User example: You want to deploy a passcode policy to enrolled devices. The scheduling policy ensures that the devices connect back to the server at a regular interval to collect the new policy.

Credentials Policy

Why use this policy: Often used in conjunction with a WiFi policy, the Credentials policy lets you deploy certificates for authentication to internal resources that require certificate authentication.

User example: You deploy a WiFi policy that configures a wireless network on the device. The WiFi network requires a certificate for authentication. The Credentials policy deploys a certificate that is then stored in the operating system keystore. The user can then select the certificate when connected to the internal resource.

Exchange policy

Why use this policy: With XenMobile, you have two options to deliver Microsoft Exchange ActiveSync email.

Secure Mail app - Deliver email by using the Secure Mail app that you distribute from the public app store or the XenMobile Store.

Native email app - Use the Exchange policy to enable ActiveSync email for the native email client on the device. With the Exchange policy for native email, you can use macros to populate the user data from their Active Directory attributes, such as `${user.username}` to populate the user name and `${user.domain}` to populate the user domain.

User example: When you push the Exchange policy, you send Exchange Server details to the device. Secure Hub then prompts the user to authenticate and email begins to sync.

Location policy

Why use this policy: The Location policy lets you geolocate devices on a map, if the device has GPS enabled for Secure Hub. After you deploy this policy and then send a locate command from the XenMobile server, the device responds back with the location coordinates.

User example: When you deploy the location policy and GPS is enabled on the device, if users misplace their device,

they can log on to the XenMobile Self Help Portal and choose the locate option to see the location of their device on a map. Note that the user makes the choice to allow Secure Hub to use location services. You cannot enforce the use of location services when users enroll a device themselves. Another consideration for using this policy is the effect on battery life.

Passcode policy

Why use this policy: The passcode policy allows you to enforce a PIN code or password on a managed device. This passcode policy allows you to set the complexity and time-outs for the passcode on the device.

User example: When you deploy a passcode policy to a managed device, Secure Hub prompts the user to configure a passcode or PIN, which they must unlock before they can gain access to their device when they turn on the device or when the inactivity timer expires.

Profile removal policy

Why use this policy: Suppose that you deploy a policy to a group of users and later need to remove that policy from a subset of the users. You can remove the policy for selected users by creating a Profile removal policy and using deployment rules to deploy the Profile removal policy only to specified user names.

User example: When you deploy a Profile removal policy to user devices, users might not notice the change. For example, if the Profile removal policy removes a restriction that disabled the device camera, the user won't know that camera use is now allowed. Consider letting users know when changes affect their user experience.

Restrictions policy

Why use this policy: The restriction policy gives you many options to lock down and control features and functionality on the managed device. You can enable hundreds of restriction options for supported devices, from disabling the camera or microphone on a device to enforcing roaming rules and access to third-party services like app stores.

User example: If you deploy a restriction to an iOS device, the user may not be able to access iCloud or the iTunes store.

Terms and conditions policy

Why use this policy: You might need to advise users of the legal implications of having their device managed. In addition, you may want to ensure that users are aware of the security risks when corporate data is pushed to the device. The custom Terms and Conditions document allows you to publish rules and notices before the user enrolls.

User example: A user sees the Terms and Conditions information during the enrollment process. If they decline to accept the conditions stated, the enrollment process ends and they cannot access corporate data. You can generate a report to provide to HR/Legal/Compliance teams to show who accepted or declined the terms.

VPN policy

Why use this policy: Use the VPN policy to provide access to backend systems using older VPN Gateway technology. The policy supports a number of VPN providers, including Cisco AnyConnect, Juniper, as well as Citrix VPN. It is also possible to link this policy to a CA and enabled VPN on-demand, if the VPN gateway supports this option.

User example: With the VPN policy enabled, a user's device opens a VPN connection when the user accesses an internal domain.

Webclip policy

Why use this policy: Use the Webclip policy if you want to push to devices an icon that opens directly to a website. A webclip contains a link to a website and can include a custom icon. On a device a webclip looks like an app icon.

User example: A user can click on a webclip icon to open an internet site that provides services they need to access. Using a web link is more convenient than needing to open a browser app and type a link address.

WiFi policy

Why use this policy: The WiFi policy lets you deploy WiFi network details, such as the SSID, authentication data, and configuration data, to a managed device.

User example: When you deploy the WiFi policy, the device automatically connects to the WiFi network and authenticates the user so they can gain access to the network.

Windows Information Protection policy

Why use this policy: Use the Windows Information Protection (WIP) policy to protect against the potential leakage of enterprise data. You can specify the apps that require Windows Information Protection at the enforcement level you set. For example, you can block any inappropriate data sharing or warn about inappropriate data sharing and allow users to override the policy. You can run WIP silently while logging and permitting inappropriate data sharing.

User example: Suppose that you configure the WIP policy to block inappropriate data sharing. If a user copies or saves a protected file to a non-protected location, a message similar to the following appears: You can't place work protected content in this location.

XenMobile Store policy

Why use this policy: The XenMobile Store is a unified app store where administrators can publish all the corporate apps and data resources needed by their users. An administrator can add Web apps, SaaS apps, MDX wrapped apps, Citrix productivity apps, native mobile apps such as .ipa or .apk files, iTunes and Google play apps, web links, and XenApp and XenDesktop apps published using Citrix StoreFront.

User example: After a user enrolls their device into XenMobile, they access the XenMobile Store through the Citrix Secure Hub app. The user can then see all the corporate apps and services available to them. Users can click on an app to install it, access the data, rate and review the app, and download app updates from the XenMobile Store.

User Enrollment Options

Jun 22, 2017

Note: This section applies to XenMobile Service and XenMobile on-premises deployments.

You can have users enroll their devices in XenMobile in a number of ways. Before considering the specifics, you must decide if the devices in your environment will enroll in Enterprise mode (MDM+MAM), MDM mode, or MAM mode (also referred to as MAM-only mode). For more information about the management modes, see [Management Modes](#).

At the highest level, there are four enrollment options:

- **Enrollment Invitation:** Send an enrollment invitation or invitation link to users.
- **Self Help Portal:** Set up a portal that users can visit to download Secure Hub and enroll their devices or send themselves an enrollment invitation.
- **Manual Enrollment:** Send out an email, handbook, or some other communication letting users know that the system is up and that they can enroll. Users then download Secure Hub and enroll their devices manually.
- **Enterprise:** Another option for device enrollment is through the Apple Device Enrollment Program (DEP) and Google Android for Work. Through each of these programs, you can purchase devices that are pre-configured and ready for employees to use. For more information, see [Apple Device Enrollment Program \(DEP\)](#) and [Google Android for Work](#).

You can email an enrollment invitation to users with iOS, macOS, or Android devices. You can also send an installation link through SMTP or SMS to users with iOS, macOS, Android, or Windows devices. For more information, see [Enroll devices](#).

If you choose to use the enrollment invitation method: You can choose from up to seven enrollment modes (depending on platform), and you can use any combination of the modes. You can enable or disable the modes from the XenMobile Settings page, and you can select a default from Username + Password, Two Factor, and Username + PIN. For information on each enrollment mode, see [To configure enrollment modes](#) in the XenMobile documentation.

If you choose certificate-based, consider excluding Username + Password traditional authentication from the allowed options, because this mode may expose a weak onboarding vector into your environment and potentially void the mandated security quality.

Invitations serve many purposes. The most common use of invitations is to notify users that the system is available, and that they can enroll. Invitation URLs are unique; once a user uses an invitation URL, the URL cannot be used again. You can use this property to limit the users or devices enrolling to your system.

You can set up XenMobile so that iOS users provide credentials during enrollment in one of the following ways:

- Users type their credentials during enrollment.
- Users insert a smart card from a derived credentials provider into a reader attached to their desktop. For information about derived credentials, see [Derived credentials for iOS](#).

In the XenMobile console, you can also choose the option for Enrollment Profiles, through which you can control the number of devices specific users can enroll, based on Active Directory groups. For instance, if you want to allow your Finance division only one device per user, you can configure that scenario through enrollment profiles.

Be aware of the extra costs and pitfalls of certain enrollment options. If you want to send invitations using SMS, you need

to set up an additional infrastructure. For more information on this option, see [Notifications](#) in the XenMobile documentation.

In addition, if you plan to send invitations by email, ensure that users have a way of accessing email outside of Secure Hub. You may use one-time password (OTP) enrollment modes as an alternative to Active Directory passwords for MDM enrollment. Note that OTP is available on iOS and Android devices only and is not currently available on Windows devices.

Users can request an enrollment invitation through the Self Help Portal. The default mode is Username + Password, but you can also change that requirement to Two Factor or Username + PIN. For information about setting up the Self Help Portal, see [To configure enrollment modes and the Self Help Portal](#) in the XenMobile documentation.

With manual enrollment, users connect to XenMobile either through autodiscovery or by entering the server information. With autodiscovery, users log on to the server with only their email address or Active Directory credentials in User Principal Name format. Without autodiscovery, they must enter the server address and their Active Directory credentials. For more information about setting up autodiscovery, see [XenMobile Autodiscovery Service](#) in the XenMobile documentation.

You can facilitate manual enrollment in a number of ways. You can create a guide, distribute it to users, and have them enroll themselves. You can have your IT department manually enroll groups of users in certain time slots. You can use any similar method where users must enter their credentials and/or server information.

User Onboarding

After you have your environment set up, you need to decide how to get users into your environment. An earlier section in this article discusses the specifics of user enrollment modes. This section discusses the way you reach out to users.

When onboarding users, you can allow enrollment through two basic methods: You can allow open enrollment in which, by default, any user with LDAP credentials and the XenMobile environment information can enroll. Or, you can limit the number of users by only allowing users with invitations to enroll. You can also limit open enrollment by Active Directory group.

With the invitation method, you can also limit the number of devices a user can enroll. In most situations, open enrollment is acceptable, but there are a few things to consider:

- If you are rolling out a MAM environment, you can easily limit enrollment through Active Directory group membership.
- With an MDM environment, the only way to limit enrollment is to limit the number of devices that can enroll based on Active Directory group membership. If you only allow corporate devices in your environment, this shouldn't be an issue. You may want to consider this method, however, in a BYOD workplace where you want to limit the number of devices in your environment.
- You also want to keep in mind whether you have user or device licenses. With user licenses, each user can have multiple devices and only one license is consumed. With device licenses, each device enrolled consumes one license.

Selective invitation is typically performed less often because it requires a bit more work than open enrollment. In order for users to enroll their devices in your environment, you must send an invitation unique to each user. For information on how to send an enrollment invite, see [Sending an enrollment invitation](#) in the XenMobile documentation.

You'll need to send an invite for each user or group whom you want enrolled in your environment, which can take a long time depending on the size of your organization. It is possible to use Active Directory groups to create invitations in batches, but you must carry out this approach in waves.

When you have decided whether you want to use open enrollment or selective invitation and have set up those environments, you'll need to make users aware of their enrollment options.

If you use the selective invitation method, email and SMS messages are a part of the process. You can send emails through the XenMobile console for open enrollment as well. For details, see [Sending an enrollment invitation](#) in the XenMobile documentation.

In either case, keep in mind that for email, you need an SMTP server. For text messages, you need an SMS server. These may be extra costs to consider when making your decision. In addition, before you select a method, consider how you expect new users to access information, like email. If you want all users to access their email through XenMobile, sending them an invitation email would be problematic.

You may also send communication by another means outside of XenMobile for an open enrollment environment, as long as you include all the relevant information, such as where users can get the Secure Hub app and what method they should use to enroll. If you have autodiscovery turned off, you need to tell them the XenMobile server address as well. To learn more about autodiscovery, see [XenMobile Autodiscovery Service](#) in the XenMobile documentation.

Tuning XenMobile Operations

Jun 21, 2017

The performance and stability of XenMobile operations involves many settings across XenMobile and depends on your NetScaler and SQL Server database configuration. This article focuses on the settings that are most often configured, related to the tuning and optimization of XenMobile. Citrix recommends that you evaluate each of the settings in this article before deploying XenMobile.

Important

These guidelines assume that the XenMobile server CPU and RAM is adequate for the number of devices. For more information about scalability, see [Scalability and performance](#) in the XenMobile documentation.

The following server properties globally apply to operations, users, and devices across an entire XenMobile instance. Be aware that a change to some server properties requires a restart of each XenMobile server node. XenMobile notifies you when a restart is required.

These tuning guidelines apply to both clustered and non-clustered environments.

Settings	Up to 5,000 devices	5,000 to 10,000 devices	More than 10,000 devices
hibernate.c3p0.max_size	200	500	1000
<p>This XenMobile server property, Custom Key, determines the maximum number of connections that XenMobile can open to the SQL Server database. XenMobile uses the value you specify for this custom key as an upper limit; the connections open only if you need them. Base your settings on the capacity of your database server. Default is 1000.</p> <p>To change this setting, you must add a server property to XenMobile server with the following configuration:</p> <p>Key: Custom Key</p> <p>Key: hibernate.c3p0.max_size</p> <p>Value: 500</p> <p>Display name:</p>			<p>Note: In high load situations, such as a very large deployment, consider setting this key to 1000 to better handle the extra load when a large number of devices connect simultaneously.</p>

hibernate.c3p0.max_size= *nnn*

Description: **DB connections to SQL**

Note the following equation in a clustered configuration. Your c3p0 connection multiplied by the number of nodes equals your actual maximum number of connections that XenMobile can open to the SQL Server database.

In clustered and non-clustered configuration, setting the value too high with an undersized SQL Server can cause resource issues on the SQL side during peak load. Setting the value too low means you might not be able to take advantage of the SQL resources available.

hibernate.c3p0.timeout

This XenMobile server property, Custom Key, determines the idle time-out. Default is 300.

Key: **Custom Key**

Key: **hibernate.c3p0.timeout**

Value: **30**

Display name:

hibernate.c3p0.timeout=30

Description: **Database idle timeout**

If you use database cluster failover, Citrix recommends that you add this Custom Key and set it to reduce the idle time-out to about **30** seconds.

Push Services Heartbeat Interval	23 hours	23 hours	7 days
---	----------	----------	--------

This setting determines how frequently an iOS device checks if an APNs notification is not delivered in the interim. Increasing the APNs heartbeat frequency can optimize database communications. Too large a value can add unnecessary load. This setting applies only to iOS.

Default is 6 hours.

If you have a large number of iOS devices in your environment, the heartbeat interval can lead to higher load than necessary. Security actions, such as selective wipe, lock, full wipe, and so on do not rely on this heartbeat, as an APNs notification is sent to the device when these actions are executed. This value governs how quickly a policy updates after Active Directory Group membership changes. As such, it is often suitable to increase this value to something between 12 and 23 hours to reduce load.

iOS MDM APNS Connection Pool Size

Recommended setting is 10 or up to the maximum number of APNs servers for your geographic location.

An APNs connection pool that is too small can negatively affect APNs activity performance when you have more than 100 devices. Performance issues include slower deployment of apps and policies to devices and slower device registration. Default is blank, meaning 1.

Server Property

Default Setting

Why Change This Setting?

Interval for check deleted Active Directory user

0 minutes

The default value 0 prevents XenMobile from checking for deleted Active Directory users. Increase this value to match your Active Directory sync setting. The standard sync time for Active Directory is 15 minutes.

Background Deployment

360 minutes

The frequency for background policy deployments, in minutes. Applies only to always-on connections for Android devices. Increasing the frequency of policy deployments reduces server load. Recommended setting is 1440 (24 hours).

Background Hardware Inventory	360 minutes	The frequency for background hardware inventory, in minutes. Applies only to always-on connections for Android devices. Increasing the frequency of hardware inventory reduces server load. Recommended setting is 1440 (24 hours).
Custom keys: auth.ldap.connect.timeout=60000	6000	To compensate for slow LDAP responses, Citrix recommends that you add server properties for the following Custom Keys.
auth.ldap.read.timeout=60000		<p>Key: Custom Key Key: auth.ldap.connect.timeout Value: 60000 Display name: auth.ldap.connect.timeout=60000 Description: LDAP connection timeout</p> <p>Key: Custom Key Key: auth.ldap.read.timeout Value: 60000 Display name: auth.ldap.read.timeout=60000 Description: LDAP read timeout</p>

You can schedule deployments for Android devices using the Google Firebase Cloud Messaging (FCM, previously named Google Cloud Messaging) or XenMobile settings.

If using FCM to schedule deployments

Enabling FCM for your XenMobile environment allows for near real-time notifications to Android devices, similar to APNs for iOS devices. With FCM configured, when XenMobile needs to connect to a device for a policy update, selective wipe, and so on, the XenMobile server sends a notification message to the FCM server to forward the request to the client device. After the device receives the notification from FCM, the device connects back to XenMobile for further instructions. Keep in mind that this method relies on third-party servers (Google) and therefore is subject to service interruptions outside the control of your IT department or Citrix Support.

For information on how to register with the FCM service, refer to [XenMobile and Firebase Cloud Messaging \(FCM\) Configuration](#).

If using FCM for Android, be aware of the following XenMobile server properties. The properties still use the prior acronym for Google Cloud Messaging, GCM.

- **GCM API Key:** The key created in the Google Developers Console.
- **GCM Sender ID:** The Project Number in the Google Developers Console.
- **GCM Registration ID TTL:** The delay, in days, before renewing the device FCM registration ID. Defaults to **10**.
- **GCM Heartbeat Interval:** Defaults to **6** hours.

If using XenMobile settings to schedule deployments

To schedule deployments to Android devices, use these XenMobile settings:

- Set the **Connection Scheduling Policy** (a XenMobile device policy) to **Always**, which keeps the connection alive permanently. This enables you to deploy policies to delivery groups immediately. The open connection also enables the background services defined in the server properties **Background Deployment** and **Background Hardware Inventory** to occur per those property settings.
- Select the **Deployment Schedule** option **Deploy for always-on connection** in each policy deployed to the device.

Note

For Android devices, setting the **Deployment condition** to **Only when previous deployment has failed** helps with device usage, because some devices overwrite the policy and some devices reset the policy. If a device resets the policy, XenMobile might prompt users for credentials every time a policy that requires authentication is re-deployed. Enabling this feature also helps with server load and prevents the success reported from bouncing between failed and success when XenMobile pushes the policy every time the device connects.

App Provisioning and Deprovisioning

Jun 21, 2017

Application provisioning revolves around mobile app lifecycle management, which mainly consists of wrapping, configuring, delivering, and managing mobile apps within a XenMobile environment. In some instances, developing or modifying application code may also be part of the provisioning process. XenMobile is equipped with various tools and processes that you can use for app provisioning.

Before you read this article on app provisioning, it is recommended that you read the articles on [Apps](#) and [User Communities](#). When you have finalized the type of apps your organization plans to deliver to users, you can then outline the process for managing the apps throughout their lifecycle.

Consider the following points when defining your app provisioning process:

- **App profiling:** Your organization may start with a limited number of apps; however, the number of apps you manage could rapidly increase as user adoption rates increase and your environment grows. You should define specific app profiles right from the beginning in order to make app provisioning easy to manage. App profiling helps you categorize apps into logical groups from a nontechnical perspective. For example, you can create app profiles based on the following factors:
 - Version: App version for tracking
 - Instances: Multiple instances that are deployed for different set of users, for example, with different levels of access
 - Platform: iOS, Android, or Windows
 - Target Audience: Standard users, departments, C-level executives
 - Ownership: Department that owns the app
 - Type: MDX, Public, Web and SaaS, or Web links
 - Upgrade Cycle: How often the app is upgraded
 - Licensing: Licensing requirements and ownership
 - MDX Policies: Wrapped or unwrapped with MDX security policies
 - Network Access: Type of access, such as secure browse or full VPN

Example:

Factor	Secure Mail	Secure Mail	In-House	Epic Rover
Version	10.1	10.1	X.x	X.x
Instance	VIP	Physicians	Clinical	Clinical
Platform	iOS	iOS	iOS	iOS
Target Users	VIP Users	Physicians	Clinical Users	Clinical Users
Ownership	IT	IT	IT	IT

Type	MDX	MDX	Native	Public
Upgrade Cycle	Quarterly	Quarterly	Yearly	N/A
Licensing	N/A	N/A	N/A	VPP
MDX Policies	Yes	Yes	Yes	No
Network Access	VPN	VPN	VPN	Public

- **App versioning:** Maintaining and tracking app versions is a critical part of the provisioning process. Versioning is usually transparent to users. They only receive notifications when a new version of the app is available for download. From your perspective, reviewing and testing each app version in a non-production capacity is also critical in order to avoid production impact.

It is also important to evaluate if a specific upgrade is actually required. App upgrades are usually of two types: One is a minor upgrade, such as a fix to a specific bug; the second is a major release, which introduces significant changes and improvements to the app. In either case, you should carefully review the release notes of the app to evaluate if the upgrade is necessary.

- **App signing and wrapping:** With XenMobile, you can use MDX policies with managed apps to secure the corporate data through app wrapping. For more information about the MDX Toolkit for app wrapping, see [MDX Toolkit](#) in the XenMobile documentation. The app provisioning process for a wrapped app is significantly different from the provisioning process for a standard non-wrapped app.
- **App security:** You define security requirements of individual apps or app profiles as part of the provisioning process. You can map security requirements to specific MDM or MAM policies prior to deploying the apps, which greatly simplifies and expedites app deployment. You may deploy certain apps differently, or you may need to make architectural changes to your XenMobile environment depending on the type of security compliance that the apps require. For example, you may want the device to be encrypted in order to allow the use of a critical business intelligence app, or a certain app may require end-to-end SSL encryption or geo-fencing.
- **App delivery:** XenMobile allows you to deliver apps as MDM apps or as MAM apps. The MDM apps appear in the XenMobile Store. This store allows you to conveniently deliver public or native apps to users without controlling the app apart from enforcing device level restrictions. On the other hand, the MAM mode of delivering apps allows full control over app delivery and over the app itself. Delivering the apps in MAM mode is more suitable in most cases in which you have an on-premises XenMobile deployment with app management requirements along with MDM. When you deliver apps in MAM mode, the mobile device must be enrolled either into XME (MDM+MAM) or MAM-only mode.
- **Application maintenance:**
 - Perform an initial audit: You should keep track of the app version that is present in your production environment, as well as the last upgrade cycle. Make note of specific features or bug fixes that required the upgrade to take place.
 - Establish baselines: You should maintain a list of the latest stable release of each app. This app version should be fall back in case unexpected issues occur post upgrade. You should also device a rollback plan. You should test app upgrades in a test environment prior to your production deployment; if possible, you should deploy the upgrade to a subset of production users first and then to the entire user base.

- Subscribe to Citrix software update notifications and any third-party software vendor notifications: This is critical in order to keep up to date with the latest release of the apps. In some cases, an early access release (EAR) build may also be available for testing ahead of time.
- Devise a strategy to notify users: You should define a strategy to notify users when app upgrades are available. Prepare users with training prior to deployment. You may send multiple notifications prior to updating the apps. Depending on the app, the best notification method might be email notifications or web sites.

App lifecycle management represents the completed lifecycle of an app from its initial deployment through the retirement of the app. The lifecycle of an app can be broken down into these five phases:

1. Requirements for specifications: Start with business case and user requirements.
2. Development: Validate that the app meets business needs.
3. Testing: Identify test users, issues, and bugs.
4. Deployment: Deploy the app to production users.
5. Maintenance: Update app version. Deploy the app in a test environment before updating the app in a production environment.

Application Lifecycle Example Using Secure Mail

1. Requirements for specifications: As a security requirement, you require a mail app that is containerized and supports MDX security policies.
2. Development: Validate that the app meets business needs. You must be able to apply MDX policy controls to the app.
3. Testing: Assign Secure Mail to a test users group and deploy the corresponding MDX file from the XenMobile Server. The test users validate that they can successfully send and receive email, and have calendar and contact access. The test users also report issues and identify bugs. Based on the test users' feedback you optimize Secure Mail configuration for production use.
4. Deployment: When the testing phase is complete, you assign Secure Mail to production users and deploy the corresponding MDX file from XenMobile Server.
5. Maintenance: A new update to Secure Mail is available. You download the new MDX file from Citrix downloads and replace the existing MDX file on the XenMobile Server. Instruct the users to perform the update. Note: Citrix recommends that you complete and test this process in a test environment before uploading the app to a XenMobile production environment and deploying the app to users.

For more information, see [Wrapping iOS Mobile Apps](#) and [Wrapping Android Mobile Apps](#) in the XenMobile documentation.

Dashboard-Based Operations

Jun 21, 2017

You can view information at a glance by accessing your XenMobile console dashboard. With this information, you can see issues and successes quickly by using widgets.

The dashboard is usually the screen that appears when you first sign on to the XenMobile console. To access the dashboard from elsewhere in the console, click **Analyze**. Click **Customize** on the dashboard to edit the layout of the page and to edit the widgets that appear.

- **My Dashboards:** You can save up to four dashboards. You can edit these dashboards separately and view each one by selecting the saved dashboard.
- **Layout Style:** In this row, you can select how many widgets appear on your dashboard and how the widgets are laid out.
- **Widget Selection:** You can choose which information appears on your dashboard.
 - **Notifications:** Mark the check box above the numbers on the left to add a Notifications bar above your widgets. This bar shows the number of compliant devices, inactive devices, and devices wiped or enrolled in the last 24 hours.
 - **Devices By Platform:** Displays the number of managed and unmanaged devices by platform.
 - **Devices By Carrier:** Displays the number of managed and unmanaged devices by carrier. Click each bar to see a breakdown by platform.
 - **Managed Devices By Platform:** Displays the number of managed devices by platform.
 - **Unmanaged Devices By Platform:** Displays the number of unmanaged devices by platform. Devices that appear in this chart may have an agent installed on them, but have had their privileges revoked or have been wiped.
 - **Devices By ActiveSync Gateway Status:** Displays the number of devices grouped by ActiveSync Gateway status. The information shows Blocked, Allowed, or Unknown status. You can click each bar to break down the data by platform.
 - **Devices By Ownership:** Displays the number of devices grouped by ownership status. The information shows corporate-owned, employee-owned, or unknown ownership status.
 - **Android TouchDown License Status:** Displays the number of devices that have a TouchDown license.
 - **Failed Delivery Group Deployments:** Displays the total number of failed deployments per package. Only packages that have failed deployments appear.
 - **Devices By Blocked Reason:** Displays the number of devices blocked by ActiveSync
 - **Installed Apps:** By using this widget, you can type an app name, and a graph displays information about that app.
 - **VPP Apps License Usage:** Displays license usage statistics for Apple Volume Purchase Program apps.

Use Cases

Some examples for the many ways you can use dashboard widgets to monitor your environment are as follows.

- You have deployed XenMobile Apps and are receiving support tickets regarding XenMobile Apps failing to install on devices. Use the **Out of Compliance Devices** and **Installed Apps** widgets to see the devices that do not have XenMobile Apps installed.
- You'd like to monitor inactive devices so that you can remove the devices from your environment and reclaim licenses. Use the **Inactive Devices** widget to track this statistic.
- You are receiving support tickets concerning data not being synced properly. You may want to use the **Devices by ActiveSync Gateway Status** and **Devices By Blocked Reason** widgets to determine whether the issue is ActiveSync related.

After your environment is set up and users enroll, you can run reports to learn about your deployment. XenMobile comes with a number of reports built in to help you get a better picture of the devices running on your environment. For details, see [Reports](#) in the XenMobile documentation.

Important: Although it is possible to use SQL Server to create custom reports, Citrix does not recommend this method. Using the SQL Server database in this manner may have unforeseen consequences in your XenMobile deployment. If you do decide to pursue this method of reporting, ensure that SQL queries are run using a read-only account.

Role-Based Access Control and XenMobile Support

Jun 21, 2017

XenMobile uses role-based access control (RBAC) to restrict user and group access to XenMobile system functions, such as the XenMobile console, Self Help Portal, Remote Support, and public API. This article describes the roles built in to XenMobile and includes considerations for deciding on a support model for XenMobile that leverages RBAC.

Built-In Roles

You can change the access granted to the following built-in roles and you can add roles. For the full set of access and feature permissions associated with each role and their default setting, download [Role-Based Access Control Defaults](#) from the XenMobile documentation. For a definition of each feature, see [Configure roles with RBAC](#) in the XenMobile documentation.

Roles	Default Access Granted	Considerations
Admin	Full system access except to the Self-Help Portal and Remote Support. By default, administrators can perform some support tasks, such as check connectivity and create support bundles.	Do some or all of your administrators need access to the Self-Help Portal or Remote Support? If so, you can edit the Admin role or add Admin roles. To restrict access further for some administrators or administrator groups, add roles based on the Admin template and edit the permissions.
Device Provisioning	Access to the XenMobile console to perform basic administration on Windows CE devices: add, change, and remove devices; use the Settings page.	The Device Provisioning role applies only to Windows CE devices.
Support	Access to Remote Support.	The Remote Support feature is available only for Windows and Android KNOX devices, in on-premises deployments.
User	Access to the Self-Help Portal, which lets authenticated users generate enrollment links. The links allow them to enroll their devices or send themselves an enrollment invitation. Restricted access to the XenMobile console: device features (such as wipe, lock/unlock device; lock/unlock container; see location and set geographic restrictions; ring the device; reset container password); add, remove,	The User role enables you to enable users to help themselves. To support shared devices, create a user role for shared device enrollment.

and send enrollment invitations.

Considerations for a XenMobile Support Model

The support models that you can adopt can vary widely and might involve third parties who handle level 1 and 2 support while employees handle level 3 and 4 support. Regardless of how you distribute the support load, keep in mind the considerations in this section specific to your XenMobile deployment and user base.

Do users have corporate-owned or BYO devices?

The primary question that influences support is who owns the user devices in your XenMobile environment. If your users have corporate-owned devices, you might offer a lower level of support, as a way to lock down the devices. In that case, you might provide a help desk that assists users with device issues and how to use the devices. Depending on the types of devices you need to support, consider how you might use the RBAC Device Provisioning and Support roles for your help desk.

If your users have BYO devices, your organization might expect users to find their own sources for device support. In that case, the support your organization provides is more of an administrative role focused around XenMobile-specific issues.

What is your support model for desktops?

Consider whether your support model for desktops is appropriate for other corporate-owned devices. Can you use the same support organization? What additional training will they need?

Do you want to give users access to the XenMobile Self Help Portal?

Although some organizations prefer not to grant users access to XenMobile, giving users some self-support capabilities can ease the load on your support organization. If the default User role for RBAC includes permissions that you don't want to grant, consider creating a new role with only the permissions you want to include. You can create as many roles as needed to meet your requirements.

Systems Monitoring

Jun 21, 2017

To ensure optimal uptime for app access and connectivity, you should monitor the following core components in the XenMobile environment:

XenMobile server

XenMobile server generates and stores logs on local storage that you can also export to a systems log (syslogs) server. You can configure log settings to specify size constraints, log level, or you can create custom loggers to filter specific events. You can look at XenMobile server logs from the XenMobile console at any time. You can also export information in the logs via the syslog server to your production Splunk logging servers.

The following list describes the different types of log files available in XenMobile:

Debug log file: Contains debug level information about core web services of XenMobile, including error messages and server-related actions.

Message format:

<date> <timestamp> <loglevel> <class name (including the package)> - <id> <log message>

- where <id> is a unique identifier like sessionId.
- where <log message> is the message supplied by the application.

Admin audit log file - Contains audit information about activity on the XenMobile console.

Note: The same format is used for both admin audit and user audit logs.

Message format:

With the exception of required Date and Timestamp values, all other attributes are optional. Optional fields are represented with " " in the message.

<date> <timestamp> "<username/id>" "<sessionid>" "<deviceid>" "<clientip>" "<action>" "<status>"

"<application name>" "<app user id>" "<user agent>" "<details>"

The following table lists the available admin audit log events:

Admin Audit Log Messages	
Event	Status
Login	success/failure
Logout	success/failure

Event	Status
Update admin	success/failure
Get application	success/failure
Add application	success/failure
Update application	success/failure
Delete application	success/failure
Bind application	success/failure
Unbind application	success/failure
Disable application	success/failure
Enable application	success/failure
Get category	success/failure
Add category	success/failure
Update category	success/failure
Delete category	success/failure
Add certificate	success/failure
Delete certificate	success/failure
Active certificate	success/failure
Self-sign certificate	success/failure
CSR certificate	success/failure

Event	Status
Export certificate	success/failure
Delete certificate chain	success/failure
Add certificate chain	success/failure
Get connector	success/failure
Add connector	success/failure
Delete connector	success/failure
Update connector	success/failure
Get device	success/failure
Lock device	success/failure
Unlock device	success/failure
Wipe device	success/failure
Unwipe device	success/failure
Delete device	success/failure
Get role	success/failure
Add role	success/failure
Update role	success/failure
Delete role	success/failure
Bind role	success/failure
Unbind role	success/failure

Event	Status
Update config settings	success/failure
Update workflow email	success/failure
Add workflow	success/failure
Delete workflow	success/failure
Add Active Directory	success/failure
Update Active Directory	success/failure
Add masteruserlist	success/failure
Update masteruserlist	success/failure
Update DNS	success/failure
Update Network	success/failure
Update log server	success/failure
Transfer log from log server	success/failure
Update syslog	success/failure
Update receiver updates	success/failure
Update time server	success/failure
Update trust	success/failure
Add service record	success/failure
Update service record	success/failure
Update receiver email	success/failure

Event	Status
Upload patch	success/failure
Import snapshot	success/failure
Fetch app store app details	success/failure
Update MDM	success/failure
Delete MDM	success/failure
Add HDX	success/failure
Update HDX	success/failure
Delete HDX	success/failure
Add Branding	success/failure
Delete Branding	success/failure
Update SSL offload	success/failure
Add account property	success/failure
Delete account property	success/failure
Update account property	success/failure
Add beacon	success/failure

User audit log file: Contains information related to the user activity from enrolled devices.

Note: The same format is used for both user audit and admin audit logs.

Message format:

With the exception of required Date and Timestamp values, all other attributes are optional. Optional fields are represented with " " in the message. For example,

<date> <timestamp> " <username/id>" "<sessionid>" "<deviceid>" "<clientip>" "<action>" "<status>" " <application name>" " <app user id>" "<user agent>" "<details>"

The following table lists the available user audit log events:

User Audit Log Messages	
Event	Status
Login	success/failure
Session time-out	success/failure
Subscribe	success/failure
Unsubscribe	success/failure
Pre-launch	success/failure
AGEE SSO	success/failure
SAML Token for ShareFile	success/failure
Device registration	success/failure
Device check	lock/wipe
Device update	success/failure
Token refresh	success/failure
Secret saved	success/failure
Secret retrieved	success/failure
User initiated change password	success/failure
Mobile client download	success/failure

Event	Status
Logout	success/failure
Discovery Service	success/failure
Endpoint Service	success/failure
MDM Functions	
REGHIVE	success/failure
Cab inventory	success/failure
Cab	success/failure
Cab auto install	success/failure
Cab shell install	success/failure
Cab create folder	success/failure
Cab file get	success/failure
File create folder	success/failure
File get	success/failure
File sent	success/failure
Script create folder	success/failure
Script get	success/failure
Script sent	success/failure
Script shell execution	success/failure

MDM Functions	
APK inventory	success/failure
APK	success/failure
APK shell install	success/failure
APK auto install	success/failure
APK create folder	success/failure
APK file get	success/failure
APK App	success/failure
EXT App	success/failure
List get	success/failure
List sent	success/failure
Locate device	success/failure
CFG	success/failure
Unlock	success/failure
SharePoint wipe	success/failure
SharePoint Configuration	success/failure
Remove profile	success/failure
Remove application	success/failure
Remove unmanaged application	success/failure

MDM Functions	
IPA App	success/failure
EXT App	success/failure
Apply redemption code	success/failure
Apply settings	success/failure
Enable tracking device	success/failure
App management policy	success/failure
SD card wipe	success/failure
Encrypted email attachment	success/failure
Branding	success/failure
Secure browser	success/failure
Container browser	success/failure
Container unlock	success/failure
Container password reset	success/failure
AG client auth creds	success/failure

NetScaler also monitors the XenMobile web service state, which is configured with intelligent monitoring probes to simulate HTTP requests to each XenMobile server cluster node. The probes determine whether the service is online and then respond based on the response received. In the event that a node does not respond as expected, NetScaler marks the server as down. In addition, NetScaler takes the node out of the load-balancing pool and logs the event for use in generating alerts through the NetScaler monitoring solution.

You can also use standard hypervisor monitoring tools to monitor the XenMobile virtual machines and to provide relevant alerts regarding CPU, memory, and storage utilization metrics.

SQL Server and database

SQL Server and database performance directly affects XenMobile services. The XenMobile instance requires access to the database at all times and goes offline (for example, stops responding) in the event of an outage to the SQL infrastructure. The XenMobile console may continue to function for a while following any disk space issues with SQL Server. To ensure maximum database uptime and adequate performance for the XenMobile workload, you should proactively monitor the state of your SQL Servers following [Microsoft recommendations](#). Additionally, you should adjust resource allocation for CPU, memory, and storage to guarantee service level agreements as your XenMobile environment continues to grow.

NetScaler

NetScaler provides the ability to log metrics to internal storage or to send logs to an external logging server. You can configure the syslog server to export NetScaler logs to your production Splunk logging servers. The following logging levels are available in NetScaler:

- Emergency
- Alert
- Critical
- Error
- Warning
- Information

The log files are also stored in NetScaler storage in the `/var/log/ns.log` directory and named `newslog`. NetScaler rolls over and compresses the files by using the GZIP algorithm. Log file names are `newslog.xx.gz`, where `xx` represents a running number.

NetScaler also supports SNMP traps and alerts as a monitoring option. The following table lists the SNMP traps recommended for the environment.

NetScaler SNMP traps	
Configuration	Setting
cpuUtilization 1.3.6.1.4.1.5951.1.1.0.3	This trap indicates that the CPU utilization has exceeded the high threshold.
averageCpuUtilization 1.3.6.1.4.1.5951.1.1.0.51	This trap indicates that the average CPU usage in the multi-processor NetScaler system has exceeded the high threshold.
memoryUtilization 1.3.6.1.4.1.5951.1.1.0.13	This trap is sent when the memory utilization of the system exceeds the threshold value.
netScalerLoginFailure 1.3.6.1.4.1.5951.1.1.0.55	This trap is sent when a logon attempt to NetScaler fails.
diskUsageHigh 1.3.6.1.4.1.5951.1.1.0.64	This trap indicates that disk usage has gone high.
haSyncFailure 1.3.6.1.4.1.5951.1.1.0.69	This trap indicates that configuration synchronization has failed on the secondary instance.

1.3.6.1.4.1.5951.1.1.0.70 Configuration	This trap indicates that high availability heartbeats are not received from the secondary instance.
haBadSecState 1.3.6.1.4.1.5951.1.1.0.71	This trap indicates that the secondary instance is in DOWN/UNKNOWN/STAY SECONDARY state.
haPropFailure 1.3.6.1.4.1.5951.1.1.0.85	This trap indicates that configuration propagation has failed on the secondary instance.
ipConflict 1.3.6.1.4.1.5951.1.1.0.86	This trap indicates that an IP address conflict is present with another device in the network.

Disaster Recovery

Jun 21, 2017

You can architect and configure XenMobile deployments that include multiple sites for disaster recovery using an active-passive failover strategy.

The recommended disaster recovery strategy discussed in this article consists of:

- A single XenMobile active site in the datacenter of one geographical location serving all the enterprises users globally, known as the primary site.
- A second XenMobile site in the datacenter of a second geographical location, known as the disaster recovery site. This disaster recovery site provides active-passive site failover in if a site-wide datacenter failure occurs in the primary site. The primary site includes XenMobile, SQL database, NetScaler infrastructure in order to facilitate failover and provide users with access to XenMobile via the event of connectivity failure to the primary site.

The XenMobile servers at the disaster recovery site remains offline during normal operations and is brought online during only disaster recovery scenarios, where complete site failover from the primary site to the disaster recovery site is required. The SQL Servers at the disaster recovery site must be active and ready to service connections before you start the XenMobile servers at the disaster recovery site.

This disaster recovery strategy relies on manual failover of the NetScaler access tier by means of DNS changes for routing MDM and MAM connections to the disaster recovery site in the event of an outage.

Note

To use this architecture, you must have a process in place for asynchronous backups of the databases and some way of ensuring high availability for the SQL infrastructure.

Disaster Recovery Failover Process

1. If you are testing your disaster recovery failover process, shut down XenMobile servers in the primary site to simulate site failure.
2. Change public DNS records for the XenMobile servers to point to the disaster recovery site's external IP addresses.
3. Change internal DNS record for the SQL Server to point to the disaster recovery site's SQL Server IP address.
4. Bring XenMobile SQL databases online at the disaster recovery site. Ensure that the SQL Server and database is active and ready to service connections from the XenMobile servers local to the site.
5. Turn on the XenMobile servers on the disaster recovery site.

XenMobile Server Update Process

Follow these steps any time you update XenMobile with patches and releases, in order to keep the code of the primary and disaster recovery servers uniform.

1. Ensure that XenMobile servers in primary site have been patched or upgraded.
2. Ensure that DNS record for the SQL Server is resolving to the active SQL Server database in the primary site.
3. Bring the disaster recovery site's XenMobile servers online. The servers connect to the primary site's database across the WAN during the upgrade process only.
4. Apply required patches and updates to all disaster recovery site's XenMobile servers.
5. Restart the XenMobile servers and confirm that the patch or upgrade is successful.

Disaster Recovery Reference Architecture Diagram

The following diagram shows the high-level architecture for a disaster recovery deployment of XenMobile.

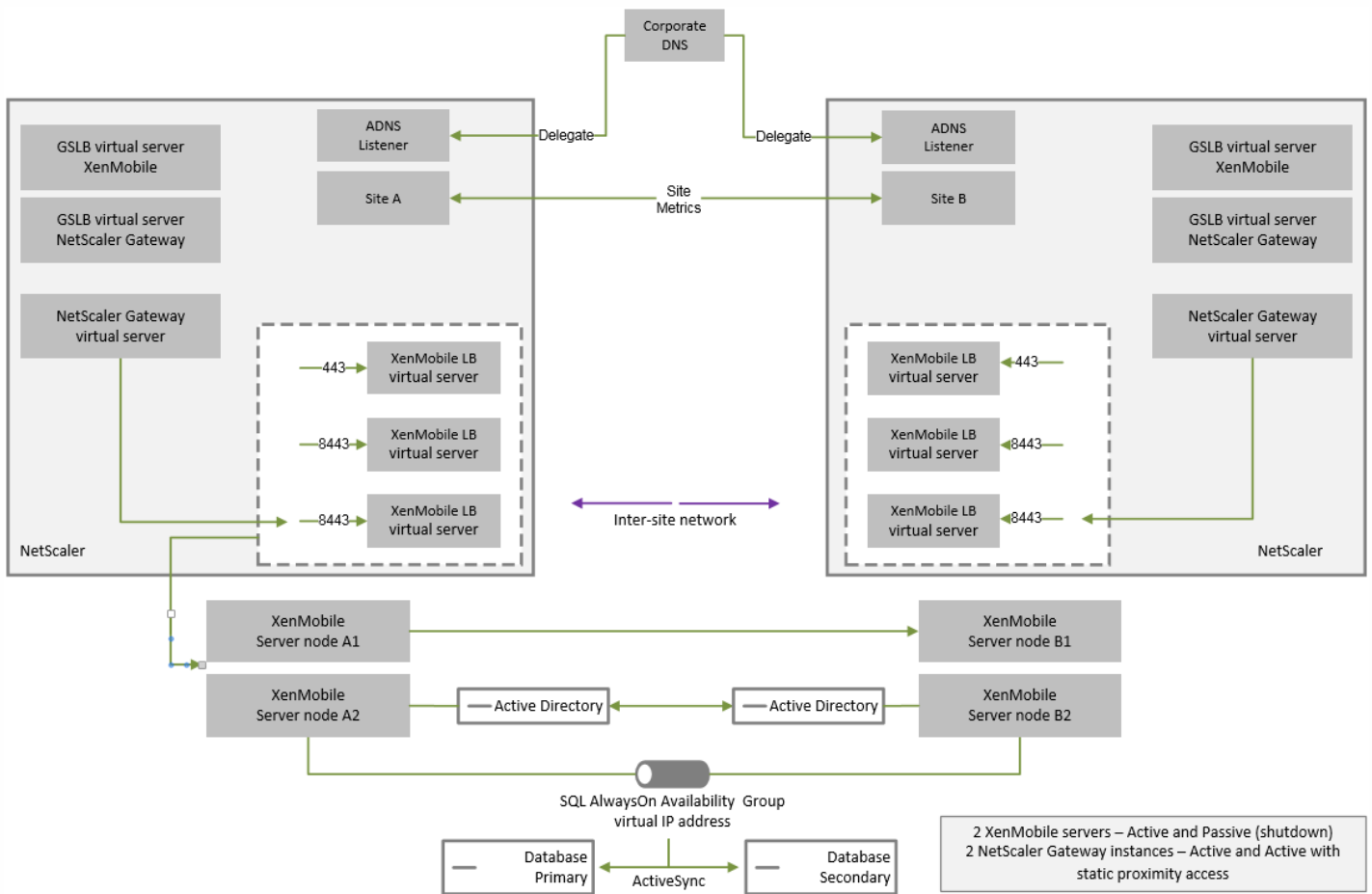

GSLB for Disaster Recovery

A key element of this architecture is the use of Global Server Load Balancing (GSLB) to direct traffic to the correct data center.

By default, the NetScaler for XenMobile wizard configures NetScaler Gateway in a way that does not enable the use of GSLB for disaster recovery. Therefore, you must take additional steps.

GSLB is at its core a form of DNS. Participating NetScaler appliances act as authoritative DNS servers and resolve DNS records to the correct IP address (typically the VIP that is supposed to receive traffic). The NetScaler appliance checks the system health before responding to a DNS query directing traffic to that system.

When a record is resolved, GSLB's role in resolving the traffic is complete. The client communicates directly with the target virtual IP (VIP) address. DNS client behavior plays an important part on controlling how and when a record expires. This is largely outside the boundaries of the NetScaler system. As such, GSLB is subject to the same limitations as DNS name resolution. Clients cache responses; thus, load balancing in this way isn't as real-time as is traditional load balancing.

The GSLB configuration on NetScaler, including sites, services, and monitors, exist in order to provide the correct DNS name resolution.

The actual configuration for publishing servers (in this scenario, the configuration that the NetScaler for XenMobile wizard creates) is not affected by the GSLB. GSLB is a separate service on the NetScaler.

The NetScaler for XenMobile wizard configures NetScaler Gateway for XenMobile. This wizard generates three load balancing virtual servers and a NetScaler Gateway virtual server.

Two of the load balancing virtual servers handle MDM traffic, on port 443 and 8443. NetScaler Gateway receives MAM traffic and forwards it to the third server, the MAM load balancing virtual server, on port 8443. All traffic to the MAM load balancing virtual server is passed through NetScaler Gateway.

The MAM load balancing virtual server requires the same SSL certificate as the XenMobile servers and uses the same FQDN as used to enroll devices. The MAM load balancing server also uses the same port (8443) as one of the MDM load balancing servers. To enable traffic to be resolved, the NetScaler for XenMobile wizard creates a local DNS record on NetScaler Gateway. The DNS record matches the FQDN used to enroll devices.

This configuration is effective when the XenMobile server URL is not a GSLB domain URL. If a GSLB domain URL is used as the XenMobile server URL, as is required for disaster recovery, the local DNS record prevents NetScaler Gateway from resolving traffic to the MDM load balancing servers.

To address the challenges presented by the default configuration created by the NetScaler for XenMobile wizard, you can create a CNAME record for the XenMobile server FQDN in the parent domain (company.com) and point a record in the delegated subzone (gslb.company.com) for which NetScaler is authoritative. Doing so allows for the creation of the static DNS A record for the MAM load balancing VIP address required to resolve traffic.

1. On the external DNS, create a CNAME for the XenMobile server FQDN that points to the GSLB domain FQDN on NetScaler GSLB. You need two GSLB domains: one for MDM traffic and another for MAM (NetScaler Gateway) traffic.

Example: CNAME = xms.company.com IN CNAME xms.gslb.comany.com

2. On the NetScaler Gateway instance of each site, create a GSLB virtual server with a FQDN that is what the CNAME record is pointing to.

Example: bind gslb vserver xms-gslb -domainName xms.gslb.company.com

When using the NetScaler for XenMobile wizard to deploy NetScaler Gateway, use the XenMobile server URL when configuring the MAM load balancing server. This creates a static DNS A record for the XenMobile server URL.

3. Test with clients enrolling on Secure Hub using the XenMobile server URL (xms.company.com).

This example uses the following FQDNs:

- xms.company.com is the URL that is used by the MDM traffic and is used by devices enrolling, which is configured in this example by using the NetScaler for XenMobile wizard.
- xms.gslb.company.com is the GSLB domain FQDN for the XenMobile server.

Citrix Support Process

Jun 21, 2017

You can turn Citrix Technical Support Services to help with issues related to Citrix products. The group offers workarounds and resolutions and works hand in hand with development teams to offer solutions.

Citrix Consulting Services or Citrix Education Services offer help related to product training, advice on product usage, configuration, installation, or environment design and architecture.

Citrix Consulting helps with Citrix product-related projects, including proof of concepts, economic impact assessment, infrastructure health checks, design requirements analysis, architecture design verification, integration, and operational process development.

Citrix Education offers best-in-class IT training and certification on Citrix Virtualization, Cloud, and networking technologies.

Citrix recommends that you take full advantage of the Citrix Self-Help Resources and recommendations before creating a support case. For instance, there are several places where you can access articles and bulletins written by Citrix technical experts, see product documentation for Citrix solutions and technologies, or read straight talk from Citrix executives, product teams, and technical experts. See the [Knowledge Center](#), [Product documentation](#), and [Blogs](#) pages respectively.

For more interactive assistance, you can participate in discussion forums where you can ask questions and get real-world answers from other customers, share ideas, opinions, technical information, and best practices within user groups and interest groups, or interact with Citrix Support engineers who monitor Citrix Support social networking sites. See the [Support Forums](#), [Citrix Community](#), and [Citrix Support on Twitter](#) pages respectively.

You also have access to training and certification courses to build your skills. See [Citrix Education](#).

Citrix Insight Services provides a simple, online troubleshooting platform and health-checker for your Citrix environment. Available for XenMobile, XenDesktop, XenServer, XenApp, and NetScaler. See [Analysis Tool](#).

To seek technical support, you can create a support case either by phone or via the web. You can use the web for low- and medium-severity issues and use the phone option for high-severity issues. For information on contacting support for XenMobile issues, see [How to Contact Support](#).

If you seek a highly trained single point of contact with extensive experience delivering Citrix solutions, Citrix Services offers a Technical Relationship Manager. For more information about Citrix services offering and benefits, see [Citrix Worldwide Services](#).